

This Owner's Manual is provided and hosted by [Appliance Factory Parts](http://Appliance Factory Parts).

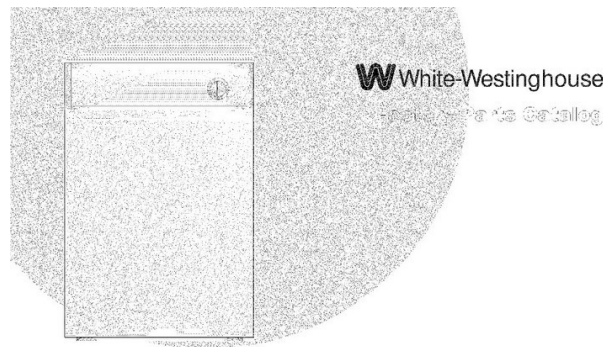

# FRIGIDAIRE wwx121es1 Owner's Manual

[Shop genuine replacement parts for FRIGIDAIRE  
wwx121es1](#)



Product No.	WWX121ES1
Series	White-West
Market	North America
Color	white
Volts	120
Wiring Diagram	134127800
Owner's Guide	134532700
Installation Instructions	134711300
Operating Instructions	134516100
Energy Guide	134515700

 Electrolux Major Appliances North & Latin America P.O. BOX 212278 AUGUSTA, GA 30917	TOP-LOAD WASHING MACHINE  Model No. WWX121E
---	---

Publication No.  
5965474979  
06/07/05  
(EN/SERVICE/WC)  
361

Copyright © 2006 Electrolux Home Products, Inc.  
All rights reserved.

[Find Your FRIGIDAIRE Washer Parts - Select From 478 Models](#)

----- Manual continues below -----

## WASHER

Owner's Guide

## LAVADORA

Manual del Usuario

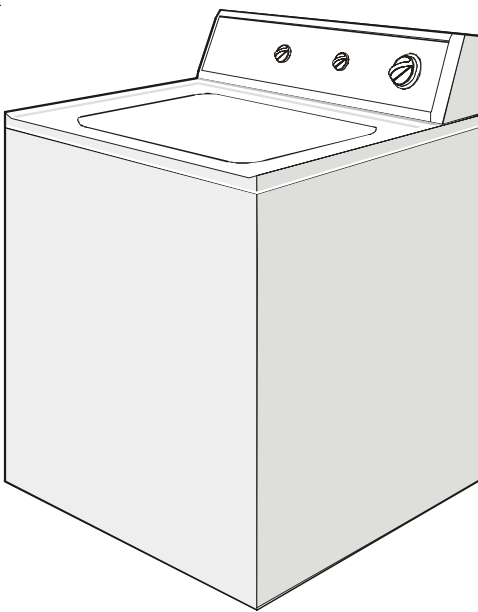

### Contents

Important Safety Instructions .....	2
Washing Procedures .....	3-5
Stain Removal .....	5-6
Common Washing Problems .....	7
Care and Cleaning .....	8
Avoid Service Checklist .....	9-10
Español.....	11-20
Instrucciones Importantes de Seguridad.....	11-12
Procedimientos para el Lavado.....	13-15
Cómo Remover Manchas.....	15-16
Problemas Comunes del Lavado.....	17
Limpeza y Cuidado.....	18
Lista de Control de Averías.....	19-20

#### Product Registration

**Thank you for choosing this washer.** This owner's guide will explain proper operation and care.

#### Register Your Product

The self-addressed **PRODUCT REGISTRATION CARD** should be filled in completely, signed and returned.

#### Registro del Producto

**Le agradecemos que haya seleccionado esta lavadora.** En este manual del usuario encontrará las instrucciones apropiadas para su funcionamiento y cuidado.

#### Registre su Producto

La **TARJETA DE REGISTRO DEL PRODUCTO** ya dirigida debe ser llenada, firmada y enviada.

#### Read and Save These Instructions

#### Record Your Model and Serial Numbers

Record below the model and serial numbers found on the washer serial plate located on the underside of the washer lid. Keep these numbers for future reference.

#### Anote su Número de Modelo y de Serie

Anote a continuación los números de serie y de modelo que se encuentran en la placa de series de la lavadora ubicada en el reverso de la tapa de la lavadora. Guarde estos números para futura referencia.

**Model Number:**

**Número de Modelo:** \_\_\_\_\_

**Serial Number:**

**Número de Serie:** \_\_\_\_\_

**Purchase Date:**

**Fecha de compra:** \_\_\_\_\_

This Owner's Guide provides general operating instructions for your washer. It also contains information about features for several other models. Your washer may not have every feature included here. Use the washer only as instructed in this Owner's Guide and the **Operating Instructions** card included with your washer.

**⚠ WARNING** Avoid fire hazard or electrical shock. Do not use an adaptor plug or extension cord or remove grounding prong from electrical power cord. Failure to follow this warning can cause serious injury, fire or death.

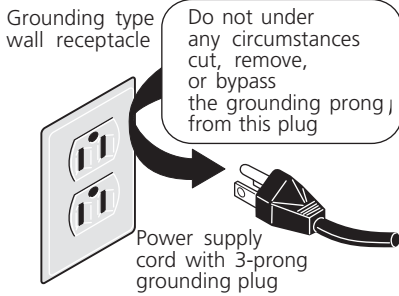

**CORRECT**  
Use this way **ONLY**

**⚠ WARNING** Do not use or mix liquid chlorine bleach with other household chemicals such as toilet cleaners, rust removers, acid or products containing ammonia. These mixtures can produce dangerous fumes which can cause serious injury or death.

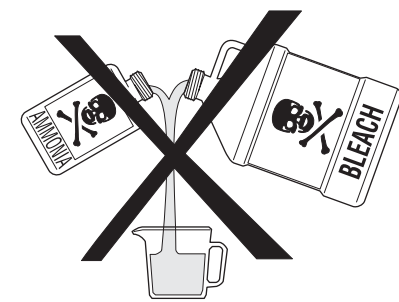

Note: The instructions appearing in this Owner's Guide are not meant to cover every possible condition and situation that may occur. Common sense and caution must be practiced when installing, operating and maintaining any appliance.

**Read all instructions before using this washer.**

**⚠ WARNING** To reduce the risk of fire, electrical shock, or injury to persons when using this washer, comply with the basic warnings listed below.

**⚠** Failure to comply with these warnings could result in serious personal injuries.

### Prevent Fire

**⚠ WARNING** Do not wash items that have been previously cleaned in, soaked in, or spotted with gasoline, cleaning solvents, kerosene, cooking oils, waxes, etc. Do not store these items on or near the washer. These substances give off vapors or chemical reactions that could ignite or explode.

**⚠ WARNING** Do not put oily or greasy rags or clothing on top of the washer. These substances give off vapors that could ignite the materials.

**⚠ WARNING** Do not add gasoline, cleaning solvents, or other flammable or explosive substances to the wash water. These substances give off vapors that could ignite or explode.

**⚠ WARNING** Under certain conditions, hydrogen gas may be produced in a hot water system that has not been used for 2 weeks or more. **HYDROGEN GAS IS EXPLOSIVE.** If the hot water system has not been used for such a period, before using the washer, turn on all hot water faucets and let the water flow from each for several minutes. This will release any accumulated hydrogen gas. Hydrogen gas is flammable; do not smoke or use an open flame during this time.

**⚠** Failure to comply with these warnings could result in fire, explosion, serious bodily injury and/or damage to the rubber or plastic parts of the washer.

### FOR YOUR SAFETY

Do not store or use gasoline or other flammable vapors or liquids in the vicinity of this or any other appliance.

### Protect Children

**⚠ WARNING** Do not allow children to play on or in the washer. Close supervision of children is necessary when the washer is used near children. As children grow, teach them the proper, safe use of all appliances.

**⚠ WARNING** Destroy the carton, plastic bag and other packing materials after the washer is unpacked. Children might use them for play. Cartons covered with rugs, bedspreads or plastic sheets can become airtight chambers.

**⚠ WARNING** Keep laundry products out of children's reach. To prevent personal injury, observe all warnings on product labels.

**⚠ WARNING** Before the washer is removed from service or discarded, remove the washer lid to prevent accidental entrapment.

**⚠** Failure to comply with these warnings could result in serious personal injuries.

### Prevent Injury

**⚠ WARNING** To prevent shock hazard and assure stability during operation, the washer must be installed and electrically grounded by a qualified service person in accordance with local codes. Installation instructions are packed in the washer for installer's reference. Refer to INSTALLATION INSTRUCTIONS for detailed grounding procedures. If the washer is moved to a new location, have it checked and reinstalled by a qualified service person.

**⚠ WARNING** To prevent personal injury or damage to the washer, the electrical power cord of the washer must be plugged into a properly grounded and polarized 3-prong outlet. **The third grounding prong must never be removed. Never ground the washer to a gas pipe. Do not use an extension cord or an adaptor plug.**

**⚠ WARNING** Follow package directions when using laundry products. Incorrect usage can produce poisonous gas--resulting in serious injury or death.

- **Do not** combine laundry products for use in 1 load unless specified on the label.
- **Do not** mix chlorine bleach with ammonia or acids such as vinegar.

**⚠ WARNING** To prevent serious personal injury and damage to the washer:

- **All repairs and servicing must be performed by an authorized servicer** unless specifically recommended in this Owner's Guide. Use only authorized factory parts.
- **Do not** tamper with controls.
- **Do not** install or store the washer where it will be exposed to the weather.

**⚠ WARNING ALWAYS disconnect** the washer from the electrical supply before attempting any service or cleaning. Failure to do so can result in electrical shock or injury.

**⚠ WARNING** To prevent injury, do not reach into the washer while parts are moving. Before loading, unloading or adding items, push in the cycle selector knob and allow the tub to coast to a complete stop before reaching inside.

**⚠** Failure to comply with these warnings could result in serious personal injuries.

**⚠** This washer is equipped with an electrical overload protector. The motor will stop if it becomes overheated. The washer will automatically restart after a cool down period of up to 30 minutes, if the washer has not been manually turned off during this time.

## Washing Procedures

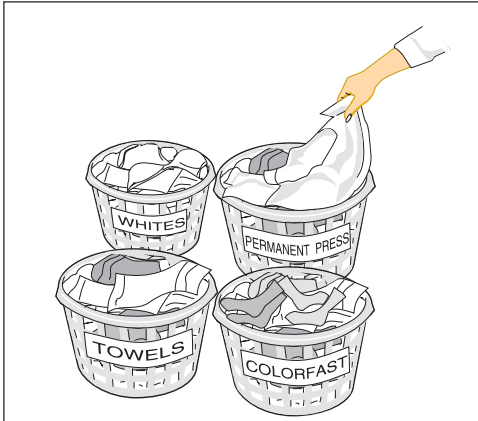

Sort laundry into loads that can be washed together.

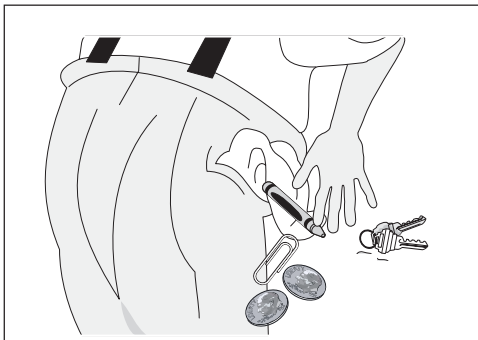

Empty pockets.

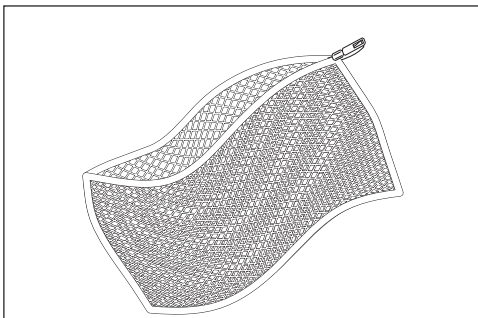

Place delicate items in a mesh bag.

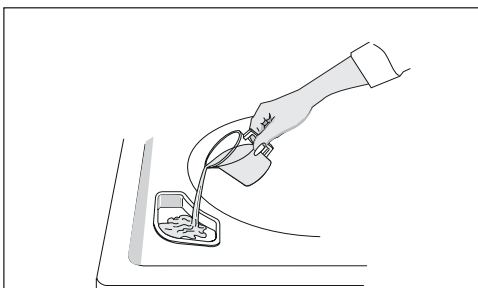

Bleach Dispenser (some models)

- Follow the guidelines below for preparing the wash load.
- Read the **Operating Instructions** card for operating your specific model.
- **Always read and follow fabric care and laundry product labels.**

**⚠ WARNING** To reduce the risk of fire, electrical shock, or injury to persons, read **Important Safety Instructions**, pages 2, before operating this washer.

### 1. Sort laundry into loads that can be washed together.

Sort items by recommended water temperatures, wash time, and agitate/spin speeds.

- Separate white, light, and colorfast items from dark and noncolorfast items.
- Separate items which shed lint from items which attract lint. Permanent press, synthetic, knit and corduroy items will pick up lint from towels, rugs and chenille bedspreads.
- Separate heavily soiled items from lightly soiled items.
- Separate lacy, sheer and loosely knit items from sturdy items.

### 2. Prepare items for washing.

- Empty pockets.
- Brush off lint and dirt. Shake out rugs and beach towels.
- Close zippers, fasten hooks, tie strings and sashes, and remove nonwashable trims and ornaments.
- Remove pins, decorative buttons, belt buckles, and other objects which could be damaged. This also helps protect other items in the wash load.
- Mend rips and tears to prevent further damage during washing.
- Place delicate items such as bras, shoulder pads, hosiery, and belts in a mesh bag to prevent tangling during the wash cycle.
- Turn knit items inside out to prevent pilling.

### 3. Pretreat stains and heavy soil.

See **Stain Removal**, pages 5-6, for details.

### 4. Add a measured amount of detergent to the wash tub before adding the laundry load.

Follow detergent manufacturer's directions. The amount required depends on type of detergent, load size and soil level, and water hardness.

### 5. If desired, add liquid bleach to Bleach Dispenser (some models).

- Before adding the wash load, add liquid bleach to bleach dispenser located in left front corner under the lid:
  - 3/4 cup (180 ml) for small loads
  - 1 cup (240 ml) for large loads
  - 1-1/4 cups (300 ml) for extra-large loads.
- Then add 1 cup (240 ml) water to flush the dispenser.
- Do not use powdered bleach in the bleach dispenser.

**For models without a bleach dispenser**, dilute the recommended amount of liquid chlorine bleach in 1 quart (.95 L) water. Add it to wash water after a few minutes of agitation. **Do not pour bleach directly on wash load.**

## Washing Procedures

(continued)

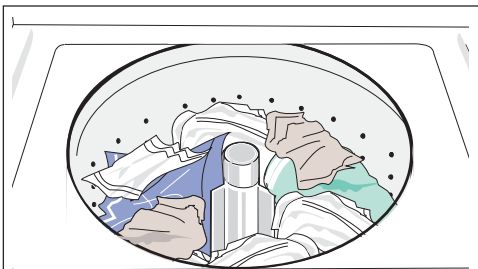

Do not load items above top row of holes in wash tub.

### 6. Add laundry load to washer.

- Dry load level should not be higher than top row of holes in wash tub. **Do not overload washer.**
- Do not put items on top of agitator or wrap them around it. Load items evenly.
- Combine large and small items in a load. Load large items first. Large items should not be more than half the total wash load.
- When washing a single heavy item, add 1 or 2 towels to balance the load.

### 7. If desired, add liquid fabric softener to Fabric Softener Dispenser (some models).

**For models with a built-in dispenser (see picture to the left):**

1. Add liquid softener to the dispenser, following fabric softener label directions.
2. Add water to bring liquid level to fill line on dispenser cap.
3. Remove the dispenser from the agitator after each use. Rinse both cap and cup with warm water. Replace dispenser in the agitator.

**NOTE:** To separate cap from cup, put thumb into dispenser and push against side of cup (see picture to the left). After cleaning, push cap and cup firmly together. Replace dispenser by lining up the ribs and grooves and snapping it into position.

Fabric softener will be flushed from area under the built-in fabric softener dispenser when Large Load Water Level is selected. If a build-up of fabric softener occurs, clean with hot water. **DO NOT REMOVE SERVICE CAP.**

**For models with a removable dispenser (see picture below to the left):**

1. Attach fabric softener dispenser to top of agitator by pressing down gently.
2. Add softener to the dispenser, following fabric softener label directions.
3. Add water to bring liquid level to top of the peg in the center of the cup.
4. Remove the dispenser from the agitator after each use. Rinse both lid and bowl thoroughly with warm water. Reassemble and place dispenser on agitator or store it nearby.

**For models without a fabric softener dispenser,** follow fabric softener label directions. Add diluted fabric softener to the final rinse. **Do not pour fabric softener directly on the wash load.**

### 8. Set cycle selector knob and washer controls according to type, size, and soil level of each load, and detergent used.

See **Operating Instructions** card for your specific model controls.

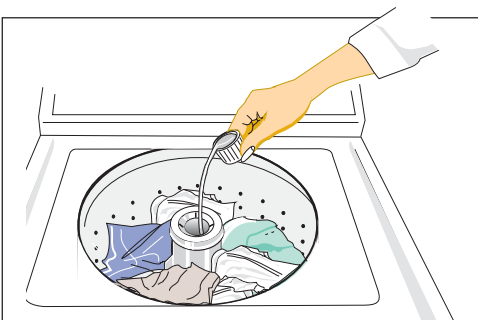

Built-In Fabric Softener Dispenser (some models)

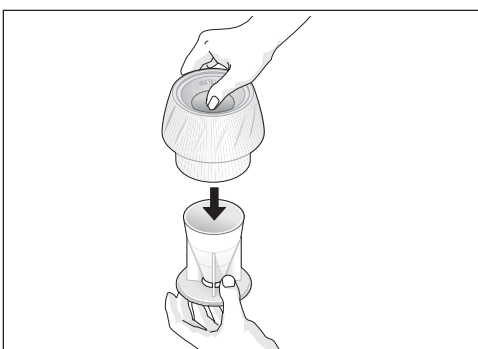

Built-In Fabric Softener Dispenser (some models)

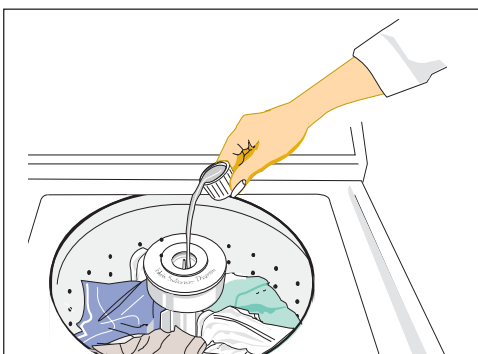

Removable Fabric Softener Dispenser (some models)

## Washing Procedures

(continued)

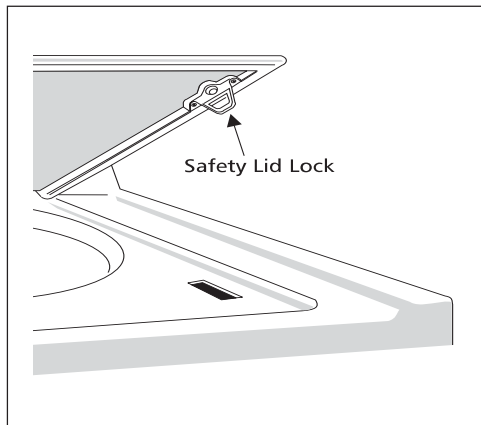

### 9. Start the washer.

Close the washer lid and pull out the cycle selector knob. The washer will not agitate or spin with the lid open.

- To stop the washer, push in the cycle selector knob.
- Do not stop and restart washer during a spin when using the fabric softener dispenser.
- To change a cycle, push in the cycle selector knob. Turn it clockwise to the desired setting. Pull out the knob to restart the washer.

### 10. Remove items when the cycle is completed.

For your safety, the lid locks when the tub is spinning. It will remain locked for about 1 minute after the tub stops spinning.

- To open the lid during a spin, push in the cycle selector knob and wait about 1 minute for the lid lock to release. Do not force open the locked lid.

Place washed items in automatic dryer, line dry, or dry flat as directed by fabric care label. Excess wrinkling, color transfer or odors may develop in items left in the washer after the cycle has ended.

**⚠ WARNING** To avoid serious personal injury, do not operate washer if safety lid lock is missing or damaged.

## Stain Removal



### Safe Stain Removal Procedures

**⚠ WARNING** To reduce the risk of fire or serious injury to persons or property, comply with the basic warnings listed below:

- Read and comply with all instructions on stain removal products.
- Keep products in their original labeled containers and out of children's reach.
- Thoroughly wash any utensil used.
- Do not combine stain removal products, especially ammonia and chlorine bleach. Dangerous fumes may result.
- Never wash items which have been previously cleaned in, washed in, soaked in or spotted with gasoline, dry cleaning solvents or other flammable or explosive substances because they give off vapors that could ignite or explode.
- Never use highly flammable solvents, such as gasoline, inside the home. Vapors can explode on contact with flames or sparks.

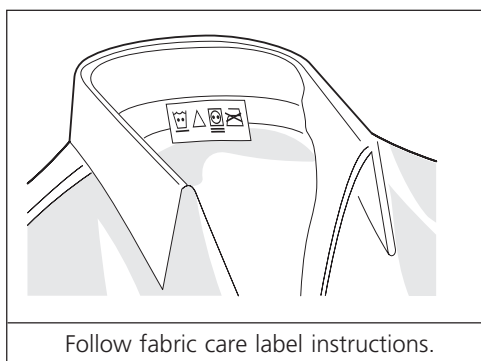

### For successful stain removal:

- Remove stains promptly.
- Determine the kind of stain, then follow recommended treatment in the stain removal chart on the next page.
- To pretreat stains, use a prewash product, liquid detergent, or a paste made from granular detergent and water.
- Use cold water on unknown stains because hot water can set stains.
- Check care label instructions for treatments to avoid on specific fabrics.
- Check for colorfastness by testing stain remover on an inside seam.
- Rinse and wash items after stain removal.

## ***Stain Removal***

<b><i>STAIN</i></b>	<b><i>TREATMENT</i></b>
Adhesive tape, chewing gum, rubber cement	Apply ice. Scrape off excess. Place stain face down on paper towels. Saturate with prewash stain remover or nonflammable dry cleaning fluid.
Baby formula, dairy products, egg	Use product containing enzymes to pretreat or soak stains. Soak for 30 minutes or more. Wash.
Beverages (coffee, tea, soda, juice, alcoholic beverages)	Pretreat stain. Wash using cold water and bleach safe for fabric.
Blood	Rinse with cold water. Rub with bar soap. Or, pretreat or soak with product containing enzymes. Wash using bleach safe for fabric.
Candle wax, crayon	Scrape off surface wax. Place stain face down between paper towels. Press with warm iron until wax is absorbed. Replace paper towels frequently. Treat remaining stain with prewash stain remover or nonflammable dry cleaning fluid. Hand wash to remove solvent. Wash using bleach safe for fabric.
Chocolate	Pretreat or soak in warm water using product containing enzymes. Wash using bleach safe for fabric.
Collar or cuff soil, cosmetics	Pretreat with prewash stain remover or rub with bar soap.
Dye transfer on white fabric	Use packaged color remover. Wash using bleach safe for fabric.
Grass	Pretreat or soak in warm water using product containing enzymes. Wash using bleach safe for fabric.
Grease, oil, tar (butter, fats, salad dressing, cooking oils, car grease, motor oils)	Scrape residue from fabric. Pretreat. Wash using hottest water safe for fabric. For heavy stains and tar, apply nonflammable dry cleaning fluid to back of stain. Replace towels under stain frequently. Rinse thoroughly. Wash using hottest water safe for fabric.
Ink	Some inks may be impossible to remove. Washing may set some inks. Use prewash stain remover, denatured alcohol or nonflammable dry cleaning fluid.
Mildew, scorch	Wash with chlorine bleach if safe for fabric. Or, soak in oxygen bleach and hot water before washing. Badly mildewed fabrics may be permanently damaged.
Mud	Brush off dry mud. Pretreat or soak with product containing enzymes.
Mustard, tomato	Pretreat with prewash stain remover. Wash using bleach safe for fabric.
Nail polish	May be impossible to remove. Place stain face down on paper towels. Apply nail polish remover to back of stain. Repeat, replacing paper towels frequently. Do not use on acetate fabrics.
Paint, varnish	WATER BASED: Rinse fabric in cool water while stain is wet. Wash. Once paint is dry, it cannot be removed. OIL BASED AND VARNISH: Use solvent recommended on can label. Rinse thoroughly before washing.
Perspiration	Use prewash stain remover or rub with bar soap. Rinse. Wash using nonchlorine bleach in hottest water safe for fabric.
Rust, brown or yellow discoloration	For spots, use rust remover safe for fabric. For discoloration of an entire load, use nonchlorine bleach. <b><i>Do not use chlorine bleach because it may intensify discoloration.</i></b>
Shoe polish	LIQUID: Pretreat with a paste of granular detergent and water. PASTE: Scrape residue from fabric. Pretreat with prewash stain remover or nonflammable dry cleaning fluid. Rinse. Rub detergent into dampened area. Wash using bleach safe for fabric.
Urine, vomit, mucus, feces	Pretreat or soak in product containing enzymes. Wash using bleach safe for fabric.

## Common Washing Problems

Many washing problems involve poor soil and stain removal, residues of lint and scum, and fabric damage. For satisfactory washing results, follow these suggestions provided by The Soap and Detergent Association.

<b>PROBLEM</b>	<b>POSSIBLE CAUSES</b>	<b>SOLUTIONS</b>	<b>PREVENTIVE MEASURES</b>
<b>Blue stains</b>	<ul style="list-style-type: none"> <li>•Detergent or liquid fabric softener did not dissolve or disperse.</li> </ul>	<ul style="list-style-type: none"> <li>•If caused by detergent, mix 1 cup (240 ml) white vinegar with 1 quart (.95 L) water in a plastic container. Soak item 1 hour. Rinse.</li> <li>•If caused by fabric softener, rub stains with bar soap. Wash.</li> </ul>	<ul style="list-style-type: none"> <li>•Add detergent before wash load. Then start washer.</li> <li>•Dilute fabric softener with water.</li> </ul>
<b>Discoloration, graying</b>	<ul style="list-style-type: none"> <li>•Not enough detergent.</li> <li>•Wash water temperature too low.</li> <li>•Incorrect sorting.</li> </ul>	<ul style="list-style-type: none"> <li>•Rewash with correct amount of detergent and hottest water safe for fabric. Add bleach safe for fabric.</li> </ul>	<ul style="list-style-type: none"> <li>•Sort items by soil level and color.</li> <li>•Use correct amount of detergent, hottest water and bleach safe for fabric.</li> </ul>
<b>Greasy, oily stains</b>	<ul style="list-style-type: none"> <li>•Not enough detergent.</li> <li>•Undiluted liquid fabric softener poured directly on fabric.</li> </ul>	<ul style="list-style-type: none"> <li>•Treat with prewash stain remover or liquid detergent.</li> <li>•Increase detergent and water temperature. Rewash.</li> <li>•Rub fabric softener stains with bar soap.</li> </ul>	<ul style="list-style-type: none"> <li>•Use correct amount of detergent and hottest water safe for fabric.</li> <li>•<b>Do not pour liquid fabric softener directly on fabric.</b> See package directions or <b>Washing Procedures</b> for proper diluting.</li> </ul>
<b>Holes, tears, or snags</b>	<ul style="list-style-type: none"> <li>•Incorrect use of chlorine bleach.</li> <li>•Unfastened zippers, hooks, buckles.</li> <li>•Rips, tears and broken threads.</li> <li>•Overloading the washer.</li> <li>•Degradation of fabric.</li> </ul>	<ul style="list-style-type: none"> <li>•May be irreversible if rips, tears and seams cannot be mended.</li> </ul>	<ul style="list-style-type: none"> <li>•Never pour chlorine bleach directly on fabric.</li> <li>•Check condition of items before washing. See <b>Washing Procedures</b> for preparing and loading the wash load.</li> </ul>
<b>Lint</b>	<ul style="list-style-type: none"> <li>•Incorrect sorting.</li> <li>•Tissues left in pocket.</li> <li>•Overloading the washer.</li> <li>•Not enough detergent.</li> <li>•Undissolved detergent has left residue.</li> <li>•Static cling is attracting lint.</li> <li>•Load washed too long.</li> </ul>	<ul style="list-style-type: none"> <li>•Reduce load size. Rewash using correct water temperature, water level, and amount of detergent.</li> <li>•Add nonprecipitating water conditioner to wash water.</li> <li>•Add liquid fabric softener to final rinse.</li> <li>•Dry load in dryer.</li> <li>•Remove lint with lint brush or roller.</li> </ul>	<ul style="list-style-type: none"> <li>•See <b>Washing Procedures</b> for sorting and preparing the wash load.</li> <li>•Do not overload washer.</li> <li>•Use correct amount of detergent, water temperature and water level.</li> </ul>
<b>Pilling</b> (Fibers break off, ball up and cling to fabric)	<ul style="list-style-type: none"> <li>•Pilling is normal with synthetic and permanent press fabrics. This is due to abrasion from normal wear.</li> </ul>	<ul style="list-style-type: none"> <li>•Use a lint brush or shaver to remove pills.</li> </ul>	<ul style="list-style-type: none"> <li>•Use fabric softener in the washer to lubricate fibers.</li> <li>•When ironing, use spray starch or fabric finish on collars and cuffs.</li> <li>•Turn items inside out to reduce abrasion.</li> </ul>
<b>Residue or powder on dark items; Stiff, harsh fabrics.</b>	<ul style="list-style-type: none"> <li>•Undissolved detergent.</li> <li>•Some nonphosphate granular detergents can combine with hard water minerals to form a residue.</li> </ul>	<ul style="list-style-type: none"> <li>•Reduce load size.</li> <li>•Add dissolved detergent to tub. Rewash load.</li> <li>•Mix 1 cup (240 ml) white vinegar to 1 gallon (3.8 L) warm water in plastic container. Soak item. Rinse and rewash.</li> </ul>	<ul style="list-style-type: none"> <li>•Increase water temperature using hottest water safe for fabric.</li> <li>•Do not overload washer.</li> <li>•Use liquid detergent or use nonprecipitating water conditioner with nonphosphate granular detergent.</li> </ul>
<b>Wrinkling</b>	<ul style="list-style-type: none"> <li>•Overloading the washer.</li> </ul>	<ul style="list-style-type: none"> <li>•Reduce load size.</li> <li>•Rinse in cold water with liquid fabric softener.</li> </ul>	<ul style="list-style-type: none"> <li>•Do not overload washer.</li> <li>•Remove items from washer as soon as cycle is completed.</li> <li>•Use liquid fabric softener.</li> </ul>
<b>Yellow buildup of body soil on synthetic fabrics</b>	<ul style="list-style-type: none"> <li>•Agitation time too short.</li> <li>•Wash water temperature too low.</li> <li>•Not enough detergent.</li> </ul>	<ul style="list-style-type: none"> <li>•Soak in detergent booster or product containing enzymes.</li> <li>•Wash in hot water (120°F/49°C) using full permanent press cycle. Increase detergent. Add bleach safe for fabric.</li> <li>•Or, treat with color remover.</li> </ul>	<ul style="list-style-type: none"> <li>•Wash synthetics frequently using water at least 100°F (37°C) and correct water level.</li> </ul>
<b>Yellow or brown rust stains</b>	<ul style="list-style-type: none"> <li>•Iron or manganese in water supply, water pipes, or water heater.</li> </ul>	<ul style="list-style-type: none"> <li>•To restore discolored load of whites, use rust remover safe for fabric.</li> <li>•<b>Do not use chlorine bleach to remove rust stains. It may intensify discoloration.</b></li> </ul>	<ul style="list-style-type: none"> <li>•Use nonprecipitating water softener.</li> <li>•Before washing, run hot water for a few minutes to clear lines.</li> <li>•Drain water heater occasionally.</li> <li>•For an ongoing problem, install an iron filter in your water supply system.</li> </ul>

## Care and Cleaning

**CAUTION** Use care with laundry products. They can damage finish on the washer.



### Inside

- Remove items from the washer as soon as the cycle ends. Excess wrinkling, color transfer, and odors may develop in items left in the washer.
- Dry the washer top, the area around the lid opening, and the underside of the lid. These areas should always be dry before the lid is closed.
- Before cleaning the washer interior, **unplug the electrical power cord** to avoid electrical shock hazards.
- When extremely soiled items have been washed, a dirty residue may remain on the tub. Remove this by wiping the tub with a nonabrasive household cleanser. Rinse thoroughly with water.
- The agitator or tub may become stained from fabric dye. Clean these parts with a nonabrasive household cleanser. This prevents dye transfer to future loads.

### Outside

- When washing is completed, wipe top and sides of washer with a damp cloth. Turn water faucets off to prevent pressure build-up in the hoses.
- As needed, clean the cabinet with mild soap and water. **Never use harsh, gritty or abrasive cleansers.** If top or lid becomes stained, clean with diluted chlorine bleach [1/2 cup (120 ml) in 1 quart (.95 L) water]. Rinse several times with clear water.
- Remove glue residue from tape or labels with a mixture of warm water and mild detergent. Or, touch residue with the sticky side of the tape or label.
- **Before moving the washer,** place a strip of cardboard or thin fiberboard under the front leveling legs to prevent floor damage.

### Winterizing Instructions

If the washer is stored in an area where freezing can occur or moved in freezing temperatures, follow these winterizing instructions to prevent damage to the washer:

1. Turn off water supply faucets.
2. Disconnect hoses from water supply and drain water from hoses.
3. Plug electrical cord into a properly grounded electrical outlet.
4. Add 1 gallon nontoxic recreational vehicle (RV) antifreeze to empty wash tub. Close lid.
5. Set cycle selector knob at a spin setting. Pull out knob and let washer spin for 1 minute to drain out all water. Not all of the RV antifreeze will be expelled.
6. Push in knob, unplug electrical power cord, dry tub interior, and close lid.
7. Store washer in an upright position.
8. To remove antifreeze from washer after storage, run empty washer through a complete cycle using detergent. **Do not add wash load.**

**Follow Winterizing Instructions for cold weather care.**

## Avoid Service Checklist

Before calling for service, review this list. It may save both time and expense. The list includes common concerns that are not the result of defective workmanship or materials in this washer.

### OCCURRENCE

### POSSIBLE CAUSE

### SOLUTION

#### NOISE

<b>"Clunking" or gear sounds.</b>	A certain amount of "clunking" or gear sounds are normal in a heavy-duty washer.	This is normal.
<b>Rattling and clanking noise.</b>	Foreign objects such as coins or safety pins may be in tub or pump.	Stop washer and check tub. If noise continues after washer is restarted, objects may be in pump. Call your authorized servicer.
	Belt buckles and metal fasteners are hitting wash tub.	To prevent unnecessary noise and damage to tub, fasten fasteners and turn items inside out.
<b>Squealing sound or hot rubber odor.</b>	Washer is overloaded.	Do not overload washer. Stop washer and reduce load.
<b>Thumping sound.</b>	Heavy wash loads may produce a thumping sound.	This is usually normal. If sound continues, washer is probably out of balance. Stop washer and redistribute wash load.
<b>Vibrating noise.</b>	Washer is not resting firmly on floor.	Move washer so it rests firmly on floor. Adjust leveling legs. See INSTALLATION INSTRUCTIONS for details.
	Shipping bolt and block have not been removed during installation.	See INSTALLATION INSTRUCTIONS for removing shipping bolt and block.
	Wash load unevenly distributed in tub.	Stop washer and rearrange wash load.
<b>OPERATING</b> <b>Washer does not start.</b>	Electrical power cord may not be plugged in or connection may be loose.	Make sure plug fits tightly in wall outlet.
	House fuse blown, circuit breaker tripped, or a power outage has occurred.	Reset circuit breaker or replace fuse. Do not increase fuse capacity. If problem is a circuit overload, have it corrected by a qualified electrician. If problem is a power outage, call local electric company.
	Water supply faucets are not turned on.	Turn on water supply faucets.
	Cycle selector is not in correct position.	Move indicator clockwise slightly. Pull out knob.
	Motor is overheated.	Washer motor will stop if it becomes overheated. It will automatically restart after a cool down period of up to 30 minutes (if washer has not been manually turned off).
	Lid is not completely closed.	Close lid completely.
<b>Washer won't spin.</b>	Heavily soiled items.	Wipe tub with a nonabrasive household cleanser, then rinse. Shake or brush excess dirt and sand from items before washing.

<b>OCCURRENCE</b>	<b>POSSIBLE CAUSE</b>	<b>SOLUTION</b>
<b>Water</b>	Washer is overloaded.	Do not overload washer. See <b>Washing Procedures.</b>
	Load is out of balance.	Rearrange load to allow proper spinning.
	Drain hose is kinked.	Straighten drain hose.
<b>Water does not enter washer or it enters slowly.</b>	Water supply is not adequate in area.	Check another faucet in the house. Wait until water supply and pressure increase.
	Water supply faucets are not completely open.	Fully open hot and cold faucets.
	Water is being used elsewhere in the house.	Water pressure must be at least 30 psi (260 kPa). Avoid running water elsewhere while washer is filling.
	Water inlet hoses are kinked.	Straighten hoses.
<b>Water level does not cover load.</b>	Improper water level selection (for models with water level/load size control).	Select higher water level/load size.
	Washer is overloaded.	Do not overload washer. When control is set at highest fill level, dry load level should not be higher than top row of circular holes in wash tub.
<b>Warm or hot water is not hot enough.</b>	Hot water heater is set too low or is a distance from washer.	Measure hot water temperature at nearby faucet with candy or meat thermometer. Water temperature should be at least 130°F (70°C). Adjust water heater as necessary.
	Hot water is being used elsewhere in the house.	Avoid using hot water elsewhere before or during washer use. There may not be enough hot water available for proper cleaning. If problem persists, your hot water system may be unable to support more than 1 use at a time.
<b>Water in washer does not drain or drains slowly.</b>	Drain hose is kinked or clogged.	Clean and straighten the drain hose.
<b>Water leaks.</b>	Fill hose connection at faucet or washer.	Check and tighten hose connections. Install rubber sealing washers provided.
	House drain pipes are clogged.	Unclog drain pipes. Contact plumber if necessary.
	Oversudsing.	Use less detergent.
<b>Incorrect wash and rinse temperatures.</b>	Hot and cold water hoses are connected to wrong supply faucets.	Connect hot water hose to hot water faucet and cold water hose to cold water faucet.
<b>Water is entering washer but tub does not fill.</b>	Drain hose standpipe is incorrect height.	Standpipe must be a minimum of 33" (83.82 cm) high to prevent siphoning. See INSTALLATION INSTRUCTIONS.