

This Owner's Manual is provided and hosted by [Appliance Factory Parts](#).



KITCHENAID 5K5SSWH2 Owner's Manual

[Shop genuine replacement parts for KITCHENAID
5K5SSWH2](#)

KitchenAid®

[Find Your KITCHENAID Mixer Parts - Select From 532 Models](#)

----- Manual continues below -----

KitchenAid®

STAND MIXER INSTRUCTIONS AND RECIPES



9706634D

FOR THE WAY IT'S MADE.®



1-800-541-6390
Details Inside

Hassle-Free Replacement Warranty



We're so confident the quality of our products meets the exacting standards of KitchenAid that, if your stand mixer should fail within the first year of ownership, KitchenAid will arrange to deliver an identical or comparable replacement to your door free of charge and arrange to have your "failed" stand mixer returned to us. Your replacement stand mixer will also be covered by our one year full warranty. Please follow these instructions to receive this high-quality service.

If you reside in the United States and your KitchenAid® stand mixer should fail within the first year of ownership, simply call our toll-free Customer Satisfaction Center at **1-800-541-6390**, 8 a.m. to 8 p.m., Monday through Friday, 10 a.m. to 5 p.m., Saturday, Eastern Time. Give the consultant your complete shipping address. (No P.O. Box Numbers, please.)

When you receive your replacement stand mixer, use the carton and packing materials to pack-up your "failed" stand mixer. In the carton, include your name and address on a sheet of paper along with a copy of the proof of purchase (register receipt, credit card charge slip, etc.).

For a detailed explanation of warranty terms and conditions, including how to arrange for service outside the United States, see the Warranty section.

Proof of Purchase and Product Registration

Always keep a copy of the sales receipt showing the date of purchase of your stand mixer. Proof of your purchase will assure you of in-warranty service.

Before you use your stand mixer, please fill out and mail your product registration card packed with the stand mixer. This card will

enable us to contact you in the unlikely event of a product safety notification and assist us in complying with the provisions of the Consumer Product Safety Act. This card does not verify your warranty.

Please complete the following for your personal records:

Model Number _____

Serial Number _____

Date Purchased _____

Store Name _____

Table of Contents

INTRODUCTION

Hassle-Free Replacement Warranty	Inside Front Cover
Product Registration Card	Inside Front Cover
Stand Mixer Safety	4
Important Safeguards.....	4
Warranty.....	5
For the United States and District of Columbia	5
For Puerto Rico.....	6
Arranging for Service after the Warranty Expires.....	6
Arranging for Service Outside the United States and Puerto Rico	6
Ordering Accessories and Replacement Parts	6
Electrical Requirements.....	7
Troubleshooting Problems.....	7

ABOUT YOUR MIXER

Bowl-Lift Models.....	8
Assembling Your Bowl-Lift Mixer.....	9
Tilt-Head Models.....	10
Assembling Your Tilt-Head Mixer	11
Using Your KitchenAid® Attachments	12
Mixing Time	12
Mixer Use.....	12
Care and Cleaning	13
Beater to Bowl Clearance	13
Speed Control Guide	14
Mixing Tips	15
Egg Whites	16
Whipped Cream.....	16
Attachments and Accessories - General Information.....	17

RECIPES

Appetizers, Entrees, and Vegetables	18
Cakes and Frostings.....	26
Cookies, Bars, and Candies.....	35
Pies and Desserts	41
Yeast Breads and Quick Breads	46
General Instructions for Mixing and Kneading Yeast Dough	46
Bread Making Tips.....	47

OPTIONAL ACCESSORIES

KitchenAid® Attachments and Accessories	64
---	----

Stand Mixer Safety

Your safety and the safety of others are very important.

We have provided many important safety messages in this manual and on your appliance. Always read and obey all safety messages.



This is the safety alert symbol.

This symbol alerts you to potential hazards that can kill or hurt you and others.

All safety messages will follow the safety alert symbol and either the word "DANGER" or "WARNING." These words mean:

! DANGER

You can be killed or seriously injured if you don't immediately follow instructions.

! WARNING

You can be killed or seriously injured if you don't follow instructions.

All safety messages will tell you what the potential hazard is, tell you how to reduce the chance of injury, and tell you what can happen if the instructions are not followed.

IMPORTANT SAFEGUARDS

When using electrical appliances, basic safety precautions should always be followed including the following:

1. Read all instructions.
2. To avoid risk of electrical shock, do not put stand mixer in water or other liquid.
3. Close supervision is necessary when this or any appliance is used near children.
4. Unplug stand mixer from outlet when not in use, before putting on or taking off parts and before cleaning.
5. Avoid contacting moving parts. Keep hands, hair, clothing, as well as spatulas and other utensils away from beater during operation to reduce the risk of injury to persons and/or damage to the stand mixer.
6. Do not operate stand mixer with a damaged cord or plug or after the stand mixer malfunctions, or is dropped or damaged in any manner. Call the KitchenAid Customer Satisfaction Center at 1-800-541-6390 for more information.
7. The use of attachments not recommended or sold by KitchenAid may cause fire, electrical shock or injury.
8. Do not use the stand mixer outdoors.
9. Do not let the cord hang over edge of table or counter.
10. Remove flat beater, wire whip or dough hook from stand mixer before washing.

SAVE THESE INSTRUCTIONS
THIS PRODUCT IS DESIGNED FOR HOUSEHOLD USE ONLY.

KitchenAid® Stand Mixer Warranty for the 50 United States and District of Columbia

This warranty extends to the purchaser and any succeeding owner for stand mixers operated in the 50 United States and District of Columbia.

Length of Warranty:	KitchenAid Will Pay For Your Choice of:	KitchenAid Will Not Pay For:
<p>One Year Full Warranty from date of purchase.</p>	 <p>Hassle-Free Replacement of your stand mixer. See inside front cover for details on how to arrange for service, or call the Customer Satisfaction Center toll-free at 1-800-541-6390. OR The replacement parts and repair labor costs to correct defects in materials and workmanship. Service must be provided by an Authorized KitchenAid Service Center. See the KitchenAid® Stand Mixer Warranty for Puerto Rico on the following page on how to arrange for service.</p>	<p>A. Repairs when stand mixer is used in other than normal single family home use. B. Damage resulting from accident, alteration, misuse or abuse. C. Any shipping or handling costs to deliver your stand mixer to an Authorized Service Center. D. Replacement parts or repair labor costs for stand mixers operated outside the 50 United States and District of Columbia.</p>

KITCHENAID DOES NOT ASSUME ANY RESPONSIBILITY FOR INCIDENTAL OR CONSEQUENTIAL DAMAGES. Some states do not allow the exclusion or limitation of incidental or consequential damages, so this exclusion may not apply to you. This warranty gives you specific legal rights and you may also have other rights which vary from state to state.

KitchenAid® Stand Mixer Warranty for Puerto Rico

A limited one year warranty extends to the purchaser and any succeeding owner for stand mixers operated in Puerto Rico. During the warranty period, all service must be handled by an Authorized KitchenAid Service Center. Please bring the stand mixer, or ship it

prepaid and insured, to the nearest Authorized Service Center. Call toll-free **1-800-541-6390** to learn the location of a Service Center near you. Your repaired stand mixer will be returned to you prepaid and insured.

Arranging for Service After the Warranty Expires

For service information, call toll-free 1-800-541-6390 or write to:

Customer Satisfaction Center,
KitchenAid Portable Appliances, P.O.
Box 218, St. Joseph, MI 49085-0218.

Arranging for Service Outside the United States and Puerto Rico

Consult your local KitchenAid dealer or the store where you purchased

the stand mixer for information on how to obtain service.

Ordering Accessories and Replacement Parts

To order accessories or replacement parts for your stand mixer, call toll-free 1-800-541-6390 or write to:

Customer Satisfaction Center,
KitchenAid Portable Appliances, P.O.
Box 218, St. Joseph, MI 49085-0218.

Electrical Requirements

Volts: 120 A.C. only. Hertz: 60
The wattage rating for your stand mixer is printed on the trim band or on the serial plate.

Do not use an extension cord. If the power supply cord is too short, have a qualified electrician or serviceman install an outlet near the appliance.

The maximum rating is based on the attachment that draws the greatest load (power). Other recommended attachments may draw significantly less power.

⚠ WARNING



Electrical Shock Hazard

Plug into a grounded 3 prong outlet.

Do not remove ground prong.

Do not use an adapter.

Do not use an extension cord.

Failure to follow these instructions can result in death, fire, or electrical shock.

Troubleshooting Problems

Please read the following before calling your service center.

1. The stand mixer may warm up during use. Under heavy loads with extended mixing time periods, you may not be able to comfortably touch the top of the stand mixer. This is normal.
2. The stand mixer may emit a pungent odor, especially when new. This is common with electric motors.
3. If the flat beater hits the bowl, stop the stand mixer. See the "Beater to Bowl Clearance" section.

Keep a copy of the sales receipt showing the date of purchase. Proof of purchase will assure you of in-warranty service.

If your stand mixer should malfunction or fail to operate, please check the following:

- Is the stand mixer plugged in?
- Is the fuse in the circuit to the stand mixer in working order? If you have a circuit breaker box, be sure the circuit is closed.
- Turn the stand mixer off for 10-15 seconds, then turn it back on. If the mixer still does not start, allow it to cool for 30 minutes before turning it back on.
- If the problem is not due to one of the above items, see the "Arranging for Service" section.
- Do not return the stand mixer to the retailer as they do not provide service.

Bowl-Lift Models* Stand Mixer Features

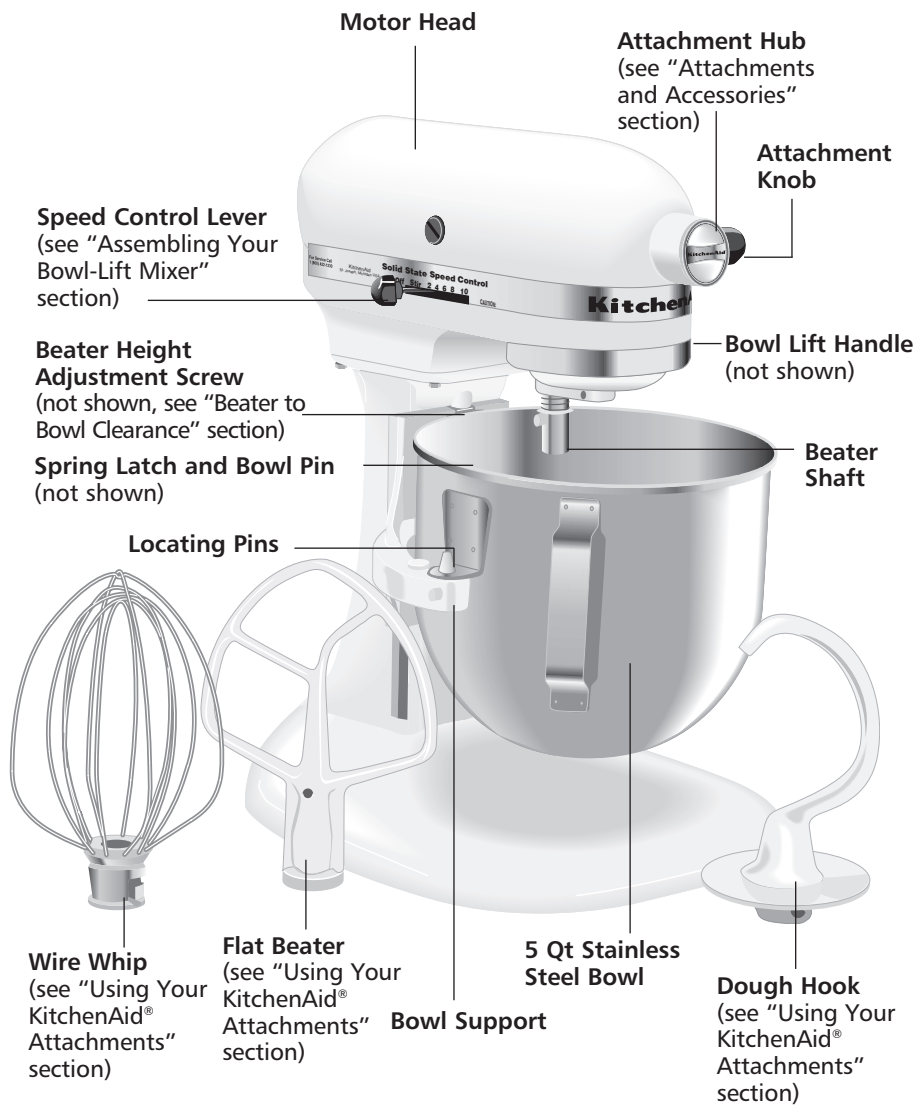

*Bowl-Lift models include K5SS, KSM5, KSM50P, KP50PS

Assembling Your Bowl-Lift Mixer

⚠ WARNING



Electrical Shock Hazard

Plug into a grounded 3 prong outlet.

Do not remove ground prong.

Do not use an adapter.

Do not use an extension cord.

Failure to follow these instructions can result in death, fire, or electrical shock.

To Attach Bowl

1. Be sure speed control is OFF and stand mixer is unplugged.
2. Place bowl lift handle in down position.
3. Fit bowl supports over locating pins.
4. Press down on back of bowl until bowl pin snaps into spring latch.
5. Raise bowl before mixing.
6. Plug into a grounded 3 prong outlet.

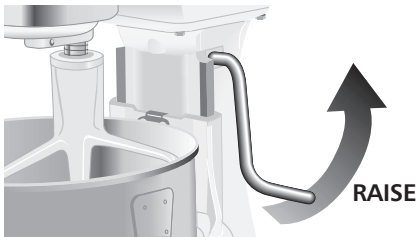

To Raise Bowl

1. Rotate handle to straight-up position.
2. Bowl must always be in raised, locked position when mixing.

To Lower Bowl

1. Rotate handle back and down.

To Remove Bowl

1. Be sure speed control is OFF and stand mixer is unplugged.
2. Place bowl lift handle in down position.
3. Remove flat beater, wire whip, or dough hook.
4. Grasp bowl handle and lift straight up and off locating pins.

To Attach Flat Beater, Wire Whip, or Dough Hook

1. Turn speed control to OFF and unplug.
2. Slip flat beater on beater shaft and press upward as far as possible.
3. Turn beater to right, hooking beater over the pin on shaft.



4. Plug into a grounded 3 prong outlet.

To Remove Flat Beater, Wire Whip, Or Dough Hook

1. Turn speed control to OFF and unplug.
2. Press beater upward as far as possible and turn left.
3. Pull beater from beater shaft.

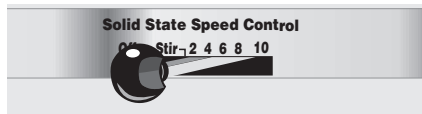

Household stand mixer SPEED Control

Plug into a grounded 3 prong outlet. Speed control lever should always be set on lowest speed for starting, then gradually moved to desired higher speed to avoid splashing ingredients out of bowl. See "Speed Control Guide" section.

Tilt-Head Models* Stand Mixer Features

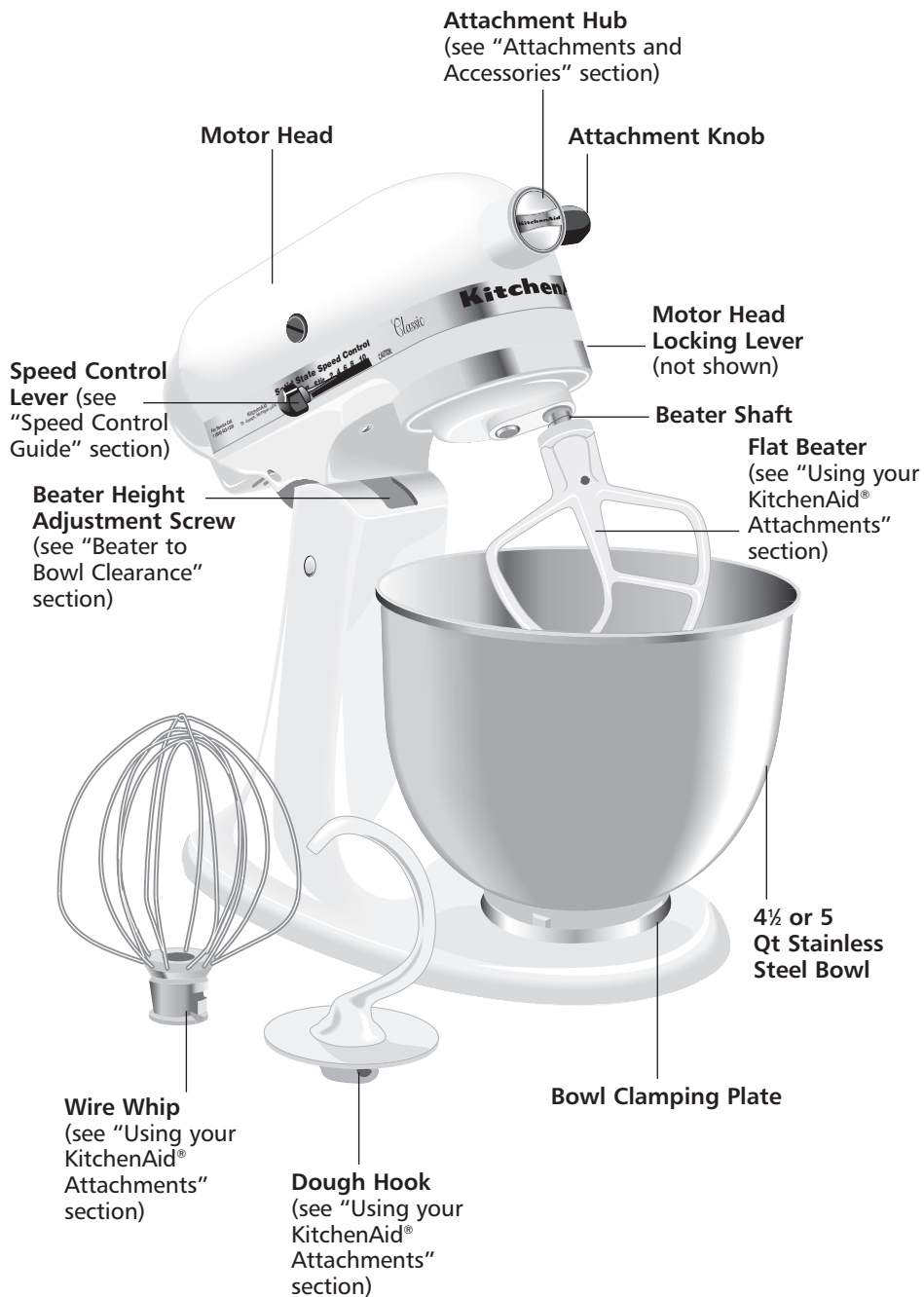

*4½ Qt models include K45, KSM90, KSM103, KSM75

*5 Qt model KSM150, KSM151

Assembling Your Tilt-Head Mixer

⚠ WARNING



Electrical Shock Hazard

Plug into a grounded 3 prong outlet.

Do not remove ground prong.

Do not use an adapter.

Do not use an extension cord.

Failure to follow these instructions can result in death, fire, or electrical shock.



To Attach Bowl

1. Turn speed control to OFF.
2. Unplug stand mixer.
3. Tilt motor head back.
4. Place bowl on bowl clamping plate.
5. Turn bowl gently in clockwise direction.
6. Plug into a grounded 3 prong outlet.

To Remove Bowl

1. Turn speed control to OFF.
2. Unplug stand mixer.
3. Tilt motor head back.
4. Turn bowl in counterclockwise direction.

To Attach Flat Beater, Wire Whip, Or Dough Hook

1. Turn speed control to OFF.
2. Unplug stand mixer.

3. Tilt motor head back.
4. Slip beater onto beater shaft and press upward as far as possible.
5. Turn beater to right, hooking beater over pin of shaft.
6. Plug into a grounded 3 prong outlet.

To Remove Flat Beater, Wire Whip Or Dough Hook

1. Turn speed control to OFF.
2. Unplug stand mixer.
3. Tilt motor head back.
4. Press beater upward as far as possible.
5. Pull beater from beater shaft.

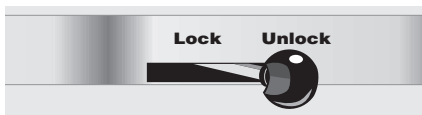

To Lock Motor Head

1. Make sure motor head is completely down.
2. Place locking lever in LOCK position.
3. Before mixing, test lock by attempting to raise head.

To Unlock Motor Head

1. Place lever in UNLOCK position.
- NOTE:** Motor head should always be kept in LOCK position when using stand mixer.

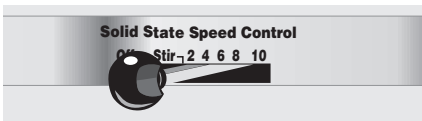

To Operate Speed Control

Plug into a grounded 3 prong outlet. Speed control lever should always be set on lowest speed for starting, then gradually moved to desired higher speed to avoid splashing ingredients out of bowl. See the "Speed Control Guide" section.

Using Your KitchenAid® Attachments

Flat Beater for normal to heavy mixtures:

cakes	biscuits
creamed frostings	quick breads
candies	meat loaf
cookies	mashed potatoes
pie pastry	

Wire Whip for mixtures that need air incorporated:

eggs	sponge cakes
egg whites	angel food cakes
heavy cream	mayonnaise
boiled frostings	some candies

Dough Hook for mixing and kneading yeast doughs:

breads	coffee cakes
rolls	buns

Mixing Time

Your KitchenAid® stand mixer will mix faster and more thoroughly than most other electric mixers. Therefore, the mixing time in most

recipes must be adjusted to avoid overbeating. With cakes, for example, beating time may be half as long as with other mixers.

Mixer Use

WARNING

Injury Hazard

Unplug mixer before touching beaters.

Failure to do so can result in broken bones, cuts or bruises.

NOTE: Do not scrape bowl while stand mixer is operating.

The bowl and beater are designed to provide thorough mixing without frequent scraping. Scraping the bowl once or twice during mixing is usually sufficient. Turn stand mixer off before scraping. The stand mixer may warm up during use. Under heavy loads with extended mixing time, you may not be able to comfortably touch the top of the stand mixer. This is normal.

Care and Cleaning

Bowl, white flat beater and white dough hook may be washed in an automatic dishwasher. Or, clean them thoroughly in hot sudsy water and rinse completely before drying. Wire whip, burnished dough hook and burnished flat beater should be hand washed and dried immediately. Do not wash wire whip, burnished dough hook and burnished flat beater in a dishwasher. Do not store beaters on shaft.

NOTE: Always be sure to unplug stand mixer before cleaning. Wipe stand mixer with a soft, damp cloth. Do not use household/commercial cleaners. Do not immerse in water. Wipe off beater shaft frequently, removing any residue that may accumulate.

Beater to Bowl Clearance

Your stand mixer is adjusted at the factory so that the flat beater just clears the bottom of the bowl. If for any reason, the flat beater hits the bottom of the bowl or is too far away from the bowl, clearance can be corrected as follows:

Tilt-Head models

- Unplug stand mixer.
- Lift motor head.
- Turn screw (A) slightly counterclockwise (left) to raise flat beater or clockwise (right) to lower flat beater.
- Make adjustment with flat beater, so it just clears surface of bowl.

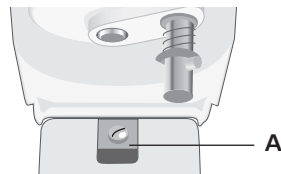

If you overadjust the screw, the bowl lock lever may not lock into place.

Bowl-Lift models

- Unplug stand mixer.
- Place bowl lift handle in down position.
- Turn screw (B) slightly counterclockwise (left) to lower the bowl (increased beater clearance) or clockwise (right) to raise the bowl (reduced beater clearance).
- Make adjustments with flat beater, so it just clears surface of bowl.

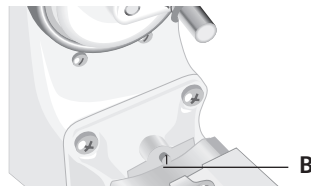

NOTE: When properly adjusted, the flat beater will not strike on bottom or side of bowl. If beater or wire whip is adjusted too close so that it strikes bottom of bowl, coating may wear off beater or wires may wear through on wire whip.

Speed Control Guide

Number of Speed

Stir Speed	STIR	For slow stirring, combining, mashing, starting all mixing procedures. Use to add flour and dry ingredients to batter, add liquids to dry ingredients, and combine heavy mixtures.
2	SLOW MIXING	For slow mixing, mashing, faster stirring. Use to mix heavy batters and candies, start mashing potatoes or other vegetables, cut shortening into flour, mix thin or splashy batters, and mix and knead yeast dough. Use with Can Opener attachment.
4	MIXING, BEATING	For mixing semi-heavy batters, such as cookies. Use to combine sugar and shortening and to add sugar to egg whites for meringues. Medium speed for cake mixes. Use with: Food Grinder, Rotor Slicer/Shredder, and Fruit/Vegetable Strainer.
6	BEATING, CREAMING	For medium fast beating (creaming) or whipping. Use to finish mixing cake, doughnut, and other batters. High speed for cake mixes. Use with Citrus Juicer attachment.
8	FAST BEATING, WHIPPING	For whipping cream, egg whites, and boiled frostings.
10	FAST WHIPPING	For whipping small amounts of cream or egg whites. Use with Pasta Maker and Grain Mill attachments. NOTE: Will not maintain fast speeds under heavy loads, such as when using Pasta Maker or Grain Mill attachments.

NOTE: The Speed Control Lever can be set between the speeds listed in the above chart to obtain speeds 3, 5, 7 and 9 if a finer adjustment is required.

Do not exceed Speed 2 when preparing yeast doughs as this may cause damage to the stand mixer.

Mixing Tips

Converting Your Recipe for the Mixer

The mixing instructions for recipes in this book can guide you in converting your own favorite recipes for preparation with your KitchenAid® stand mixer. Look for recipes similar to yours and then adapt your recipes to use the procedures in the similar KitchenAid recipes.

For example, the “quick mix” method (sometimes referred to as the “dump” method) is ideal for simple cakes, such as the Quick Yellow Cake and Easy White Cake included in this book. This method calls for combining dry ingredients with most or all liquid ingredients in one step.

More elaborate cakes, such as Caramel Walnut Banana Torte, should be prepared using the traditional cake mixing method. With this method, sugar and the shortening, butter or margarine are thoroughly mixed (creamed) before other ingredients are added.

For all cakes, mixing times may change because your KitchenAid® stand mixer works more quickly than other mixers. In general, mixing a cake with the KitchenAid® stand mixer will take about half the time called for in most cake recipes.

To help determine the ideal mixing time, observe the batter or dough and mix only until it has the desired appearance described in your recipe, such as “smooth and creamy.”

To select the best mixing speeds, use the Speed Control Guide.

Adding Ingredients

Always add ingredients as close to side of bowl as possible, not directly into moving beater. The Pouring Shield can be used to simplify adding ingredients.

NOTE: If ingredients in very bottom of bowl are not thoroughly mixed, then the beater is not far enough into the bowl. See “Beater to Bowl Clearance” section.

Cake Mixes

When preparing packaged cake mixes, use Speed 2 for low speed, Speed 4 for medium speed, and Speed 6 for high speed. For best results, mix for the time stated on the package directions.

Adding Nuts, Raisins or Candied Fruits

Follow individual recipes for guidelines on including these ingredients. In general, solid materials should be folded in the last few seconds of mixing on Stir Speed. The batter should be thick enough to keep the fruit or nuts from sinking to the bottom of the pan during baking. Sticky fruits should be dusted with flour for better distribution in the batter.

Liquid Mixtures

Mixtures containing large amounts of liquid ingredients should be mixed at lower speeds to avoid splashing. Increase speed only after mixture has thickened.

Egg Whites

Place room temperature egg whites in clean, dry bowl. Attach bowl and wire whip. To avoid splashing, gradually turn to designated speed and whip to desired stage. See chart below.

AMOUNT	SPEED
1 egg white	GRADUALLY to 10
2-4 egg whites	GRADUALLY to 8
6 or more egg whites	GRADUALLY to 8

Whipping Stages

With your KitchenAid® stand mixer, egg whites whip quickly. So, watch closely to avoid overwhipping. This list tells you what to expect.

Frothy

Large, uneven air bubbles.

Begins to Hold Shape

Air bubbles are fine and compact; product is white.

Soft Peak

Tips of peaks fall over when wire whip is removed.

Almost Stiff

Sharp peaks form when wire whip is removed, but whites are actually soft.

Stiff but not Dry

Sharp, stiff peaks form when wire whip is removed. Whites are uniform in color and glisten.

Stiff and Dry

Sharp, stiff peaks form when wire whip is removed. Whites are speckled and dull in appearance.

Whipped Cream

Pour cold whipping cream into chilled bowl. Attach bowl and wire whip. To avoid splashing, gradually turn to designated speed and whip to desired stage. See chart below.

AMOUNT	SPEED
¼ cup	GRADUALLY to 10
½ cup	GRADUALLY to 10
1 cup	GRADUALLY to 8
1 pint	GRADUALLY to 8

Whipping Stages

Watch cream closely during whipping. Because your KitchenAid® mixer whips so quickly, there are just a few seconds between whipping stages. Look for these characteristics:

Begins to Thicken

Cream is thick and custard-like.

Holds Its Shape

Cream forms soft peaks when wire whip is removed. Can be folded into other ingredients when making desserts and sauces.

Stiff

Cream stands in stiff, sharp peaks when wire whip is removed. Use for topping on cakes or desserts, or filling for cream puffs.

Attachments and Accessories

General Information

KitchenAid® attachments are designed to assure long life. The attachment power shaft and hub socket are of a square design, to eliminate any possibility of slipping during the transmission of power to the attachment. The hub and shaft housing are tapered to assure a snug fit, even after prolonged use and wear. KitchenAid® attachments require no extra power unit to operate them; the power unit is built in. See the Use and Care Guide that came with your stand mixer attachments for speed settings and operating time.

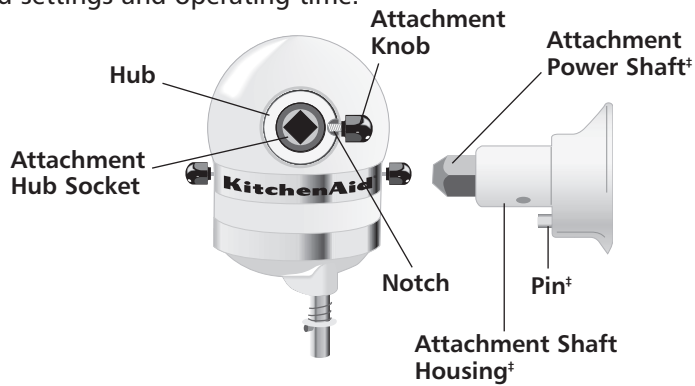

*Not part of mixer.

General Instructions

To Attach

1. Turn stand mixer off and unplug.
2. Loosen attachment knob by turning it counterclockwise.
3. Remove attachment hub cover.
4. Insert attachment shaft housing into attachment hub, making certain that attachment power shaft fits into square attachment hub socket. It may be necessary to rotate attachment back and forth. When attachment is in proper position, the pin on the attachment will fit into the notch on the hub rim.
5. Tighten attachment knob by turning clockwise until attachment is completely secured to stand mixer.

⚠ WARNING



Electrical Shock Hazard

Plug into a grounded 3 prong outlet.

Do not remove ground prong.

Do not use an adapter.

Do not use an extension cord.

Failure to follow these instructions can result in death, fire, or electrical shock.

6. Plug into a grounded 3 prong outlet.

To Remove

1. Turn stand mixer off and unplug.
2. Loosen attachment knob by turning it counterclockwise. Rotate attachment slightly back and forth while pulling out.
3. Replace attachment hub cover. Tighten attachment knob by turning it clockwise.

Crabmeat Dip

- | | |
|---|--|
| <ul style="list-style-type: none"> 1 package (8 oz) light cream cheese 1 cup reduced-fat cottage cheese ¼ cup reduced-calorie mayonnaise 1 can (6½ oz) crabmeat, flaked 1 tablespoon lemon juice 3 tablespoons chopped green onions ½ teaspoon garlic salt 3 drops hot pepper sauce | <p>Place cream cheese, cottage cheese, and mayonnaise in mixer bowl. Attach bowl and flat beater to mixer. Turn to Speed 6 and beat about 1 minute, or until well blended. Stop and scrape bowl. Add all remaining ingredients. Turn to Speed 6 and beat about 1 minute, or until all ingredients are combined.</p> <p>Refrigerate until well chilled. Serve with assorted crackers or raw vegetables.</p> <p>Yield: 24 servings (2 tablespoons per serving).</p> <p>Per serving: About 42 cal, 4 g protein, 1 g carb, 3 g fat, 12 mg chol, 180 mg sodium.</p> |
|---|--|

Creamy Pineapple Fruit Dip

- | | |
|--|---|
| <ul style="list-style-type: none"> 4 oz light cream cheese ½ cup marshmallow cream 1 can (8 oz) crushed pineapple, well drained 2 teaspoons grated orange peel | <p>Place cream cheese in mixer bowl. Attach bowl and flat beater to mixer. Turn to Speed 2 and mix about 30 seconds. Stop and scrape bowl. Add marshmallow cream, pineapple, and orange peel. Turn to Speed 4 and beat about 30 seconds. Stop and scrape bowl. Turn to Speed 4 and beat about 30 seconds. Refrigerate at least 2 hours. Serve with sliced fresh fruit, if desired.</p> <p>Yield: 12 servings (2 tablespoons per serving).</p> <p>Per serving: About 61 cal, 1 g protein, 11 g carb, 2 g fat, 3 mg chol, 58 mg sodium.</p> |
|--|---|

Layered Mexican Dip

<i>1 package (8 oz) light cream cheese</i>	Place cream cheese in mixer bowl. Attach bowl and flat beater to mixer. Turn to Speed 2 and mix about 30 seconds. Stop and scrape bowl. Add Monterey Jack cheese. Turn to Speed 2 and mix about 30 seconds.
<i>½ cup shredded hot pepper Monterey Jack cheese</i>	
<i>¼ cup bean or black bean dip</i>	Spread cheese mixture on 10" serving plate to within 1 or 2" of edge. Spread bean dip over cheese. Spread salsa over bean dip. Top with onions and olives. Refrigerate until ready to serve. Serve with tortilla chips, if desired.
<i>½ cup thick and chunky salsa</i>	
<i>½ cup chopped green onions</i>	Yield: 12 servings (¼ cup per serving). Per serving: About 70 cal, 4 g protein, 3 g carb, 5 g fat, 12 mg chol, 265 mg sodium.
<i>¼ cup sliced pitted ripe olives</i>	

Nutty Cheese Ball

<i>1 cup shredded sharp Cheddar cheese</i>	Place all ingredients, except pecans, in mixer bowl. Attach bowl and flat beater to mixer. Turn to Speed 4 and beat about 1 minute, or until well blended.
<i>1 cup shredded Swiss cheese</i>	
<i>1 package (8 oz) light cream cheese</i>	On waxed paper, shape mixture into a ball. Roll ball in chopped pecans. Wrap in waxed paper. Refrigerate until serving time. Serve with assorted crackers or raw vegetables.
<i>2 tablespoons chopped fresh chives</i>	
<i>2 teaspoons Worcestershire sauce</i>	Yield: 24 servings (2 tablespoons per serving). Per serving: About 65 cal, 4 g protein, 1 g carb, 5 g fat, 13 mg chol, 109 mg sodium.
<i>¼ teaspoon paprika</i>	
<i>½ teaspoon garlic powder</i>	
<i>¼ cup finely chopped pecans</i>	

Spinach and Cheese Crostini

- 1 *baguette loaf, cut into 1/2" slices*
- 2 *teaspoons butter or margarine*
- 1/2 *cup finely chopped onion*
- 1 *clove garlic, minced*
- 1 *package (9 oz) frozen chopped spinach, thawed and squeezed dry*
- 1 *package (8 oz) light cream cheese*
- 1/4 *cup roasted red peppers*
- 1/2 *cup shredded Cheddar cheese*

Place baguette slices on baking sheet. Bake at 375°F for 4 to 6 minutes, or until toasted. Set aside.

Melt butter in 10" skillet over medium heat. Add onion and garlic. Cook and stir 2 to 3 minutes, or until softened. Add spinach. Cook and stir 30 to 60 seconds, or until warm. Cool slightly.

Place cream cheese in mixer bowl. Attach bowl and flat beater to mixer. Turn to Speed 2, mix about 30 seconds. Add spinach mixture. Continuing on Speed 2, mix about 30 seconds. Add red peppers. Continuing on Speed 2, mix about 30 seconds. Spread spinach mixture on toasted baguette slices. Top each slice with about 1 teaspoon Cheddar cheese. Bake at 375°F for 5 to 8 minutes, or until thoroughly heated and cheese is melted. Serve warm.

Yield: 12 servings (2 crostini per serving).

Per serving: About 141 cal, 6 g protein, 16 g carb, 6 g fat, 12 mg chol, 324 mg sodium.

Meatballs with Salsa

- 1/4 *cup fat-free egg substitute or 1 egg*
- 1/3 *cup fresh bread crumbs*
- 1/2 *teaspoon chili powder*
- 1/4 *teaspoon garlic powder*
- 1/8 *teaspoon cayenne pepper*
- 1 *pound ground turkey*
- 1/2 *cup thick and chunky salsa*
- 1/2 *cup chili sauce*
- 1/2 *cup water*

Place egg substitute, bread crumbs, chili powder, garlic powder, pepper, and ground turkey in mixer bowl. Attach bowl and flat beater to mixer. Turn to Stir Speed and mix about 30 seconds.

Form turkey mixture into 1" balls. Spray 12" skillet with no-stick cooking spray. Cook meatballs over medium-high heat until well browned; drain.

Mix salsa, chili sauce, and water in small bowl. Add to meatballs and stir. Reduce heat to low. Cook, covered, about 10 minutes, or until meatballs are thoroughly cooked, stirring frequently. Serve warm.

Yield: 12 servings (3 meatballs per serving).

Per serving: About 84 cal, 8 g protein, 5 g carb, 3 g fat, 30 mg chol, 280 mg sodium.

Mushroom-Onion Tartlets

Pastry Crusts

- 4 oz light cream cheese
- 3 tablespoons butter or margarine, divided
- $\frac{3}{4}$ cup plus 1 teaspoon all-purpose flour
- 8 oz fresh mushrooms, coarsely chopped
- $\frac{1}{2}$ cup chopped green onions

Filling

- 1 egg
- $\frac{1}{4}$ teaspoon dried thyme leaves
- $\frac{1}{2}$ cup shredded Swiss cheese

To make Pastry Crusts:

Place cream cheese and 2 tablespoons butter in mixer bowl. Attach bowl and flat beater to mixer. Turn to Speed 4 and beat about 1 minute. Stop and scrape bowl. Add $\frac{3}{4}$ cup flour. Turn to Speed 2 and mix about 1 minute, or until well blended. Form mixture into a ball. Wrap in waxed paper and chill 1 hour. Clean mixer bowl and beater.

To make Filling:

Melt remaining 1 tablespoon butter in 10" skillet over medium heat. Add mushrooms and onions. Cook and stir until tender. Remove from heat. Cool slightly.

Divide chilled dough into 24 pieces. Press each piece into miniature muffin cup (greased, if desired).

For Filling:

Place egg, remaining 1 teaspoon flour, and thyme in mixer bowl. Attach bowl and flat beater to mixer. Turn to Speed 6 and beat about 30 seconds. Stir in cheese and cooled mushroom mixture. Spoon into pastry-lined muffin cups. Bake at 375°F for 15 to 20 minutes, or until egg mixture is puffed and golden brown. Serve warm.

Yield: 12 servings (2 tartlets per serving).

Per serving: About 98 cal, 4 g protein, 8 g carb, 6 g fat, 33 mg chol, 83 mg sodium.

Stuffed New Potatoes

8 *small new red potatoes, boiled in skins*

$\frac{1}{4}$ *cup reduced-fat sour cream*

1 *tablespoon margarine or butter, melted*

$\frac{1}{4}$ *teaspoon garlic salt*

$\frac{1}{4}$ *teaspoon dried thyme leaves*

$\frac{1}{4}$ *cup finely chopped green onions*

$\frac{1}{4}$ *cup finely shredded Cheddar cheese*
Paprika, if desired

Cut potatoes in half. Scoop out insides of potatoes, leaving $\frac{1}{8}$ " shells. Place insides of potatoes in mixer bowl. Attach bowl and flat beater to mixer. Turn to Speed 2 and mix about 1 minute. Add sour cream, margarine, garlic salt, and thyme. Turn to Speed 2 and mix about 30 seconds. Stop and scrape bowl. Turn to Speed 2 and mix about 30 seconds. Turn to Stir Speed and add onions, mixing just until blended.

Spoon or pipe potato mixture into potato shells. Place filled shells in shallow baking dish. Bake at 375°F for 20 to 25 minutes, or until thoroughly heated. Sprinkle with cheese and paprika, if desired. Bake 5 minutes longer, or until cheese is melted. Serve warm.

Yield: 8 servings (2 potato halves per serving).

Per serving: About 58 cal, 2 g protein, 6 g carb, 3 g fat, 5 mg chol, 108 mg sodium.

Sweet Potato Puff

2 *medium sweet potatoes, cooked and peeled*

$\frac{1}{2}$ *cup low-fat milk*

$\frac{1}{8}$ *cup sugar*

2 *eggs*

2 *tablespoons butter or margarine*

$\frac{1}{2}$ *teaspoon nutmeg*

$\frac{1}{2}$ *teaspoon cinnamon*

Place potatoes in mixer bowl. Attach bowl and flat beater to mixer. Turn to Speed 2 and mix about 30 seconds. Add milk, sugar, eggs, 2 tablespoons butter, nutmeg, and cinnamon. Turn to Speed 4 and beat about 1 minute. Spread mixture in greased 9" pie plate. Bake at 400°F for 20 minutes, or until set. Clean bowl and beater.

Place all Topping ingredients in mixer bowl. Attach bowl and flat beater to mixer. Turn to Stir Speed and mix about 15 seconds. Spread on hot puff. Bake 10 minutes longer.

Yield: 6 servings ($\frac{1}{2}$ cup per serving).

Per serving: About 268 cal, 6 g protein, 35 g carb, 12 g fat, 2 mg chol, 176 mg sodium.

Crunchy Praline Topping

2 *tablespoons butter or margarine, melted*

$\frac{3}{4}$ *cup corn flakes*

$\frac{1}{4}$ *cup chopped walnuts or pecans*

$\frac{1}{4}$ *cup firmly packed brown sugar*

Mashed Potatoes

- 5 *large potatoes (about 2½ lbs), peeled, quartered, and boiled*
- ½ *cup low-fat milk, heated*
- 2 *tablespoons butter or margarine*
- 1 *teaspoon salt*
- ⅛ *teaspoon black pepper*

Warm mixer bowl and flat beater with hot water; dry. Place hot potatoes in bowl. Attach bowl and flat beater to mixer. Gradually turn to Speed 2 and mix about 1 minute, or until smooth.

Add all remaining ingredients. Turn to Speed 4 and beat about 30 seconds, or until milk is absorbed. Gradually turn to Speed 6 and beat about 1 minute, or until fluffy. Stop and scrape bowl. Exchange flat beater for wire whip. Turn to Speed 10 and whip 2 to 3 minutes.

Yield: 9 servings (¾ cup per serving).

Per serving: About 111 cal, 2 g protein, 19 g carb, 3 g fat, 8 mg chol, 296 mg sodium.

VARIATIONS

Garlic Mashed Potatoes

Substitute 1 teaspoon garlic salt for salt.

Per serving: About 111 cal, 2 g protein, 19 g carb, 3 g fat, 8 mg chol, 239 mg sodium.

Parmesan Mashed Potatoes

Increase milk to ¾ cup. Add ½ cup grated Parmesan cheese with milk.

Per serving: About 205 cal, 6 g protein, 32 g carb, 6 g fat, 7 mg chol, 524 mg sodium.

Sour Cream-Chive Mashed Potatoes

Substitute ¼ cup reduced-fat sour cream for ¼ cup milk. Add 2 tablespoons chopped fresh chives.

Per serving: About 178 cal, 4 g protein, 32 g carb, 4 g fat, 2 mg chol, 417 mg sodium.

Herbed Whipped Squash

- 1 large butternut squash, baked (about 3 cups cooked)
- $\frac{1}{4}$ cup butter or margarine, melted
- $\frac{1}{2}$ teaspoon dried tarragon leaves
- $\frac{1}{8}$ teaspoon salt
- $\frac{1}{8}$ teaspoon black pepper

Scoop cooked squash out of shell and place in mixer bowl. Attach bowl and wire whip to mixer. Turn to Speed 4 and beat about 30 seconds. Add all remaining ingredients. Turn to Speed 2 and mix about 30 seconds. Turn to Speed 4 and beat about 2 minutes.

Yield: 6 servings ($\frac{1}{2}$ cup per serving).

Per serving: About 107 cal, 1 g protein, 11 g carb, 7 g fat, 0 mg chol, 137 mg sodium.

Black Bean Frittata

- 2 cups fat-free egg substitute or 8 eggs
- $\frac{1}{4}$ cup low-fat milk
- 1 tablespoon oil
- $\frac{1}{2}$ medium red bell pepper, chopped
- 4 green onions, sliced
- 1 can (16 oz) black beans, rinsed and drained
- 1 cup shredded Monterey Jack cheese

Place egg substitute and milk in mixer bowl. Attach bowl and wire whip to mixer. Turn to Speed 2 and mix about 30 seconds. Set aside.

Heat oil in large skillet over medium heat until oil sizzles. Add bell pepper and onions. Cook about 1 minute, or until slightly tender. Stir in beans. Cook about 1 minute, or until thoroughly heated.

Reduce heat to medium-low. Pour egg mixture over vegetables. Cook about 6 minutes, or until almost set. As bottom of egg mixture sets, gently lift edges with spatula and let uncooked egg run to the bottom of the pan. Cook, covered, about 2 minutes, or until top is set but still shiny. Sprinkle with cheese. Cook, covered, about 1 minute, or until cheese melts.

Yield: 6 servings.

Per serving: About 208 cal, 18 g protein, 15 g carb, 8 g fat, 18 mg chol, 463 mg sodium.

Tip: For browned top on frittata, place under broiler about 1 minute, or until cheese is browned and bubbly.

Garden Quiche

<i>Baked Pastry Shell</i> (see "KitchenAid Pie Pastry" recipe)	Follow procedure for Baked Pastry Shell. Cool 10 minutes.
1 <i>tablespoon oil</i>	Meanwhile, heat oil in large nonstick skillet over medium-high heat. Add onion and bell pepper. Cook about 1 minute, stirring frequently. Add mushrooms. Cook and stir about 2 minutes, or until vegetables are tender. Set aside.
1 <i>small onion, chopped</i>	Place eggs, milk, parsley, salt, and hot pepper sauce in mixer bowl. Attach bowl and wire whip to mixer. Turn to Speed 2 and mix 1 to 2 minutes.
1 <i>medium green bell pepper, chopped</i>	Sprinkle half of cheese in pastry shell. Top with vegetables. Pour egg mixture over vegetables. Top with remaining cheese. Bake at 350°F for 30 to 35 minutes, or until knife inserted in center comes out clean. Let stand about 5 minutes before serving.
8 <i>oz sliced fresh mushrooms</i>	Yield: 8 servings.
6 <i>eggs</i>	Per serving (filling and crust): About 264 cal, 12 g protein, 17 g carb, 16 g fat, 172 mg chol, 561 mg sodium.
1/2 <i>cup low-fat milk</i>	
1 <i>tablespoon chopped fresh parsley</i>	
1 <i>teaspoon salt</i>	
5 <i>drops hot pepper sauce</i>	
1 <i>cup (4 oz) reduced-fat shredded Swiss cheese</i>	

Cheese-Stuffed Shells

1/2 <i>cup fat-free egg substitute or 2 eggs</i>	Place egg substitute, ricotta cheese, mozzarella cheese, Parmesan cheese, parsley, and seasoning in mixer bowl. Attach bowl and flat beater to mixer. Turn to Speed 2 and mix about 30 seconds, or until combined.
1 <i>container (15 oz) no-fat ricotta cheese</i>	Fill each shell with 2 to 3 tablespoons cheese mixture. Place filled shells in 13 x 9 x 2" baking pan. Pour Marinara Sauce over shells. Cover pan with foil. Bake at 350°F for 30 to 35 minutes, or until bubbly.
2 <i>cups shredded part-skim mozzarella cheese</i>	Yield: 4 to 6 servings.
1/4 <i>cup grated Parmesan cheese</i>	Per serving: About 527 cal, 46 g protein, 56 g carb, 15 g fat, 57 mg chol, 865 mg sodium.
2 <i>teaspoons dried parsley leaves</i>	
2 <i>teaspoons no-salt herb and garlic seasoning</i>	
24 <i>jumbo pasta shells, cooked and drained</i>	
2 <i>cups prepared Marinara Sauce</i>	

Quick Yellow Cake

- 2¼ cups all-purpose flour
- 1½ cups sugar
- 3 teaspoons baking powder
- ½ teaspoon salt
- ½ cup shortening
- 1 cup low-fat milk
- 1 teaspoon vanilla
- 2 eggs

Combine dry ingredients in mixer bowl. Add shortening, milk, and vanilla. Attach bowl and flat beater to mixer. Turn to Speed 2 and mix about 1 minute. Stop and scrape bowl. Add eggs. Continuing on Speed 2, mix about 30 seconds. Stop and scrape bowl. Turn to Speed 6 and beat about 1 minute.

Pour batter into two greased and floured 8 or 9" round baking pans. Bake at 350°F for 30 to 35 minutes, or until toothpick inserted in center comes out clean. Cool 10 minutes. Remove from pans. Cool completely on wire rack. Frost if desired.

Yield: 12 to 16 servings.

Per serving: About 272 cal, 4 g protein, 42 g carb, 10 g fat, 37 mg chol, 175 mg sodium.

Easy White Cake

- 2 cups all-purpose flour
- 1½ cups sugar
- 3 teaspoons baking powder
- ½ teaspoon salt
- ½ cup shortening
- 1 cup low-fat milk
- 1 teaspoon vanilla
- 4 egg whites

Combine dry ingredients in mixer bowl. Add shortening, milk, and vanilla. Attach bowl and flat beater to mixer. Turn to Speed 2 and mix about 1 minute. Stop and scrape bowl. Add egg whites. Turn to Speed 6 and beat about 1 minute, or until smooth and fluffy.

Pour batter into two greased and floured 8 or 9" round baking pans. Bake at 350°F for 30 to 35 minutes, or until toothpick inserted in center comes out clean. Cool 10 minutes. Remove from pans. Cool completely on wire rack. Frost if desired.

Yield: 12 to 16 servings.

Per serving: About 267 cal, 4 g protein, 42 g carb, 9 g fat, 2 mg chol, 183 mg sodium.

Caramel Walnut Banana Torte

Topping

- 1 cup firmly packed brown sugar
- ½ cup butter or margarine
- ¼ cup whipping cream
- 1 cup chopped walnuts

Cake

- 1½ cups sugar
- ½ cup butter or margarine, softened
- 1 cup (2 medium) mashed ripe banana
- 1 teaspoon vanilla
- 3 eggs
- 2½ cups all-purpose flour
- 1¼ teaspoons baking powder
- 1 teaspoon baking soda
- ½ teaspoon salt
- ¾ cup buttermilk

Filling

- ½ cup sugar
- 3 tablespoons all-purpose flour
- ¼ teaspoon salt
- 1 cup low-fat milk
- 1 egg, beaten
- 1 teaspoon vanilla
- 1 tablespoon butter or margarine
- 2 medium bananas, thinly sliced
- ½ cup whipping cream, whipped

To Make Topping:

Place brown sugar, butter, and cream in small saucepan. Heat over low heat just until butter melts, stirring constantly. Pour over bottoms of three 8 or 9" round baking pans. Sprinkle with walnuts.

To Make Cake:

Place sugar and butter in mixer bowl. Attach bowl and flat beater to mixer. Turn to Speed 2 and mix about 30 seconds. Stop and scrape bowl. Add banana and vanilla. Continuing on Speed 2, mix about 30 seconds. Continuing on Speed 2, add eggs, one at a time, mixing about 15 seconds after each addition. Stop and scrape bowl.

Combine flour, baking powder, baking soda, and salt in small bowl. Add half of flour mixture to sugar mixture in mixer bowl. Turn to Speed 2 and mix about 30 seconds. Add buttermilk and remaining flour mixture. Gradually turn to Speed 6 and beat about 30 seconds. Spread batter evenly over nut mixture in pans. Bake at 350°F for 25 to 30 minutes, or until toothpick inserted in center comes out clean. Cool in pans about 3 minutes. Remove from pans and cool completely on wire racks.

To Make Filling:

Combine sugar, flour, and salt in medium saucepan. Gradually stir in milk. Heat to boiling over medium heat, stirring constantly. Stir about ¼ cup hot mixture into beaten egg in separate bowl. Pour egg mixture into saucepan. Cook until mixture is bubbly, stirring constantly. Remove from heat. Stir in vanilla and butter. Cool slightly. Refrigerate 1 hour while cake is cooling.

To assemble torte, place one cake layer, nut side up, on large plate. Spread with half of Filling. Arrange half of banana slices over Filling. Top with second layer, nut side up. Spread with remaining Filling and banana slices. Top with remaining cake layer, nut side up. Top torte with whipped cream. Store in refrigerator.

Yield: 16 to 20 servings.

Per serving: About 451 cal, 7 g protein, 65 g carb, 19 g fat, 58 mg chol, 384 mg sodium.

Angel Food Cake

1¼ cups all-purpose flour

1½ cups sugar, divided

1½ cups egg whites (about 12 to 15 egg whites)

1½ teaspoons cream of tartar

¼ teaspoon salt

1½ teaspoons vanilla or ½ teaspoon almond extract

Mix flour and ½ cup sugar in small bowl. Set aside.

Place egg whites in mixer bowl. Attach bowl and wire whip to mixer. Gradually turn to Speed 6 and whip 30 to 60 seconds, or until egg whites are frothy.

Add cream of tartar, salt, and vanilla. Turn to Speed 8 and whip 2 to 2½ minutes, or until whites are almost stiff but not dry. Turn to Speed 2. Gradually add remaining 1 cup sugar and mix about 1 minute. Stop and scrape bowl.

Remove bowl from mixer. Spoon flour-sugar mixture, one-fourth at a time, over egg whites. Fold in gently with spatula, just until blended.

Pour batter into ungreased 10" tube pan. With knife, gently cut through batter to remove large air bubbles. Bake at 375°F for 35 minutes, or until crust is golden brown and cracks are very dry. Immediately invert cake onto funnel or soft drink bottle. Cool completely. Remove from pan.

Yield: 16 servings.

Per serving: About 124 cal, 4 g protein, 27 g carb, 0 g fat, 0 mg chol, 79 mg sodium.

Old-Fashioned Pound Cake

- 3 cups all-purpose flour
- 2 cups sugar
- 3 teaspoons baking powder
- ½ teaspoon salt
- 2 cups butter, softened
- ½ cup low-fat milk
- 1 teaspoon vanilla
- 1 teaspoon almond extract
- 6 eggs

Combine dry ingredients in mixer bowl. Add butter, milk, vanilla, and almond extract. Attach bowl and flat beater to mixer. Turn to Stir Speed and mix about 1 minute. Stop and scrape bowl. Turn to Speed 6 and beat about 2 minutes. Stop and scrape bowl.

Turn to Speed 2 and add eggs, one at a time, mixing about 15 seconds after each addition. Turn to Speed 4 and beat about 30 seconds.

Pour batter into greased and floured 10" tube pan. Bake at 350°F for 1 hour 15 minutes, or until toothpick inserted in center comes out clean. Cool completely on wire rack. Remove cake from pan.

Yield: 16 servings.

Per serving: About 419 cal, 5 g protein, 44 g carb, 25 g fat, 143 mg chol, 378 mg sodium.

Double Chocolate Pound Cake

- 3 cups all-purpose flour
- 2 cups sugar
- ½ cup unsweetened Dutch-processed cocoa powder
- 3 teaspoons baking powder
- ½ teaspoon salt
- 1 cup butter, softened
- 1¼ cups low-fat milk
- 1 teaspoon vanilla
- 5 eggs

Combine dry ingredients in mixer bowl. Add butter, milk, and vanilla. Attach bowl and flat beater to mixer. Turn to Stir Speed and mix about 1 minute. Stop and scrape bowl. Turn to Speed 6 and beat about 2 minutes. Stop and scrape bowl.

Turn to Speed 2 and add eggs, one at a time, mixing about 15 seconds after each addition. Turn to Speed 4 and beat about 30 seconds.

Pour batter into greased and floured 10" tube pan. Bake at 325°F for 1 hour 20 minutes, or until toothpick inserted in center comes out clean. Cool completely on wire rack. Remove cake from pan and drizzle with Chocolate Glaze.

Chocolate Glaze

- 2 squares (1 oz each) unsweetened chocolate
- 3 tablespoons margarine or butter
- 1 cup powdered sugar
- ¾ teaspoon vanilla
- 2 tablespoons hot water

To Make Chocolate Glaze:

Melt chocolate and margarine in small saucepan over low heat. Remove from heat. Stir in powdered sugar and vanilla. Stir in water, 1 teaspoon at a time, until glaze is of desired consistency.

Yield: 16 servings.

Per serving: About 390 cal, 6 g protein, 55 g carb, 18 g fat, 99 mg chol, 289 mg sodium.

Chocolate Cake

- 2 cups all-purpose flour
- 1½ cups sugar
- 1 teaspoon baking powder
- ½ teaspoon baking soda
- ½ teaspoon salt
- ½ cup shortening
- 1 cup low-fat milk
- 1 teaspoon vanilla
- 2 eggs
- 2 squares (1 oz each) unsweetened chocolate, melted

Combine dry ingredients in mixer bowl. Add shortening, milk, and vanilla. Attach bowl and flat beater to mixer. Turn to Speed 2 and mix about 1 minute. Stop and scrape bowl. Add eggs and chocolate. Continuing on Speed 2, mix about 30 seconds. Stop and scrape bowl. Turn to Speed 6 and beat about 1 minute.

Pour batter into two greased and floured 8 or 9" round baking pans. Bake at 350°F for 30 to 35 minutes, or until toothpick inserted in center comes out clean. Cool 10 minutes. Remove from pans. Cool completely on wire rack. Frost if desired.

Yield: 12 to 16 servings.

Per serving: About 285 cal, 4 g protein, 41 g carb, 12 g fat, 37 mg chol, 185 mg sodium.

Sunshine Chiffon Cake

- 2 cups all-purpose flour
- 1½ cups sugar
- 1 tablespoon baking powder
- ½ teaspoon salt
- ¾ cup cold water
- ½ cup oil
- 7 egg yolks, beaten
- 1 teaspoon vanilla
- 2 teaspoons grated lemon rind
- 7 egg whites
- ½ teaspoon cream of tartar

Combine flour, sugar, baking powder, and salt in mixer bowl. Add water, oil, egg yolks, vanilla, and lemon rind. Attach bowl and wire whip to mixer. Turn to Speed 4 and beat about 1 minute. Stop and scrape bowl. Continuing on Speed 4, beat about 15 seconds. Pour mixture into another bowl. Clean mixer bowl and wire whip.

Place egg whites and cream of tartar in mixer bowl. Attach bowl and wire whip to mixer. Turn to Speed 8 and whip 2 to 2½ minutes, or until whites are stiff but not dry.

Remove bowl from mixer. Gradually add flour mixture to egg whites. Fold in gently with spatula, just until blended.

Pour batter into ungreased 10" tube pan. Bake at 325°F for 60 to 75 minutes, or until top springs back when lightly touched. Immediately invert cake onto funnel or soft drink bottle. Cool completely. Remove from pan. Drizzle with Lemon Glaze.

Lemon Glaze

- 1 cup powdered sugar
- 1 tablespoon butter or margarine, softened
- 2-3 tablespoons lemon juice

To Make Lemon Glaze:

Combine powdered sugar and butter in small bowl. Stir in lemon juice, 1 tablespoon at a time, until glaze is of desired consistency.

Yield: 16 servings.

Per serving: About 256 cal, 4 g protein, 38 g carb, 10 g fat, 93 mg chol, 152 mg sodium.

Chocolate Almond Brownie Cake

Cake

- 7 squares (1 oz each) semisweet chocolate
- ½ cup butter or margarine
- 3 eggs, separated
- ½ cup sugar
- ½ teaspoon almond extract
- 2 tablespoons all-purpose flour

Glaze

- 1 square (1 oz) semi-sweet chocolate
- 1 teaspoon shortening

Topping

- ½ cup whipping cream
- 1 tablespoon powdered sugar
- ¼ teaspoon almond extract
- 2 tablespoons sliced almonds

To Make Cake:

Melt chocolate and butter in medium saucepan over low heat, stirring constantly. Remove from heat; cool slightly.

Place egg whites in mixer bowl. Attach bowl and wire whip to mixer. Turn to Speed 8 and whip 1 to 2 minutes, or until stiff peaks form. Place egg whites in another bowl. Clean mixer bowl and wire whip.

Place chocolate mixture, sugar, and almond extract in mixer bowl. Attach bowl and flat beater to mixer. Turn to Speed 4 and beat about 1 minute. Stop and scrape bowl. Continuing on Speed 4, add egg yolks, one at a time, beating about 30 seconds after each addition.

Continuing on Speed 4, add flour and beat about 15 seconds. Gently fold in egg whites with spatula.

Spoon batter into 8" springform pan that has been greased and floured on the bottom only. Bake at 375°F for 20 to 25 minutes, or until set in center. Cool completely on wire rack before glazing. Clean mixer bowl.

To Make Glaze:

Melt chocolate and shortening in small saucepan over low heat, stirring to blend. Drizzle over cake.

To Make Topping:

Place cream, powdered sugar, and almond extract in mixer bowl. Attach wire whip and bowl to mixer. Turn to Speed 10 and whip 30 to 60 seconds, or until stiff peaks form. Pipe or spoon whipped cream in ring over top of cake. Sprinkle with almonds. Store in refrigerator.

Yield: 16 servings.

Per serving: About 180 cal, 3 g protein, 17 g carb, 13 g fat, 58 mg chol, 74 mg sodium.

Applesauce Cake

1½ cups all-purpose flour
1 cup whole wheat flour
1½ cups sugar
1 teaspoon baking powder
1 teaspoon baking soda
½ teaspoon salt
1½ teaspoons cinnamon
½ teaspoon nutmeg
1½ cups applesauce
½ cup margarine or butter, melted
2 eggs
1 cup chopped, peeled apple
½ cup chopped walnuts
Caramel Creme Frosting, if desired (see "Carmel Creme Frosting" recipe)

Combine dry ingredients in mixer bowl. Add applesauce, margarine, and eggs. Attach bowl and flat beater to mixer. Turn to Speed 2 and mix about 1 minute. Stop and scrape bowl. Turn to Speed 4 and beat about 30 seconds. Turn to Stir Speed and add apple and walnuts, mixing just until blended.

Pour batter into greased and floured 13 x 9 x 2" baking pan. Bake at 350°F for 35 to 40 minutes, or until toothpick inserted in center comes out clean. Cool completely on wire rack. Frost with Caramel Creme Frosting, if desired.

Yield: 12 to 16 servings (frosting for 2-layer or 13 x 9 x 2" cake).

Per serving: About 318 cal, 5 g protein, 51 g carb, 11 g fat, 36 mg chol, 315 mg sodium.

Spice Cake

2¼ cups all-purpose flour
1 cup firmly packed brown sugar
½ cup sugar
1 teaspoon baking soda
½ teaspoon salt
1 teaspoon cinnamon
½ teaspoon cloves
½ teaspoon nutmeg
1 cup buttermilk
½ cup shortening
1 teaspoon vanilla
3 eggs
½ cup raisins
Orange Cream Cheese Frosting, if desired (see "Orange Creme Cheese Frosting" recipe)

Combine dry ingredients in mixer bowl. Add buttermilk, shortening, vanilla, and eggs. Attach bowl and flat beater to mixer. Turn to Speed 2 and mix about 1 minute. Stop and scrape bowl. Turn to Speed 4 and beat about 30 seconds. Turn to Stir Speed and add raisins, mixing just until blended.

Pour batter into greased and floured 13 x 9 x 2" baking pan. Bake at 350°F for 35 to 40 minutes, or until toothpick inserted in center comes out clean. Cool completely on wire rack. Frost with Orange Cream Cheese Frosting, if desired.

Yield: 12 to 16 servings (frosting for 2-layer or 13 x 9 x 2" cake).

Per serving: About 310 cal, 5 g protein, 50 g carb, 10 g fat, 54 mg chol, 240 mg sodium.

Chocolate Frosting

- 1 cup butter, softened
- 2 tablespoons light corn syrup
- 4 cups powdered sugar
- 2 squares (1 oz each) unsweetened chocolate, melted

Place butter in mixer bowl. Attach bowl and flat beater to mixer. Turn to Speed 4 and beat about 1½ minutes, or until creamy. Stop and scrape bowl. Add corn syrup. Turn to Speed 2 and mix well. Stop and scrape bowl.

Turn to Stir Speed. Gradually add powdered sugar, mixing until blended. Turn to Speed 4 and beat about 1 minute. Stop and scrape bowl. Turn to Speed 2. Slowly add melted chocolate and mix about 1½ minutes. Stop and scrape bowl. Turn to Speed 4 and beat about 1 minute.

Yield: 12 to 16 servings (frosting for 2-layer or 13 x 9 x 2" cake).

Per serving: About 325 cal, 1 g protein, 44 g carb, 18 g fat, 41 mg chol, 160 mg sodium.

Buttercream Frosting

- ½ cup butter, softened
- ¼ cup cream or evaporated milk
- 1 teaspoon vanilla
- ¼ teaspoon salt
- 4 cups powdered sugar, divided
- Low-fat milk, if necessary

Place butter in mixer bowl. Attach bowl and flat beater to mixer. Turn to Speed 4 and beat about 1 minute, or until creamy. Stop and scrape bowl. Add cream, milk, vanilla, salt, and 1 cup powdered sugar. Turn to Stir Speed and mix about 30 seconds. Stop and scrape bowl. Turn to Speed 2 and mix about 1½ minutes, or until well blended. Stop and scrape bowl.

Turn to Stir Speed. Gradually add remaining 3 cups powdered sugar and mix until blended. Stop and scrape bowl, if necessary. Add milk, 1 teaspoon at a time, if necessary. Turn to Speed 4 and beat about 1 minute, or until smooth.

Yield: 12 to 16 servings (frosting for 2-layer or 13 x 9 x 2" cake).

Per serving: About 208 cal, 0 g protein, 40 g carb, 6 g fat, 16 mg chol, 99 mg sodium.

Caramel Creme Frosting

- ½ cup margarine or butter*
- 1 cup firmly packed brown sugar*
- ¼ cup low-fat milk*
- 1 cup miniature marshmallows*
- 2 cups powdered sugar*
- ½ teaspoon vanilla*

Melt margarine in medium saucepan. Add brown sugar and milk; mix. Heat to boiling. Cook about 1 minute, stirring constantly. Remove from heat. Add marshmallows. Stir until marshmallows melt and mixture is smooth.

Place powdered sugar in mixer bowl. Add brown sugar mixture and vanilla. Attach bowl and flat beater to mixer. Turn to Stir Speed and mix about 30 seconds. Turn to Speed 4 and beat about 1 minute, or until smooth and creamy. Spread on cake while warm.

Yield: 12 to 16 servings (frosting for 2-layer or 13 x 9 x 2" cake).

Per serving: About 228 cal, 0 g protein, 41 g carb, 7 g fat, 0 mg chol, 98 mg sodium.

Fluffy KitchenAid Frosting

- 1½ cups sugar*
- ½ teaspoon cream of tartar*
- ½ teaspoon salt*
- ½ cup water*
- 1½ tablespoons light corn syrup*
- 2 egg whites*
- 1½ teaspoons vanilla*

Place sugar, cream of tartar, salt, water, and corn syrup in saucepan. Cook and stir over medium heat until sugar is completely dissolved, forming a syrup.

Place egg whites in mixer bowl. Attach bowl and wire whip to mixer. Turn to Speed 10 and whip about 45 seconds, or until whites begin to hold shape. Continuing on Speed 10, slowly pour hot syrup into egg whites in a fine stream and whip 1 to 1½ minutes. Add vanilla and whip about 5 minutes longer, or until frosting loses its gloss and stands in stiff peaks. Frost cake immediately.

Yield: 12 to 16 servings (frosting for 2-layer or 13 x 9 x 2" cake).

Per serving: About 109 cal, 1 g protein, 27 g carb, 0 g fat, 0 mg chol, 101 mg sodium.

Orange Cream Cheese Frosting

- 4 cups powdered sugar*
- 1 package (8 oz) light cream cheese*
- 1 teaspoon orange juice*
- ½ teaspoon grated orange peel*

Place all ingredients in mixer bowl. Attach bowl and flat beater to mixer. Turn to Stir Speed and mix about 30 seconds, or until blended. Turn to Speed 4 and beat about 2 minutes, or until smooth and creamy.

Yield: 12 to 16 servings (frosting for 2-layer or 13 x 9 x 2" cake).

Per serving: About 196 cal, 2 g protein, 41 g carb, 3 g fat, 7 mg chol, 107 mg sodium.

Creamy No-Cook Mints

- 3 oz light cream cheese
- $\frac{1}{4}$ teaspoon mint flavoring
- 2 drops green food color or color of choice
- $4\frac{1}{4}$ - $4\frac{1}{2}$ cups powdered sugar
- Superfine sugar

Place cream cheese, flavoring, and food color in mixer bowl. Attach bowl and flat beater to mixer. Turn to Speed 2 and mix about 30 seconds, or until smooth. Continuing on Speed 2, gradually add powdered sugar and mix about $1\frac{1}{2}$ minutes, or until mixture becomes very stiff.

To make mints, dip individual flexible candy molds in superfine sugar. Press in mint mixture. Turn out onto waxed paper covered with superfine sugar. Repeat until all mixture is used. OR: Shape mixture into $\frac{3}{4}$ " balls, using about 1 teaspoon for each ball. Roll in superfine sugar. Place on waxed paper covered with superfine sugar. Flatten slightly with thumb to form $\frac{1}{4}$ " thick patties. If desired, press back of fork lightly on patties to form ridges.

Store mints, tightly covered, in refrigerator. Mints also freeze well.

Yield: 42 servings (2 candies per serving).

Per serving: About 54 cal, 0 g protein, 13 g carb, 0 g fat, 1 mg chol, 12 mg sodium.

Chocolate Fudge

- Butter
- 2 cups sugar
- $\frac{1}{8}$ teaspoon salt
- $\frac{3}{4}$ cup evaporated milk
- 1 teaspoon light corn syrup
- 2 squares (1 oz each) unsweetened chocolate
- 2 tablespoons butter or margarine
- 1 teaspoon vanilla
- 2 cup chopped walnuts or pecans

Butter sides of heavy 2-qt saucepan. Combine sugar, salt, evaporated milk, corn syrup, and chocolate in pan. Cook and stir over medium heat until chocolate melts and sugar dissolves. Cook to soft ball stage (236°F) without stirring. Remove immediately from heat. Add butter without stirring. Cool to lukewarm (110°F). Stir in vanilla.

Pour mixture into mixer bowl. Attach bowl and flat beater to mixer. Turn to Speed 2 and mix about 8 minutes, or until fudge stiffens and loses its gloss. Quickly turn to Stir Speed and add walnuts, mixing just until blended. Spread in buttered 9 x 9 x 2" baking pan. Cool at room temperature. Cut into 1" squares when firm.

Yield: 64 servings (1 square per serving).

Per serving: About 59 cal, 1 g protein, 7 g carb, 3 g fat, 1 mg chol, 12 mg sodium.

Divinity

- 3 cups sugar
- $\frac{3}{4}$ cup light corn syrup
- $\frac{1}{2}$ cup water
- 2 egg whites
- 1 teaspoon almond extract
- 1 cup chopped walnuts or pecans

Place sugar, corn syrup, and water in heavy saucepan. Cook and stir over medium heat to hard ball stage (248°F). Remove from heat and let stand until temperature drops to 220°F, without stirring.

Place egg whites in mixer bowl. Attach bowl and wire whip to mixer. Turn to Speed 8 and whip about 1 minute, or until soft peaks form. Gradually add syrup in a fine stream and whip about 2½ minutes longer.

Turn to Speed 4. Add almond extract and whip 20 to 25 minutes, or until mixture starts to become dry. Turn to Stir Speed and add walnuts, mixing just until blended.

Drop mixture from measuring tablespoon onto waxed paper or greased baking sheet to form patties.

Yield: 20 servings (2 pieces per serving).

Per serving: About 192 cal, 2 g protein, 40 g carb, 4 g fat, 0 mg chol, 15 mg sodium.

Chocolate Chip Cookies

- 1 cup granulated sugar
- 1 cup brown sugar
- 1 cup butter or margarine, softened
- 2 eggs
- $\frac{1}{2}$ teaspoons vanilla
- 1 teaspoon baking soda
- 1 teaspoon salt
- 3 cups all-purpose flour
- 12 oz semisweet chocolate chips

Place sugars, butter, eggs, and vanilla in mixer bowl. Attach bowl and flat beater to mixer. Turn to Speed 2 and mix about 30 seconds. Stop and scrape bowl. Turn to Speed 4 and beat about 30 seconds. Stop and scrape bowl.

Turn to Stir Speed. Gradually add baking soda, salt, and flour to sugar mixture and mix about 2 minutes. Turn to Speed 2 and mix about 30 seconds. Stop mixer and scrape bowl. Add chocolate chips. Turn to Stir Speed and mix about 15 seconds.

Drop by rounded teaspoonfuls onto greased baking sheets, about 2" apart. Bake at 375°F for 10 to 12 minutes. Remove from baking sheets immediately and cool on wire racks.

Yield: 54 servings (1 cookie per serving).

Per serving: About 117 cal, 1 g protein, 17 g carb, 5 g fat, 8 mg chol, 106 mg sodium.

VARIATIONS

2 cups raisins, coconut, or chopped walnuts may be substituted for chocolate chips.

Macadamia Chocolate Chunk Cookies

- 1 cup firmly packed brown sugar
 $\frac{3}{4}$ cup sugar
1 cup margarine or butter, softened
2 teaspoons vanilla
2 eggs
 $2\frac{1}{4}$ cups all-purpose flour, divided
 $\frac{1}{2}$ cup unsweetened cocoa powder
1 teaspoon baking soda
 $\frac{1}{2}$ teaspoon salt
1 package (8 oz) semisweet baking chocolate, cut into small chunks
1 jar ($3\frac{1}{2}$ oz) macadamia nuts, coarsely chopped
- Place brown sugar, sugar, margarine, vanilla, and eggs in mixer bowl. Attach bowl and flat beater to mixer. Turn to Speed 2 and mix about 30 seconds. Stop and scrape bowl. Turn to Speed 4 and beat about 1 minute. Stop and scrape bowl.
- Add 1 cup flour, cocoa powder, baking soda, and salt. Turn to Stir Speed and mix about 30 seconds. Gradually add remaining $1\frac{1}{4}$ cups flour and mix about 30 seconds longer. Turn to Speed 2 and mix about 30 seconds. Turn to Stir Speed and add chocolate chunks and nuts, mixing just until blended.
- Drop by rounded teaspoonfuls onto greased baking sheets, about 2" apart. Bake at 325°F for 12 to 13 minutes, or until edges are set. Do not overbake. Cool on baking sheets about 1 minute. Remove to wire racks and cool completely.
- Yield: 48 servings (1 cookie per serving).
Per serving: About 125 cal, 2 g protein, 16 g carb, 7 g fat, 9 mg chol, 107 mg sodium.

Sugar Cookies

- 1 cup margarine or butter, softened
1 teaspoon vanilla
 $\frac{3}{4}$ cup sugar
2 eggs, beaten
1 teaspoon cream of tartar
 $\frac{1}{2}$ teaspoon baking soda
 $\frac{1}{4}$ teaspoon nutmeg
 $\frac{1}{4}$ teaspoon salt
2 cups all-purpose flour
Sugar
- Place margarine and vanilla in mixer bowl. Attach bowl and flat beater to mixer. Turn to Speed 6 and beat about 2 minutes, or until mixture is smooth. Gradually add $\frac{3}{4}$ cup sugar and beat about $1\frac{1}{2}$ minutes longer. Add eggs and beat about 30 seconds. Stop and scrape bowl.
- Turn to Stir Speed. Gradually add cream of tartar, baking soda, nutmeg, salt, and flour to sugar mixture. Mix about 1 minute, or until well blended.
- Drop by rounded teaspoonfuls onto greased baking sheets, about 3" apart. Bake at 400°F for 6 to 8 minutes. Sprinkle with sugar while still hot. Remove from baking sheets immediately and cool on wire racks.
- Yield: 48 servings (1 cookie per serving).
Per serving: About 69 cal, 1 g protein, 8 g carb, 4 g fat, 9 mg chol, 70 mg sodium.

Peanut Butter Cookies

<i>½ cup peanut butter</i>	<p>Place peanut butter and butter in mixer bowl. Attach bowl and flat beater to mixer. Turn to Speed 6 and beat about 1 minute, or until mixture is smooth. Stop and scrape bowl. Add sugars, egg, and vanilla. Turn to Speed 4 and beat about 1 minute. Stop and scrape bowl.</p> <p>Turn to Stir Speed. Gradually add all remaining ingredients to sugar mixture and mix about 30 seconds. Turn to Speed 2 and mix about 30 seconds.</p> <p>Roll dough into 1" balls. Place about 2" apart on ungreased baking sheets. Press flat with fork in a criss-cross pattern to ¼" thickness.</p> <p>Bake at 375°F for 10 to 12 minutes, or until golden brown. Remove from baking sheets immediately and cool on wire racks.</p> <p>Yield: 36 servings (1 cookie per serving).</p> <p>Per serving: About 83 cal, 2 g protein, 10 g carb, 4 g fat, 6 mg chol, 81 mg sodium.</p>
<i>½ cup butter or margarine, softened</i>	
<i>½ cup granulated sugar</i>	
<i>½ cup brown sugar</i>	
<i>1 egg</i>	
<i>½ teaspoon vanilla</i>	
<i>½ teaspoon baking soda</i>	
<i>¼ teaspoon salt</i>	
<i>1¼ cups all-purpose flour</i>	

Nutty Shortbread Bars

<i>1 cup butter or margarine, softened</i>	<p>Place butter and brown sugar in mixer bowl. Attach bowl and flat beater to mixer. Turn to Speed 2 and mix about 1 minute. Stop and scrape bowl. Add flour, baking powder, and salt. Turn to Speed 2 and mix about 1½ minutes, or until soft dough forms.</p> <p>Press dough into greased 15½ x 10½ x 1" baking pan. Beat egg whites with fork until slightly foamy. Brush dough with egg whites, using only as much as needed to cover lightly. Sprinkle with chopped walnuts.</p> <p>Bake at 375°F for 20 to 25 minutes. Cut into bars while warm. Cool on wire rack.</p> <p>Yield: 30 servings (1 bar per serving).</p> <p>Per serving: About 139 cal, 2 g protein, 14 g carb, 8 g fat, 17 mg chol, 114 mg sodium.</p>
<i>1 cup firmly packed brown sugar</i>	
<i>2 cups all-purpose flour</i>	
<i>1 teaspoon baking powder</i>	
<i>½ teaspoon salt</i>	
<i>2 egg whites</i>	
<i>1 cup chopped walnuts or pecans</i>	

Fudge Brownies

- 1 cup margarine or butter, softened
- 4 squares (1 oz each) unsweetened chocolate
- 2 cups sugar
- 1 teaspoon vanilla
- 3 eggs
- 1 cup all-purpose flour
- ½ teaspoon salt
- 1 cup chopped walnuts or pecans

Melt ½ cup margarine and chocolate in small saucepan over low heat; cool. Place remaining ½ cup margarine, sugar, and vanilla in mixer bowl. Attach bowl and flat beater to mixer. Turn to Speed 2 and mix about 30 seconds. Turn to Speed 6 and beat about 2 minutes. Turn to Speed 4. Add eggs, one at a time, beating about 15 seconds after each addition. Stop and scrape bowl.

Add cooled chocolate mixture. Turn to Speed 2 and mix about 30 seconds. Stop and scrape bowl. Add all remaining ingredients. Turn to Stir Speed and mix about 30 seconds, or until well blended.

Pour into greased and floured 13 x 9 x 2" baking pan. Bake at 350°F for 45 minutes. Cool in pan on wire rack and cut.

Yield: 36 servings (1 brownie per serving).

Per serving: About 143 cal, 2 g protein, 16 g carb, 9 g fat, 18 mg chol, 93 mg sodium.

Lemon Cream Cheese Bars

Crust

- 2 cups all-purpose flour
- ½ cup powdered sugar
- 1 cup (2 sticks) chilled butter, cut into chunks

Place Crust ingredients in mixer bowl. Attach bowl and flat beater to mixer. Turn to Stir Speed and mix about 1 minute, or until well blended and mixture starts to stick together. Press into ungreased 15½ x 10½ x 1" baking pan. Bake at 350°F for 14 to 16 minutes, or until set.

NOTE: Check crust after 10 minutes and prick with fork if it puffs up during baking. Remove from oven.

Cream Cheese Filling

- 1 package (8 oz) light cream cheese
- ½ cup powdered sugar
- 2 tablespoons flour
- 2 eggs
- 1 teaspoon vanilla

Meanwhile, clean mixer bowl and beater. Place Cream Cheese Filling ingredients in mixer bowl. Attach bowl and flat beater to mixer. Turn to Stir Speed and mix about 30 seconds. Turn to Speed 4 and beat about 2 minutes, or until smooth and creamy. Pour over partially baked Crust. Bake at 350°F for 6 to 7 minutes, or until filling is slightly set. Remove from oven.

Lemon Filling

- 4 eggs
- 2 cups granulated sugar
- ¼ cup all-purpose flour
- 1 teaspoon grated lemon peel
- ¼ cup lemon juice
- Powdered sugar, if desired

Meanwhile, clean mixer bowl and beater. Place all Lemon Filling ingredients, except lemon juice, in mixer bowl. Attach bowl and flat beater to mixer. Turn to Stir Speed and mix about 30 seconds. Turn to Speed 2. Gradually add lemon juice and mix about 30 seconds, or until well blended. Pour over Cream Cheese Filling. Bake at 350°F for 14 to 16 minutes, or until filling is set.

NOTE: Filling may puff up during baking but will fall when removed from oven. Sprinkle with powdered sugar, if desired. Cool completely in pan.

Yield: 48 servings (1 bar per serving).

Per serving: About 115 cal, 2 g protein, 16 g carb, 5 g fat, 39 mg chol, 65 mg sodium.

KitchenAid Pie Pastry

2¼ cups
all-purpose flour
¾ teaspoon salt
½ cup shortening,
well chilled
2 tablespoons butter
or margarine,
well chilled
5-6 tablespoons
cold water

Place flour and salt in mixer bowl. Attach bowl and flat beater to mixer. Turn to Stir Speed and mix about 15 seconds. Cut shortening and butter into pieces and add to flour mixture. Turn to Stir Speed and mix 30 to 45 seconds, or until shortening particles are size of small peas.

Continuing on Stir Speed, add water, 1 tablespoon at a time, mixing until all particles are moistened and dough begins to hold together.

Divide dough in half. Pat each half into a smooth ball and flatten slightly. Wrap in plastic wrap. Chill in refrigerator 15 minutes.

Roll one half of dough to ⅛" thickness between waxed paper. Fold pastry into quarters. Ease into 8 or 9" pie plate and unfold, pressing firmly against bottom and sides. Continue with one of the procedures that follow.

For One-crust Pie: Fold edge under. Crimp, as desired. Add desired pie filling. Bake as directed.

For Two-crust Pie: Trim pastry even with edge of pie plate. Using second half of dough, roll out another pastry crust. Add desired pie filling. Top with second pastry crust. Seal edge. Crimp, as desired. Cut slits for steam to escape. Bake as directed.

For Baked Pastry Shell: Fold edge under. Crimp, as desired. Prick sides and bottom with fork. Bake at 450°F for 8 to 10 minutes, or until lightly browned. Cool completely on wire rack and fill.

Alternate Method for Baked Pastry Shell: Fold edge under. Crimp, as desired. Line shell with foil. Fill with pie weights or dried beans. Bake at 450°F for 10 to 12 minutes, or until edges are lightly browned. Remove pie weights and foil. Cool completely on wire rack and fill.

Yield: 8 servings (two 8 or 9" crusts).

Per serving (one crust): About 134 cal, 2 g protein, 13 g carb, 8 g fat, 0 mg chol, 118 mg sodium.

Per serving (two crusts): About 267 cal, 4 g protein, 27 g carb, 16 g fat, 0 mg chol, 236 mg sodium.

Apple Pie

- 1 cup sugar
 - 2 tablespoons all-purpose flour
 - 1 teaspoon cinnamon
 - $\frac{1}{8}$ teaspoon nutmeg
 - $\frac{1}{8}$ teaspoon salt
 - 6-8 medium tart cooking apples, peeled, cored, and thinly sliced
 - 2 tablespoons margarine or butter
- KitchenAid Pie Pastry for Two-crust Pie (see "KitchenAid Pie Pastry" recipe)*

Combine sugar, flour, cinnamon, nutmeg, and salt in large bowl. Stir in apples.

Follow procedure for Two-crust Pie. Fill with apple mixture and dot with margarine. Sprinkle top crust with sugar, if desired.

Bake at 400°F for 50 minutes.

Yield: 8 servings.

Per serving (filling and crust): About 451 cal, 4 g protein, 68 g carb, 19 g fat, 0 mg chol, 301 mg sodium.

Country Pear Cobbler

Filling

- $\frac{3}{4}$ cup firmly packed brown sugar
- 3 tablespoons all-purpose flour
- $\frac{1}{8}$ teaspoon salt
- $\frac{1}{8}$ teaspoon nutmeg
- Dash cloves
- 2 tablespoons lemon juice
- 6-8 medium pears, peeled, cored, and thinly sliced

Combine all Filling ingredients, except pears, in large skillet. Stir in sliced pears. Cook over medium heat about 5 minutes, or until hot and bubbly, stirring gently. Set aside.

To Make Topping:

Place flour, sugar, baking powder, and baking soda in mixer bowl. Attach bowl and flat beater to mixer. Turn to Stir Speed and mix about 30 seconds. Add buttermilk and melted margarine. Continuing on Stir Speed, mix about 30 seconds, or just until blended.

Pour hot filling into 8 or 9" baking pan. Top evenly with large spoonfuls of topping. Sprinkle with 1 tablespoon sugar, if desired. Bake at 375°F for 30 to 35 minutes, or until pears are tender and bubbly and topping is golden brown. Serve warm with light cream, if desired.

Yield: 8 to 10 servings.

Per serving: About 276 cal, 3 g protein, 57 g carb, 5 g fat, 1 mg chol, 219 mg sodium.

Topping

- 1 cup all-purpose flour
- 2 tablespoons sugar
- 1 teaspoon baking powder
- $\frac{1}{2}$ teaspoon baking soda
- $\frac{1}{2}$ cup buttermilk
- 3 tablespoons margarine or butter, melted
- 1 tablespoon sugar, if desired
- Light cream, if desired

Vanilla Cream Pie

$\frac{1}{2}$ cup sugar
6 tablespoons all-purpose flour
 $\frac{1}{4}$ teaspoon salt
 $2\frac{1}{2}$ cups low-fat milk
3 egg yolks
1 tablespoon margarine or butter
1 teaspoon vanilla
KitchenAid Baked Pastry Shell
(see "KitchenAid Pie Pastry" recipe)

Combine sugar, flour, and salt in heavy saucepan. Add milk and cook over medium heat until thickened, stirring constantly. Reduce heat to low. Cook, covered, about 10 minutes longer, stirring occasionally. Set aside.

Place egg yolks in mixer bowl. Attach bowl and wire whip to mixer. Turn to Speed 8 and whip about 1 minute. Slowly stir small amount of milk mixture into yolks. Add yolk mixture to saucepan. Cook over medium heat 3 to 4 minutes, stirring constantly. Remove from heat. Add margarine and vanilla; cool. Pour into Baked Pastry Shell.

Meringue

$\frac{1}{4}$ teaspoon cream of tartar
 $\frac{1}{8}$ teaspoon salt
3 egg whites
 $\frac{1}{2}$ cup sugar

To make meringue, place cream of tartar, salt, and egg whites in mixer bowl. Attach bowl and wire whip to mixer. Gradually turn to Speed 8 and whip about 1 minute, or until soft peaks form. Turn to Speed 4. Gradually add sugar and whip about 1 minute, or until stiff peaks form.

Lightly pile meringue on pie and spread to edge. Bake at 325°F for 15 minutes, or until lightly browned.

Yield: 8 servings.

Per serving (filling and crust): About 332 cal, 7 g protein, 47 g carb, 13 g fat, 86 mg chol, 297 mg sodium.

Variations continued on next page.

VARIATIONS

Chocolate Cream Pie

Add 2 squares (1 oz each) melted, unsweetened chocolate to filling along with margarine and vanilla. Proceed as directed in "Vanilla Cream Pie" recipe.

Per serving (filling and crust): About 368 cal, 8 g protein, 49 g carb, 16 g fat, 86 mg chol, 298 mg sodium.

Banana Cream Pie

Slice 2 or 3 ripe bananas into pastry shell before adding filling. Proceed as directed in "Vanilla Cream Pie" recipe.

Per serving (filling and crust): About 359 cal, 8 g protein, 54 g carb, 13 g fat, 86 mg chol, 298 mg sodium.

Coconut Cream Pie

Add ½ cup flaked coconut to filling before adding to pastry shell. Before baking, sprinkle ¼ cup flaked coconut on meringue. Proceed as directed in "Vanilla Cream Pie" recipe.

Per serving (filling and crust): About 376 cal, 8 g protein, 51 g carb, 16 g fat, 86 mg chol, 320 mg sodium.

Lemony Light Cheesecake

Crust

- 15 *reduced-fat creme-filled chocolate sandwich cookies, finely crushed (about 1½ cups crumbs)*
- 2 *tablespoons butter or margarine, melted*

Filling

- 3 *packages (8 oz each) light cream cheese*
- 1 *cup sugar*
- 1 *tablespoon all-purpose flour*
- 4 *eggs*
- ¼ *cup lemon juice*
- 1 *teaspoon grated lemon peel*

Spray bottom and sides of 9" springform pan with no-stick cooking spray.

To Make Crust:

Combine cookie crumbs and butter in medium bowl; mix well. Press mixture firmly into bottom of springform pan. Chill while making Filling.

To Make Filling:

Place cream cheese, sugar, and flour in mixer bowl. Attach bowl and flat beater to mixer. Turn to Speed 2 and mix about 30 seconds. Stop and scrape bowl. Turn to Speed 2 and mix about 30 seconds longer. Stop and scrape bowl.

Add eggs, lemon juice, and lemon peel. Turn to Stir Speed and mix about 30 seconds. Stop and scrape bowl. Turn to Speed 2 and mix 15 to 30 seconds longer, just until blended. Do not overbeat. Pour Filling into Crust.

Place top oven rack in center of oven. Place pan of hot water on bottom rack of oven. Place cheesecake on rack in center of oven. Bake at 325°F for 50 to 60 minutes, or until cheesecake is set when pan is jiggled slightly. Do not overbake.

Turn off oven; open oven door. Let cheesecake stand in oven 30 minutes. Remove from oven. Cool completely on wire rack away from drafts. Cover and refrigerate 6 to 8 hours before serving.

Yield: 16 servings.

Per serving: About 169 cal, 6 g protein, 20 g carb, 7 g fat, 68 mg chol, 214 mg sodium.

Tawny Pumpkin Pie

- 1 *can (16 oz) pumpkin*
- ¾ *cup firmly packed brown sugar*
- 3 *eggs*
- 1 *teaspoon cinnamon*
- ½ *teaspoon ginger*
- ½ *teaspoon salt*
- ¼ *teaspoon cloves*
- 1¼ *cups low-fat milk*
- Pie Pastry for One-crust Pie (see "KitchenAid Pie Pastry" recipe)*

Place pumpkin, brown sugar, eggs, cinnamon, ginger, salt, and cloves in mixer bowl. Attach bowl and flat beater to mixer. Turn to Speed 2 and mix about 30 seconds. Stop and scrap bowl. Continuing on Speed 2, slowly add milk and mix about 1½ minutes.

Follow procedure for One-crust Pie. Fill with pumpkin mixture. Bake at 400°F for 40 to 50 minutes, or until knife inserted near center comes out clean.

Yield: 8 servings.

Per serving (filling and crust): About 280 cal, 6 g protein, 41 g carb, 11 g fat, 87 mg chol, 325 mg sodium.

General Instructions For Making And Kneading Yeast Dough with the Rapid Mix Method

"Rapid Mix" describes a bread baking method that calls for dry yeast to be mixed with other dry ingredients before liquid is added. In contrast, the traditional method is to dissolve yeast in warm water.

1. Place all dry ingredients including yeast into bowl, except last 1 to 2 cups flour.
2. Attach bowl and dough hook. Lock mixer head (tilt-head models) or raise mixer bowl (bowl-lift models). Turn to Speed 2 and mix about 15 seconds, or until ingredients are combined.
3. Continuing on Speed 2, gradually add liquid ingredients to flour mixture and mix 1 to 2 minutes longer. See Illustration A.

NOTE: If liquid ingredients are added too quickly, they will form a pool around the dough hook and slow down mixing process.

4. Continuing on Speed 2, gently add remaining flour, $\frac{1}{2}$ cup at a time. See Illustration B. Mix until dough clings to hook and cleans sides of bowl, about 2 minutes.
5. When dough clings to hook, knead on Speed 2 for 2 minutes, or until dough is smooth and elastic. See Illustration C.
6. Unlock and tilt back head (tilt-head models) or lower bowl (bowl-lift models) and remove dough from hook. Follow directions in recipe for rising, shaping and baking.



ILLUSTRATION A



ILLUSTRATION B



ILLUSTRATION C

When using the traditional method to prepare a favorite recipe, dissolve yeast in warm water in warmed bowl. Add remaining liquids and dry ingredients, except last 1 to 2 cups flour. Turn to Speed 2 and mix about 1 minute, or until ingredients are thoroughly mixed. Proceed with steps 4-6.

Both methods work equally well for bread preparation. However, the "Rapid Mix" method may be a bit faster and easier for new bread bakers. It is slightly more temperature tolerant because the yeast is mixed with dry ingredients rather than with warm liquid.

Bread Making Tips

Making bread with a mixer is quite different from making bread by hand. Therefore, it will take some practice before you are completely comfortable with the new process. For your convenience, we offer these tips to help you become accustomed to bread making the KitchenAid way.

- Start out with an easy recipe, like "Basic White Bread," until you are familiar with using the dough hook.
- Always use the dough hook to mix and knead yeast doughs.
- Do not exceed Speed 2 when using the dough hook.
- Do not use recipes calling for more than 8 cups all-purpose flour or 6 cups whole-wheat flour when making dough with a 4½ qt mixer.
- Do not use recipes calling for more than 10 cups all-purpose flour or 6 cups whole-wheat flour when making dough with a 5 qt mixer.
- Use a candy or other kitchen thermometer to assure that liquids are at temperature specified in the recipe. Liquids at higher temperature can kill yeast, while liquids at lower temperatures will retard yeast growth.
- Warm all ingredients to room temperature to insure proper rising of dough. If yeast is to be dissolved in bowl, always warm bowl first by rinsing with warm water to avoid cooling of liquids.
- Allow bread to rise in a warm place, 80°F to 85°F, free from draft, unless otherwise specified in recipe.

- Here are some alternative rising methods to use: (1) The bowl containing the dough can be placed on a wire rack over a pan of hot water. (2) The bowl can be placed on the top rack of an unheated oven; put a pan of hot water on the rack below. (3) Turn the oven to 400°F for 1 minute; then turn it off; place the bowl on the center rack of the oven and close the door.

Cover bowl with waxed paper, if desired. Always cover with towel to retain warmth in the bowl and to keep the dough from drafts.

- Recipe rising times may vary due to temperature and humidity in your kitchen. Dough has doubled in bulk when indentation remains after tips of fingers are pressed lightly and quickly into dough.
- Most bread recipes give a range for the amount of flour to be used. Enough flour has been added when the dough clings to the hook and cleans sides of bowl. If dough is sticky or humidity is high, slowly add more flour, about ½ cup at a time but do not exceed recommended flour capacity. Knead after each addition until flour is completely worked into dough. If too much flour is added, a dry loaf will result.
- Some types of dough, especially those made with whole grain flours, may not form a ball on the hook. However, as long as the hook comes in contact with the dough, kneading will be accomplished.

Bread Making Tips

- Some large recipes and soft doughs may occasionally climb over the collar of the hook. This usually indicates that the dough is sticky and more flour should be added. The sooner all the flour is added, the less likely the dough will climb the hook. For such recipes, try starting with all but the last cup of flour in the initial mixing process. Then add the remaining flour as quickly as possible.
- When done, yeast breads and rolls should be deep golden brown in color. Other tests for doneness of breads are: Bread pulls away from the sides of pan, and tapping on the top of the loaf produces a hollow sound. Turn loaves and rolls onto racks immediately after baking to avoid sogginess.

Shaping a Loaf



Divide dough in half. On lightly floured surface, roll each half into a rectangle, approximately 9 x 14". A rolling pin will smooth dough and remove gas bubbles.



Starting at a short end, roll dough tightly. Pinch dough to seal seam.



Pinch ends and turn under. Place, seam side down, in loaf pan. Follow directions in recipe for rising and baking.

Basic White Bread

½ cup low-fat milk
3 tablespoons sugar
2 teaspoons salt
3 tablespoons butter
or margarine
2 packages active dry
yeast
1½ cups warm water
(105°F to 115°F)
5-6 cups all-purpose
flour

Place milk, sugar, salt, and butter in small saucepan. Heat over low heat until butter melts and sugar dissolves. Cool to lukewarm.

Dissolve yeast in warm water in warmed mixer bowl. Add lukewarm milk mixture and 4½ cups flour. Attach bowl and dough hook to mixer. Turn to Speed 2 and mix about 1 minute.

Continuing on Speed 2, add remaining flour, ½ cup at a time, and mix about 2 minutes, or until dough clings to hook and cleans sides of bowl. Knead on Speed 2 about 2 minutes longer, or until dough is smooth and elastic. Dough will be slightly sticky to the touch.

Place dough in greased bowl, turning to grease top. Cover. Let rise in warm place, free from draft, about 1 hour, or until doubled in bulk.

Punch dough down and divide in half. Shape each half into a loaf, see "Shaping a Loaf" section. Place in greased 8½ x 4½ x 2½" baking pans. Cover. Let rise in warm place, free from draft, about 1 hour, or until doubled in bulk.

Bake at 400°F for 30 minutes, or until golden brown. Remove from pans immediately and cool on wire racks.

Yield: 32 servings (16 slices per loaf).

Per serving: About 95 cal, 3 g protein, 18 g carb, 1 g fat, 0 mg chol, 148 mg sodium.

Variations continued on next page.

VARIATIONS

Cinnamon Bread

Prepare dough, divide, and roll out each half to a rectangle, see "Shaping a Loaf" section. Mix together $\frac{1}{2}$ cup sugar and 2 teaspoons cinnamon in small bowl. Spread each rectangle with 1 tablespoon softened butter or margarine. Sprinkle with half of sugar mixture. Finish rolling and shaping loaves. Place in well-greased $8\frac{1}{2}$ x $4\frac{1}{2}$ x $2\frac{1}{2}$ " baking pans. Cover. Let rise in warm place, free from draft, about 1 hour, or until doubled in bulk. If desired, brush tops with beaten egg white. Bake at 375°F for 40 to 45 minutes, or until golden brown. Remove from pans immediately and cool on wire racks.

Yield: 32 servings (16 slices per loaf).

Per serving: About 111 cal, 3 g protein, 21 g carb, 2 g fat, 0 mg chol, 152 mg sodium.

Sixty-Minute Rolls

Increase yeast to 3 packages and sugar to $\frac{1}{4}$ cup. Mix and knead dough as directed for "Basic White Bread" recipe. Place in greased bowl, turning to grease top. Cover. Let rise in warm place, free from draft, about 15 minutes. Turn dough onto lightly floured surface. Shape as desired (see the following suggestions). Cover. Let rise in slightly warm oven (90°F) about 15 minutes. Bake at 425°F for 12 minutes, or until golden brown. Remove from pans immediately and cool on wire racks.

Curlicues: Divide dough in half and roll each half to 12 x 9" rectangle. Cut 12 equal strips about 1" wide. Roll each strip tightly to form a coil, tucking ends underneath. Place on greased baking sheets about 2" apart.

Cloverleaves: Divide dough into 24 equal pieces. Form each piece into a ball and place in greased muffin pan. With scissors, cut each ball in half, then quarters.

Yield: 24 servings (1 roll per serving).

Per serving: About 130 cal, 4 g protein, 25 g carb, 2 g fat, 0 mg chol, 198 mg sodium.

Whole Grain Wheat Bread

*½ cup plus
1 tablespoon
brown sugar*
*2 cups warm water
(105°F to 115°F)*
*2 packages active
dry yeast*
*5-6 cups whole-wheat
flour*
¾ cup powdered milk
2 teaspoons salt
½ cup oil

Dissolve 1 tablespoon brown sugar in warm water in small bowl. Add yeast and let mixture stand.

Place 4 cups flour, powdered milk, ½ cup brown sugar, and salt in mixer bowl. Attach bowl and dough hook to mixer. Turn to Speed 2 and mix about 15 seconds. Continuing on Speed 2, gradually add yeast mixture and oil to flour mixture and mix about 1½ minutes longer. Stop and scrape bowl, if necessary.

Continuing on Speed 2, add remaining flour, ½ cup at a time, and mix about 2 minutes, or until dough clings to hook and cleans sides of bowl. Knead on Speed 2 about 2 minutes longer.

NOTE: Dough may not form a ball on hook. However, as long as hook comes in contact with dough, kneading will be accomplished. Do not add more than the maximum amount of flour specified or a dry loaf will result.

Place dough in greased bowl, turning to grease top. Cover. Let rise in warm place, free from draft, about 1 hour, or until doubled in bulk.

Punch dough down and divide in half. Shape each half into a loaf, see "Shaping a Loaf" section. Place in greased 8½ x 4½ x 2½" baking pan. Cover. Let rise in warm place, free from draft, about 1 hour, or until doubled in bulk.

Bake at 400°F for 15 minutes. Reduce oven temperature to 350°F and bake 30 minutes longer. Remove from pans immediately and cool on wire racks.

Yield: 32 servings (16 slices per loaf).

Per serving: About 112 cal, 4 g protein, 19 g carb, 3 g fat, 2 mg chol, 146 mg sodium.

French Bread

- 2 packages active dry yeast
- 2½ cups warm water (105°F to 115°F)
- 1 tablespoon salt
- 1 tablespoon butter or margarine, melted
- 7 cups all-purpose flour
- 2 tablespoons cornmeal
- 1 egg white
- 1 tablespoon cold water

Dissolve yeast in warm water in warmed mixer bowl. Add salt, butter, and flour. Attach bowl and dough hook to mixer. Turn to Speed 2 and mix about 1 minute, or until well blended. Knead on Speed 2 about 2 minutes longer. Dough will be sticky.

Place dough in greased bowl, turning to grease top. Cover. Let rise in warm place, free from draft, about 1 hour, or until doubled in bulk.

Punch dough down and divide in half. Roll each half into 12 x 15" rectangle. Roll dough tightly, from longest side, tapering ends if desired. Place loaves on greased baking sheets that have been dusted with cornmeal. Cover. Let rise in warm place, free from draft, about 1 hour, or until doubled in bulk.

With sharp knife, make 4 diagonal cuts on top of each loaf. Bake at 450°F for 25 minutes. Remove from oven. Beat egg white and water together with a fork. Brush each loaf with egg mixture. Return to oven and bake 5 minutes longer. Remove from baking sheets immediately and cool on wire racks.

Yield: 30 servings (15 slices per loaf).

Per serving: About 114 cal, 3 g protein, 23 g carb, 1 g fat, 0 mg chol, 221 mg sodium.

Honey Oatmeal Bread

1½ cups water
½ cup honey
½ cup butter or
margarine
5½-6½ cups all-purpose
flour
1 cup quick cooking
oats
2 teaspoons salt
2 packages active dry
yeast
2 eggs
1 egg white
1 tablespoon water
Oatmeal

Place water, honey, and butter in small saucepan. Heat over low heat until mixture is very warm (120°F to 130°F).

Place 5 cups flour, oats, salt, and yeast in mixer bowl. Attach bowl and dough hook to mixer. Turn to Speed 2 and mix about 15 seconds. Continuing on Speed 2, gradually add warm mixture to flour mixture and mix about 1 minute. Add eggs and mix about 1 minute longer.

Continuing on Speed 2, add remaining flour, ½ cup at a time, and mix about 2 minutes, or until dough clings to hook and cleans sides of bowl. Knead on Speed 2 about 2 minutes longer.

Place dough in greased bowl, turning to grease top. Cover. Let rise in warm place, free from draft, about 1 hour, or until doubled in bulk.

Punch dough down and divide in half. Shape each half into a loaf, see "Shaping a Loaf" section. Place in greased 8½ x 4½ x 2½" baking pans. Cover. Let rise in warm place, free from draft, about 1 hour, or until doubled in bulk.

Beat egg white and water together with a fork. Brush tops of loaves with mixture. Sprinkle with oatmeal. Bake at 375°F for 40 minutes. Remove from pans immediately and cool on wire racks.

Yield: 32 servings (16 slices per loaf).

Per serving: About 134 cal, 4 g protein, 24 g carb, 3 g fat, 13 mg chol, 162 mg sodium.

Light Rye Bread

¼ cup honey
¼ cup light molasses
2 teaspoons salt
2 tablespoons butter
or margarine
2 tablespoons
caraway seed
1 cup boiling water
2 packages active dry
yeast
¾ cup warm water
(105°F to 115°F)
2 cups rye flour
3½-4 cups all-purpose
flour

Place honey, molasses, salt, butter, caraway seed, and boiling water in small bowl. Stir until honey dissolves. Cool to lukewarm.

Dissolve yeast in warm water in warmed mixer bowl. Add lukewarm honey mixture, rye flour, and 1 cup all-purpose flour. Attach bowl and dough hook to mixer. Turn to Speed 2 and mix about 1 minute, or until well mixed. Stop and scrape bowl if necessary.

Continuing on Speed 2, add remaining all-purpose flour, ½ cup at a time, and mix about 2 minutes, or until dough clings to hook and cleans sides of bowl. Knead on Speed 2 about 2 minutes longer.

Place dough in greased bowl, turning to grease top. Cover. Let rise in warm place, free from draft, about 1 hour, or until doubled in bulk.

Punch dough down and divide in half. Shape each half into a round loaf. Place on two greased baking sheet. Cover. Let rise in warm place, free from draft, 45 to 60 minutes, or until doubled in bulk.

Bake at 350°F for 30 to 45 minutes. Cover loaves with aluminum foil for last 15 minutes if tops brown too quickly. Remove from baking sheets immediately and cool on wire racks.

Yield: 32 servings (16 slices per loaf).

Per serving: About 96 cal, 2 g protein, 20 g carb, 1 g fat, 0 mg chol, 143 mg sodium.

Dill Batter Bread

- 2 *packages active dry yeast*
½ *cup warm water (105°F to 115°F)*
4 *tablespoons honey, divided*
2 *cups large curd cottage cheese*
2 *tablespoons grated fresh onion*
4 *tablespoons butter or margarine, softened*
3 *tablespoons dill seed*
3 *teaspoons salt*
½ *teaspoon baking soda*
2 *eggs*
1 *cup whole wheat flour*
3-3½ *cups all-purpose flour*
- Dissolve yeast in warm water in warmed mixer bowl. Add 1 tablespoon honey and let stand 5 minutes.
- Add cottage cheese, remaining 3 tablespoons honey, onion, butter, dill seed, salt, and soda. Attach bowl and flat beater to mixer. Turn to Stir Speed and mix about 30 seconds. Add eggs. Continuing on Stir Speed, mix about 15 seconds.
- Add whole wheat flour and 2 cups all-purpose flour. Turn to Speed 2 and mix about 2 minutes, or until combined. Continuing on Speed 2, add remaining flour, a little at a time, and mix until dough forms a stiff batter. Stop and scrape bowl, if necessary. Continuing on Speed 2, mix about 2 minutes longer.
- Cover. Let rise in warm place, free from draft, about 1 hour, or until doubled in bulk.
- Stir dough down. Place in two well-greased 8½ x 4½ x 2½" baking pans or two well-greased 1½ to 2-qt casseroles. Cover. Let rise in warm place, free from draft, about 45 minutes, or until doubled in bulk.
- Bake at 350°F for 40 to 50 minutes. Remove from pans immediately and cool on wire racks.
- Yield: 32 servings (16 slices per loaf).
- Per serving: About 98 cal, 4 g protein, 15 g carb, 3 g fat, 15 mg chol, 298 mg sodium.

Vegetable Cheese Bread

2 packages active dry yeast	Dissolve yeast in warm water in small bowl. Set aside.
1 cup warm water (105°F to 115°F)	Combine whole wheat flour, 2 cups all-purpose flour, sugar, and salt in mixer bowl. Attach bowl and dough hook to mixer. Turn to Speed 2 and mix about 30 seconds. Continuing on Speed 2, gradually add yeast mixture, butter, and warm milk to flour mixture and mix about 1½ minutes. Stop and scrape bowl. Add tomatoes, onion, parsley, and cheese. Turn to Speed 2 and mix about 30 seconds. Continuing on Speed 2, add remaining flour, ½ cup at a time and mix about 2 minutes, or until dough clings to hook and cleans sides of bowl. Knead on Speed 2 about 2 minutes longer.
2 cups whole-wheat flour	
3-3½ cups all-purpose flour	
2 tablespoons sugar	
2 teaspoons salt	
2 tablespoons butter or margarine	
1 cup warm low-fat milk (105°F to 115°F)	
¼ cup chopped sun-dried tomatoes	
2 teaspoons instant minced onion	
2 teaspoons dried parsley leaves	
½ cup shredded sharp Cheddar cheese	
	Place dough in greased bowl, turning to grease top. Cover. Let rise in warm place, free from draft, about 1 hour, or until doubled in bulk.
	Punch dough down and divide in half. Shape each half into a loaf, see "Shaping a Loaf" section. Place in well-greased 8½ x 4½ x 2½" baking pans. Cover. Let rise in warm place, free from draft, 45 to 60 minutes, or until doubled in bulk.
	Bake at 375°F for 40 minutes. Remove from pans immediately and cool on wire rack.
	NOTE: Loaves may need to be released by running a knife around edges of pans.
	Yield: 32 servings (16 slices per loaf).
	Per serving: About 99 cal, 3 g protein, 18 g carb, 2 g fat, 2 mg chol, 160 mg sodium.

Blueberry Oat Bread

2 cups all-purpose flour
1 cup rolled oats
1 cup sugar
1½ teaspoons baking powder
½ teaspoon baking soda
¼ teaspoon salt
¼ teaspoon allspice
¾ cup low-fat milk
½ cup butter or margarine, melted
1 tablespoon grated orange peel
2 eggs
1¼ cups fresh or frozen blueberries (not thawed)

Combine dry ingredients in mixer bowl. Add milk, butter, orange peel, and eggs. Attach bowl and flat beater to mixer. Turn to Stir Speed and mix about 30 seconds. With spoon, gently stir in blueberries.

Spoon batter into 9 x 5 x 3" baking pan that has been greased on the bottom only. Bake at 350°F for 55 to 65 minutes, or until toothpick inserted in center comes out clean. Cool in pan 10 minutes. Remove from pan and cool completely on wire rack.

Yield: 16 servings (16 slices per loaf).

Per serving: About 196 cal, 3 g protein, 31 g carb, 7 g fat, 27 mg chol, 177 mg sodium.

Basic Sweet Dough

¾ cup low-fat milk
½ cup sugar
1¼ teaspoons salt
½ cup butter or margarine
2 packages active dry yeast
½ cup warm water (105°F to 115°F)
3 eggs, room temperature
5½-6½ cups all-purpose flour

Place milk, sugar, salt, and butter in small saucepan. Heat over low heat until butter melts and sugar dissolves. Cool to lukewarm.

Dissolve yeast in warm water in warmed mixer bowl. Add lukewarm milk mixture, eggs, and 5 cups flour. Attach bowl and dough hook to mixer. Turn to Speed 2 and mix about 2 minutes.

Continuing on Speed 2, add remaining flour, ½ cup at a time, and mix about 2 minutes, or until dough clings to hook and cleans sides of bowl. Knead on Speed 2 about 2 minutes longer.

Place dough in greased bowl, turning to grease top. Cover. Let rise in warm place, free from draft, about 1 hour, or until doubled in bulk.

Punch dough down and shape as desired for rolls or coffee cakes.

Cinnamon Swirl Rounds

- 1 cup firmly packed brown sugar
- 1 cup sugar
- ½ cup butter or margarine, softened
- ¼ cup all-purpose flour
- 1½ tablespoons cinnamon
- ½ cup chopped walnuts or pecans
- 1 recipe Basic Sweet Dough (see "Basic Sweet Dough" recipe)

Place brown sugar, sugar, butter, flour, cinnamon, and walnuts in mixer bowl. Attach bowl and flat beater to mixer. Turn to Speed 2 and mix about 1 minute.

Turn dough onto lightly floured surface. Roll dough to 10 x 24" rectangle. Spread sugar-cinnamon mixture evenly on dough. Roll dough tightly from long side to form 24" roll, pinching seam together. Cut into 24 slices, 1" each.

Place 12 rolls each in two greased 13 x 9 x 2" baking pans. Cover. Let rise in warm place, free from draft, 45 to 60 minutes, or until doubled in bulk.

Bake at 350°F for 20 to 25 minutes. Remove from pans immediately. Spoon Caramel Glaze over warm rolls.

Caramel Glaze

- ½ cup evaporated milk
- 2 tablespoons brown sugar
- 1½ cups powdered sugar
- 1 teaspoon vanilla

To Make Caramel Glaze:

Place evaporated milk and brown sugar in small saucepan. Cook over medium heat until mixture begins to boil, stirring constantly.

Place milk mixture, powdered sugar, and vanilla in mixer bowl. Attach bowl and flat beater to mixer. Turn to Speed 4 and beat about 2 minutes, or until creamy.

Yield: 24 servings (1 roll per serving)

Per serving: About 338 cal, 6 g protein, 57 g carb, 10 g fat, 28 mg chol, 219 mg sodium.

Rapid Mix Cool Rise White Bread

6-7 cups all-purpose flour
2 tablespoons sugar
3½ teaspoons salt
3 packages active dry yeast
¼ cup butter or margarine, softened
2 cups very warm water (120°F to 130°F)

Place 5½ cups flour, sugar, salt, yeast, and butter in mixer bowl. Attach bowl and dough hook to mixer. Turn to Speed 2 and mix about 20 seconds. Gradually add warm water and mix about 1½ minutes longer.

Continuing on Speed 2, add remaining flour, 2 cups at a time, and mix about 2 minutes, or until dough clings to hook and cleans sides of bowl. Knead on Speed 2 about 2 minutes longer.

Cover dough with plastic wrap and a towel. Let rest 20 minutes.

Divide dough in half. Shape each half into a loaf, see "Shaping a Loaf" section. Place in greased 8½ x 4½ x 2½" baking pans. Brush each loaf with oil and cover loosely with plastic wrap. Refrigerate 2 to 12 hours.

When ready to bake, gently uncover dough. Let stand at room temperature 10 minutes. Puncture any gas bubbles which may have formed.

Bake at 400°F for 35 to 40 minutes. Remove from pans immediately and cool on wire racks.

Yield: 32 servings (16 slices per loaf).

Per serving: About 110 cal, 3 g protein, 21 g carb, 2 g fat, 0 mg chol, 251 mg sodium.

Crusty Pizza Dough

1 package active dry yeast	Dissolve yeast in warm water in warmed mixer bowl. Add salt, olive oil, and 2½ cups flour. Attach bowl and dough hook to mixer. Turn to Speed 2 and mix about 1 minute.
1 cup warm water (105°F to 115°F)	
½ teaspoon salt	Continuing on Speed 2, add remaining flour, ½ cup at a time, and mix about 2 minutes, or until dough clings to hook and cleans sides of bowl. Knead on Speed 2 about 2 minutes longer.
2 teaspoons olive oil	
2½-3½ cups all-purpose flour	
1 tablespoon cornmeal	Place dough in greased bowl, turning to grease top. Cover. Let rise in warm place, free from draft, about 1 hour, or until doubled in bulk. Punch dough down.
	Brush 14" pizza pan with oil. Sprinkle with cornmeal. Press dough across bottom of pan, forming a collar around edge to hold toppings. Add toppings, as desired. Bake at 450°F for 15 to 20 minutes.
	Yield: 4 servings (¼ pizza per serving).
	Per serving: About 373 cal, 11 g protein, 74 g carb, 3 g fat, 0 mg chol, 271 mg sodium.

Banana Nut Bread

½ cup shortening	Place shortening and sugar in mixer bowl. Attach bowl and flat beater to mixer. Turn to Speed 6 and beat about 1 minute. Stop and scrape bowl.
½ cup sugar	
2 eggs	Continuing on Speed 6, beat about 1 minute longer. Add eggs. Turn to Speed 4 and beat about 30 seconds. Stop and scrape bowl. Turn to Speed 6 and beat about 1½ minutes.
1¾ cups all-purpose flour	
1 teaspoon baking powder	Combine flour, baking powder, baking soda, and salt in separate bowl. Add half of flour mixture and half of mashed banana to mixer bowl. Turn to Stir Speed and mix about 30 seconds. Add remaining flour and banana. Continuing on Stir Speed, mix about 30 seconds. Stop and scrape bowl. Add walnuts. Continuing on Stir Speed, mix about 15 seconds.
½ teaspoon baking soda	
½ teaspoon salt	
1 cup (2 medium) mashed ripe banana	Pour mixture into greased and floured 9 x 5 x 3" baking pan. Bake at 350°F for 40 to 45 minutes. Cool 5 minutes in pan. Remove from pan and cool completely on wire rack.
½ cup chopped walnuts or pecans	Yield: 16 servings (16 slices).
	Per serving: About 157 cal, 3 g protein, 21 g carb, 7 g fat, 27 mg chol, 131 mg sodium.

Baking Powder Biscuits

- 2 cups all-purpose flour
- 4 teaspoons baking powder
- ½ teaspoon salt
- ½ cup shortening
- ¾ cup low-fat milk
- Melted margarine or butter, if desired

Place flour, baking powder, salt, and shortening in mixer bowl. Attach bowl and flat beater to mixer. Turn to Stir Speed and mix about 1 minute. Stop and scrape bowl.

Add milk. Turn to Stir Speed and mix until dough starts to cling to beater. Avoid overbeating. Turn dough onto lightly floured surface and knead about 20 seconds, or until smooth. Pat or roll to ½" thickness. Cut with floured 2" biscuit cutter.

Place on greased baking sheets and brush with melted margarine, if desired. Bake at 450°F for 12 to 15 minutes. Serve immediately.

Yield: 12 servings (1 biscuit per serving).

Per serving: About 135 cal, 3 g protein, 17 g carb, 6 g fat, 1 mg chol, 183 mg sodium.

Bran Muffins

- 1 cup boiling water
- 1 cup wheat bran
- 1 cup firmly packed brown sugar
- ½ cup sugar
- ½ cup shortening
- 2 eggs
- 2 cups buttermilk
- 1 teaspoon vanilla
- 2½ cups all-purpose flour
- 2½ teaspoons baking soda
- 1 teaspoon baking powder
- ½ teaspoon salt
- 2 cups bran cereal flakes

Pour boiling water over bran in small bowl. Set aside.

Place brown sugar, sugar, and shortening in mixer bowl. Attach bowl and flat beater to mixer. Turn to Speed 4 and beat about 1 minute. Add eggs. Turn to Speed 4 and beat about 30 seconds. Add buttermilk and vanilla. Turn to Stir Speed and mix about 30 seconds. Stop and scrape bowl.

Add flour, baking soda, baking powder, and salt. Turn to Stir Speed and mix about 30 seconds. Stop and scrape bowl. Turn to Stir Speed and mix about 30 seconds longer. Gradually turn to Speed 4 and beat about 1 minute. Add moistened bran and bran cereal flakes. Turn to Stir Speed and mix about 30 seconds, or until ingredients are combined.

Spoon batter into greased or paper-lined muffin pans. Bake at 400°F for 20 minutes, or until toothpick inserted in center comes out clean. Remove from pans immediately. Serve warm.

Yield: 24 servings (1 muffin per serving).

Per serving: About 170 cal, 3 g protein, 29 g carb, 5 g fat, 19 mg chol, 242 mg sodium.

Tip: Batter can be refrigerated in tightly covered container up to 1 week.

Sour Cream Coffee Cake

<i>½ cup firmly packed brown sugar</i>	Combine brown sugar, cinnamon, and walnuts in small bowl. Set aside.
<i>1½ teaspoons cinnamon</i>	Combine flour, sugar, baking powder, baking soda, and salt in mixer bowl. Add margarine, sour cream, and vanilla. Attach bowl and flat beater to mixer. Turn to Stir Speed and mix about 30 seconds, or until ingredients are combined. Stop and scrape bowl. Turn to Speed 4 and beat about 1½ minutes. Stop and scrape bowl.
<i>1 cup chopped walnuts or pecans</i>	
<i>3 cups all-purpose flour</i>	
<i>1½ cups sugar</i>	
<i>3 teaspoons baking powder</i>	Turn to Stir Speed and add eggs, one at a time, mixing about 15 seconds after each addition. Turn to Speed 2 and mix about 30 seconds.
<i>1 teaspoon baking soda</i>	
<i>½ teaspoon salt</i>	Spread half of batter in greased and floured 13 x 9 x 2" baking pan or 10" tube pan. Sprinkle with half of cinnamon-sugar mixture. Spread remaining batter in pan and top with remaining cinnamon-sugar mixture. Bake at 350°F for 50 to 60 minutes. Serve warm.
<i>1 cup margarine or butter, softened</i>	
<i>1 cup reduced-fat sour cream</i>	
<i>1 teaspoon vanilla</i>	
<i>3 eggs</i>	Yield: 16 servings. Per serving: About 362 cal, 6 g protein, 47 g carb, 17 g fat, 44 mg chol, 349 mg sodium.

Caramel Apple Kuchen

<i>1 recipe Basic Sweet Dough (see "Basic Sweet Dough" recipe)</i>	Divide dough in half. Press each half into greased 13 x 9 x 2" baking pan. Gently press edges ½" up sides.
<i>2 cups firmly packed brown sugar</i>	Cover. Let rise in warm place, free from draft, 45 to 60 minutes, or until doubled in bulk.
<i>6 tablespoons all-purpose flour</i>	Meanwhile, place brown sugar, flour, cinnamon, and margarine in mixer bowl. Attach bowl and flat beater to mixer. Turn to Speed 2 and mix about 1 minute.
<i>2 teaspoons cinnamon</i>	
<i>6 tablespoons margarine or butter, softened</i>	Arrange apple slices over dough in each of two pans. Sprinkle evenly with brown sugar mixture. Bake at 350°F for 35 to 45 minutes, or until golden brown and apples are tender. Serve warm.
<i>6-8 apples (8 cups), peeled and thinly sliced</i>	Yield: 24 servings (12 pieces per kuchen). Per serving: About 301 cal, 5 g protein, 54 g carb, 8 g fat, 27 mg chol, 207 mg sodium.

Pancakes

- 1½ cups all-purpose flour
- 2 teaspoons baking powder
- 1 teaspoon sugar
- ½ teaspoon salt
- ½ cup fat-free egg substitute or 2 eggs
- 1¼ cups low-fat milk
- 3 tablespoons shortening, melted

Combine flour, baking powder, sugar, and salt in mixer bowl. Add all remaining ingredients. Attach bowl and flat beater to mixer. Turn to Speed 4 and mix about 30 seconds, or until ingredients are combined. Stop and scrape bowl. Turn to Speed 4 and mix about 15 seconds, or until smooth.

Spray griddle or heavy skillet with no-stick cooking spray. Heat griddle to medium-high heat. Pour about ½ cup batter for each pancake onto griddle. Cook 1 to 2 minutes, or until bubbles form on surface and edges become dry. Turn and cook 1 to 2 minutes longer, or until golden brown on underside.

Yield: 4 servings (2 pancakes per serving).

Per serving: About 318 cal, 11 g protein, 41 g carb, 11 g fat, 6 mg chol, 490 mg sodium.

Crispy Waffles

- 2 cups all-purpose flour
- 3 teaspoons baking powder
- 2 tablespoons sugar
- ½ teaspoon salt
- 2 eggs, separated
- 1¼ cups low-fat milk
- ¼ cup butter or margarine, melted

Combine flour, baking powder, sugar, and salt in mixer bowl. Add egg yolks, milk, and butter. Attach bowl and flat beater to mixer. Turn to Speed 4 and mix about 30 seconds, or until ingredients are combined. Stop and scrape bowl. Continuing on Speed 4, mix about 15 seconds, or until smooth. Pour mixture into another bowl. Clean mixer bowl.

Place egg whites in mixer bowl. Attach bowl and wire whip to mixer. Turn to Speed 8 and whip until whites are stiff but not dry. Gently fold egg whites into flour mixture.

Spray waffle iron with no-stick cooking spray. Heat waffle iron. Pour about ½ cup batter for each waffle onto iron. Bake 3 to 5 minutes, or until golden brown.

Yield: 6 servings (1 waffle per serving).

Per serving: About 287 cal, 8 g protein, 39 g carb, 10 g fat, 75 mg chol, 441 mg sodium.

Multifunction Attachment Pack

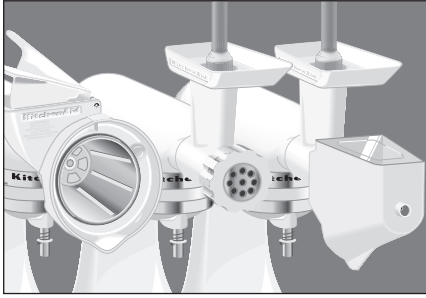

Model FPPA

KitchenAid has packaged its three most popular attachments in one carton. It includes a Rotor Slicer/Shredder (RVSA), Food Grinder (FGA), and Fruit/Vegetable Strainer Parts (FVSP).

Food Grinder



Model FGA

Grinds meat, firm fruits and vegetables, and dry bread.

Fruit/Vegetable Strainer



Model FVSFGA

Makes preparing jams, purées, sauces and baby foods quick and easy.

Food Tray

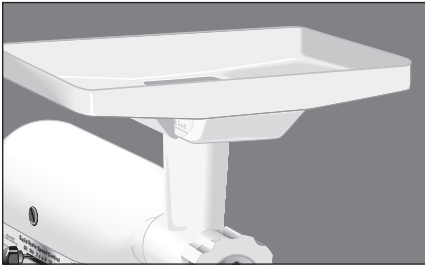

Model FT
Holds large quantities of food for quicker and easier juicing, puréeing and grinding. For use with FGA.

Sausage Stuffer



Model SSA
 $\frac{3}{8}$ " and $\frac{5}{8}$ " stuffing tubes make Bratwurst, Kielbasa, Italian or Polish sausage and breakfast links. For use with FGA.

Rotor Slicer/Shredder



Model RVSA
Includes 4 cones: thin and thick slicer, fine and coarse shredder.

Grain Mill



Model GMA
Grinds low-moisture grains from very fine to extra coarse textures.

Can Opener



Model CO
Opens cans quickly, leaves edges smooth and snag-free.

Pasta Roller Set



Model KPRA
Makes lasagna noodles, fettuccini and linguine fini. 3-piece set includes Roller, Fettuccine Cutter and Linguine Fini Cutter.

Citrus Juicer

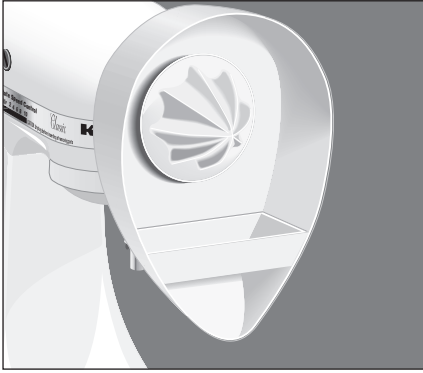

Model JE
Juices citrus fruits quickly and thoroughly, strains out pulp.

Water Jacket



Model K5AWJ
Fill with ice, cold or hot water to keep cold mixtures cold, hot ones hot.

Pouring Shield



Model KN1PS
Minimizes splash-out when adding ingredients.

Bowl Covers

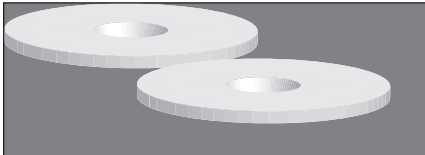

2 pack, non-sealing bowl covers are dishwasher-safe (top rack).

Mixer Covers



Model K45CR
(For 4½ qt mixers)

Model K5CR
(For 5 qt mixers)

To cover mixers when not in use.
Made of cotton and polyester, they are machine washable.



FOR THE WAY IT'S MADE.®

® Registered trademark/™ Trademark/
the shape of the mixer is a registered trademark of KitchenAid, U.S.A.