

This Owner's Manual is provided and hosted by Appliance Factory Parts.

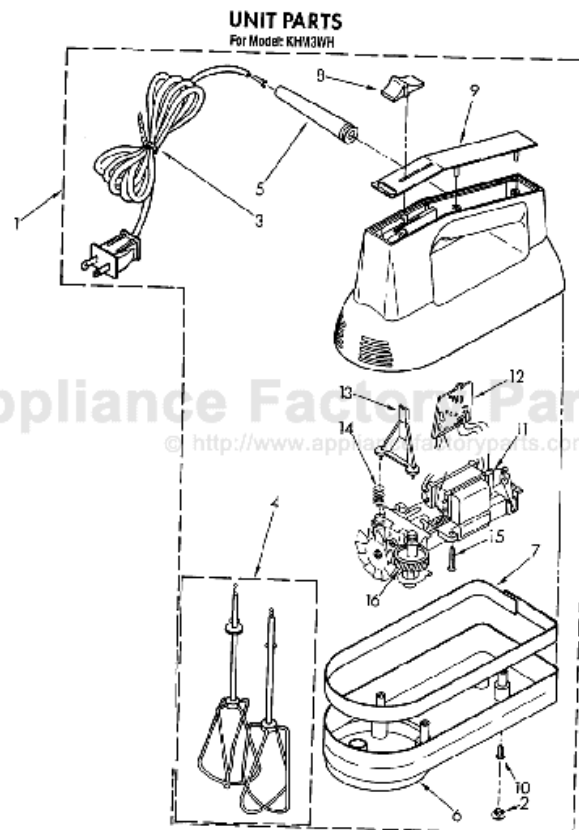

KITCHENAID KHM3WH5 Owner's Manual

[Shop genuine replacement parts for KITCHENAID
KHM3WH5](#)



[Find Your KITCHENAID Mixer Parts - Select From 532 Models](#)

----- Manual continues below -----

KitchenAid®

3 & 5 SPEED HAND MIXERS

INSTRUCTIONS AND RECIPES
www.KitchenAid.com



1-800-541-6390
Details Inside



FOR THE WAY IT'S MADE.™

Hassle-Free Replacement Warranty



We're so confident the quality of our products meets the exacting standards of KitchenAid that, if your mixer should fail within the first year of ownership, KitchenAid will arrange to deliver an identical or comparable replacement to your door free of charge and arrange to have your "failed" mixer returned to us. Your replacement unit will also be covered by our one year full warranty. Please follow these instructions to receive this quality service.

If you reside in the 50 United States and your KitchenAid® mixer should fail within the first year of ownership, simply call our toll-free Customer Satisfaction Center at **1-800-541-6390**, 8 a.m. to 8 p.m., Monday through Friday, 10 a.m. to 5 p.m., Saturday, Eastern Time. Give the consultant your complete shipping address. (No P.O. Box Numbers, please.)

When you receive your replacement mixer, use the carton and packing materials to pack-up your "failed" mixer. In the carton, include your name and address on a sheet of paper along with a copy of the proof of purchase (register receipt, credit card charge slip, etc.).

For a detailed explanation of warranty terms and conditions, including how to arrange for service outside the United States, see pages 3 and 4.

Proof of Purchase & Product Registration

Always keep a copy of the sales receipt showing the date of purchase of your mixer. Proof of purchase will assure you of in-warranty service.

Before you use your mixer, please fill out and mail your product registration card packed with the unit. This card will enable us to contact you in the unlikely event of a

product safety notification and assist us in complying with the provisions of the Consumer Product Safety Act. This card does not verify your warranty.

Please complete the following for your personal records:

Model Number _____

Serial Number _____

Date Purchased _____

Store Name _____

Table of Contents

Hassle-Free Replacement Warranty.....	Inside Front Cover
Product Registration Card	Inside Front Cover
Important Safeguards.....	2
Warranty	3
For the 50 United States and District of Columbia.....	3
For Puerto Rico	4
Arranging for Service after the Warranty Expires	4
Arranging for Service Outside the 50 United States and Puerto Rico	4
Ordering Accessories and Replacement Parts	4
Electrical Requirements.....	5
Troubleshooting Problems	5
Mixer Features	6
How to Use the Mixer	8
To Attach TurboBeater™ Accessories	8
To Remove TurboBeater™ Accessories.....	8
To Operate the Speed Control.....	9
Speed Control Guide for 3-Speed Mixer	10
Speed Control Guide for 5-Speed Mixer	10
Accessories for your KitchenAid® Hand Mixer.....	11
Care and Cleaning	11
Recipes	12

Your safety and the safety of others are very important.

We have provided many important safety messages in this manual and on your appliance. Always read and obey all safety messages.



This is the safety alert symbol.

This symbol alerts you to potential hazards that can kill or hurt you and others.

All safety messages will follow the safety alert symbol and either the word "DANGER" or "WARNING." These words mean:



You can be killed or seriously injured if you don't immediately follow instructions.



You can be killed or seriously injured if you don't follow instructions.

All safety messages will tell you what the potential hazard is, tell you how to reduce the chance of injury, and tell you what can happen if the instructions are not followed.

IMPORTANT SAFEGUARDS

When using electrical appliances, basic safety precautions should always be followed including the following:

1. Read all instructions.
2. To protect against risk of electrical shock, do not put mixer in water or other liquid.
3. Close supervision is necessary when this or any appliance is used near children.
4. Unplug mixer from outlet when not in use, before putting on or taking off parts, and before cleaning.
5. Avoid contacting moving parts. Keep hands, hair, clothing, as well as spatulas and other utensils away from all accessories during operation to reduce the risk of injury to persons and/or damage to the mixer.
6. Do not operate the mixer with a damaged cord or plug or after the mixer malfunctions, or is dropped or damaged in any manner. Return the mixer to the nearest Authorized Service Center for examination, repair or electrical or mechanical adjustment.
7. The use of attachments not recommended or sold by KitchenAid may cause fire, electric shock or injury.
8. Do not use the mixer outdoors.
9. Do not let the cord hang over the edge of table or counter.
10. Do not let cord contact hot surface, including the stove.
11. Remove any accessories from mixer before washing.
12. This product is designed for household use only..

SAVE THESE INSTRUCTIONS

KitchenAid® Hand Mixer Warranty for the 50 United States and District of Columbia

This warranty extends to the purchaser and any succeeding owner for mixers operated in the 50 United States and District of Columbia.

Length of Warranty:	KitchenAid Will Pay For Your Choice of:	KitchenAid Will Not Pay For:
<p>One Year Full Warranty from date of purchase.</p>	 <p>Hassle-Free Replacement of your mixer. See inside front cover for details on how to arrange for service, or call the Customer Satisfaction Center toll-free at 1-800-541-6390. OR The replacement parts and repair labor costs to correct defects in materials and workmanship. Service must be provided by an Authorized KitchenAid Service Center. See the KitchenAid® mixer Warranty for Puerto Rico on page 4 for details on how to arrange for service.</p>	<p>A. Repairs when mixer is used in other than normal single family home use. B. Damage resulting from accident, alteration, misuse or abuse. C. Any shipping or handling costs to deliver your mixer to an Authorized Service Center. D. Replacement parts or repair labor costs for mixers operated outside the 50 United States and District of Columbia.</p>

KITCHENAID DOES NOT ASSUME ANY RESPONSIBILITY FOR INCIDENTAL OR CONSEQUENTIAL DAMAGES. Some states do not allow the exclusion or limitation of incidental or consequential damages, so this exclusion may not apply to you. This warranty gives you specific legal rights and you may also have other rights which vary from state to state.

KitchenAid® Hand Mixer Warranty for Puerto Rico

A limited one year warranty extends to the purchaser and any succeeding owner for mixers operated in Puerto Rico. During the warranty period, all service **must** be handled by an Authorized KitchenAid Service Center. Please bring the mixer, or ship it

prepaid and insured, to the nearest Authorized Service Center. Call toll-free **1-800-541-6390** to learn the location of a Service Center near you. Your repaired mixer will be returned to you prepaid and insured.

Arranging for Service after the Warranty Expires

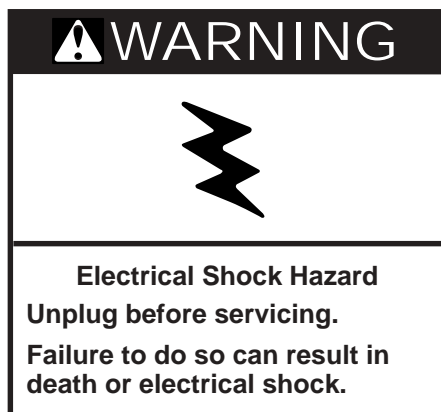

For service information, call toll-free 1-800-541-6390 or write to:
Customer Satisfaction Center,
KitchenAid Portable Appliances, P.O.
Box 218, St. Joseph, MI 49085-0218.

Arranging for Service Outside the 50 United States and Puerto Rico

Consult your local KitchenAid dealer or the store where you purchased the

hand mixer for information on how to obtain service.

Ordering Accessories and Replacement Parts

To order accessories or replacement parts for your mixer, call toll-free 1-800-541-6390 or write to:

Customer Satisfaction Center,
KitchenAid Portable Appliances, P.O.
Box 218, St. Joseph, MI 49085-0218.

Electrical Requirements

Volts: 120 A.C. only. Hertz: 60

NOTE: This mixer has a polarized plug (one blade is wider than the other). To reduce the risk of electric shock, this plug will fit in a polarized outlet only one way. If the plug does not fit fully in the outlet, reverse the plug. If it still does not fit, contact a qualified electrician. Do not modify the plug in any way.



Troubleshooting Problems

If your mixer should malfunction or fail to operate, check the following:

1. Is the mixer plugged in?
2. Is the fuse in the circuit to the mixer in working order? If you have a circuit breaker box, make sure the circuit is closed.
3. Try unplugging the mixer, then plug it back in.

If the problem cannot be corrected with the above steps, see the KitchenAid Warranty on page 3. Do not return the mixer to the retailer – they do not provide service.

KHM3, KHM5TB & KHM5DH Hand Mixer Features

The KitchenAid® Classic 3-Speed, Classic Plus 5-Speed and Ultra Power® 5-Speed Hand Mixers offer a host of conveniences, including a powerful yet lightweight motor, intuitive speed control, and easy-to-clean design. An electronic sensor automatically adjusts the mixer power to maintain a steady beater speed when the firmness of your mix changes.

The TurboBeater™ Accessories that come with your mixer have an open shape with no center post: this design permits thorough mixing with no clogging, little splashing, and minimal food collection.

Your mixer is designed to mix cookie doughs and cake batters, mash potatoes, and whip heavy cream and egg whites. With the optional dough hooks and liquid blender rod, the mixer can also knead yeast bread doughs and blend smoothies, milkshakes, soups, and sauces.

The KitchenAid® Hand Mixer is designed to deliver the same legendary quality and reliability that have been built into KitchenAid® Stand Mixers since 1919.

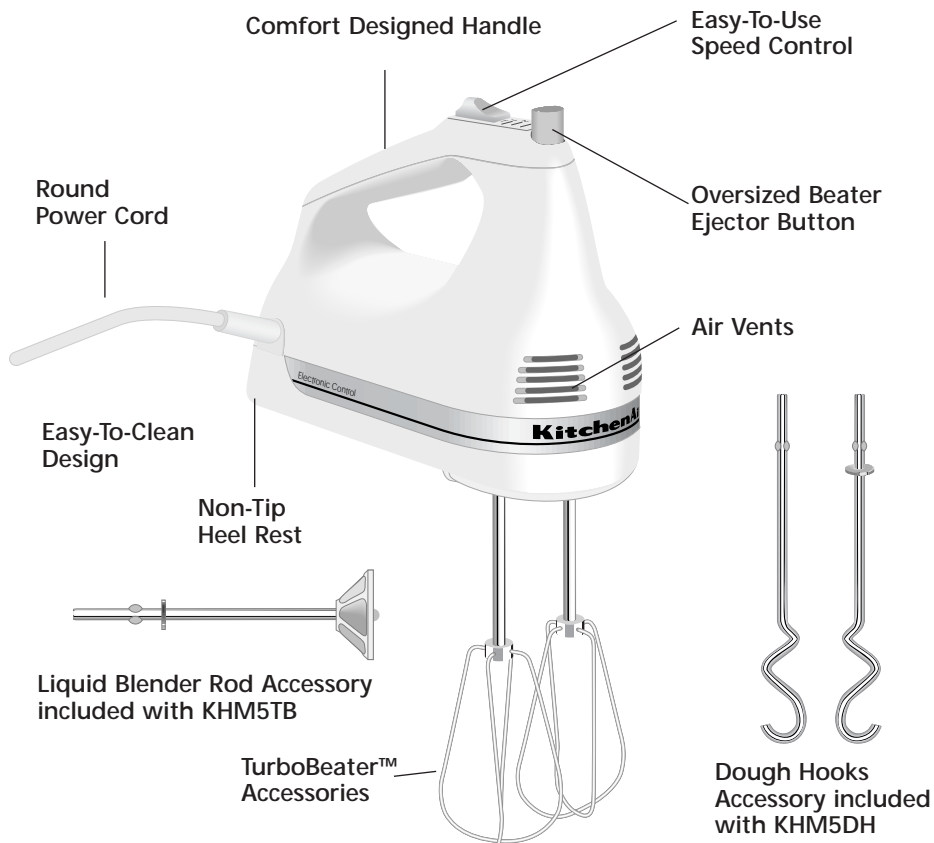

KHM3, KHM5TB & KHM5DH

Hand Mixer Features

Easy-To-Use Speed Control

Features a positive “click” at each speed setting.

Comfort Designed Handle

Angled handle reduces arm fatigue; rounded grip provides a comfortable fit for hands of all sizes.

Easy-To-Clean Design

Smooth styling has no ingredient-trapping cracks or crevices. Makes cleanup easy.

Oversized Beater Ejection Button

Makes for easy, single-handed ejection of beaters.

Round Power Cord

Round shape will not trap ingredients. Makes cleanup easy.

Non-Tip Heel Rest

Holds mixer stable when not in use.

Air Vents

Positioned to prevent clogging from batters and other mixtures.

TurboBeater™ Accessories

Self-cleaning mixing action. Dishwasher-safe, high quality stainless steel.

Liquid Blender Rod

Designed to mix smoothies, diet drink mixes, chocolate milk, milkshakes, ice tea, soups, and sauces. Mixes from 8 to 32 ounces of liquid. Included with model KHM5TB.

Dough Hooks

High-quality stainless steel designed to mix and knead yeast doughs. Included with model KHM5DH.

KitchenAid Quality

Your mixer is built and tested to meet KitchenAid standards for optimum performance and durability.

How to Use the Mixer

Be sure to read and follow the specific instructions in this manual for proper use of this mixer.

WARNING

Injury Hazard

Unplug mixer before touching beaters.

Failure to do so can result in broken bones, cuts or bruises.

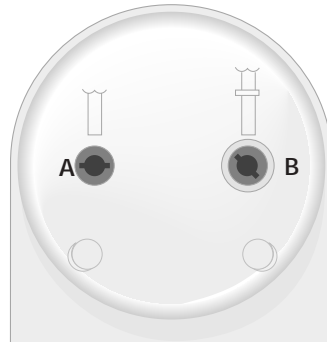

To Attach Accessories

1. Make sure the Speed Control is in the "OFF" position.
2. Unplug the mixer from the electrical outlet.
3. Each pair of accessories (TurboBeaters, optional Dough Hooks included with Model KHM5DH) will have one accessory with a collar (D), and one without (C). The hand mixer has a specific opening for each. Single accessories, like the optional Pro Whisk or Liquid Blender Rod (included with Model KHM5TB), will always have a collar (D).

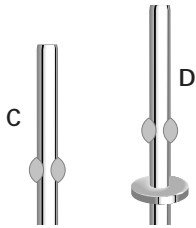

4. Insert the accessory with a collar (D) into the larger opening (B) of the hand mixer. Line up the flanges on the accessory with the slots in the opening and push in until it locks into place.

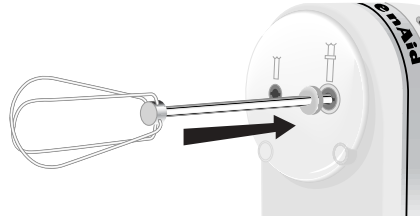

5. Insert the accessory without a collar (C) into the smaller opening (A) of the hand mixer. Line up the flanges on the accessory with the slots in the opening and push in until it locks into place.



To Remove Accessories

1. Make sure the Speed Control is in the "OFF" position.
2. Unplug the mixer from the electrical outlet.
3. Press the Ejector Button (E) to release the accessories from the mixer, then remove them.

To Operate the Speed Control



NOTE: When plugged in, an accidental touching of the Speed Control, or other circumstances, may result in the mixer starting unexpectedly.

1. Make certain the Speed Control is in the "OFF" position by sliding it backward as far as possible. "OFF/O" will be visible on the speed control pad when the switch is in the "OFF" position.
2. Plug the mixer into an electrical outlet.
3. Always start mixing at the lowest speed by sliding the Speed Control forward to the first position mark, which is Speed 1.
4. To increase the mixer speed, slide the Speed Control forward. To decrease the mixer speed, slide the Speed Control backward.
5. When the mixing job is finished, shut off the mixer by sliding the Speed Control backward as far as possible. Unplug the mixer before removing the accessories.

Speed Control Guide for 3-Speed Mixer



The Classic 3-Speed Hand Mixer should always be set on the lowest speed to start mixing. Move to higher speeds as needed.

Speed 1 Start all mixing procedures. Combine cream cheese mixtures. Stir gelatin mixtures. Mash potatoes.

Stir in nuts, chocolate chips, shredded cheese, onions, olives, and other chunky ingredients. Mix flour and other dry ingredients with liquids or other moist mixtures. Helps prevent ingredients from splashing out of bowl.

Speed 2 Mix muffins, quick breads, cake batters, and frostings. Mash potatoes or squash. Blend butter and sugar. Combine heavy mixtures, such as cookie dough.

Speed 3 Whip heavy cream and mousse mixtures. Beat egg whites and meringue mixtures.

NOTE: The TurboBeater™ Accessories are not designed for mixing and kneading bread dough. Special dough hook attachments are available. See "Accessories for Your KitchenAid® Hand Mixer" (page 11) for details and ordering information.

Speed Control Guide for 5-Speed Mixer



The Classic Plus 5-Speed and Ultra Power® 5-Speed Hand Mixer should always be set on the lowest speed to start mixing. Move to higher speeds as needed.

Speed 1 For slow stirring, combining, and starting all mixing procedures. Use this

speed to stir in nuts, chocolate chips, shredded cheese, onions, olives, and other chunky ingredients. Mix flour and other dry ingredients with liquids or other moist mixtures. Helps prevent ingredients from splashing out of bowl.

Speed 2 Stir batters and gelatin mixtures. Combine heavy mixtures, such as cookie dough. Mix light cream cheese spreads. Mash potatoes.

Speed 3 Combine heavy cream cheese mixtures. Mash squash.

Speed 4 Blend butter and sugar. Mix muffins, quick breads, cake batters, and frostings.

Speed 5 Beat egg whites and meringue mixtures. Whip heavy cream and mousse mixtures.

NOTE: The TurboBeater™ Accessories are not designed for mixing and kneading bread dough. Special dough hook attachments are available. See "Accessories for Your KitchenAid® Hand Mixer" (page 11) for details and ordering information.

Accessories for your KitchenAid® Hand Mixer

Liquid Blender Rod

A great way to mix up smoothies, diet drink mixes, chocolate milk, ice tea, and milkshakes. Also invaluable for soups and sauces that require light blending. The 8½ inch long Liquid Blender Rod attaches to the mixer like a regular beater (see page 8) and can mix from 8 to 32 ounces of liquid. Hand wash with mild detergent.

Dough Hooks

A must-have attachment for the bread baker! The stainless steel Dough Hooks enable your mixer to knead yeast bread doughs, saving you untold time and effort. The Dough Hooks attach to the mixer like regular beaters (see page 8) and are dishwasher safe for quick clean-up.

Pro Whisk

Designed to produce fluffier whipped cream and egg whites, the stainless steel Pro Whisk will also ensure smooth sauces and puddings. The Pro Whisk attaches to the mixer like a regular beater (see page 8) and is dishwasher safe for easy clean-up.

To order these accessories, visit www.KitchenAid.com, or call 1-800-541-6390.

Care and Cleaning

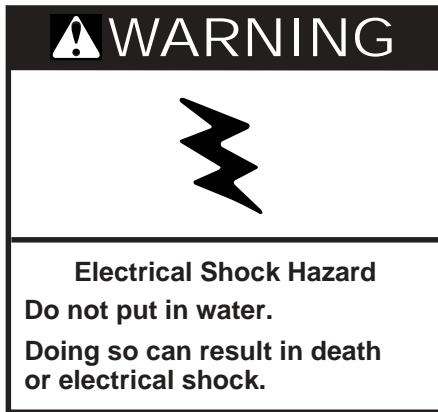

Always unplug mixer before cleaning. Do not immerse mixer in water. Wipe mixer with a warm, sudsy cloth; then wipe clean with a damp cloth. Dry with a soft cloth.

TurboBeater™ Accessories, Pro Whisk*, Dough Hooks*

Always remove accessories from mixer before cleaning. Wash in dishwasher, or by hand in warm, sudsy water. Rinse and wipe dry.

Liquid Blender Rod*

Always remove blender rod from mixer before cleaning. Hand wash in warm, sudsy water. Rinse, and wipe dry.

Power Cord

Wipe cord with a warm, sudsy cloth; then wipe clean with a damp cloth. Dry with a soft cloth.

*These accessories are not included with all hand mixer models; see "Accessories for Your KitchenAid® Hand Mixer" for details and ordering information.

Raspberry Cream Cheese Spread

- 1 package (8 oz.) light cream cheese
3 tablespoons seedless raspberry preserves
¼ teaspoon grated orange peel
- Place all ingredients in small bowl. Beat on Speed 1 about 1 minute, or until smooth and creamy, scraping bowl once or twice. Serve with mini-bagels or crackers, if desired.
- Yield: 10 servings (2 tablespoons per serving).
Per serving: About 64 cal, 2 g pro, 6 g carb, 4 g total fat, 2 g sat fat, 8 mg chol, 128 mg sod.

Honey-Walnut Cream Cheese Spread

- 1 package (8 oz.) light cream cheese
2 tablespoons honey
¼ cup chopped walnuts
- Place cream cheese and honey in small bowl. Beat on Speed 1 about 1 minute, or until smooth and creamy, scraping bowl once or twice. Add walnuts. Beat on Speed 1 about 20 seconds, or until combined. Serve with mini-bagels or crackers, if desired.
- Yield: 10 servings (2 tablespoons per serving).
Per serving: About 80 cal, 3 g pro, 5 g carb, 6 g total fat, 3 g sat fat, 8 mg chol, 128 mg sod.

Dilled Salmon Mousse

- 2 envelopes unflavored gelatin
¾ cup water
½ cup reduced-calorie mayonnaise
1 cup nonfat plain yogurt
2-3 tablespoons chopped fresh dill
1 tablespoon lemon juice
¼ teaspoon salt
½ teaspoon black pepper
Dash cayenne pepper
1 can (14½ oz.) red salmon, drained and flaked
- Spray 1-quart mold with no-stick cooking spray. In small saucepan, sprinkle gelatin over water. Let stand 5 minutes until softened. Heat over low heat, stirring until gelatin is dissolved. Cool slightly.
- Place mayonnaise and gelatin mixture in medium bowl. Beat on Speed 1 about 30 seconds, or until smooth. Add remaining ingredients, except salmon. Beat on Speed 1 for 30 to 60 seconds, or until smooth. Stir in salmon. Pour into mold. Refrigerate at least 4 hours, or until firm. Remove mousse from mold. Serve with crackers or cocktail breads, if desired.
- Yield: 16 servings (¼ cup per serving).
Per serving: About 72 cal, 7 g pro, 2 g carb, 4 g total fat, 1 g sat fat, 11 mg chol, 243 mg sod.

Beer Cheese Bread

<i>2½-3½ cups all-purpose flour</i>	Attach dough hooks to mixer. Combine 2 cups flour, yeast, sugar, and salt in large bowl. Set aside.
<i>1 package active dry yeast</i>	Place beer and margarine in small saucepan. Heat over medium heat until margarine melts. Continue heating to 120°F to 130°F. Add to flour mixture.
<i>2 tablespoons sugar</i>	Beat on Speed 3 about 1 minute, or until blended.
<i>1 teaspoon salt</i>	Add egg and hot pepper sauce. Beat on Speed 3 about 20 seconds, or until combined.
<i>1 cup beer</i>	Continuing on Speed 3, add cheese and remaining flour, ¼ cup at a time, until dough cleans sides of bowl, scraping sides of bowl. Knead on Speed 3 about 2 minutes, or until dough is smooth and elastic. Dough will be slightly sticky to the touch.
<i>2 tablespoons margarine or butter</i>	Place dough in greased bowl, turning to grease top. Cover. Let rise in warm place, free from draft, about 1 hour, or until doubled in bulk.
<i>1 egg</i>	Punch dough down. With lightly oiled hands, shape dough into 9x5-inch loaf. Place in greased
<i>½ teaspoon hot pepper sauce</i>	9x5x3-inch baking pan. Cover. Let rise in warm place, free from draft, about 1 hour, or until doubled in bulk.
<i>1½ cups shredded reduced-fat sharp Cheddar cheese</i>	Bake at 375°F for 30 to 40 minutes, or until golden brown. Remove from pan immediately and cool on wire rack. Serve warm.
	Yield: 16 servings.
	Per serving: About 132 cal, 6 g pro, 18 g carb, 4 g total fat, 2 g sat fat, 21 mg chol, 248 mg sod.

Basic White Bread

- 1 cup lowfat milk
- 1 tablespoon sugar
- 1 teaspoon salt
- 2 tablespoons margarine or butter
- 1 package active dry yeast
- 2-3½ cups all-purpose flour

Attach dough hooks to mixer. Combine 2 cups flour and yeast in large bowl. Set aside.

Place milk, sugar, salt, and margarine in small saucepan. Heat over medium heat until margarine melts and sugar dissolves, stirring frequently. Continue heating to 120°F to 130°F. Add to flour mixture. Beat at Speed 3 about 1 minute, or until blended.

Continuing on Speed 3, add remaining flour, ¼ cup at a time, until dough cleans sides of bowl, scraping sides of bowl. Knead on Speed 3 about 2 minutes, or until dough is smooth and elastic. Dough will be slightly sticky to the touch.

Place dough in greased bowl, turning to grease top. Cover. Let rise in warm place, free from draft, about 1 hour, or until doubled in bulk.

Punch dough down. With lightly oiled hands, shape dough into 8x4-inch loaf. Place in greased 8½x4½x2½-inch baking pan. Cover. Let rise in warm place, free from draft, about 1 hour, or until doubled in bulk.

Bake at 400°F for 30 to 40 minutes, or until golden brown. Remove from pan immediately and cool on wire rack.

Yield: 16 servings.

Per serving: About 81 cal, 2 g pro, 14 g carb, 2 g total fat, 0 g sat fat, 1 mg chol, 168 mg sod.

Mashed Potatoes

2 pounds (about 6 medium) russet potatoes, peeled, cut into quarters, and boiled

$\frac{1}{4}$ cup margarine or butter, softened

$\frac{1}{2}$ teaspoon salt

$\frac{1}{8}$ teaspoon black pepper

$\frac{1}{4}$ - $\frac{1}{2}$ cup lowfat milk, warmed

Drain potatoes well. Return to hot saucepan. Add margarine, salt, and pepper. Beat on Speed 1 about 20 seconds, or until potatoes are broken up. Continuing on Speed 1, slowly add milk. Beat about 45 seconds, or until smooth. Serve immediately.

Yield: 8 servings (about $\frac{1}{2}$ cup per serving).

Per serving: About 137 cal, 3 g pro, 19 g carb, 6 g total fat, 1 g sat fat, 0 mg chol, 221 mg sod.

VARIATIONS

Garlic Mashed Potatoes

Add 6 to 8 large, peeled cloves garlic to potatoes before boiling.

Yield: 8 servings (about $\frac{1}{2}$ cup per serving).

Per serving: About 140 cal, 3 g pro, 20 g carb, 6 g total fat, 1 g sat fat, 0 mg chol, 222 mg sod.

Carrot and Leek Mashed Potatoes

Add 2 medium carrots, cut into 1-inch pieces, and 1 medium leek, cut into 1-inch pieces, to potatoes before boiling. Cook until tender.

Yield: 10 to 12 servings (about $\frac{1}{2}$ cup per serving).

Per serving: About 154 cal, 3 g pro, 23 g carb, 6 g total fat, 1 g sat fat, 0 mg chol, 231 mg sod.

Pesto Mashed Potatoes

Prepare potatoes as directed. Add $\frac{1}{4}$ cup prepared pesto. Beat on Speed 1 about 15 seconds, or until blended.

Yield: 8 servings (about $\frac{1}{2}$ cup per serving).

Per serving: About 176 cal, 4 g pro, 20 g carb, 10 g total fat, 2 g sat fat, 1 mg chol, 276 mg sod.

Squash and Apple Bake

- 1 *cup reduced-sodium chicken broth*
1/4 *teaspoon cloves*
2 *acorn squash (about 3½ lbs.), washed, cut into halves, and seeds removed*
2 *teaspoons margarine or butter*
1 *medium onion, chopped*
1 *medium apple, peeled, cored, and chopped*
2 *tablespoons fat-free egg substitute*
1/4 *cup seasoned bread crumbs*
2 *teaspoons margarine or butter*

Spray 1-quart casserole dish with no-stick cooking spray.

Place broth and cloves in large skillet or Dutch oven. Add squash, cut side down. Bring to a boil. Reduce heat to medium-low. Cook, covered, 15 to 25 minutes, or until squash is soft. Remove squash; cool slightly. Scoop out pulp. Set aside.

Meanwhile, melt 2 teaspoons margarine in nonstick skillet over medium heat. Add onion. Cook and stir about 1 minute. Add apple. Cook and stir 3 to 4 minutes longer, or until onion is tender.

Place squash in large bowl. Beat on Speed 3 for 15 to 20 seconds, or until broken up. Add egg substitute. Beat on Speed 3 about 30 seconds, or until smooth. Add onion mixture. Beat on Speed 1 about 15 seconds, or until combined. Spoon squash mixture into casserole dish.

Combine bread crumbs and 2 teaspoons melted margarine in small bowl. Beat on Speed 1 about 15 seconds, or until blended. Sprinkle evenly over squash. Bake at 350°F for 25 to 35 minutes, or until thoroughly heated.

Yield: 6 to 8 servings (about 1/2 cup per serving).

Per serving: About 124 cal, 3 g pro, 24 g carb, 3 g total fat, 1 g sat fat, 2 mg chol, 260 mg sod.

Savory Sweet Potatoes

- 2 pounds sweet potatoes (about 3 medium), scrubbed, unpeeled, and boiled
- $\frac{1}{8}$ cup thinly sliced green onions
- $\frac{1}{2}$ teaspoon dried marjoram leaves
- Dash cayenne pepper
- $\frac{1}{8}$ cup reduced-sodium chicken broth
- $\frac{1}{2}$ cup nonfat sour cream

Drain potatoes well; cool slightly. Cut ends from potatoes. Slip off and discard peels.

Place potatoes, onions, marjoram, and pepper in large bowl. Beat on Speed 1 about 10 seconds, or until potatoes are broken up. Add broth. Beat on Speed 3 about 30 seconds, or until smooth. Add sour cream. Beat on Speed 1 about 20 seconds, or until blended. Serve immediately.

Yield: 8 servings (about $\frac{1}{2}$ cup per serving).

Per serving: About 166 cal, 4 g pro, 36 g carb, 1 g total fat, 0 g sat fat, 0 mg chol, 50 mg sod.

Overnight Sausage and Egg Brunch

- 1 pound turkey Italian sausage links, cut into $\frac{1}{4}$ -inch thick slices
- 1 medium onion, chopped
- 1 package (8 oz.) light cream cheese
- 1 teaspoon dried marjoram leaves
- $\frac{1}{2}$ teaspoon salt
- $\frac{1}{4}$ teaspoon cayenne pepper
- 1 cup fat-free egg substitute
- 1 can (12 oz.) evaporated skimmed milk
- 9 slices French bread, sliced diagonally 1-inch thick
- 1 package (16 oz.) frozen chopped broccoli, thawed*
- 1 cup shredded reduced-fat sharp Cheddar cheese

Spray 13x9x2-inch baking dish with no-stick cooking spray.

Place sausage and onion in medium nonstick skillet. Cook over medium heat about 8 minutes, or until sausage is no longer pink in center and onion is tender. Set aside.

Place cream cheese, marjoram, salt, and pepper in medium bowl. Beat on Speed 1 about 20 seconds, or until smooth. Add egg substitute and milk. Beat on Speed 2 about 20 seconds, or until smooth.

Layer bread in baking dish. Top with sausage mixture, broccoli, and Cheddar cheese. Pour cream cheese mixture evenly over top. Cover tightly. Refrigerate at least 8 hours or overnight.

Uncover dish. Bake at 350°F for 1 hour 15 minutes, or until knife inserted in center comes out clean.

Yield: 12 servings.

Per serving: About 264 cal, 18 g pro, 17 g carb, 14 g total fat, 5 g sat fat, 55 mg chol, 728 mg sod.

Tip: Rinse broccoli under hot water to thaw. Drain well.

Cheese and Salsa Crostini

- 2 *egg whites*
- $\frac{1}{4}$ *cup finely chopped green onions*
- $\frac{1}{4}$ *cup chopped ripe olives*
- $\frac{1}{4}$ *cup shredded reduced-fat sharp Cheddar cheese*
- $\frac{1}{4}$ *cup shredded reduced-fat Monterey Jack cheese*
- 4 *slices pumpernickel bread, crusts removed*
- $\frac{1}{8}$ *cup thick and chunky salsa*
- Place egg whites in medium bowl. Beat on Speed 3 for 1 to 1½ minutes, or until stiff peaks form. Add onions, olives, and cheeses. Beat on Speed 1 for 10 to 20 seconds, or until combined.
- Spread mixture on bread slices. Place on ungreased baking sheet. Bake at 350°F for 15 to 20 minutes, or until puffed and golden brown. Cut each slice into quarters. Top each quarter with about 1 teaspoon salsa.
- Yield: 8 servings (2 crostini per serving).
- Per serving: About 39 cal, 2 g pro, 4 g carb, 1 g total fat, 0 g sat fat, 3 mg chol, 203 mg sod.

Skillet Chicken Florentine

- 2 *medium shallots, chopped*
- 4 *ounces light cream cheese*
- $\frac{1}{4}$ *cup seasoned bread crumbs*
Dash nutmeg
- 1 *package (9 oz.) frozen chopped spinach, thawed and pressed dry*
- 4 *boneless, skinless chicken breast halves, pounded slightly to flatten*
- $\frac{1}{2}$ *cup shredded reduced-fat Swiss cheese*
- 1 *can (14 $\frac{1}{2}$ oz.) diced tomatoes with roasted garlic, onion, and oregano*

Spray large nonstick skillet with no-stick cooking spray. Heat over medium heat. Add shallots. Cook about 5 minutes, or until tender. Add 2 tablespoons water, if necessary, to prevent browning.

Place cream cheese, shallots, bread crumbs, and nutmeg in medium bowl. Beat on Speed 1 about 30 seconds, or until blended. Break apart spinach with fork. Add to cream cheese mixture. Beat on Speed 1 about 15 seconds, or until blended.

Spread one-fourth of mixture on each chicken breast. Fold chicken breast over to enclose filling. Spray large nonstick skillet with no-stick cooking spray. Heat over medium-high heat. Add chicken. Cook about 3 minutes, or until evenly browned. Add tomatoes. Reduce heat to low. Cook, covered, 8 to 12 minutes, or until chicken is thoroughly cooked and filling is hot. To serve, spoon tomatoes over chicken.

Yield: 4 servings.

Per serving: About 306 cal, 39 g pro, 16 g carb, 11 g total fat, 4 g sat fat, 90 mg chol, 873 mg sod.

Apple Waffles

- 2 *eggs, separated*
- 3 *tablespoons margarine or butter, melted*
- 1 *cup lowfat milk*
- $1\frac{3}{4}$ *cups all-purpose flour*
- 1 *tablespoon baking powder*
- $\frac{1}{2}$ *teaspoon cinnamon*
- 1 *cup shredded apple*

Place egg whites in small bowl. Beat on Speed 3 about 40 seconds, or until stiff peaks form. Set aside.

Place egg yolks, margarine, and milk in medium bowl. Beat on Speed 1 about 20 seconds, or until blended. Add flour, baking powder, and cinnamon. Beat on Speed 1 about 30 seconds, or until blended. Beat on Speed 2 about 20 seconds, or until smooth. Add apple. Beat on Speed 1 about 15 seconds, or until combined. Add egg whites. Beat on Speed 1 about 15 seconds, or until blended.

Spray waffle iron with no-stick cooking spray. Heat according to manufacturer's directions. Pour about $\frac{1}{3}$ cup batter for each waffle onto iron. Bake until steaming stops and waffles are golden brown.

Yield: 6 servings (1 waffle per serving).

Per serving: About 242 cal, 7 g pro, 34 g carb, 9 g total fat, 2 g sat fat, 75 mg chol, 239 mg sod.

Peach Coffeecake

<i>1 medium ripe peach, peeled and chopped</i>	Spray 8x8x2-inch baking dish with no-stick cooking spray.
<i>½ cup reduced-fat sour cream</i>	Place chopped peach in small bowl. Mash with fork.
<i>¼ cup margarine or butter, softened</i>	Add sour cream. Beat on Speed 1 about 1 minute, or until well mixed.
<i>½ cup sugar, divided</i>	Place margarine and sugar, reserving 1 tablespoon, in medium bowl. Beat on Speed 3 about 1 minute, or until fluffy. Add egg substitute. Beat on Speed 3 about 20 seconds, or until smooth. Add peach mixture, reserving ½ cup. Beat on Speed 3 about 30 seconds, or until smooth. Add flour, baking powder, baking soda, and salt. Beat on Speed 1 about 30 seconds, or until blended. Beat on Speed 3 for 30 to 60 seconds, or just until smooth.
<i>¼ cup fat-free egg substitute</i>	
<i>1 cup all-purpose flour</i>	
<i>½ teaspoon baking powder</i>	
<i>½ teaspoon baking soda</i>	
<i>¼ teaspoon salt</i>	
<i>1 peach, peeled and sliced</i>	Pour batter into baking dish. Drizzle with reserved ½ cup peach mixture. Top with peach slices. Sprinkle with reserved 1 tablespoon sugar. Bake at 350°F for 30 to 35 minutes, or until wooden pick inserted in center comes out clean. Cool slightly. Serve warm.
	Yield: 9 servings.
	Per serving: About 169 cal, 3 g pro, 26 g carb, 6 g total fat, 1 g sat fat, 4 mg chol, 227 mg sod.

Chocolate Chip Cookies

<i>1 cup sugar</i>	Place sugar, brown sugar, margarine, eggs, and vanilla in large bowl. Beat on Speed 1 for 1 to 1½ minutes, or until smooth.
<i>1 cup firmly packed brown sugar</i>	
<i>1 cup margarine or butter, softened</i>	Add flour, baking soda, and salt. Beat on Speed 1 about 30 seconds, or until blended. Beat on Speed 2 for 30 to 60 seconds, or until smooth. Add chocolate chips. Beat on Speed 1 about 15 seconds, or until combined.
<i>2 eggs</i>	
<i>1½ teaspoons vanilla</i>	
<i>3 cups all-purpose flour</i>	
<i>1 teaspoon baking soda</i>	Drop by rounded teaspoonfuls onto ungreased baking sheets, about 2 inches apart. Bake at 375°F for 10 to 12 minutes. Remove from baking sheets immediately and cool on wire racks.
<i>¼ teaspoon salt</i>	
<i>12 ounces semi-sweet chocolate chips</i>	Yield: 54 servings (1 cookie per serving).
	Per serving: About 117 cal, 1 g pro, 17 g carb, 5 g total fat, 1 g sat fat, 8 mg chol, 76 mg sod.

Whipped Cream

1 cup heavy cream
2 tablespoons powdered sugar
½ teaspoon vanilla

Place cream in medium bowl. Beat on Speed 3 about 30 seconds, or until soft peaks form. Continuing on Speed 3, gradually add powdered sugar and vanilla. Beat about 30 seconds, or until stiff.

Yield: 16 servings (2 tablespoons per serving).

Per serving: About 48 cal, 0 g pro, 1 g carb, 5 g total fat, 3 g sat fat, 17 mg chol, 5 mg sod.

VARIATIONS:

Amaretto Whipped Cream

Substitute 2 tablespoons amaretto liqueur for the vanilla.

Per serving: About 54 cal, 0 g pro, 2 g carb, 5 g total fat, 3 g sat fat, 17 mg chol, 6 mg sod.

Cappuccino Whipped Cream

Add 2 teaspoons instant coffee granules or crystals to cream before whipping. Increase powdered sugar to ¼ cup.

Per serving: About 52 cal, 0 g pro, 2 g carb, 5 g total fat, 3 g sat fat, 17 mg chol, 6 mg sod.

Spiced Whipped Cream

Add ¼ teaspoon cinnamon and ⅛ teaspoon nutmeg with powdered sugar.

Per serving: About 48 cal, 0 g pro, 1 g carb, 5 g total fat, 3 g sat fat, 17 mg chol, 5 mg sod.

Meringue Dessert Tarts

- 4 egg whites
- $\frac{1}{8}$ teaspoon cream of tartar
- $\frac{3}{4}$ cup sugar

Place egg whites in large bowl. Beat on Speed 3 about 30 seconds, or until frothy. Add cream of tartar. Beat on Speed 3 about 1 minute, or until soft peaks form. Continuing on Speed 3, add sugar, 1 tablespoon at a time, beating for 6 to 7 minutes, or until stiff and glossy.

Spoon or pipe meringue into eight $3\frac{1}{2}$ -inch circles on baking sheet lined with parchment paper or foil. Make indentation in center of each circle. Bake at 275°F for 35 minutes. Turn off oven and let meringues stand in oven 2 hours or overnight. Serve with Strawberry Yogurt Filling or Chocolate Mousse Filling.

Strawberry Yogurt Filling

- 1 package (8 oz.) light cream cheese
- $1\frac{1}{2}$ cups lowfat strawberry yogurt
- 3 tablespoons powdered sugar
- 2 cups sliced fresh strawberries

Place all ingredients in large bowl. Beat on Speed 2 about 1 minute, or until smooth and creamy. Refrigerate until serving time. To serve, spoon about $\frac{1}{4}$ cup filling into each Meringue Dessert Tart. Top with strawberries.

Chocolate Mousse Filling

- $\frac{3}{4}$ cup semi-sweet chocolate chips
- 3 tablespoons water
- $\frac{1}{4}$ teaspoon almond extract
- 1 cup heavy cream
- 2 tablespoons powdered sugar
- $\frac{1}{2}$ cup sliced almonds

Place chocolate chips and water in small saucepan. Heat over low heat until smooth and melted, stirring constantly. Stir in almond extract. Cool to room temperature, about 30 minutes.

Place cream in large bowl. Beat on Speed 3 about 30 seconds, or until soft peaks form. Continuing on Speed 3, gradually add powdered sugar. Beat about 30 seconds, or until stiff. Fold in chocolate with spatula until blended. Refrigerate until serving time.

To serve, spoon about $\frac{1}{4}$ cup filling into each Meringue Dessert Tart. Top with almonds.

Yield: 8 servings.

Per serving (tart and strawberry filling): About 205 cal, 7 g pro, 34 g carb, 6 g total fat, 3 g sat fat, 12 mg chol, 213 mg sod.

Per serving (tart and chocolate filling): About 285 cal, 5 g pro, 33 g carb, 17 g total fat, 6 g sat fat, 35 mg chol, 39 mg sod.

Lemon Pudding Cake

3 eggs, separated
 $\frac{3}{4}$ cup lowfat milk
 $\frac{1}{4}$ cup fresh lemon juice
1 teaspoon grated
lemon peel
1 cup sugar
 $\frac{3}{4}$ cup all-purpose flour
 $\frac{1}{4}$ teaspoon salt

Place egg whites in medium bowl. Beat on Speed 3 for 1 to 1½ minutes, or until stiff peaks form. Set aside.

Place egg yolks in large bowl. Beat on Speed 2 about 30 seconds. Add milk, lemon juice, and grated peel. Beat on Speed 2 about 30 seconds, or until combined. Add remaining ingredients. Beat on Speed 1 about 10 to 20 seconds, or until blended. Beat on Speed 2 about 1 minute, or until smooth and frothy. Fold in egg whites with spatula, just until combined.

Spoon batter into ungreased 1½-quart soufflé or casserole dish. Place dish in large, shallow baking pan. Add hot water to pan to 1-inch depth. Place in oven. Bake at 350°F for 35 to 45 minutes, or until golden brown. Cool slightly. Serve warm.

Yield: 6 servings.

Per serving: About 241 cal, 6 g pro, 48 g carb, 3 g total fat, 1 g sat fat, 109 mg chol, 143 mg sod.

Oatmeal-Nut Snack Cake

<i>1½ cups quick-cooking oats</i>	Grease and flour 13x9x2-inch baking pan. Combine oats and boiling water in medium bowl. Let stand 10 minutes.
<i>1¼ cups boiling water</i>	
<i>½ cup margarine or butter, softened</i>	Place margarine, brown sugar, and eggs in large bowl. Beat on Speed 1 about 30 seconds, or until blended. Beat on Speed 3 about 1 minute, or until smooth and creamy. Add flour, baking soda, baking powder, cinnamon, and salt. Beat on Speed 1 about 30 seconds, or until blended. Beat on Speed 3 about 1 minute, or until well mixed. Add oatmeal. Beat on Speed 1 about 30 seconds, or until combined. Add walnuts. Beat on Speed 1 about 10 seconds, or until combined.
<i>1½ cups firmly packed brown sugar</i>	
<i>2 eggs</i>	
<i>1½ cups all-purpose flour</i>	
<i>1 teaspoon baking soda</i>	
<i>½ teaspoon baking powder</i>	
<i>1 teaspoon cinnamon</i>	Spread batter in pan. Bake at 350°F for 30 to 35 minutes, or until toothpick inserted in center comes out clean. Cool completely. Frost with Maple Buttercream Frosting (below), if desired.
<i>¼ teaspoon salt</i>	
<i>½ cup chopped walnuts</i>	

Yield: 16 servings.

Per serving: About 235 cal, 4 g pro, 35 g carb, 9 g total fat, 2 g sat fat, 27 mg chol, 206 mg sod.

Buttercream Frosting

<i>¼ cup butter, softened</i>	Place all ingredients in large bowl. Beat on Speed 3 for 30 to 60 seconds, or until smooth and creamy.
<i>½ teaspoon vanilla</i>	
<i>2 tablespoons lowfat milk</i>	Yield: 16 servings (frosting for 13x9x2-inch cake).
<i>2 cups powdered sugar</i>	Per serving: About 75 cal, 0 g pro, 13 g carb, 3 g total fat, 2 g sat fat, 8 mg chol, 30 mg sod.

VARIATIONS

Maple Buttercream Frosting

Add ¼ teaspoon maple extract.

Yield: 16 servings (frosting for 13x9x2-inch cake).

Per serving: About 75 cal, 0 g pro, 13 g carb, 3 g total fat, 2 g sat fat, 8 mg chol, 30 mg sod.



FOR THE WAY IT'S MADE.™

® Registered Trademark/™ Trademark of KitchenAid, U.S.A.