

This Owner's Manual is provided and hosted by [Appliance Factory Parts](#).



KITCHENAID KSM90PSBU Owner's Manual

[Shop genuine replacement parts for KITCHENAID
KSM90PSBU](#)

COLOR VARIATION PARTS
FOR MODELS: KSM90PS__0

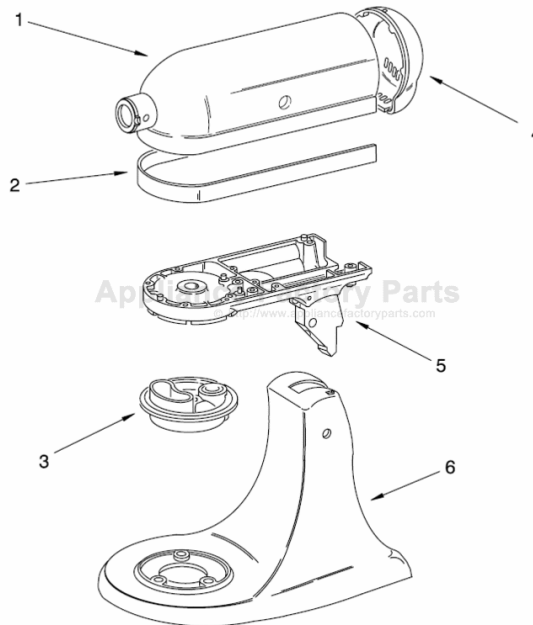

[Find Your KITCHENAID Mixer Parts - Select From 532 Models](#)

----- Manual continues below -----

**PIL to do
new cover**

HASSLE-FREE REPLACEMENT WARRANTY



We're so confident the quality of our products meets the exacting standards of KitchenAid that, if your Stand Mixer should fail within the first year of ownership, KitchenAid will arrange to deliver an identical or comparable replacement to your door free of charge and arrange to have your "failed" Stand Mixer returned to us. Your replacement unit will also be covered by our one year full warranty. Please follow these instructions to receive this quality service.

If you reside in the 50 United States and your KitchenAid® Stand Mixer should fail within the first year of ownership, simply call our toll-free Customer Satisfaction Center at **1-800-541-6390**, 8 a.m. to 8 p.m., Monday through Friday, 10 a.m. to 5 p.m., Saturday, Eastern Time. Give the consultant your complete shipping address. (No P.O. Box Numbers, please.)

When you receive your replacement Stand Mixer, use the carton and packing materials to pack-up your "failed" Stand Mixer. In the carton, include your name and address on a sheet of paper along with a copy of the proof of purchase (register receipt, credit card charge slip, etc.).

For a detailed explanation of warranty terms and conditions, including how to arrange for service outside the United States, see pages 4 and 5.

PROOF OF PURCHASE & PRODUCT REGISTRATION

Always keep a copy of the sales receipt showing the date of purchase of your Stand Mixer. Proof of purchase will assure you of in-warranty service.

Before you use your Stand Mixer, please fill out and mail your product registration card packed with the unit.

This card will enable us to contact you in the unlikely event of a product safety notification and assist us in complying with the provisions of the Consumer Product Safety Act. This card does not verify your warranty.

Please complete the following for your personal records:

Model Number _____

Serial Number _____

Date Purchased _____

Store Name _____

TABLE OF CONTENTS

Hassle-Free Replacement Warranty	Inside Front Cover
Product Registration Card	Inside Front Cover
Important Safeguards	3
Warranty.....	4
For the 50 United States and District of Columbia	4
For Puerto Rico.....	5
Arranging for Service after the Warranty Expires.....	5
Arranging for Service Outside the 50 United States & Puerto Rico	5
Ordering Accessories and Replacement Parts	5
Electrical Requirements.....	6
Troubleshooting Problems	7
About Your Mixer.....	8
Stand Mixer Features.....	8
Assembling Your Mixer.....	9
Using Your Pouring Shield	10
Using Your KitchenAid® Accessories.....	11
Mixing Time	11
Mixer Use.....	12
Care and Cleaning.....	12
Beater to Bowl Clearance	13
Speed Control Guide.....	14
Mixing Tips	15
Egg Whites	16
Whipped Cream	16
Attachments and Accessories - General Instructions	17
Appetizers, Entrees, and Vegetables	?
Cakes and Frostings.....	?
Cookies, Bars, and Candies.....	?
Pies and Desserts.....	?
Yeast Breads and Quick Breads	?
General Instructions for Mixing and Kneading Yeast Dough.....	?
Bread Making Tips.....	?
KitchenAid® Attachments and Accessories	?

Your safety and the safety of others are very important.

We have provided many important safety messages in this manual and on your appliance. Always read and obey all safety messages.



This is the safety alert symbol.

This symbol alerts you to potential hazards that can kill or hurt you and others.

All safety messages will follow the safety alert symbol and either the word "DANGER" or "WARNING." These words mean:



You can be killed or seriously injured if you don't immediately follow instructions.



You can be killed or seriously injured if you don't follow instructions.

All safety messages will tell you what the potential hazard is, tell you how to reduce the chance of injury, and tell you what can happen if the instructions are not followed.

IMPORTANT SAFEGUARDS

When using electrical appliances, basic safety precautions should always be followed including the following:

1. Read all instructions.
2. To protect against risk of electrical shock, do not put Stand Mixer in water or other liquid.
3. Close supervision is necessary when any appliance is used by or near children.
4. Unplug Stand Mixer from outlet when not in use, before putting on or taking off parts and before cleaning.
5. Avoid contacting moving parts. Keep hands, hair, clothing, as well as spatulas and other utensils away from beater during operation to reduce the risk of injury to persons and/or damage to the Stand Mixer.
6. Do not operate Stand Mixer with a damaged cord or plug or after the Stand Mixer malfunctions, or is dropped or damaged in any manner. Return appliance to the nearest Authorized Service Center for examination, repair or electrical or mechanical adjustment. Call the KitchenAid Customer Satisfaction Center at 1-800-541-6390 for more information.
7. The use of attachments not recommended or sold by KitchenAid may cause fire, electrical shock or injury.
8. Do not use the Stand Mixer outdoors.
9. Do not let the cord hang over edge of table or counter.
10. Remove flat beater, wire whip or dough hook from Stand Mixer before washing.
11. This product is designed for household use only.

SAVE THESE INSTRUCTIONS

KITCHENAID® STAND MIXER WARRANTY FOR THE 50 UNITED STATES & DISTRICT OF COLUMBIA

This warranty extends to the purchaser and any succeeding owner for Stand Mixers operated in the 50 United States and District of Columbia.

Length of Warranty:	KitchenAid Will Pay For Your Choice of:	KitchenAid Will Not Pay For:
<p>One Year Full Warranty from date of purchase.</p>	<div style="text-align: center;">  </div> <p>Hassle-Free Replacement of your Stand Mixer. See inside front cover for details on how to arrange for service, or call the Customer Satisfaction Center toll-free at 1-800-541-6390. OR The replacement parts and repair labor costs to correct defects in materials and workmanship. Service must be provided by an Authorized KitchenAid Service Center. To arrange for service, follow the instructions under the KitchenAid® Stand Mixer Warranty for Puerto Rico on page 5.</p>	<p>A. Repairs when Stand Mixer is used in other than normal single family home use.</p> <p>B. Damage resulting from accident, alteration, misuse or abuse.</p> <p>C. Any shipping or handling costs to deliver your Stand Mixer to an Authorized Service Center.</p> <p>D. Replacement parts or repair labor costs for Stand Mixers operated outside the 50 United States and District of Columbia.</p>

KITCHENAID DOES NOT ASSUME ANY RESPONSIBILITY FOR INCIDENTAL OR CONSEQUENTIAL DAMAGES. Some states do not allow the exclusion or limitation of incidental or consequential damages, so this exclusion may not apply to you. This warranty gives you specific legal rights and you may also have other rights which vary from state to state.

KITCHENAID® STAND MIXER WARRANTY FOR PUERTO RICO

A limited one year warranty extends to the purchaser and any succeeding owner for Stand Mixers operated in Puerto Rico. During the warranty period, all service **must** be handled by an Authorized KitchenAid Service Center. Please bring the Stand Mixer, or ship it prepaid and insured, to the nearest Authorized Service Center. Call toll-free **1-800-541-6390** to learn the location of a Service Center near you. Your repaired Stand Mixer will be returned to you prepaid and insured.

ARRANGING FOR SERVICE AFTER THE WARRANTY EXPIRES

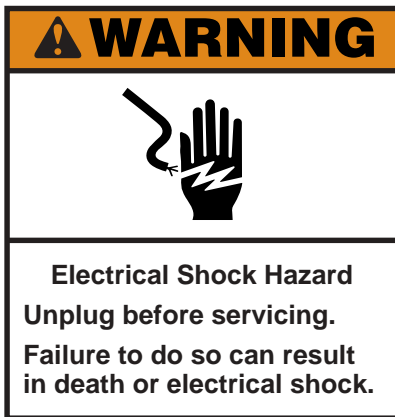

For service information, call toll-free 1-800-541-6390 or write to:
Customer Satisfaction Center
KitchenAid Portable Appliances
P.O. Box 218
St. Joseph, MI 49085-0218

ARRANGING FOR SERVICE OUTSIDE THE 50 UNITED STATES AND PUERTO RICO

Consult your local KitchenAid dealer or the store where you purchased the Stand Mixer for information on how to obtain service.



ORDERING ATTACHMENTS, ACCESSORIES, AND REPLACEMENT PARTS

To order attachments, accessories, or replacement parts for your Stand Mixer, call toll-free 1-800-541-6390 or write to: Customer Satisfaction Center, KitchenAid Portable Appliances, P.O. Box 218, St. Joseph, MI 49085-0218.

ELECTRICAL REQUIREMENTS

Volts: 120 A.C. only. Hertz: 60
The wattage rating for your Stand Mixer is printed on a tag under the mixer base. It is also listed on the trim band.

If the power cord is too short, have a qualified electrician or serviceman install an outlet near the appliance.

 WARNING

<p>Electrical Shock Hazard</p> <p>Plug into a grounded 3 prong outlet.</p> <p>Do not remove ground prong.</p> <p>Do not use an adapter.</p> <p>Failure to follow these instructions can result in death, fire or electrical shock.</p>

TROUBLESHOOTING PROBLEMS

Please read the following before calling your service center.

1. The Stand Mixer may warm up during use. Under heavy loads with extended mixing time periods, you may not be able to comfortably touch the top of the unit. This is normal.
2. The Stand Mixer may emit a pungent odor, especially when new. This is common with electric motors.
3. If the flat beater hits the bowl, stop the Stand Mixer. See “Beater to Bowl Clearance,” page 13.

Keep a copy of the sales receipt showing the date of purchase. Proof of purchase will assure you of in-warranty service.

If your Stand Mixer should malfunction or fail to operate, please check the following:

- Is the Stand Mixer plugged in?
- Is the fuse in the circuit to the Stand Mixer in working order? If you have a circuit breaker box, be sure the circuit is closed.
- Turn the Stand Mixer off for 10-15 seconds, then turn it back on. If the mixer still does not start, allow it to cool for 30 minutes before turning it back on.
- If the problem is not due to one of the above items, see the “KitchenAid® Stand Mixer Warranty” or “Arranging for Service After the Warranty Expires” on pages 4 and 5.
- Do not return the Stand Mixer to the retailer as they do not provide service.

TILT-HEAD STAND MIXER FEATURES



ASSEMBLING YOUR TILT-HEAD STAND MIXER

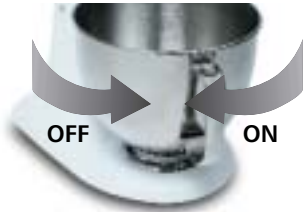

To Attach Bowl

1. Turn speed control to OFF.
2. Unplug stand mixer or disconnect power.
3. Tilt motor head back.
4. Place bowl on bowl clamping plate.
5. Turn bowl gently into clockwise direction.
6. Plug mixer into proper electrical outlet.**

To Remove Bowl

1. Turn speed control to OFF.
2. Unplug stand mixer or disconnect power.
3. Tilt motor head back.
4. Turn bowl counterclockwise.

To Attach Flat Beater, Wire Whip, or Dough Hook

1. Turn speed control to OFF.
2. Unplug stand mixer or disconnect power.
3. Tilt motor head back.
4. Slip beater onto beater shaft and press upward as far as possible.
5. Turn beater to right, hooking beater over pin on shaft.
6. Plug mixer into proper electrical outlet.**

To Remove Flat Beater, Wire Whip or Dough Hook

1. Turn speed control to OFF.
2. Unplug stand mixer or disconnect power.
3. Tilt motor head back.
4. Press beater upward as far as possible and turn left.
5. Pull beater from beater shaft.

To Lock Motor Head

1. Make sure motor head is completely down.
2. Place locking lever in LOCK position.
3. Before mixing, test lock by attempting to raise head.

To Unlock Motor Head

1. Place lever in UNLOCK position.

NOTE: Motor head should always be kept in LOCK position when using mixer.

To Operate Speed Control

Plug mixer in proper electrical outlet.** Speed control lever should always be set on lowest speed for starting, then gradually moved to desired higher speed to avoid splashing ingredients out of bowl. See page 14 for Speed Control Guide.

WARNING

Injury Hazard

Unplug mixer before touching beaters.

Failure to do so can result in broken bones, cuts or bruises.



USING YOUR POURING SHIELD*

To Attach Pouring Shield

1. Turn speed control to OFF.
2. Unplug stand mixer or disconnect power.
3. Attach flat beater, dough hook, or wire whip and bowl. See page 9.
4. Place the back half of the shield (without the chute) on rim of the bowl.
5. Insert the tabs on the front half of the shield (with the chute) under the tab openings on the back half of the shield, then lower the shield to lock into place.



To Remove Pouring Shield

1. Turn speed control to OFF.
2. Unplug stand mixer or disconnect power.
3. Tilt motor head back.
4. Lift pouring chute from bowl.
5. Slide back half of shield from bowl.
6. Remove attachment and bowl.

To Use Pouring Shield

1. Pour ingredients into bowl through chute portion of shield.

* If Pouring Shield is included.

USING YOUR KITCHENAID® ACCESSORIES



Flat Beater for normal to heavy mixtures:

cakes	biscuits
creamed frostings	quick breads
candies	meat loaf
cookies	mashed potatoes
pie pastry	



Wire Whip for mixtures that need air incorporated:

eggs	sponge cakes
egg whites	angel food cakes
heavy cream	mayonnaise
boiled frostings	some candies



Dough Hook for mixing and kneading yeast doughs:

bread	coffee cakes
rolls	buns

MIXING TIME

Your KitchenAid® Stand Mixer will mix faster and more thoroughly than most other electric Stand Mixers. Therefore, the mixing time in most traditional and non-packaged recipes must be adjusted to avoid overbeating. With cakes, for example, beating time may be half as long as with other Stand Mixers.

TILT-HEAD STAND MIXER USE

NOTE: Do not scrape the bowl while the Stand Mixer is operating.

The bowl and beater are designed to provide thorough mixing without frequent scraping. Scraping the bowl once or twice during mixing is usually sufficient. Turn the unit off before scraping.

The Stand Mixer may warm up during use. Under heavy loads with extended mixing time, you may not be able to comfortably touch the top of the unit. This is normal.

CARE AND CLEANING

Bowl, white flat beater and white dough hook may be washed in an automatic dishwasher. Or, clean them thoroughly in hot sudsy water and rinse completely before drying. Wire whip should be hand washed and dried immediately. Do not wash the wire whip in a dishwasher. Do not store the beaters on the shaft.

NOTE: Always be sure to unplug the Stand Mixer before cleaning. Wipe the Stand Mixer with a soft, damp cloth. Do not use household or commercial cleaners. Do not immerse in water. Wipe off the beater shaft frequently, removing any residue that may accumulate.

BEATER TO BOWL CLEARANCE

Your Stand Mixer is adjusted at the factory so the flat beater just clears the bottom of the bowl. If, for any reason, the flat beater hits the bottom of the bowl or is too far away from the bowl, you can correct the clearance easily.

1. Turn speed control to OFF.
2. Unplug stand mixer or disconnect power.
3. Tilt motor head back.
4. Turn screw (A) SLIGHTLY counter clockwise (left) to raise the flat beater or clockwise (right) to lower the flat beater.
5. Make adjustment so that the flat beater just clears the surface of the bowl. If you over adjust the screw, you may not be able to lock the motor head when it is lowered.



NOTE: When properly adjusted, the flat beater will not strike the bottom or side of the bowl. If the flat beater or the wire whip is adjusted so that it strikes the bowl, the coating may wear off the beater, or the wires on the whip may wear.

SPEED CONTROL GUIDE

Number of Speed

Stir Speed		
	STIR	For slow stirring, combining, mashing, starting all mixing procedures. Use to add flour and dry ingredients to batter, add liquids to dry ingredients, and combine heavy mixtures.
2	SLOW MIXING	For slow mixing, mashing, faster stirring. Use to mix heavy batters and candies, start mashing potatoes or other vegetables, cut shortening into flour, mix thin or splashy batters, and mix and knead yeast dough. Use with Can Opener attachment.
4	MIXING, BEATING	For mixing semi-heavy batters, such as cookies. Use to combine sugar and shortening and to add sugar to egg whites for meringues. Medium speed for cake mixes. Use with: Food Grinder, Rotor Slicer/Shredder, and Fruit/Vegetable Strainer.
6	BEATING, CREAMING	For medium fast beating (creaming) or whipping. Use to finish mixing cake, doughnut, and other batters. High speed for cake mixes. Use with Citrus Juicer attachment.
8	FAST BEATING, WHIPPING	For whipping cream, egg whites, and boiled frostings.
10	FAST WHIPPING	For whipping small amounts of cream or egg whites. Use with Pasta Maker and Grain Mill attachments.

NOTE: Mixer may not maintain fast speeds under heavy load, such as when the Pasta Maker or Grain Mill attachments are used. This is normal.

NOTE: The Speed Control Lever can be set between the speeds listed in the above chart to obtain speeds 3, 5, 7, and 9 if a finer adjustment is required.

Do not exceed Speed 2 when preparing yeast dough. This may damage the mixer.

MIXING TIPS

Converting Your Recipe for the Mixer

The mixing instructions for recipes in this book can guide you in converting your own favorite recipes for preparation with your KitchenAid® Stand Mixer. Look for recipes similar to yours and then adapt your recipes to use the procedures in the similar KitchenAid recipes.

For example, the “quick mix” method (sometimes referred to as the “dump” method) is ideal for simple cakes, such as the Quick Yellow Cake and Easy White Cake included in this book. This method calls for combining dry ingredients with most or all liquid ingredients in one step.

More elaborate cakes, such as tortes, should be prepared using the traditional cake mixing method. With this method, sugar and the shortening, butter, or margarine are thoroughly mixed (creamed) before other ingredients are added.

For all cakes, mixing times may change because your KitchenAid® Stand Mixer works more quickly than other mixers. In general, mixing a cake with the KitchenAid® Stand Mixer will take about half the time called for in most traditional and non-packaged cake recipes.

To help determine the ideal mixing time, observe the batter or dough and mix only until it has the desired appearance described in your recipe, such as “smooth and creamy.”

To select the best mixing speeds, use the Speed Control Guide on page 14.

Adding Ingredients

Always add ingredients as close to side of bowl as possible, not directly into the moving beater. The Pouring Shield can be used to simplify adding ingredients.

NOTE: If ingredients in very bottom of bowl are not thoroughly mixed, then the beater is not far enough into the bowl. See “Beater to Bowl Clearance” on page 13.

Cake Mixes

When preparing packaged cake mixes, use Speed 2 for low speed, Speed 4 for medium speed, and Speed 6 for high speed. For best results, mix for the time stated on the package directions.

Adding Nuts, Raisins, or Candied Fruits

Follow individual recipes for guidelines on including these ingredients. In general, solid materials should be folded in the last few seconds of mixing on Stir Speed. The batter should be thick enough to prevent the fruit or nuts from sinking to the bottom of the pan during baking. Sticky fruits should be dusted with flour for better distribution in the batter.

Liquid Mixtures

Mixtures containing large amounts of liquid ingredients should be mixed at lower speeds to avoid splashing. Increase mixer speed only after the mixture has thickened.

EGG WHITES

Place room temperature egg whites in a clean, dry bowl. Attach bowl and wire whip. To avoid splashing, gradually turn to designated speed and whip to the desired stage. See chart below.

AMOUNT	SPEED	
1 egg white...	GRADUALLY to 10	Soft Peak Tips of peaks fall over when wire whip is removed.
2-4 egg whites...	GRADUALLY to 8	Almost Stiff Sharp peaks form when wire whip is removed, but whites are actually soft.
6+ egg whites...	GRADUALLY to 8	Stiff but not Dry Sharp, stiff peaks form when wire whip is removed. Whites are uniform in color and glisten.

Whipping Stages
With your KitchenAid® mixer, egg whites whip quickly. So, watch carefully to avoid overwhipping. This list tells you what to expect.

Frothy
Large, uneven air bubbles.

Begins to Hold Shape
Air bubbles are fine and compact; product is white.

Stiff and Dry
Sharp, stiff peaks form when wire whip is removed. Whites are speckled and dull in appearance.

WHIPPED CREAM

Pour cold whipping cream into a chilled bowl. Attach bowl and wire whip. To avoid splashing, gradually turn to designated speed and whip to the desired stage. See chart below.

AMOUNT	SPEED	
¼ cup	GRADUALLY to 10	Begins to Thicken Cream is thick and custard-like.
½ cup	GRADUALLY to 10	Holds Its Shape Cream forms soft peaks when wire whip is removed. Can be folded into other ingredients when making desserts and sauces.
1 cup	GRADUALLY to 8	Stiff Cream stands in stiff, sharp peaks when wire whip is removed. Use for topping on cakes or desserts, or filling for cream puffs.
1 pint	GRADUALLY to 8	

Whipping Stages
Watch the cream closely during whipping. Because your KitchenAid® mixer whips so quickly, there are just a few seconds between whipping stages. Look for these characteristics:

ATTACHMENTS AND ACCESSORIES

General Information

KitchenAid® attachments are designed to assure long life. The attachment power shaft and hub socket are of a square design, to eliminate any possibility of slipping during the transmission of power to the attachment. The hub and shaft housing are tapered to assure a snug fit, even after prolonged use and wear. KitchenAid® attachments require no extra power unit to operate them; the power unit is built in.

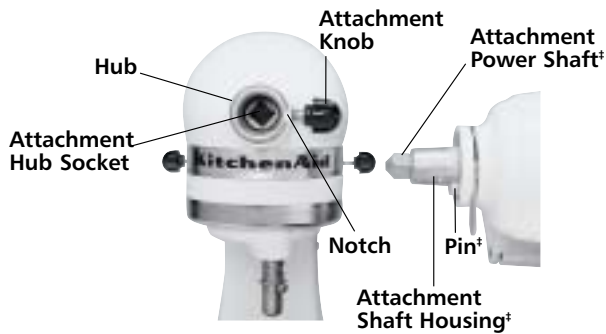

*Not part of mixer.

GENERAL INSTRUCTIONS

To Attach

1. Turn the speed control to OFF.
2. Unplug mixer or disconnect power.
3. Loosen the attachment knob by turning it counterclockwise, and remove the attachment hub cover.
4. Insert the attachment shaft housing into the attachment hub, making certain the attachment power shaft fits into the square attachment hub socket. It may be necessary to rotate the attachment back and forth. When the attachment is in proper position, the pin on the attachment will fit into the notch on the hub rim.
5. Tighten the attachment knob by turning it clockwise until the attachment is completely secured to mixer.
6. Plug mixer into a proper electrical outlet.**

To Remove

1. Turn the speed control to OFF.
2. Unplug mixer or disconnect power.
3. Loosen the attachment knob by turning it counterclockwise. Rotate the attachment slightly back and forth while pulling it out.
4. Replace the attachment hub cover. Tighten attachment knob by turning it clockwise

GENERAL INSTRUCTIONS FOR MAKING AND KNEADING YEAST DOUGH WITH THE RAPID MIX METHOD

“Rapid Mix” describes a bread baking method that calls for dry yeast to be mixed with other dry ingredients before liquid is added. In contrast, the traditional method is to dissolve yeast in warm water.

1. Place all dry ingredients including yeast into the bowl, except the last 1 to 2 cups of flour.
2. Attach the bowl and dough hook. Lock the mixer head. Turn to Speed 2 and mix about 15 seconds, or until the ingredients are combined.



3. Continuing on Speed 2, gradually add the liquid ingredients to the flour mixture and mix 1 to 2 minutes longer. See A.

NOTE: If the liquid ingredients are added too quickly, they will form a pool around the dough hook and slow down the mixing process.



1. Continuing on Speed 2, gently add the remaining flour, ½ cup at a time. See B. Mix until the dough clings to the hook and cleans the sides of the bowl, about 2 minutes.



2. When the dough clings to the hook, knead on Speed 2 for 2 minutes, or until the dough is smooth and elastic. See C.
3. Unlock the motor head and tilt it back. Remove the dough from the hook. Follow the directions in the recipe for rising, shaping, and baking.

When using the traditional method to prepare a favorite recipe, dissolve the yeast in warm water in a warmed bowl. Add the remaining liquids and dry ingredients, except last the 1 to 2 cups flour. Turn to Speed 2 and mix about 1 minute, or until the ingredients are thoroughly mixed. Proceed with Steps 4 through 6.

Both methods work equally well for bread preparation. However, the “Rapid Mix” method may be a bit faster and easier for new bread bakers. It is slightly more temperature tolerant because the yeast is mixed with dry ingredients, rather than with warm liquid.

?

BREAD MAKING TIPS

Making bread with a mixer is quite different from making bread by hand. Therefore, it will take some practice before you are completely comfortable with the new process. We recommend you start with an easy recipe, like Basic White Bread, until you become accustomed to making bread the KitchenAid way. The following tips will help:

Tips for Mixing and Kneading

- ALWAYS use the dough hook to mix and knead yeast doughs.
- NEVER exceed Speed 2 when using the dough hook.
- NEVER use recipes calling for more than 8 cups of all-purpose flour or 6 cups of whole wheat flour when making dough with a 4½-quart tilt-head mixer.
- NEVER use recipes calling for more than 9 cups of all-purpose flour or 6 cups of whole wheat flour when making dough with a 5-quart tilt-head mixer.
- Most bread recipes give a range for the amount of flour to use. When the dough clings to the hook and cleans the sides of the bowl, enough flour has been added. If the dough is sticky or the humidity is high, slowly add more flour (about 1/2 cup at a time), but NEVER exceed the recommended flour capacity. Knead after each addition until the flour is completely worked into the dough. If too much flour is added, a dry loaf will result.
- Some types of dough, especially those made with whole grain flours, may not form a ball on the hook. However, as long as the hook comes in contact with the dough, kneading will be accomplished.
- Some large recipes and soft doughs may occasionally climb over the collar of the hook. This usually indicates that the dough is sticky and more flour should be added. The sooner all the flour is added, the less likely the dough will climb the hook. For such recipes, try starting with all but the last cup of flour in the initial mixing process. Then add the remaining flour as quickly as possible.
- Use a candy or other kitchen thermometer to assure that liquids are at the temperature specified in the recipe. Liquids at higher temperature can kill the yeast, while liquids at lower temperatures will retard yeast growth.
- Warm all ingredients to room temperature to insure the proper rising of dough. If the yeast is to be dissolved in the bowl, always warm the bowl first by rinsing with warm water to prevent cooling of liquids.

?

BREAD MAKING TIPS

Tips for Shaping a Loaf



Divide the dough in half. On a lightly floured surface, roll each half into a rectangle, approximately 9x14 inches. A rolling pin will smooth the dough and remove gas bubbles.



Starting at a short end, roll the dough tightly. Pinch to seal the seam.



Pinch the ends and turn them under. Place the dough, seam side down, in a loaf pan. Follow the directions in the recipe for rising and baking.

Tips for Successful Rising & Baking

- Allow the bread to rise in a warm place, 80°F to 85°F, free from drafts, unless otherwise specified in the recipe.
- Always cover the bowl with a towel to retain warmth and protect the dough from drafts. If desired, cover the bowl with waxed paper before covering it with a towel.
- Here are some alternative rising methods to use: (1) The bowl containing the dough can be placed on a wire rack over a pan of hot water. (2) The bowl can be placed on the top rack of an unheated oven; put a pan of hot water on the rack below. (3) Turn the oven to 400°F for 1 minute, then turn it off; place the bowl on the center rack of the oven and close the door.
- Recipe rising times may vary due to the temperature and humidity of your kitchen. If an indentation remains after pressing the tips of your fingers lightly and quickly into the dough, it has doubled in bulk.
- When done, yeast breads and rolls will be deep golden brown in color. Tapping on the top of the loaf should produce a hollow sound, and the bread should pull away from the sides of the pan easily.
- Turn loaves and rolls onto racks immediately after baking to prevent sogginess.

?