

PowerWash Deluxe

USER'S GUIDE

1694 SERIES—220/240V

3 Safety Instructions

4 Product view

5-6 Assembly

6-14 Operations / Special Tools

14-16 Routine Maintenance

17-18 Troubleshooting

19 Replacement Parts

20 Warranty





Thanks for buying a BISSELL PowerWash Deluxe Deep Cleaner

We're glad you purchased a BISSELL PowerWash Deluxe Deep Cleaner. Everything we know about floor care went into the design and construction of this complete, high-tech home cleaning system.

Your PowerWash Deluxe is well made, and we back it with a full one-year warranty. We also stand behind it with a knowledgeable, dedicated Consumer Services department, so, should you ever have a problem, you'll receive fast, considerate assistance.

My great-grandfather invented the floor sweeper in 1876. Today, BISSELL is a global leader in the design, manufacture, and service of high quality homecare products like your PowerWash Deluxe.

Thanks again, from all of us at BISSELL.

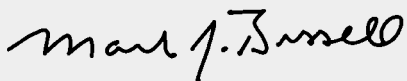

Mark J. Bissell
President and Chief Executive Officer

IMPORTANT SAFETY INSTRUCTIONS

⚠️ WARNING: When using an electrical appliance, basic precautions should be observed, including the following: Read all instructions before using your PowerWash Deluxe deep cleaner. To reduce the risk of electric shock, use indoors only. Do not immerse. Use only on surfaces moistened by cleaning process. Always connect to a properly Earthed Outlet. Unplug from outlet when not in use and before conducting maintenance or troubleshooting.

- Do not leave machine when it is plugged in
- Do not service machine when it is plugged in
- Do not use with damaged cord or plug
- Do not use machine if it has been dropped, damaged, left outdoors or dropped into water
- Do not expose to rain, store indoors.
- Do not handle unit with wet hands
- Do not pull or carry by cord, use cord as a handle, close door on cord, pull cord around sharp corners or edges, run appliance over cord, or expose cord to heated surfaces
- Do not carry the appliance while in use
- Do not unplug by pulling on cord. Unplug by grasping plug
- Do not handle plug or appliance with wet hands
- Do not put any object into appliance openings, use with blocked opening, or restrict air flow
- Do not expose hair, loose clothing, fingers or body parts to openings or moving parts
- Do not pick up hot or burning objects
- Do not pick up flammable or combustible materials (lighter fluid, petrol, kerosene, etc.) or use in the presence of explosive liquids or vapour
- Do not use appliance in an enclosed space filled with vapours given off by oil base paint, paint thinner, some moth proofing substances, flammable dust, or other explosive or toxic vapours
- Do not pick up toxic material (chlorine bleach, ammonia, drain cleaner, petrol, etc.)
- Do not modify the 3-pin Earthed plug
- Do not allow to be used as a toy
- Do not use for any purpose other than described in this User's Guide
- Use only manufacturer's recommended attachments

- Use only cleaning products formulated by BISSELL for use in this appliance
- Keep openings free of dust, lint, hair, etc.
- Keep appliance on a level surface
- Turn off all controls before unplugging
- Unplug by grasping the plug, not the cord
- Be extra careful when cleaning stairs
- Pay close attention when working around children

SAVE THESE INSTRUCTIONS.
THIS MODEL IS FOR INDOOR USE ONLY.

⚠️ WARNING: This appliance must be earthed.

IMPORTANT

GROUNDING INSTRUCTIONS

This appliance must be grounded. If it should malfunction or break down, grounding provides a safe path of least resistance for electrical current, reducing the risk of electrical shock. This appliance is equipped with a cord having an equipment grounding conductor and grounding plug. The plug must be inserted in the appropriate outlet that is properly installed and grounded in accordance with all local codes and ordinances.

⚠️ WARNING: Improper connection of the equipment grounding conductor can result in a risk of electric shock. Check with a qualified electrician or service person if you are in doubt as to whether the outlet is properly grounded. Do not modify the plug provided with this appliance. If it will not fit the outlet, have a proper outlet installed by a qualified electrician.

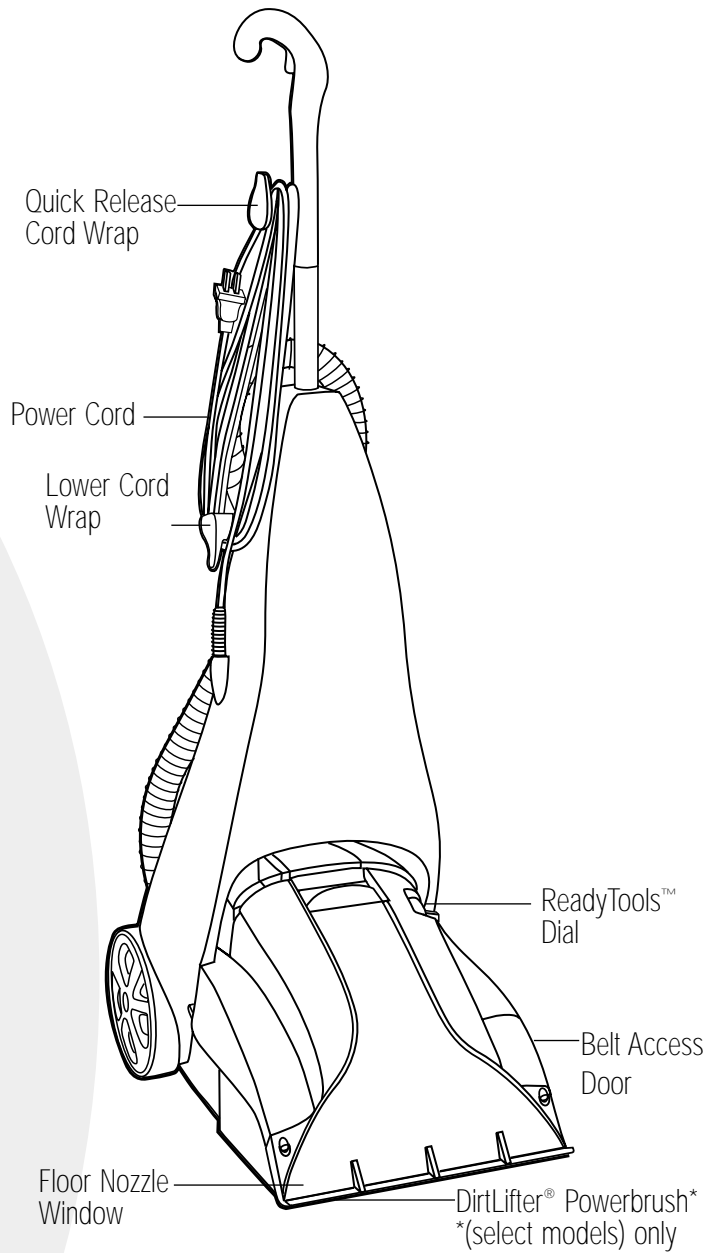
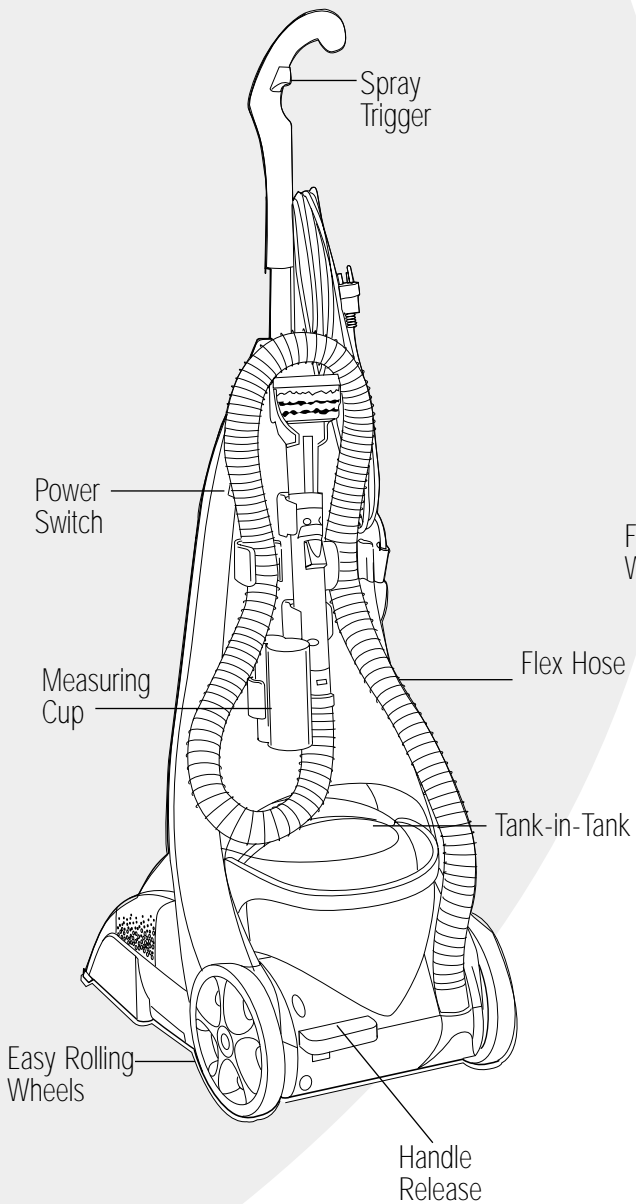

⚠ WARNING:
 To reduce the risk of fire, use only BISSELL Fibre Cleansing Formula™ in your PowerWash Deluxe. Use of cleaning formulas that contain lemon or pine oil may damage this appliance and void warranty. Chemical spot cleaners or solvent-based soil removers should not be used. These products may react with the plastic materials used in your PowerWash Deluxe causing cracking or pitting.

How to use this guide

This user's guide is designed to help you get maximum satisfaction from your PowerWash Deluxe Deep Cleaner. Enclosed you'll find assembly instructions for cleaning tasks, safety precautions, cleaning tips, maintenance and troubleshooting information. Please read this guide thoroughly before assembling and using your cleaner. Pay particular attention to the assembly diagram, assembly instructions, and part names. Locate and organize all parts before assembly. Familiarize yourself with all parts and features and how they operate. Following the Guide will enhance your ability to get top performance from your cleaner for many years.

How To Assemble Your PowerWash Deluxe

Your PowerWash Deluxe assembles in two quick steps. The only tool you will need to assemble your cleaner is a Phillips head  screwdriver.

Your PowerWash Deluxe is packaged as two primary components... the Lower Body and the Handle Assembly. To assemble:

- 1.** Slide the Handle Assembly (with attached Quick Release Cord Wrap™) down into the Lower Body until it will go no further.
- 2.** Secure the handle by placing one (1) Phillips head  screw (supplied) through the screw opening in the Lower Body and into the rear of the Handle Assembly. Tighten with screwdriver until secure.

Assembly is now complete.

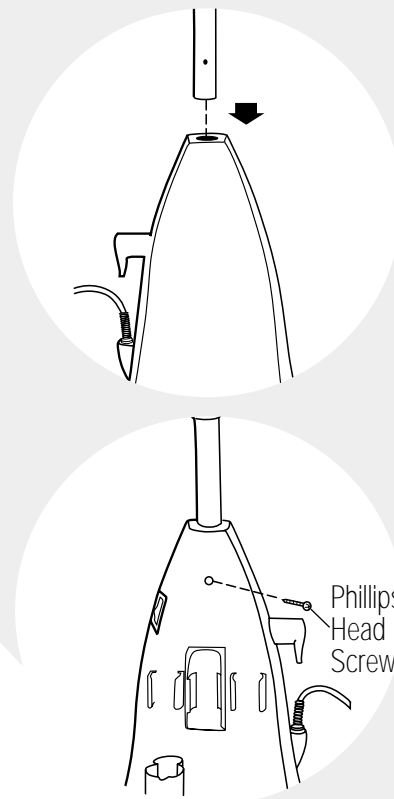

What Comes With Your PowerWash Deluxe



Bare Floor Tool

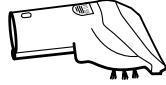

Tough Stain Brush



32 oz. Fibre
Cleansing Formula™



32 oz. Floor
Cleansing Formula™

Keep plenty of BISSELL Fibre Cleansing Formula and Floor Cleansing Formula™ on hand so you can clean whenever it fits your schedule. Always use BISSELL deep cleaning formulas. Non-BISSELL cleaning solutions may harm your cleaner and void the warranty.

The Basics: How Your PowerWash Deluxe works

Power

The Power Switch controls power to the machine.

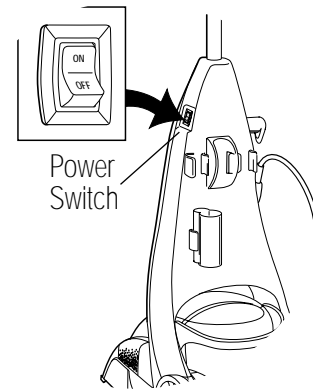

DirtLifter® Powerbrush *(on select models)

The powered brush roll at the floor nozzle is designed to enhance cleaning performance. The bristle pattern lifts out the deep down dirt while gently grooming carpet fibers. The floating suspension self-adjusts to all carpet heights and protects your carpet if you leave the Power Switch ON. When the machine handle is in the fully upright position, CarpetSaver™ automatically raises the brush off the carpet.

Tip:

Deep cleaning carpeting and upholstery regularly can reduce dust and allergens in your home.

Measuring Cup

Your PowerWash Deluxe is equipped with a Measuring Cup for adding the proper amount of cleaning formula to the Tank-in-Tank™. Before using the machine, simply fill the Measuring Cup to the fill line with BISSELL Fibre Cleansing Formula. Pour the formula into the Tank-in-Tank as shown. For convenience, the Measuring Cup stores on the back of the unit.



WARNING:

To reduce the risk of fire, electric shock or injury unplug from outlet before servicing.

To Fill The Tank-in-Tank

This easy-to-use system is designed with a bladder inside to hold clean water. As you clean, the bladder will empty. Dirty water collects in the tank outside the bladder.

NOTE: Make sure to add formula to the tank before filling it with water.

1. Depress the Handle Release pedal to lay the machine handle down, out of the way.
2. Lift the Tank-in-Tank handle. The handle locks the lid in place. Carry the Tank-in-Tank like a bucket to fill at the sink.
3. Set the tank down and rotate the handle forward to unlatch the lid. Lift off and set the lid aside.
4. Find the mouth of the bladder and fill to the bottom of the neck with hot tap water. **Do not boil or microwave water.**

NOTE: Fill the bladder with water only. Fill slowly to reduce sudsing.

5. Replace the tank lid, matching the lid and tank edges. Rotate the handle to carrying position. Replace tank in machine base, seating firmly in place. Rotate handle back down to latched position.

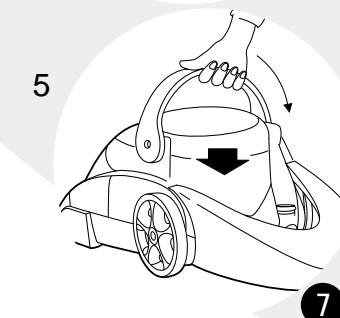
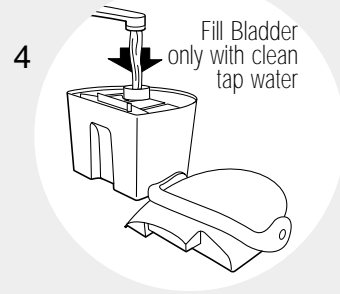
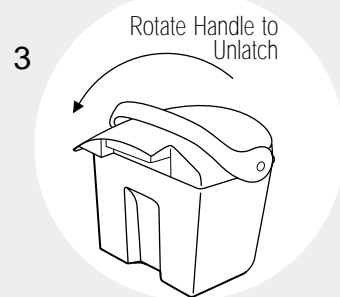
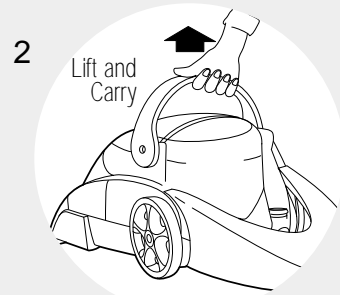
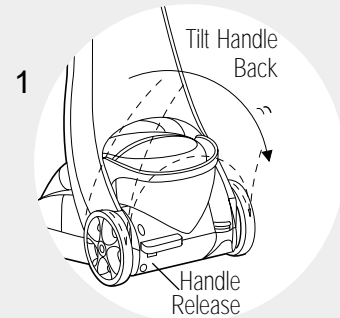
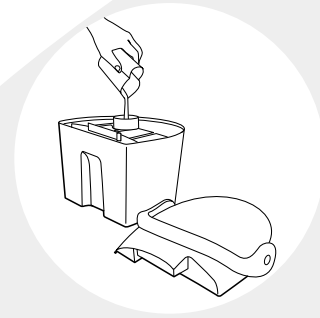

When It's Time To Empty The Tank-in-Tank

NOTE: Remove the Tank-in-Tank, following steps 1. and 2. on page 7.

- 1.** Carry the Tank-in-Tank, like a bucket, to the sink. Remove tank lid. Pour out dirty water.
- 2.** After each use, remove and rinse the lint screen located on the tank lid.
 - A.** Remove tank lid.
 - B.** Remove lint screen and rinse under tap. Remove any debris caught in lint screen.
 - C.** Reinsert lint screen on tank lid. The screen will click into place.
 - D.** Replace tank lid.
- 3.** Refill with cleaning solution and clean tap water—follow steps 4. on page 7.
- 4.** When a cleaning job is complete, rinse out the Tank-in-Tank by running clean water between the bladder and the tank.
- 5.** Return the Tank-in-Tank to the machine, follow step 5 on page 7.
- 6.** Refer to the Storage section on page 14 for final cleanup.

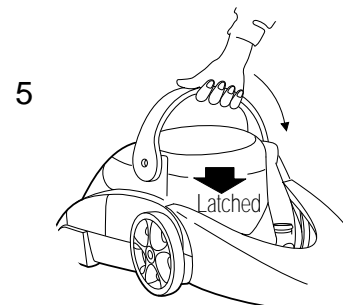
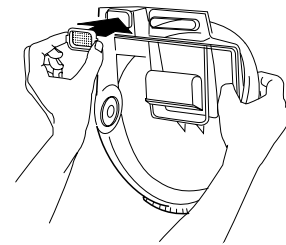
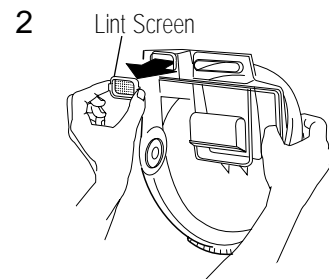
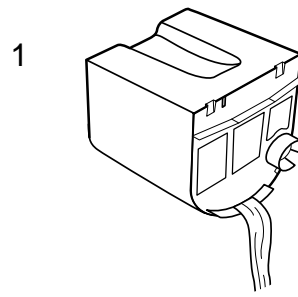

Tip:

A special red float device in the tank will cause the cleaner to stop removing solution from the carpet and the motor sound will rise in pitch to let you know the dirty water tank is full.

ReadyTools™ Dial

This provides floor or upholstery cleaning with the turn of a dial. For carpet/floor cleaning make sure the dial is set to floor cleaning. For upholstery or fabric cleaning, select your cleaning tool, attach it to the Flex Hose, and the PowerWash Deluxe is ready to clean upholstery, fabrics and more*.

* Set the switch to **FLOOR CLEANING** when cleaning carpets, or set it to **TOOLS/PRETREAT** when using the Flex Hose attachments.

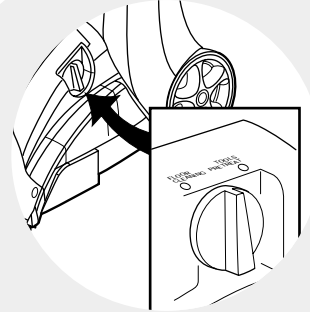

How To Clean Carpets

1. Plan activities to give carpet time to dry.
2. Remove easily moved furniture from the room (chairs, lamps, coffee tables, etc.).
3. Vacuum thoroughly to pick up loose debris and pet hair before using the PowerWash Deluxe.
4. Plan your cleaning route to leave an exit path. It is best to begin cleaning in the corner farthest from your exit.

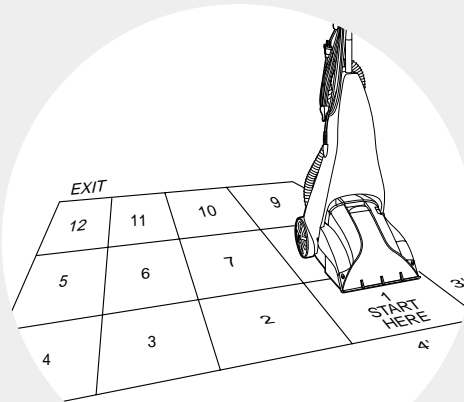

NOTE: You may notice hair and debris deposits on carpet that were loosened by brushing action (especially with newer carpets that have never been deep cleaned before). This debris should be picked up by hand and thrown away. Debris that deposits in the Brush Belt area should be cleaned out to keep Belts running free.

Pre-Treating (Optional)

Improves cleaning effectiveness for heavily soiled carpet in high traffic areas, such as entryways and hallways.

1. Set the ReadyTools Dial to TOOLS/PRETREAT.
2. Plug the PowerWash Deluxe into a proper outlet and turn ON the Power switch.
3. While pressing the Spray Release trigger, slowly make several passes over the area to be cleaned.
Caution: Do not overwet.
4. Turn the machine Power Switch OFF and let BISSELL Fibre Cleansing Formula dissolve the tough soil for 1 to 2 minutes. Reset the ReadyTools Dial to FLOOR CLEANING before continuing.

Normal Cleaning

1. Plug the PowerWash Deluxe into a proper outlet and turn ON the Power Switch.
2. While pressing the Spray Release trigger, make one slow forward and back wet pass. Let the BISSELL Fibre Cleansing Formula and DirtLifter Power Brush* do the work for you.
***On select models**
Caution: Do not overwet.
3. Release the trigger and make one slow forward and back pass over the same area to remove any residual dirty water.
4. Repeat cleaning passes without pressing the trigger until you can't see any more water being suctioned up.
5. When cleaning job is complete, refer to the Maintenance/Storage section on page 14.

Tip:

Thorough vacuuming before deep cleaning will prevent early clogging of the lint trap.

How To Clean Upholstery and Small Areas

Important - Check Upholstery Tags

Check manufacturer's tag before cleaning. A "W" or "WS" on the tag means you can use your PowerWash Deluxe. If the tag is coded with an "X" or "S" (with a diagonal strike through), or says "Dry Clean Only," do not proceed. Do not use your PowerWash Deluxe on velvet or silk. If manufacturer's tag is missing or not coded, check with your furniture dealer.

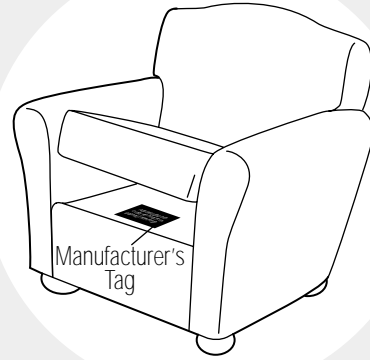

Check for colourfastness in an inconspicuous place.

If possible, check upholstery stuffing. Coloured stuffing may bleed through fabric when wet.

Plan activities to give upholstery time to dry.

Vacuum thoroughly to pick up loose debris and pet hair. Use a vacuum with a brush attachment and a crevice tool to clean in fabric folds and tufts.

Machine Preparation

1. Set up the machine following instructions in The Basics section, pages 6-8.
2. Using the Measuring Cup provided, pour BISSELL Fibre Cleansing Formula into the Tank-in-Tank.
3. Set the ReadyTools Dial to TOOLS/PRETREAT.

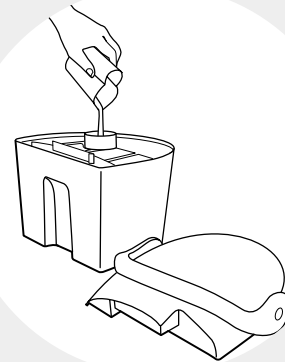

Cleaning Bare Floors

The Bare Floor Tool provides effective cleaning for linoleum, vinyl, and tile floors.
Caution: Do not use on hardwood floors

1. Use BISSELL Floor Cleaning Formula.
2. Vacuum or sweep thoroughly to pick up loose debris and pet hair
3. Remove easily moved furniture from the room, (chairs, tables, etc.)
4. Plan your cleaning route to leave an exit path.
5. Plan activities to allow 30 minutes for the floor to dry completely.

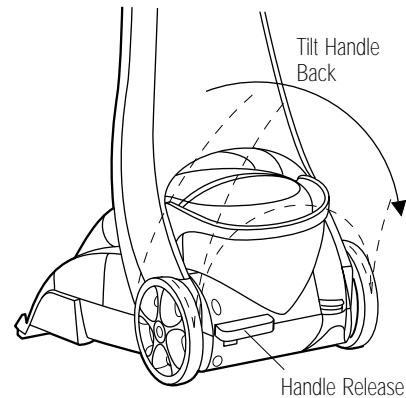

Attach the Bare Floor Tool

1. Step on the handle release to lay the machine handle down.
2. Remove the Tank-in Tank from the machine base.
3. Lift the machine base to expose the underside of the nozzle.
4. Attach Bare Floor Tool to nozzle with long tab to the right side (ReadyTools side) of the nozzle.
5. First attach left side (short Tab) catching tab over nozzle edge.
6. Gently bend long tab (right side) outward to easily snap over edge of clear nozzle on left.

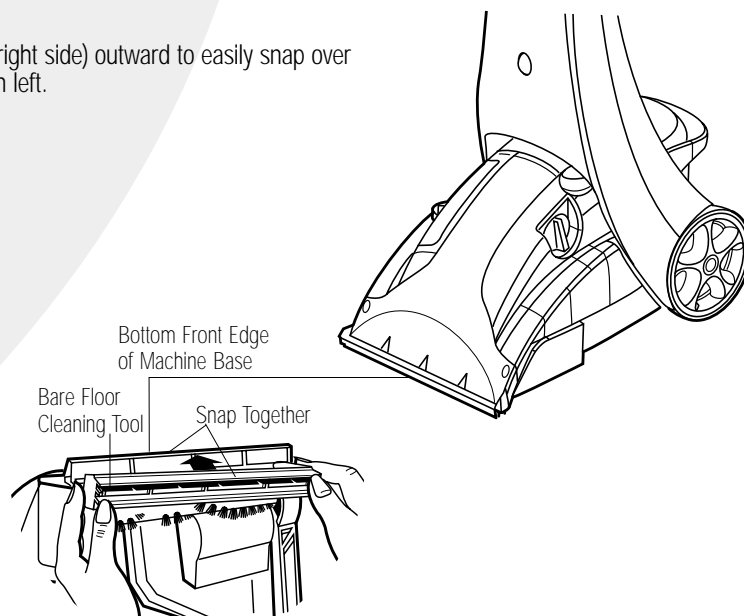
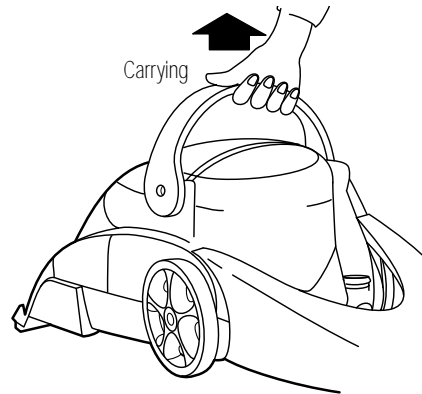

Cleaning Bare Floors Continued

Machine Preparation

1. Set up machine following instructions in the **The Basics** section, pages 6-8. Be sure to thoroughly rinse out any remaining Fibre Cleansing Formula from the Tank-in-Tank to prevent slippery linoleum, vinyl, and tile floors. **Use BISSELL Floor Cleansing Formula in the Tank-in-Tank.**
2. Check ReadyTools dial - it should be set on Floor Cleaning.
3. Plug into a proper outlet and turn Power Switch on.

Bare Floor Cleaning Technique

1. Slowly move the machine nozzle with Bare Floor Tool forward and back over soiled surface one time while pressing the trigger. **Caution: Do not over wet.**
2. Repeat the motion without pressing the trigger using the Bare Floor Tool to squeegee and suction up the dirty water.
3. Repeat steps 1 and 2 backing along the exit path.
4. Allow about 30 minutes for the floor to dry completely.
5. When the cleaning job is complete refer to the **Maintenance/Storage** section on page 14-16.
6. To remove Bare Floor Tool gently bend long tab (right side) outward and pull tool down away from nozzle. Rinse thoroughly, dry and store.