

This Owner's Manual is provided and hosted by Appliance Factory Parts.

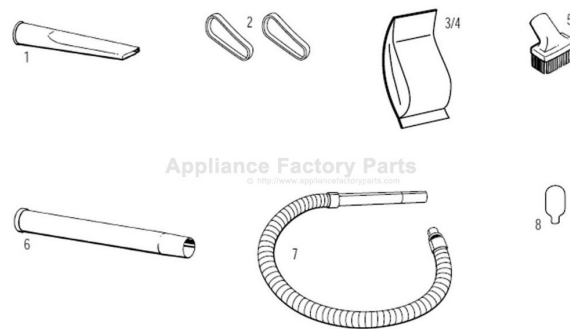

Bissell 3512 Owner's Manual

[Shop genuine replacement parts for Bissell 3512](#)



[Find Your Bissell Vacuum Cleaner Parts - Select From 376 Models](#)

----- Manual continues below -----



User's Guide

Model 3512 Series

- Assembly
- Operation
- Maintenance
- Troubleshooting

Thanks for buying a BISSELL Upright Vacuum Cleaner.

We're glad you purchased a BISSELL Upright Vacuum Cleaner. Everything we know about floor care went into the design and construction of this powerful, high-tech home vacuuming system.

Your BISSELL Upright Vacuum Cleaner is well made, and we back it with a comprehensive limited one-year warranty. We also stand behind it with a knowledgeable, dedicated Consumer Services department, so, should you ever have a problem, you'll receive fast, considerate assistance.

My great-grandfather invented the floor sweeper in 1876. Today, BISSELL is a global leader in the design, manufacture, and service of high quality homecare products like your BISSELL Upright Vacuum Cleaner.

Thanks again, from all of us at BISSELL.

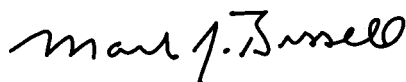

Mark J. Bissell
President and Chief Executive Officer

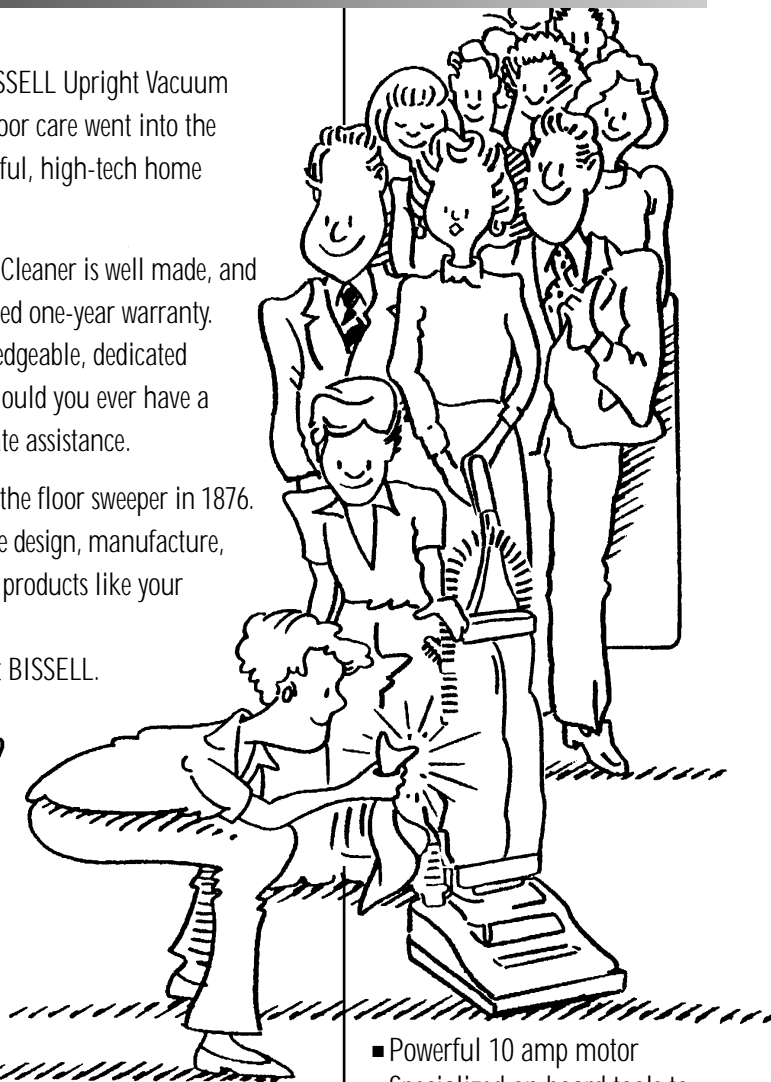

- Powerful 10 amp motor
- Specialized on board tools to meet all vacuuming needs
- Multi-surface height settings
- Wide beam headlight
- Dual edge cleaning action

IMPORTANT SAFETY INSTRUCTIONS

When using an electrical appliance, basic precautions should be observed, including the following:

READ ALL INSTRUCTIONS BEFORE USING YOUR UPRIGHT VACUUM.

Always connect to a polarized outlet (left slot is wider than right). Unplug from outlet when not in use and before conducting maintenance.

⚠ WARNING: To reduce the risk of fire, electric shock, or injury:

- Do not modify the polarized plug to fit a non-polarized outlet or extension cord.
- Do not leave vacuum cleaner unattended when it is plugged in.
- Unplug from outlet when not in use and before servicing.
- Do not use outdoors or on wet surfaces.
- Do not allow children to operate vacuum cleaner or use as a toy.
- Close attention is necessary when used by or near children.
- Do not use for any purpose other than described in this User's Guide.
- Use only manufacturer's recommended attachments.
- Do not use with damaged cord or plug.
- If appliance is not working as it should, has been dropped, damaged, left outdoors, or dropped into water, return it to a service center.
- Do not pull or carry by cord, use cord as a handle, close a door on cord, or pull cord around sharp edges or corners. Do not run appliance over cord. Keep cord away from heated surfaces.
- Do not unplug by pulling on cord. To unplug, grasp the plug, not the cord.
- Do not handle vacuum cleaner or plug with wet hands.
- Do not put any object into openings. Do not use with any opening blocked; keep openings free of dust, lint, hair, and anything that may reduce air flow.

- Keep hair, loose clothing, fingers, and all parts of body away from openings and moving parts.
- Turn off all controls before plugging or unplugging vacuum cleaner.
- Use extra care when cleaning stairs.
- Do not pick up flammable materials (lighter fluid, gasoline, kerosene, etc.) or use in the presence of explosive liquids or vapors.
- Do not pick up toxic material (chlorine bleach, ammonia, drain cleaner, etc.).
- Do not use vacuum cleaner in an enclosed space filled with vapors given off by oil base paint, paint thinner, some moth proofing substances, flammable dust, or other explosive or toxic vapors.
- Do not pick up hard or sharp objects such as glass, nails, screws, coins, etc.
- Do not pick up anything that is burning or smoking, such as cigarettes, matches, or hot ashes.
- Do not use without dust bag and/or filters in place.
- Use only on dry, indoor surfaces.
- Keep appliance on a level surface.
- Do not carry the vacuum cleaner while it is running.

SAVE THESE INSTRUCTIONS FOR FUTURE USE.

THIS APPLIANCE HAS A POLARIZED PLUG.

To reduce the risk of electric shock, this appliance has a polarized plug (one blade is wider than the other). This plug will fit in a polarized outlet only one way. If the plug does not fit fully in the outlet, reverse the plug. If it still does not fit, contact a qualified electrician to install a proper outlet. Do not change the plug in any way.

This model is for household use only.

BISSELL Upright Vacuum Cleaner Order Form

Order Information

1

Item	Part No.	Part Name	Qty. x	Unit Price	= Total
1	210-9108	Crevice Tool	_____	\$4.00	_____
2	32015	Drive Belt (2-Pack)	_____	\$3.99	_____
3	32013	Style 2 Microfiltration Dust Bags (3-Pack)	_____	\$5.99	_____
4	32018	Style 2 Dust Bag (3-Pack)	_____	\$2.99	_____
5	210-9104	Combined Upholstery Tool/ Dusting Brush	_____	\$3.46	_____
6	210-9102	Extension Wand	_____	\$4.00	_____
7	310-5005	6' Flex Hose	_____	\$6.79	_____
8	555-9069	Headlight Bulb	_____	\$1.07	_____

Sub Total _____

Sales tax based on delivery address.

Shipping _____

AR, AZ, CA, FL, GA, IL, KS, MA, MD, MI, MN, MO, NC, NE, NJ, NY, OH, PA, TN, TX, UT and WA residents add applicable sales tax.

Sale Tax _____

Price applicable in continental United States only.

Price subject to change without notice.

Order Total _____

2 Shipping Information

Ship To _____
 Address _____

 City _____
 State _____ Zip _____

Shipping and Handling
 \$1.00 to \$4.99 = \$2.95
 \$5.00 to \$49.99 = \$4.95
 \$50.00 to \$99.99 = \$7.95
 \$100.00 to \$229.99 = \$13.95
 \$230.00 and up = \$25.95

UPS 2nd Day = above shipping amount + \$5.75
 UPS Next Day = above shipping amount + \$19.95

3 Billing Information

Charge: Master Card Enclosed in your envelope
 Visa check or money order
 American Express payable to BISSELL Inc.
 Discover (No cash or stamps please)

Telephone _____

Account Number
 (include all digits)

Card Expires
 Month Year Signature _____

MAIL REORDER FORM TO:

BISSELL INC.
 Mail order Department
 P.O. Box 3606
 Grand Rapids, MI 49501

OR FAX TO:
1-616-791-7711

Visit our website at: www.bissell.com



Index

Safety instructions2
 Product view3
 How to put it together4-5
 How to use your upright vacuum cleaner6
 Using special tools7
 Routine maintenance8-11
 Troubleshooting12
 Replacement parts13
 Warranty14
 Consumer services14
 Reorder Form15

⚠ CAUTION: Do not plug in your vacuum cleaner until you are familiar with all instructions and operating procedures.

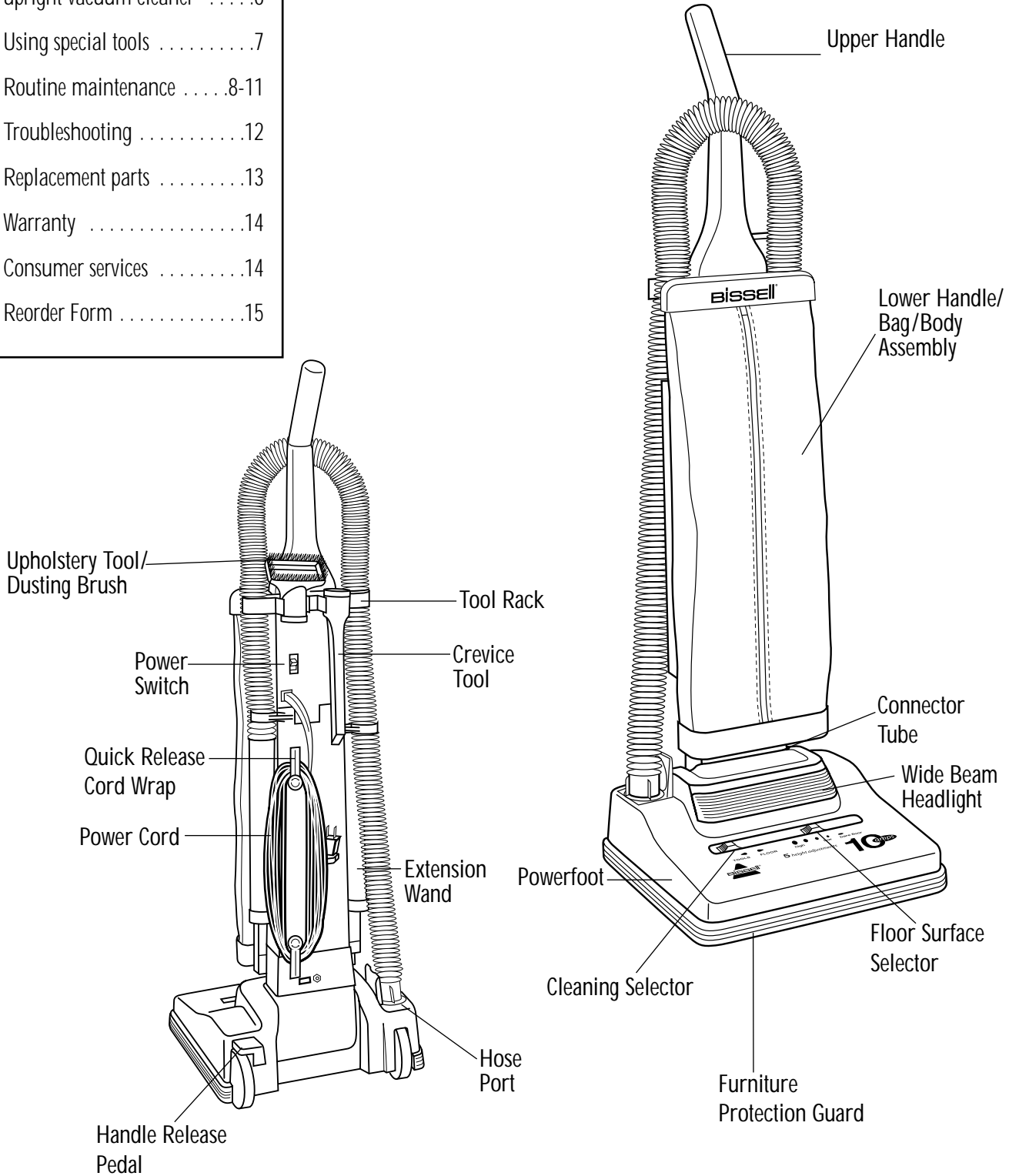

Warranty Information

This warranty gives you specific legal rights, and you may also have other rights which may vary from state to state. If you need additional instruction regarding this warranty or have questions regarding what it may cover, please contact BISSELL Consumer Services by E-mail, telephone, or regular mail as described below.

Limited One Year Warranty

Subject to the *EXCEPTIONS AND EXCLUSIONS identified below, upon receipt of the product BISSELL Inc. will repair or replace (with new or remanufactured components or products), at BISSELL's option, free of charge from the date of purchase by the original purchaser, for one year any defective or malfunctioning part.

See information below on "If your BISSELL product should require service".

This warranty applies to product used for personal, and not commercial or rental service. This warranty does not apply to fans or routine maintenance components such as filters, bags, belts, or brushes. Damage or malfunction caused by negligence, abuse, or use not in accordance with the User's Guide is not covered.

If your BISSELL product should require service:

Call BISSELL Consumer Services at the number below or visit the BISSELL website - www.bissell.com to locate a BISSELL Authorized Service Center in your area. If there are no authorized BISSELL Service Centers in your area, select the "Customer Service" tab, and follow the instructions for contacting us via e-mail. A BISSELL Representative will issue you a Return Authorization Number and a pre-paid mailing label to return the unit to BISSELL for warranty repair.

-- The machine should be returned with a photocopy of your proof of purchase. (Your dated sales receipt is your warranty - do not send original.) If you need information about repairs or replacement parts, or if you have questions about your warranty, select the "Customer Service" tab on our website and follow the instructions for contacting us by e-mail.

Or call:

BISSELL Consumer Services

1-800-237-7691

Monday - Friday 8 a.m. - 7 p.m. EST

Saturday 9 a.m. - 2 p.m. .EST

Or write:

BISSELL INC

PO Box 3606

Grand Rapids MI 49501

ATTN: Consumer Services

BISSELL INC. IS NOT LIABLE FOR INCIDENTAL OR CONSEQUENTIAL DAMAGES OF ANY NATURE ASSOCIATED WITH THE USE OF THIS PRODUCT. BISSELL'S LIABILITY WILL NOT EXCEED THE PURCHASE PRICE OF THE PRODUCT.

Some states do not allow the exclusion or limitation of incidental or consequential damages, so the above limitation or exclusion may not apply to you.

*EXCEPTIONS AND EXCLUSIONS FROM THE TERMS OF THE **LIMITED WARRANTY**

THIS WARRANTY IS EXCLUSIVE AND IN LIEU OF ANY OTHER WARRANTIES EITHER ORAL OR WRITTEN. ANY IMPLIED WARRANTIES WHICH MAY ARISE BY OPERATION OF LAW, INCLUDING THE IMPLIED WARRANTIES OF MERCHANTABILITY AND FITNESS FOR A PARTICULAR PURPOSE, ARE LIMITED TO THE ONE YEAR DURATION FROM THE DATE OF PURCHASE AS DESCRIBED ABOVE.

Some states do not allow limitations on how long an implied warranty lasts, so the above limitation may not apply to you.



©2000 BISSELL Inc
Grand Rapids, Michigan
All rights reserved. Printed in USA.
Part Number 310-5857
Rev 05/01

Visit our website at:
www.bissell.com

How to use this guide

This User's Guide has been designed to help you get the utmost satisfaction from your BISSELL® Upright Vacuum Cleaner. You'll find assembly and operating instructions, safety precautions, as well as maintenance and troubleshooting instructions. Please read this Guide thoroughly before assembling your vacuum cleaner.

Pay particular attention to the product diagram, assembly instructions, and part names.

Locate and organize all parts before assembly. Familiarize yourself with the parts and where they go. Following this User's Guide will greatly enhance your ability to get the most performance from your BISSELL® Upright for many years.

How to put it together

The only tool you'll need to assemble your vacuum cleaner is a Phillips head  screwdriver.

 **WARNING:** Plastic film can be dangerous. To avoid danger of suffocation, keep away from babies and children.

Attach Handle to Powerfoot

1. Place Lower Handle/Bag Assembly onto Powerfoot and push down firmly on top corners while rocking slightly from side to side. You will hear a "click" when raised area on the back of the Powerfoot enters the opening on the back of the lower handle.
2. Press the Handle Release Pedal to lower the handle. From the front insert the bolt through the hole in the Connector Tube. Place the nut over protruding end of the bolt. Tighten with a Phillips head screwdriver.
3. Place Upper Handle onto Lower Handle/Bag Assembly and press until parts snap into place. Insert prong at the top of the Bag Assembly through the hole in the Upper Handle.
4. Place Tool Rack on the back of the Upper Handle above the Power Switch with the holes aligned. The arrow on the Tool Rack should point upwards. Insert the small screw through the hole and tighten.
5. Wrap Power Cord around Cord Wraps at the back of the Lower Handle.
6. Press Selector Knobs onto prongs on Powerfoot.

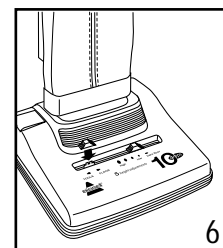
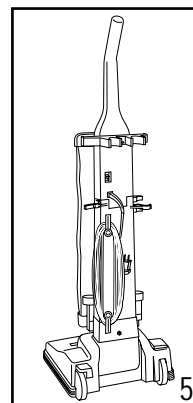
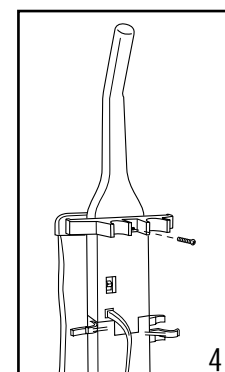
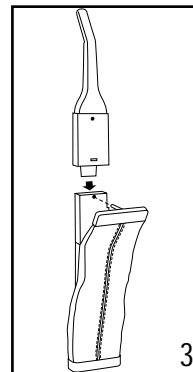
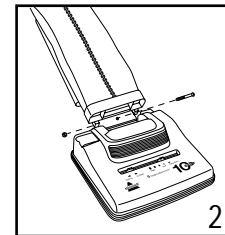
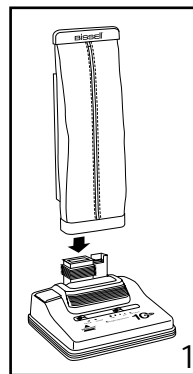

Replacement parts - BISSELL® Upright Vacuum System

Item	Part No.	Part Name
1	2109108	Crevice Tool
2	32015	Drive Belt (2-Pack)
3	32013	Style 2 Microfiltration Dust Bag (3-Pack)
4	32018	Style 2 Dust Bag (3-Pack)
5	2109104	Combination Upholstery Tool/Dusting Brush
6	2109102	Extension Wand
7	3105005	6' Flex Hose
8	5559069	Headlight Bulb

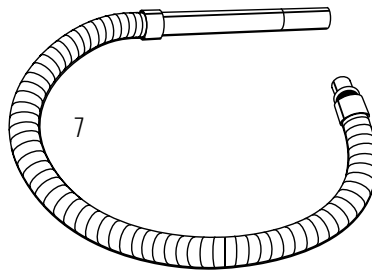
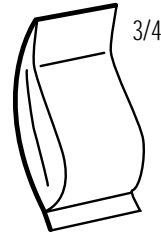
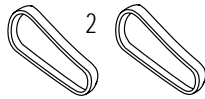

Attach Tools to Vacuum

- 1.** Flip open the Tool Door on the side of the Powerfoot. Insert end of Vacuum Hose into Hose Port fitting tabs into notches, turn clockwise to lock. Hose should be left in place at all times for maximum cleaning performance.
- 2.** Press Hose into outer Hose Clip. Route Hose over top of cleaner pressing into both sides of Tool Rack. Place end of Wand into the round cup and snap hose into clip with wand ring sliding under clip.
- 3.** Attach Tools to Tool Rack as shown. Slide Dusting Brush onto Upholstery Tool for storage. Place Extension Wand into clips at side between Hose and Bag Assembly.

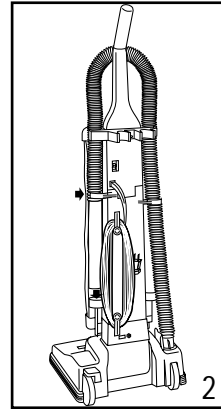
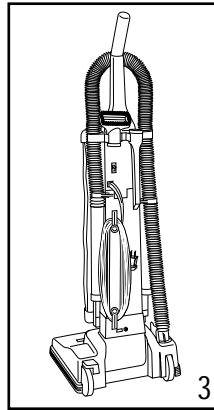
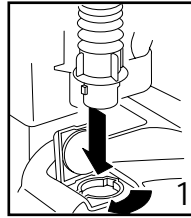

Install Dust Bag

- 1.** Unzip Cloth Bag.
- 2.** Fold down top of new Dust Bag.
- 3.** Grasp Bag Collar and push Collar firmly over raised rib on Connector Tube. Pushing too hard on the Collar may rip the Dust Bag.
- 4.** Tuck remainder of Dust Bag completely into vacuum cleaner. Lay it flat, top to bottom, without bunching.
- 5.** Zip Cloth Bag closed.

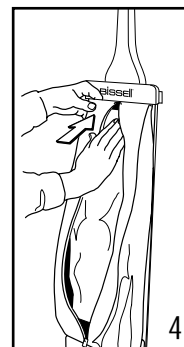
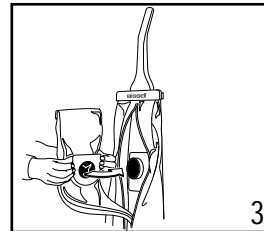

Troubleshooting

Vacuum cleaner won't run.

Possible Causes

Vacuum cleaner is not plugged in
Household fuse/breaker

Remedies

Check electrical plug
Check/replace fuse - Reset breaker
Call BISSELL Consumer Services

Vacuum cleaner won't pick up dirt.

Possible Causes

Incorrect setting
Incorrect Floor Surface Selector setting
Height adjustment too high
Paper Dust Bag is full
Rotating Brush Drive Belt broken
Drive Belt stretched/
off Motor Pulley Shaft
Rotating Floor Brush bristles worn
Rotating Floor Brush jammed

Air Passageway clogged

Dirt Tube is clogged

Remedies

Move Cleaning Selector to Floor setting
Move Selector to lower setting
Reset Height Adjustment
Replace with new bag
Replace Drive Belt
Reposition belt/clean brush/belt areas

Replace brush
Remove brush and clean debris from
brush ends
Remove Brush Cover.
Clean debris from passageway
Remove bolt and nut from Vacuum Body.
Use flat blade screwdriver to release
locking tab on Powerfoot from Vacuum
Body. Remove Vacuum Body and clean
obstructions from inside Powerfoot and
Vacuum Body bottom. Reassemble
following instructions on Page 4

⚠️ WARNING: To reduce the risk of injury from moving parts and/or electrical shock, turn Power Switch OFF and disconnect polarized plug from electrical outlet before performing troubleshooting checks.

Cleaning Selector won't slide.

Possible Causes

Dirt clogging slide track

Remedies

Remove Brush Cover and clean slide area

Tools won't pick up dirt.

Possible Causes

Incorrect Setting

Vacuum Hose, Wands
or Tools clogged

Remedies

Move Cleaning Selector to Tools
setting Make sure Handle is locked in
Upright Position

Visually check for objects blocking
suction path and remove carefully

Vacuum cleaner is difficult to push.

Possible Causes

Incorrect Floor Surface Selector setting

Remedies

Move Selector to next highest setting

If suggestions for this or any function of your Upright Vacuum Cleaner do not correct the problem, call:

BISSELL Consumer Services
1-800-237-7691

Monday - Friday 8 a.m. — 7 p.m. EST
Saturday 9 a.m. — 2 p.m. EST

How to use your BISSELL® Upright Vacuum Cleaner

Handle Positions

Press the Handle Release Pedal with your foot to place your Upright into one of three cleaning positions.

- 1.** Upright - For storage and above floor cleaning with special tools.
- 2.** Normal Cleaning - Use for most household floor cleaning tasks.
- 3.** Low Cleaning - Use for vacuuming under low furniture such as tables, chairs and beds.

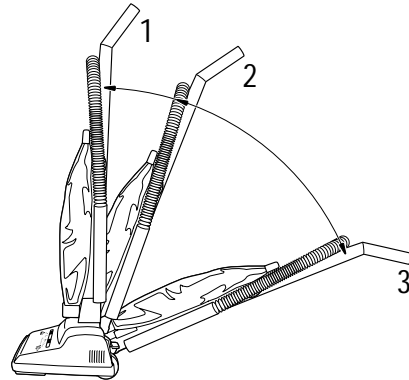

Powerfoot/Height Adjustment

The Powerfoot/Rotating Floor Brush on your BISSELL® Upright Vacuum can be adjusted to clean several floor surfaces.

NOTE: For optimal cleaning performance, adjust to the lowest practical setting. If your cleaner is difficult to push, adjust to the next higher setting.

- 1.** Place Handle in Upright Position
- 2.** Slide Floor Surface Selector to desired setting.
 - Highest setting - For plush pile carpet.
 - Medium settings - For short pile carpets.
 - Lowest setting - For bare floors.
- 3.** Place the Handle into the Normal Cleaning position and the Powerfoot will adjust to the setting chosen.

Note: You may also adjust the setting while in the Normal Cleaning Position.

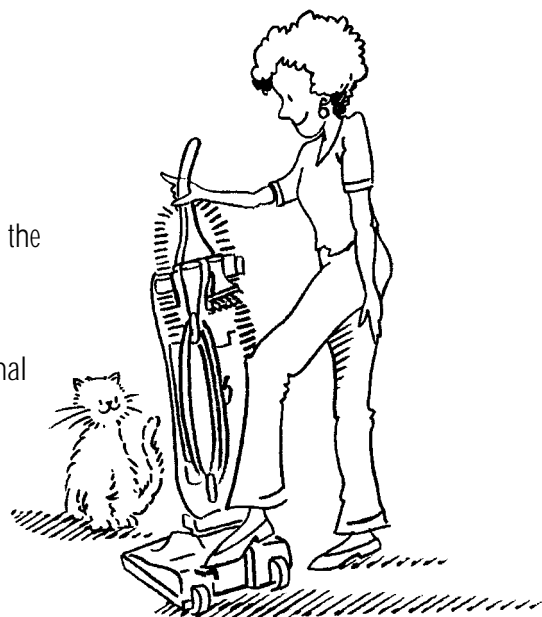
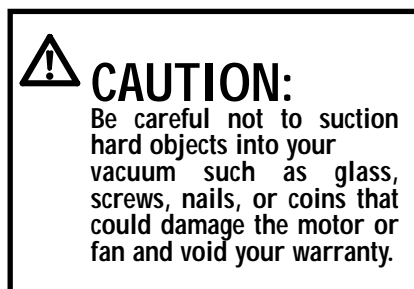

Replace Lightbulb

Replacement Bulb

Use only BISSELL® Replacement Bulb (#5559069) in your Upright Vacuum Cleaner.

1. Unplug unit from electrical outlet.
2. Remove Cleaning Selector and Floor Surface Selector Knobs by grasping knobs firmly and pulling straight up. Remove Vacuum Hose from Hose Port by turning counterclockwise and lifting up.
3. Place Handle in Low position and turn vacuum cleaner face down on floor.
4. Insert a blade type screwdriver into four slots on Powerfoot and pry outward on sides of Top Cover to unsnap internal latches.
5. Turn vacuum cleaner face up on floor and lift Top Cover from Powerfoot.
6. Grasp bulb with fingers and gently work from side to side while pulling up. Do not squeeze bulb too firmly or it may break and injure you.
7. Insert new bulb, pushing gently until is firmly seated in socket.
8. Realign Top Cover to Powerfoot and press downward until you hear all four internal latches snap into place. Test Top Cover for tightness by pulling up on it.
9. Press Selector Knobs onto prongs on Powerfoot.

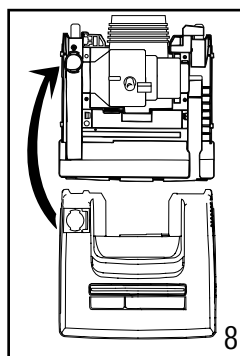
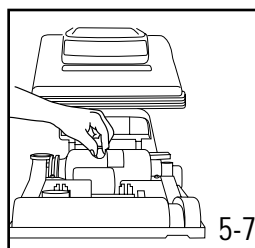
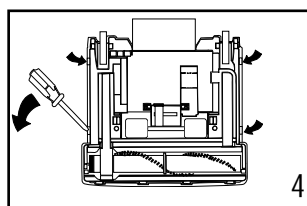
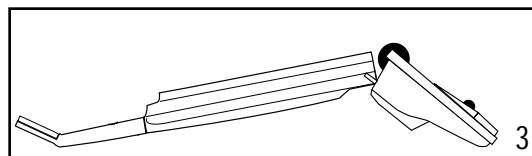

Special Tools

Your Upright Vacuum Cleaner is not only a powerful carpet, bare floor, and rug vacuum cleaner, it's also a versatile above floor vacuum cleaner when you select one of the three special on board tools stored on the Tool Rack.

1. Raise Handle to Upright Position.
2. Make sure Vacuum Hose is securely inserted in Hose Port (turn clockwise to lock).
3. Slide Cleaning Selector to Tool setting to divert all suction to Hose.
4. Attach tools by firmly pushing/twisting onto Vacuum Hose or Wand.

- Dusting Brush - Slide onto Upholstery tool as shown. For dusting surfaces such as table tops, mantles, lamp shades, drapes, woodwork, etc.
- Upholstery Tool - Use with or without Dusting Brush for upholstery or stairs.
- Extension Wand-
For extra length or reach. Use with one of the two other tools.
- Crevice tool -
For tight, narrow spaces.

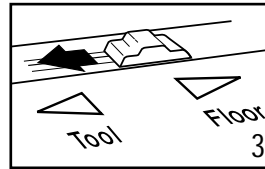
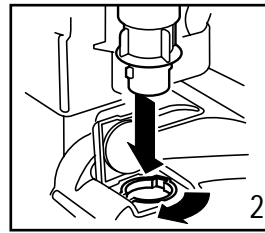

Tip:

Hair, string and small objects can block the Vacuum Hose or Tools. Check them occasionally for obstructions. See Troubleshooting Guide for instructions.

Upholstery Tool

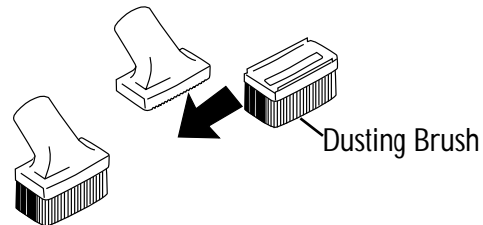

To Resume Normal Floor Vacuuming

1. Slide Cleaning Selector to Floor to divert the suction back to the Powerfoot.
2. Vacuum Hose must be left in place. For maximum cleaning performance.

⚠ WARNING: The Rotating Floor Brush continues to rotate while tools are in use. To reduce the risk of injury from moving parts, always move the cleaner using the handle. Always place vacuum cleaner on floor with Handle in Upright position when using tools. Never place your fingers under the cleaner when it is running. Never place Powerfoot on furniture, or place vacuum cleaner close enough to objects to pull them into rotating brush.

- 4.** Grasp Rotating Floor Brush at both ends and lift up. Clean strings, hair and other debris from Rotating Floor Brush, paying particular attention to brush ends.
- 5.** Clean strings, hair and other debris from Motor Pulley and Drive Belt areas. Inspect entire Drive Belt carefully for wear, cuts or stressed areas.
- 6.** Check Air Passageway for obstructions. Remove debris from this area.
- 7.** Reassemble unit (see steps 4-6 below).

Tip:

This is a good time to clean the Slide Track area of hair, string, dirt, or other obstructions.

Replace Drive Belt

Replacement Belts

Use only BISSELL® Replacement Belt Style 2 (#32015) in your Upright Vacuum Cleaner.

- 1.** Unplug unit from electrical outlet.
- 2.** With Rotating Floor Brush removed (steps 1-5 above) from vacuum cleaner, stretch old belt to clear Motor Pulley, and remove belt. Discard.
- 3.** Place new Drive Belt over Motor Pulley and stretch other end over crown of Rotating Floor Brush.
- 4.** Place belt end of Rotating Floor Brush into its slot and hold it in place with your left hand, while slowly pulling opposite end of brush down into its slots with your right hand
- 5.** Turn Rotating Floor Brush by hand several times in direction of Motor Pulley. If properly installed, Drive Belt will center itself on Rotating Brush crown.
- 6.** Position Brush Cover Tabs in the four Brush Cover slots along front of Powerfoot, and snap Brush Cover into place.

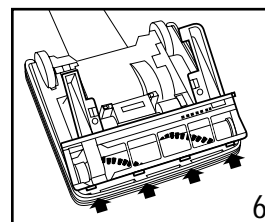
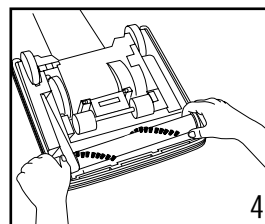
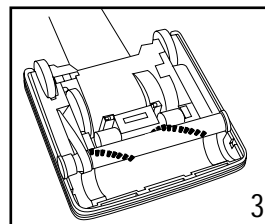

Power Cord Storage

1. Turn vacuum cleaner off.
2. Unplug Power Cord by grasping the polarized plug (NOT the cord) and disconnect from outlet.
3. Loop Power Cord around Cord Wraps on back of vacuum cleaner.
4. Clip molded plug to Power Cord to secure.

Routine Maintenance

All Models

To maintain maximum performance from your BISSELL® Upright Vacuum Cleaner, perform these simple maintenance checks at least once a month.

Replacement Parts

You may purchase replacement parts from your retailer, or by using the order form in this User's Guide. To locate a retailer near you, or to place an order using Visa, Mastercard, Discover or American Express, call

BISSELL Consumer Services
1-800-237-7691

Monday - Friday 8 a.m. — 7 p.m. EST

Saturday 9 a.m. — 2 p.m. EST

Or visit our Website - www.bissell.com



WARNING: To reduce the risk of electric shock, turn Power Switch OFF and disconnect polarized plug from electrical outlet before performing maintenance or troubleshooting checks.

Replace Dust Bag

Use only BISSELL® Style 2 Dust Bags in your Upright Vacuum Cleaner. To maintain peak vacuum efficiency, you should check the Dust Bag weekly, and replace it when it is no more than half full.

Never reuse a paper Dust Bag.

1. Unplug cleaner from electrical outlet
2. Unzip Cloth Bag.
3. Grasp paper Dust Bag and Bag Collar, pull used Dust Bag from Connector Tube, and dispose of Dust Bag.
4. Fold down top of new Dust Bag.
5. Grasp Bag Collar and push Collar firmly over raised rib on Connector Tube. Pushing too hard on the Collar may rip the Dust Bag.
6. Tuck remainder of Dust Bag completely into vacuum cleaner. Lay it flat, top to bottom, without bunching.
7. Zip Cloth Bag closed.

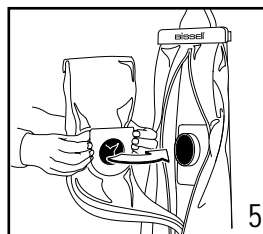

Check Rotating Brush and Drive Belt

You should check your vacuum cleaner's Drive Belt and Rotating Floor Brush regularly for wear or damage. You should also clean the brush and brush ends of string, hair, and carpet fibers. These can wrap around the brush and hamper its ability to effectively clean your carpet.

1. Unplug unit from electrical outlet.
2. Place Handle in Low Cleaning position and turn vacuum cleaner face down on floor.
3. Locate two Lock Tabs adjacent to forward wheels on removable Brush Cover. Using your fingers, press outward on each Lock Tab separately to remove Brush Cover.

