

This Owner's Manual is provided and hosted by Appliance Factory Parts.

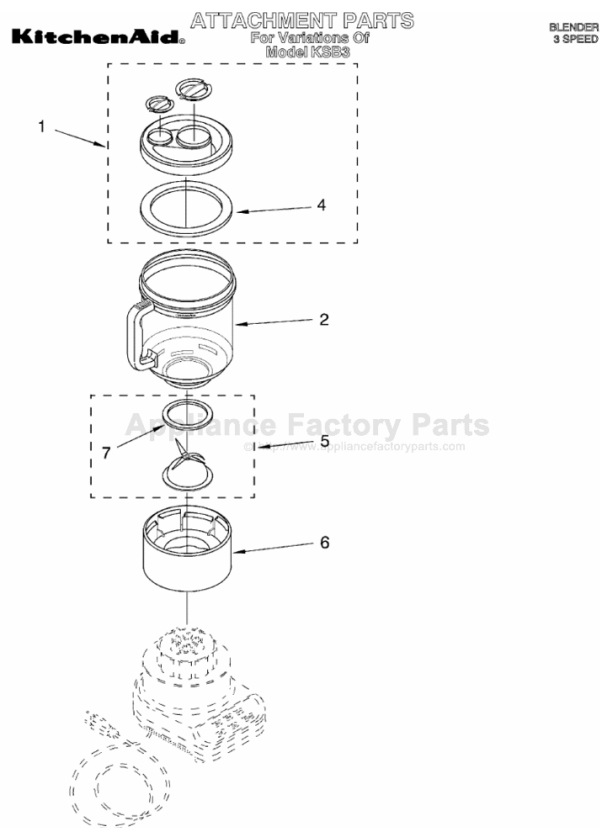

KITCHENAID KSB3AC0 Owner's Manual

[Shop genuine replacement parts for KITCHENAID
KSB3AC0](#)



[Find Your KITCHENAID Small Appliance Parts - Select From 538 Models](#)

----- Manual continues below -----

KitchenAid®



3 SPEED CLASSIC BLENDER INSTRUCTIONS



1-800-541-6390
Details Inside



FOR THE WAY IT'S MADE.™

Hassle-Free Replacement Warranty



We're so confident the quality of our products meets the exacting standards of KitchenAid that, if your blender should fail within the first year of ownership, KitchenAid will arrange to deliver an identical or comparable replacement to your door free of charge and arrange to have your "failed" blender returned to us. Your replacement unit will also be covered by our one year full warranty. Please follow these instructions to receive this quality service.

If you reside in the 50 United States and your KitchenAid® blender should fail within the first year of ownership, simply call our toll-free Customer Satisfaction Center at **1-800-541-6390**, 8 a.m. to 8 p.m., Monday through Friday, 10 a.m. to 5 p.m., Saturday, Eastern Time. Give the consultant your complete shipping address. (No P.O. Box Numbers, please.)

When you receive your replacement blender, use the carton and packing materials to pack-up your "failed" blender. In the carton, include your name and address on a sheet of paper along with a copy of the proof of purchase (register receipt, credit card charge slip, etc.).

For a detailed explanation of warranty terms and conditions, including how to arrange for service outside the United States, see pages 3 and 4.

Proof of Purchase & Product Registration

Always keep a copy of the sales receipt showing the date of purchase of your blender. Proof of purchase will assure you of in-warranty service.

Before you use your blender, please fill out and mail your product registration card packed with the unit. This card will enable us to contact you in the unlikely event of a

product safety notification and assist us in complying with the provisions of the Consumer Product Safety Act. This care does not verify your warranty.

Please complete the following for your personal records:

Model Number _____

Serial Number _____

Date Purchased _____

Store Name _____

Table of Contents

Hassle-Free Replacement Warranty.....	Inside Front Cover
Product Registration Card	Inside Front Cover
Important Safeguards.....	2
Warranty	3
For the 50 United States and District of Columbia.....	3
For Puerto Rico	4
Arranging for Service after the Warranty Expires	4
Arranging for Service Outside the 50 United States and Puerto Rico	4
Ordering Accessories and Replacement Parts	4
Electrical Requirements.....	5
Troubleshooting Problems	5
Blender Features	6
Assembling Your Blender	7
To Operate Your Blender	9
Speed Control Guide	11
Care and Cleaning	11
Blender Tips.....	12

NOTE: DUE TO THE UNIQUE CONTAINER AND BLADE DESIGN, READ THESE INSTRUCTIONS AND RECIPES BEFORE USING YOUR NEW KITCHENAID® BLENDER TO ACHIEVE MAXIMUM PERFORMANCE RESULTS.

Your safety and the safety of others are very important.

We have provided many important safety messages in this manual and on your appliance. Always read and obey all safety messages.



This is the safety alert symbol.

This symbol alerts you to potential hazards that can kill or hurt you and others.

All safety messages will follow the safety alert symbol and either the word "DANGER" or "WARNING." These words mean:



You can be killed or seriously injured if you don't immediately follow instructions.



You can be killed or seriously injured if you don't follow instructions.

All safety messages will tell you what the potential hazard is, tell you how to reduce the chance of injury, and tell you what can happen if the instructions are not followed.

IMPORTANT SAFEGUARDS

When using electrical appliances, basic safety precautions should always be followed to reduce the risk of fire, electric shock, and/or injury to persons including the following:

1. Read all instructions.
2. To protect against risk of electrical shock, do not put blender in water or other liquid.
3. Close supervision is necessary when any appliance is used by or near children.
4. Unplug from outlet when not in use, before putting on or taking off parts, and before cleaning.
5. Avoid contact with moving parts.
6. Do not operate the blender with a damaged cord or plug or after appliance malfunctions, or is dropped or damaged in any manner. Return appliance to the nearest Authorized Service Center for examination, repair or electrical or mechanical adjustment.
7. Do not use outdoors.
8. Do not let cord hang over edge of table or counter.
9. Keep hands and utensils out of container while blending to reduce the risk of severe injury to persons or damage to the blender. A scraper may be used but must be used only when the blender is not running.
10. Blades are sharp. Handle carefully.
11. To reduce the risk of injury, never place the cutter-assembly blades on base without jar properly attached.
12. Always operate blender with cover in place.
13. The use of attachments, including canning jars, not recommended by KitchenAid may cause a risk of injury to persons.
14. When blending hot liquids, remove center piece of two-piece cover.
15. This product is designed for household use only.

SAVE THESE INSTRUCTIONS

KitchenAid® Blender Warranty for the 50 United States and District of Columbia

This warranty extends to the purchaser and any succeeding owner for blenders operated in the 50 United States and District of Columbia.

Length of Warranty:	KitchenAid Will Pay For Your Choice of:	KitchenAid Will Not Pay For:
<p>One Year Full Warranty from date of purchase.</p>	 <p>Hassle-Free Replacement of your blender. See inside front cover for details on how to arrange for service, or call the Customer Satisfaction Center toll-free at 1-800-541-6390. OR The replacement parts and repair labor costs to correct defects in materials and workmanship. Service must be provided by an Authorized KitchenAid Service Center. See the KitchenAid® blender Warranty for Puerto Rico on page 4 for details on how to arrange for service.</p>	<p>A. Repairs when blender is used in other than normal single family home use. B. Damage resulting from accident, alteration, misuse or abuse. C. Any shipping or handling costs to deliver your blender to an Authorized Service Center. D. Replacement parts or repair labor costs for blenders operated outside the 50 United States and District of Columbia.</p>

KITCHENAID DOES NOT ASSUME ANY RESPONSIBILITY FOR INCIDENTAL OR CONSEQUENTIAL DAMAGES. Some states do not allow the exclusion or limitation of incidental or consequential damages, so this exclusion may not apply to you. This warranty gives you specific legal rights and you may also have other rights which vary from state to state.

KitchenAid® Blender Warranty for Puerto Rico

A limited one year warranty extends to the purchaser and any succeeding owner for blenders operated in Puerto Rico. During the warranty period, all service **must** be handled by an Authorized KitchenAid Service Center. Please bring the blender, or ship it

prepaid and insured, to the nearest Authorized Service Center. Call toll-free **1-800-541-6390** to learn the location of a Service Center near you. Your repaired blender will be returned to you prepaid and insured.

Arranging for Service after the Warranty Expires

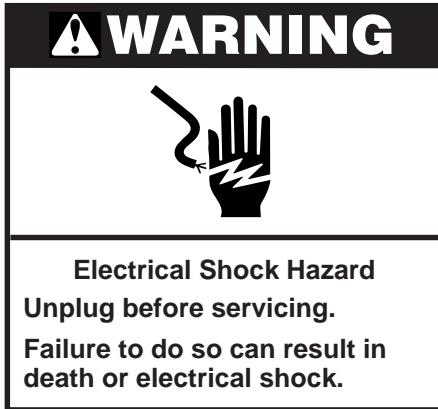

For service information, call toll-free 1-800-541-6390 or write to:
Customer Satisfaction Center,
KitchenAid Portable Appliances, P.O.
Box 218, St. Joseph, MI 49085-0218.

Arranging for Service Outside the United States and Puerto Rico

Consult your local KitchenAid dealer or the store where you purchased the

blender for information on how to obtain service.

Ordering Accessories and Replacement Parts

To order accessories or replacement parts for your blender, call toll-free 1-800-541-6390 or write to:

Customer Satisfaction Center,
KitchenAid Portable Appliances, P.O.
Box 218, St. Joseph, MI 49085-0218.

Electrical Requirements

Volts: 120 A.C. only.
Hertz: 60
Grounding, 3-prong system.
15-amp branch circuit.

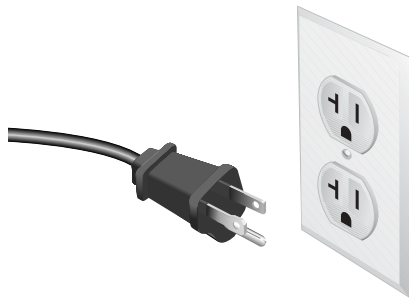

NOTE: Your blender has a 3-prong grounded plug. To reduce the risk of electrical shock, this plug will fit in an outlet only one way. If the plug does not fit in the outlet, contact a qualified electrician. Do not modify the plug in any way.

A short power-supply cord is provided to reduce risks resulting from becoming entangled in or tripping over a longer cord.

Longer extension cords are available and may be used if care is exercised in their use.

If a long extension cord is used,

- the marked electrical rating of the extension cord should be at least as great as the electrical rating of the appliance,
- the extension cord should be a grounding-type 3-wire cord.

Troubleshooting Problems

If your blender should malfunction or fail to operate, please check the following:

1. Is the blender plugged in?
2. Is the fuse in the circuit to the blender in working order? If you have a circuit breaker box, be sure the circuit is closed.
3. Try unplugging and waiting 15-20 minutes before re-plugging the blender.

If the problem cannot be corrected with the above steps, see the KitchenAid Warranty on page 3. DO NOT return the mixer to the retailer – they do not provide service.

Blender Features

This blender was built and tested to KitchenAid quality standards for optimum performance and long, trouble-free life.

Textured, Durable Jar Lid with Clear, 2 Ounce Ingredient Cap

provides a strong seal, hides fingerprints. The lid will become more flexible with use, however it will maintain its tight seal throughout the life of the blender.

Wide Pour Spout for smooth, drip free pouring.

Sturdy, Heat-Resistant Glass Blender Jar with smooth, rounded sides for easy scraping and removal of foods.

Stainless Steel Blade Assembly features blending blades, on 4 different planes for optimal blending, made of superior grade stainless steel.

Textured Threaded Collar for jar stability, hides fingerprints.

Sealing Ring

No-Slip Rubber Feet ensures operating stability even when jar is filled to capacity.

Classic Base with three-speed blending capability, Step Start® and Pulse features. The smooth, rounded metal base is sturdy, easy to clean and has built-in cord storage.

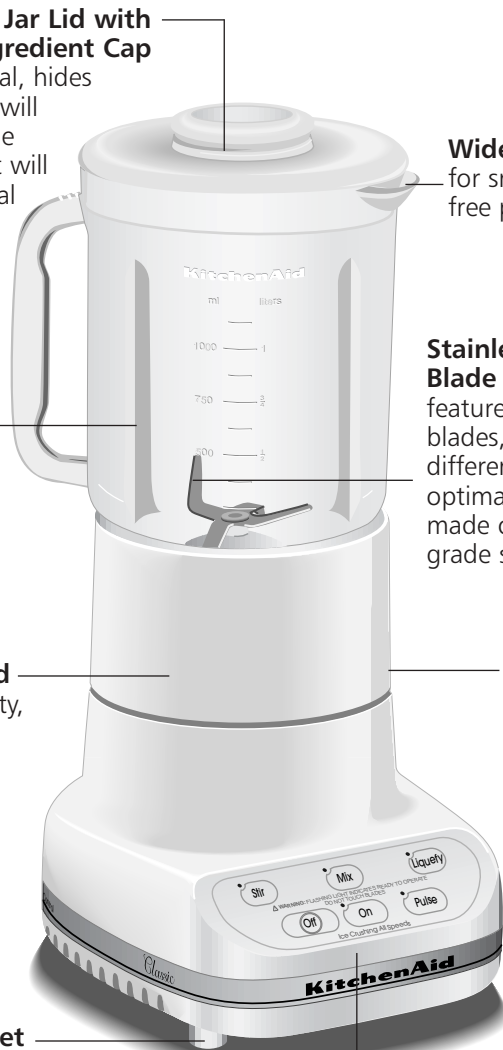

Assembling Your Blender

⚠ WARNING



Electrical Shock Hazard
Do not put in water.
Failure to do so can result in death or electrical shock.

1. Before assembling your blender wipe blender base with a warm sudsy cloth, then wipe clean with a damp cloth. Dry with a soft cloth. Wash blender jar, lid, collar and blades in warm, sudsy water. Rinse and wipe parts dry.
2. Turn blender jar upside down. Place the small sealing ring on the blade assembly.



3. Place the blade assembly with the sealing ring in the bottom opening of the jar.



4. Twist collar onto jar. Be sure to engage threads properly and securely. Turn assembled jar right side up.

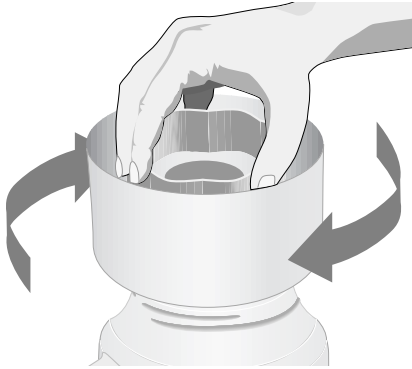

5. Place lid onto blender jar.



Assembling Your Blender

6. Coil the power cord into the storage area on the bottom of the power base to shorten.



7. Place jar on power base.



⚠ WARNING



Electrical Shock Hazard
Plug into a grounded 3 prong outlet.
Do not remove ground prong.
Do not use an adapter.
Failure to follow these instructions can result in death, fire or electrical shock.

8. Plug power cord into a grounded 3-prong outlet. Blender is now ready to use.
9. Before removing the jar from the base after use, always push the OFF pad and make sure the blinking red light is off, then unplug. Lift the jar straight up, with the collar attached, do not twist. Do not unscrew the glass jar from the collar until you are ready to remove the blade assembly. Loosening the collar with liquids inside the jar will cause them to leak out.



To Operate Your Blender

NOTE: While red indicator light is blinking or blender is on:

- Do not touch blades.
- Do not interfere with blade movement.
- Do not remove blender jar lid.
- With red light flashing, an accidental touching of a speed pad, or other circumstances may result in turning on the blender.
- If blender runs when ON light is flashing, do not use. Take unit to an Authorized Service Center. (However a slight flicker is normal.)
- This unit should operate only when a speed pad is pressed. Immediately press the OFF pad if the unit runs at any other time. If this occurs, do not use; take the unit to an Authorized Service Center.

The KitchenAid® Classic blender has three speeds: Stir, Mix and Liquefy.



- Before operating the blender, make sure the blender jar is properly assembled (see page 7) and in place on the blender base. Put ingredients in jar and firmly attach lid.
- Press the ON pad. The red indicator light should blink on and off indicating the speed pads are activated.



NOTE: If the red indicator light is not blinking at this time, unplug blender and take unit to an Authorized Service Center.

- Press the desired speed pad for continuous operation at that speed. The indicator light will glow and the red light will stay on. You may change speeds without stopping the unit by pushing the new speed pad.
- If blending warm foods or liquids, place a cloth over the blender lid and operate only on STIR speed. Do not place bare hand over blender lid.



- To turn the blender off, press the OFF pad. The OFF pad will stop any speed and deactivate the blender at the same time. Before removing the blender jar, deactivate the blender by pressing the OFF pad and unplugging the power cord.

NOTE: Do not overprocess foods. Stop and check the consistency of foods after a few seconds.

To Operate Your Blender

Ingredient Cap

Remove cap and add ingredients at STIR or MIX speeds. When operating at higher speeds, with a full jar or with hot contents, stop blender and add ingredients.



Step Start® Feature

Step Start® feature automatically starts the blender at a lower speed to prevent splattering then quickly increases to the selected speed for optimal performance.

Pulse Feature

Your KitchenAid® blender has a “Pulse At Any Speed” feature.

- Before operating the blender, make sure the jar is properly assembled (see page 7) and in place on the blender base. Put ingredients into blender jar and attach lid firmly.
- Press the ON pad. The red indicator light should be blinking, showing that the blender is activated.
- Press the PULSE pad. The indicator light above the pad will glow, indicating that all the speed pads are in the Pulse mode.



- Select a speed pad and press for the desired length of time (a short delay reaching the selected speed is normal due to the Step Start® feature).
- To turn the Pulse feature off, just press the PULSE pad again. The blender is now ready for continuous operation. Before removing the blender jar, deactivate the blender by pressing the OFF pad and unplugging the power cord.



NOTE: Use a rubber spatula to mix ingredients ONLY when the blender is OFF and unplugged. Never use any utensil, including spatulas, in the blender jar while the motor is running.

Speed Control Guide

Item	Speed	Item	Speed
Pancake batter	Mix	Grated hard cheese	Liquefy
Waffle batter	Mix	Gravy	Mix
Cheesecake	Liquefy	White sauce	Stir
Mousse	Liquefy	Smooth ricotta or cottage cheese	Mix
Streusel topping	Stir	Fruit juice from frozen concentrate	Mix
Sweet crumb topping	Stir	Chopped vegetables	Stir
Fruit-based drink	Liquefy	Chopped fruit	Pulse/Stir
Frozen yogurt-based drink	Liquefy	Chopped ice	Stir
Sherbet-based drink	Liquefy	Crushed ice	Stir
Ice cream/Frozen yogurt- based drink	Liquefy		

Tip - Ice can be crushed at any speed. Process up to one standard ice cube tray or 12 to 14 standard ice cubes at a time. No liquid needs to be added for processing, occasional stirring with spatula will be helpful. When using higher speeds, pulse may give better results.

Care and Cleaning

1. Disassemble blender container parts and wash in warm, sudsy water. Rinse all parts and wipe dry. Or, wash in automatic dishwasher.
 2. For complete cleaning, remove gasket from blade assembly, wash in warm, soapy water.
 3. Wipe cord with warm, sudsy cloth; wipe clean with a damp cloth, then dry with a soft cloth. Cord can be coiled into the storage area on the bottom of the power base for neat and convenient storage.
- NOTE:** Always correctly assemble clean blender parts before storing on blender base.

Blender Tips

Quick Tips

- Use the pulse feature when making beverages that include ice cubes in order to produce a smoother texture.
- Blend at LIQUEFY if you're making a large amount of beverage using lots of ice. For smaller quantities, use MIX.
- Smaller ice cubes can be chopped or crushed faster than large ones.
- Add food to this blender jar in larger quantities than you would with other blenders – you can add 2 to 3 cups at a time versus 1-cup portions.
- For many ingredient mixtures, start the blending process at STIR to combine the ingredients thoroughly. Then increase to a higher speed, if necessary.
- Be sure to keep cover on blender jar while blending.
- If desired, remove center cap of blender jar cover to add liquids or ice cubes while the blender is operating at STIR or MIX speeds. When operating at higher speeds, with a full jar or with hot contents stop blender and add ingredients.
- Stop the blender and unplug before using utensils in the blender jar.
- Cool hot foods, if possible, before blending. Begin blending warm foods at STIR. Increase to higher speed, if necessary.
- Place a cloth over the lid and your hand on the cloth when blending warm or hot liquids and operate only on STIR. Do not place bare hand on blender lid when processing hot liquids.

How To ...

Reconstitute frozen juice: For a 6-oz. can of orange juice concentrate, combine the juice and correct amount of water in the blender jar. Cover and blend at MIX until thoroughly combined, about 10 to 15 seconds.

For a 12-oz. can, combine the juice and 1 can of water in the blender jar. Cover and blend at MIX until thoroughly combined, about 20 to 30 seconds. Stir in remaining 2 cans of water.

Dissolve flavored gelatin: Pour boiling water into the blender jar. Place cloth over lid, hold firmly and blend at MIX until gelatin is dissolved, about 30 to 60 seconds. Add other ingredients.

Make cookie and graham cracker crumbs: Break larger cookies into pieces about 1½ inches in diameter. Use smaller cookies as is. Place in blender jar. Cover and blend at STIR, pulsing a few times, about 3 seconds each time, until desired consistency is reached. Use the crumbs to make a quick topping for frozen yogurt, pudding, or a fruit compote.

To make a finer crumb for pie and dessert crusts, break graham crackers or cookies into pieces about 1½ inches in diameter. Place in the blender jar. Cover and blend at LIQUEFY, pulsing a few times until desired consistency is reached, about 20 to 30 seconds.

Make cracker crumbs: Follow procedure for cookies. Use to top or as an ingredient in main dish casseroles and vegetable dishes.

Make bread crumbs: Tear bread into pieces about 1½ inches in diameter. Follow procedure for crackers. Use in same ways you would use cracker crumbs.

Blender Tips

How To ...

Chop fruits and vegetables: Put 2 cups of fruit or vegetable chunks in blender jar. Cover and blend at STIR, pulsing a few times, about 2 to 3 seconds each time, until desired consistency is reached.

Puree fruits: Place 2 cups canned or cooked fruit in blender jar. Add 2 to 4 tablespoons fruit juice or water per cup of fruit. Cover and blend at MIX about 5 to 10 seconds.

Puree vegetables: Place 2 cups canned or cooked vegetables in blender jar. Add 2 to 4 tablespoons broth, water, or milk per cup of vegetables. Cover and blend at MIX about 10 to 20 seconds.

Puree meats: Place cooked, cubed, tender meat in blender jar. Add 2 to 4 tablespoons broth, water, or milk per cup of meat. Cover and blend on STIR 10 seconds. Stop and scrape sides of blender jar. Cover and blend on MIX 10 to 20 seconds longer.

Puree cottage cheese or ricotta cheese: Place cottage cheese or ricotta cheese in blender jar. Cover and blend at MIX until smooth, about 25 to 35 seconds. If necessary, add 1 tablespoon skim milk per cup of cottage cheese. Use as a base for lowfat dips and spreads.

Combine liquid ingredients for baked goods: Pour liquid ingredients in blender jar. Cover and blend at LIQUEFY until well mixed, about 1 minute. Pour liquid mixture over dry ingredients and stir well.

Take lumps out of gravy: If sauce or gravy becomes lumpy, place in blender jar. Cover and blend at MIX until smooth, about 5 to 10 seconds.

Combine flour and liquid for thickening: Place flour and liquid in blender jar. Cover and blend at STIR until smooth, about 5 to 10 seconds.

Prepare white sauce: Place milk, flour, and salt, if desired, in blender jar. Cover and blend at STIR until well mixed, about 5 to 10 seconds. Pour into saucepan and cook as usual.

Prepare pancake or waffle batter from mix: Place mix and other ingredients in blender jar. Cover and blend at MIX until well mixed, 10 to 20 seconds; scrape sides of blender jar, if necessary.

Grate cheese: Cut very cold cheese into ½- to 1-inch cubes. Place up to ½ cup cheese in the blender jar. Cover and blend at LIQUEFY about 5 to 10 seconds. For hard cheeses, such as Parmesan, bring to room temperature, then blend at LIQUEFY for 10 to 15 seconds.

Make oatmeal for a baby: Place uncooked rolled oats in blender jar. Blend at MIX until desired consistency, using pulse button, about 5 to 10 seconds. Cook as usual.

Make baby food from adult food: Place prepared adult food in blender jar. Cover and blend at STIR about 10 seconds. Then blend at MIX about 10 to 30 seconds.

Rinse your blender jar: Fill blender jar one-third to one-half full with warm water. Add a few drops of liquid dish detergent. Cover and blend at STIR until sides are clean, about 5 to 10 seconds. Rinse and dry. For complete cleaning, wash all gaskets separately.



FOR THE WAY IT'S MADE.™

® Registered Trademark/™ Trademark of KitchenAid, U.S.A.