

This Owner's Manual is provided and hosted by [Appliance Factory Parts](#).

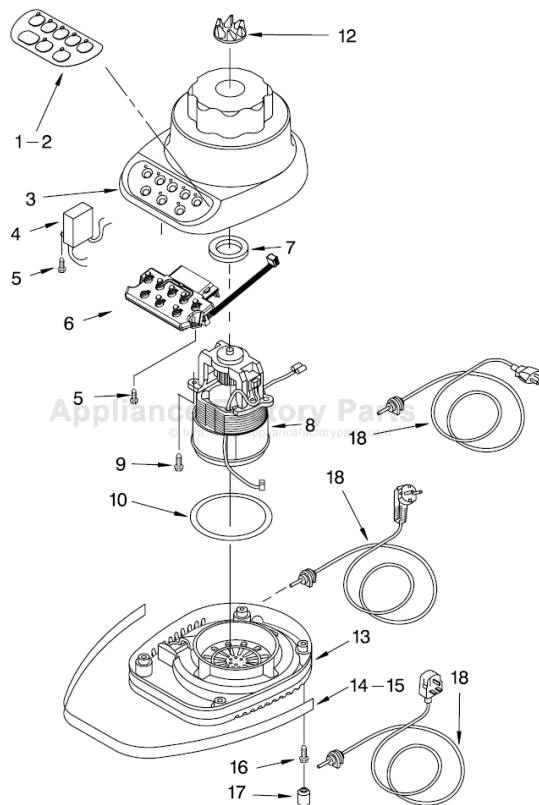

KITCHENAID KSB5SSBK4 Owner's Manual

[Shop genuine replacement parts for KITCHENAID
KSB5SSBK4](#)



[Find Your KITCHENAID Small Appliance Parts - Select From 538 Models](#)

----- Manual continues below -----

KitchenAid®



5 SPEED PROFESSIONAL BLENDER

INSTRUCTIONS AND RECIPES



1-800-541-6390
Details Inside



FOR THE WAY IT'S MADE.™

Hassle-Free Replacement Warranty



We're so confident the quality of our products meets the exacting standards of KitchenAid that, if your blender should fail

within the first year of ownership, KitchenAid will arrange to deliver an identical or comparable replacement to your door free of charge and arrange to have your "failed" blender returned to us. Your replacement unit will also be covered by our one year full warranty. Please follow these instructions to receive this quality service.

If you reside in the 50 United States and your KitchenAid® blender should fail within the first year of ownership, simply call our toll-free Customer Satisfaction Center at **1-800-541-6390**, 8 a.m. to 8 p.m., Monday through Friday, 10 a.m. to 5 p.m., Saturday, Eastern Time. Give the consultant your complete shipping address. (No P.O. Box Numbers, please.)

When you receive your replacement blender, use the carton and packing materials to pack-up your "failed" blender. In the carton, include your name and address on a sheet of paper along with a copy of the proof of purchase (register receipt, credit card charge slip, etc.).

For a detailed explanation of warranty terms and conditions, including how to arrange for service outside the United States, see pages 3 and 4.

Proof of Purchase & Product Registration

Always keep a copy of the sales receipt showing the date of purchase of your blender. Proof of purchase will assure you of in-warranty service.

Before you use your blender, please fill out and mail your product registration card packed with the unit. This card will enable us to contact you in the unlikely event of a

product safety notification and assist us in complying with the provisions of the Consumer Product Safety Act. This card does not verify your warranty.

Please complete the following for your personal records:

Model Number _____

Serial Number _____

Date Purchased _____

Store Name _____

Table of Contents

Hassle-Free Replacement Warranty.....	Inside Front Cover
Product Registration Card	Inside Front Cover
Important Safeguards.....	2
Warranty	3
For the 50 United States and District of Columbia.....	3
For Puerto Rico	4
Arranging for Service after the Warranty Expires	4
Arranging for Service Outside the 50 United States and Puerto Rico	4
Ordering Accessories and Replacement Parts	4
Electrical Requirements.....	5
Troubleshooting Problems	5
Blender Features	6
Assembling Your Blender	7
To Operate Your Blender	9
Speed Control Guide	11
Care and Cleaning	11
Blender Tips.....	12
Recipes	14
Cocktails	14
Appetizers, Dips and Spreads.....	16
Cold Soups	19
Pancakes and Waffles	22
Baby Food.....	26
Sauces and Dressings.....	28
Sandwich Fillings.....	31
Pesto, Toppings and Crunches	33
Energy Drinks.....	36
Dessert Drinks	38
Desserts	41

NOTE: DUE TO THE UNIQUE CONTAINER AND BLADE DESIGN, READ THESE INSTRUCTIONS AND RECIPES BEFORE USING YOUR NEW KITCHENAID® BLENDER TO ACHIEVE MAXIMUM PERFORMANCE RESULTS.

Your safety and the safety of others are very important.

We have provided many important safety messages in this manual and on your appliance. Always read and obey all safety messages.



This is the safety alert symbol.

This symbol alerts you to potential hazards that can kill or hurt you and others.

All safety messages will follow the safety alert symbol and either the word "DANGER" or "WARNING." These words mean:



You can be killed or seriously injured if you don't immediately follow instructions.



You can be killed or seriously injured if you don't follow instructions.

All safety messages will tell you what the potential hazard is, tell you how to reduce the chance of injury, and tell you what can happen if the instructions are not followed.

IMPORTANT SAFEGUARDS

When using electrical appliances, basic safety precautions should always be followed to reduce the risk of fire, electric shock, and/or injury to persons including the following:

1. Read all instructions.
2. To protect against risk of electrical shock, do not put blender in water or other liquid.
3. Close supervision is necessary when any appliance is used by or near children.
4. Unplug from outlet when not in use, before putting on or taking off parts, and before cleaning.
5. Avoid contact with moving parts.
6. Do not operate the blender with a damaged cord or plug or after appliance malfunctions, or is dropped or damaged in any manner. Return appliance to the nearest Authorized Service Center for examination, repair or electrical or mechanical adjustment.
7. Do not use outdoors.
8. Do not let cord hang over edge of table or counter.
9. Keep hands and utensils out of container while blending to reduce the risk of severe injury to persons or damage to the blender. A scraper may be used but must be used only when the blender is not running.
10. Blades are sharp. Handle carefully.
11. To reduce the risk of injury, never place the cutter-assembly blades on base without jar properly attached.
12. Always operate blender with cover in place.
13. The use of attachments, including canning jars, not recommended by KitchenAid may cause a risk of injury to persons.
14. When blending hot liquids, remove center piece of two-piece cover.
15. This product is designed for household use only.

SAVE THESE INSTRUCTIONS

KitchenAid® Blender Warranty for the 50 United States and District of Columbia

This warranty extends to the purchaser and any succeeding owner for blenders operated in the 50 United States and District of Columbia.

Length of Warranty:	KitchenAid Will Pay For Your Choice of:	KitchenAid Will Not Pay For:
<p>One Year Full Warranty from date of purchase.</p>	 <p>Hassle-Free Replacement of your blender. See inside front cover for details on how to arrange for service, or call the Customer Satisfaction Center toll-free at 1-800-541-6390. OR The replacement parts and repair labor costs to correct defects in materials and workmanship. Service must be provided by an Authorized KitchenAid Service Center. See the KitchenAid® blender Warranty for Puerto Rico on page 4 for details on how to arrange for service.</p>	<p>A. Repairs when blender is used in other than normal single family home use. B. Damage resulting from accident, alteration, misuse or abuse. C. Any shipping or handling costs to deliver your blender to an Authorized Service Center. D. Replacement parts or repair labor costs for blenders operated outside the 50 United States and District of Columbia.</p>

KITCHENAID DOES NOT ASSUME ANY RESPONSIBILITY FOR INCIDENTAL OR CONSEQUENTIAL DAMAGES. Some states do not allow the exclusion or limitation of incidental or consequential damages, so this exclusion may not apply to you. This warranty gives you specific legal rights and you may also have other rights which vary from state to state.

KitchenAid® Blender Warranty for Puerto Rico

A limited one year warranty extends to the purchaser and any succeeding owner for blenders operated in Puerto Rico. During the warranty period, all service **must** be handled by an Authorized KitchenAid Service Center. Please bring the blender, or ship it

prepaid and insured, to the nearest Authorized Service Center. Call toll-free **1-800-541-6390** to learn the location of a Service Center near you. Your repaired blender will be returned to you prepaid and insured.

Arranging for Service after the Warranty Expires



For service information, call toll-free 1-800-541-6390 or write to:
Customer Satisfaction Center,
KitchenAid Portable Appliances, P.O.
Box 218, St. Joseph, MI 49085-0218.

Arranging for Service Outside the 50 United States and Puerto Rico

Consult your local KitchenAid dealer or the store where you purchased the

blender for information on how to obtain service.

Ordering Accessories and Replacement Parts

To order accessories or replacement parts for your blender, call toll-free 1-800-541-6390 or write to:

Customer Satisfaction Center,
KitchenAid Portable Appliances, P.O.
Box 218, St. Joseph, MI 49085-0218.

Electrical Requirements

Volts: 120 A.C. only.
Hertz: 60
Grounding, 3-prong system.
15-amp branch circuit.

NOTE: Your blender has a 3-prong grounded plug. To reduce the risk of electrical shock, this plug will fit in an outlet only one way. If the plug does not fit in the outlet, contact a qualified electrician. Do not modify the plug in any way.

A short power-supply cord is provided to reduce risks resulting from becoming entangled in or tripping over a longer cord.

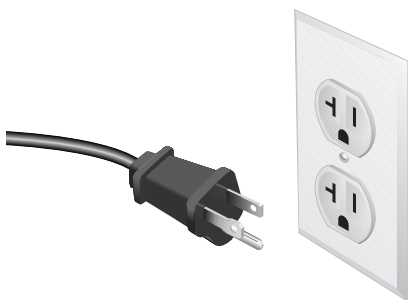

⚠ WARNING



Electrical Shock Hazard

Plug into a grounded 3 prong outlet.

Do not remove ground prong.

Do not use an adapter.

Failure to follow these instructions can result in death, fire or electrical shock.

Troubleshooting Problems

If your blender should malfunction or fail to operate, please check the following:

1. Is the blender plugged in?
2. Is the fuse in the circuit to the blender in working order? If you have a circuit breaker box, be sure the circuit is closed.

3. Try unplugging and waiting 15-20 minutes before re-plugging the blender.

If the problem cannot be corrected with the above steps, see the KitchenAid Warranty on page 3. Do not return the mixer to the retailer – they do not provide service.

Blender Features

This blender was built and tested to KitchenAid quality standards for optimum performance and long, trouble-free life.

Textured, Durable Jar Lid with Clear, 2 Ounce Ingredient Cap

provides a strong seal, hides fingerprints. The lid will become more flexible with use, however it will maintain its tight seal throughout the life of the blender.

Wide Pour Spout for smooth, drip free pouring.

Sturdy, Stainless Steel Blender Jar

with rounded sides for easy scraping and removal of foods.

Stainless Steel Blade Assembly

features blending blades, on 4 different planes for optimal blending, made of superior grade stainless steel. (not shown)

Textured Threaded Collar for jar stability, hides fingerprints.

Sealing Ring (not shown)

No-Slip Rubber Feet ensures operating stability even when jar is filled to capacity.

Professional Base with five-speed blending capability, Step Start® and Pulse features. The smooth, rounded metal base is sturdy, easy to clean and has built-in cord storage.



Assembling Your Blender

1. Before assembling your blender wipe blender base with a warm sudsy cloth, then wipe clean with a damp cloth. Dry with a soft cloth. Wash blender jar, lid, collar and blades in warm, sudsy water. To help prevent scratching, clean the stainless steel jar using a soft cloth or sponge (do not use steel wool). Rinse and wipe parts dry.
2. Turn blender jar upside down. Place the small sealing ring on the blade assembly.



3. Place the blade assembly with the sealing ring in the bottom opening of the jar.



4. Twist collar onto jar. Be sure to engage threads properly and securely. Turn assembled jar right side up.

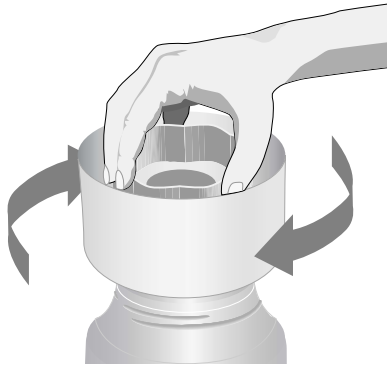

5. Place lid onto blender jar.

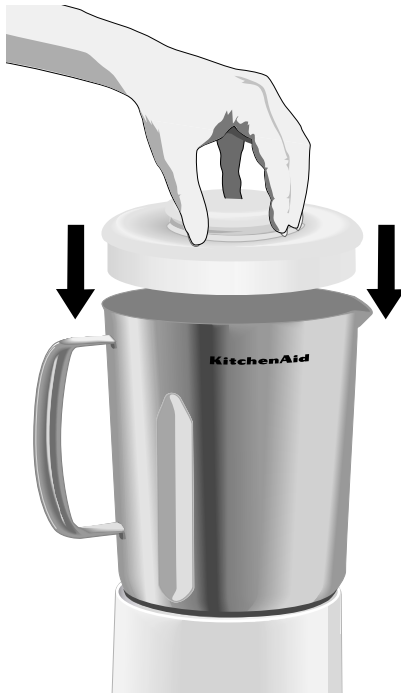



Assembling Your Blender

6. Coil the power cord into the storage area on the bottom of the power base to shorten.

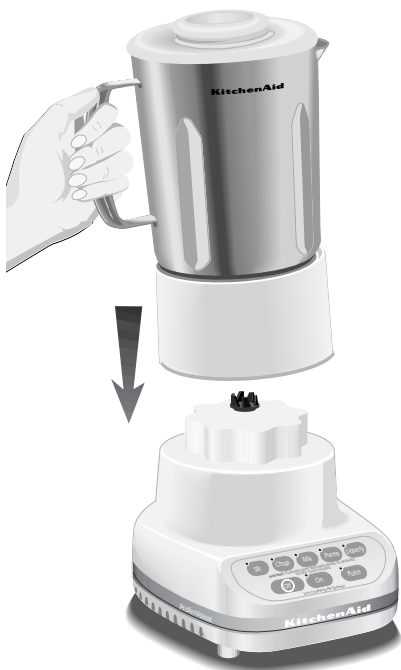

7. Place jar on power base.



 WARNING

Electrical Shock Hazard Plug into a grounded 3 prong outlet. Do not remove ground prong. Do not use an adapter. Failure to follow these instructions can result in death, fire or electrical shock.

8. Plug into a grounded 3-prong outlet. Blender is now ready to use.
9. Before removing the jar from the base after use, always push the OFF pad and make sure the blinking red light is off, then unplug. Lift the jar straight up, with the collar attached, do not twist. Do not unscrew the stainless steel jar from the collar until you are ready to remove the blade assembly. Loosening the collar with liquids inside the jar will cause them to leak out.



To Operate Your Blender

NOTE: While red indicator light is blinking or blender is on:

- Do not touch blades.
- Do not interfere with blade movement.
- Do not remove blender jar lid.
- With red light flashing, an accidental touching of a speed pad, or other circumstances may result in turning on the blender.
- If blender runs when ON light is flashing, do not use. Take unit to an Authorized Service Center. (However a slight flicker is normal.)
- This unit should operate only when a speed pad is pressed. Immediately press the OFF pad if the unit runs at any other time. If this occurs, do not use; take the unit to an Authorized Service Center.

The KitchenAid® Professional blender has five speeds: Stir, Chop, Mix, Puree and Liquefy.



- Before operating the blender, make sure the blender jar is properly assembled (see page 7) and in place on the blender base. Put ingredients in jar and firmly attach lid.
- Press the ON pad. The red indicator light should blink on and off indicating the speed pads are activated.



NOTE: If the red indicator light is not blinking at this time, unplug blender and take unit to an Authorized Service Center.

- Press the desired speed pad for continuous operation at that speed. The indicator light will glow and the red light will stay on. You may change speeds without stopping the unit by pushing the new speed pad.
- If blending warm or hot foods or liquids, remove the center ingredient cap. Operate only on STIR speed.
- To turn the blender off, press the OFF pad. The OFF pad will stop any speed and deactivate the blender at the same time. Before removing the blender jar, deactivate the blender by pressing the OFF pad and unplugging the power cord. Always lift jar with the handle.

NOTE: Do not overprocess foods. Stop and check the consistency of foods after a few seconds.

To Operate Your Blender

Ingredient Cap

Remove cap and add ingredients at STIR or MIX speeds. When operating at higher speeds, with a full jar or with hot contents, stop blender and add ingredients.



Step Start® Feature

Step Start® feature automatically starts the blender at a lower speed to prevent splattering then quickly increases to the selected speed for optimal performance.

Pulse Feature

Your KitchenAid® blender has a “Pulse At Any Speed” feature.

- Before operating the blender, make sure the jar is properly assembled (see page 7) and in place on the blender base. Put ingredients into blender jar and attach lid firmly.
- Press the ON pad. The red indicator light should be blinking, showing that the blender is activated.
- Press the PULSE pad. The indicator light above the pad will glow, indicating that all the speed pads are in the Pulse mode.



- Select a speed pad and press for the desired length of time (a short delay reaching the selected speed is normal due to the Step Start® feature).
- To turn the Pulse feature off, just press the PULSE pad again. The blender is now ready for continuous operation. Before removing the blender jar, deactivate the blender by pressing the OFF pad and unplugging the power cord.



NOTE: Use a rubber spatula to mix ingredients ONLY when the blender is OFF and unplugged. Never use any utensil, including spatulas, in the blender jar while the motor is running.

Speed Control Guide

Item	Speed	Item	Speed
Pancake batter	Mix	Sweet crumb topping	Stir
Waffle batter	Mix	Dip	Stir
Vegetable-based main dish sauce	Stir	Cream cheese-based spread	Stir
Fruit-based sauce.	Stir	Blended ice drink.	Liquefy/Chop
Salad dressing.	Mix	Fruit-based drink	Liquefy
Cream soup	Stir	Frozen yogurt-based drink . . .	Liquefy
Pureed fruit/Baby food fruit. . .	Puree	Sherbet-based drink	Liquefy
Pureed meat/Baby food meat .	Puree	Ice milk-based drink	Liquefy
Pureed vegetables/ Baby food vegetables.	Puree	Grated hard cheese	Liquefy
Meat salad for sandwich filling	Stir/Chop	Gravy	Mix
Cheesecake	Liquefy	White sauce	Stir
"Fluffy" gelatin for pie/desserts	Liquefy	Smooth ricotta or cottage cheese	Mix
Mousse	Liquefy	Oatmeal	Puree
Pesto	Stir/Chop	Fruit juice from frozen concentrate	Mix
Streusel topping	Stir	Chopped vegetables	Stir
Savory crumb topping	Chop	Chopped fruit	Pulse/Stir
Sweet crunch topping.	Chop	Chopped ice	Stir
		Crushed ice	Stir

Tip - Ice can be crushed at any speed. Process up to one standard ice cube tray or 12 to 14 standard ice cubes at a time. No liquid needs to be added for processing, occasional stirring with spatula will be helpful. When using higher speeds, pulse may give better results.

Care and Cleaning

NOTE: Do not immerse base in water.

1. Disassemble blender container parts and wash in warm, sudsy water. To help prevent scratching, clean the stainless steel jar using a soft cloth or sponge (do not use steel wool). Rinse all parts and wipe dry. Or, wash in automatic dishwasher.
2. For complete cleaning, remove gasket from blade assembly, wash in warm, soapy water.

3. Wipe cord with warm, sudsy cloth; wipe clean with a damp cloth, then dry with a soft cloth. Cord can be coiled into the storage area on the bottom of the power base for neat and convenient storage.

NOTE: Always correctly assemble clean blender parts before storing on blender base.

Blender Tips

Quick Tips

- Use the pulse feature when making beverages that include ice cubes in order to produce a smoother texture.
- Blend at LIQUEFY if you're making a large amount of beverage using lots of ice. For smaller quantities, use CHOP.
- Smaller ice cubes can be chopped or crushed faster than large ones.
- Add food to this blender jar in larger quantities than you would with other blenders – you can add 2 to 3 cups at a time versus 1-cup portions.
- For many ingredient mixtures, start the blending process at STIR to combine the ingredients thoroughly. Then increase to a higher speed, if necessary.
- Be sure to keep cover on blender jar while blending.
- If desired, remove center cap of blender jar cover to add liquids or ice cubes while the blender is operating at STIR or MIX speeds. When operating at higher speeds, with a full jar or with hot contents stop blender and add ingredients.
- Stop the blender and unplug before using utensils in the blender jar.
- Cool hot foods, if possible, before blending. Begin blending warm foods at STIR. Increase to higher speed, if necessary.
- Remove center ingredient cap when blending warm or hot liquids and operate only on STIR.

How To ...

Reconstitute frozen juice: For a 6-oz. can of orange juice concentrate, combine the juice and correct amount of water in the blender jar. Cover and blend at MIX until thoroughly combined, about 10 to 15 seconds.

For a 12-oz. can, combine the juice and 1 can of water in the blender jar. Cover and blend at MIX until thoroughly combined, about 20 to 30 seconds. Stir in remaining 2 cans of water.

Dissolve flavored gelatin: Pour boiling water into the blender jar. Remove center ingredient cap and blend at STIR until gelatin is dissolved, about 30 to 60 seconds. Add other ingredients.

Make cookie and graham cracker crumbs: Break larger cookies into pieces about 1½ inches in diameter. Use smaller cookies as is. Place in blender jar. Cover and blend at STIR, pulsing a few times, about 3 seconds each time, until desired consistency is reached. Use the crumbs to make a quick topping for frozen yogurt, pudding, or a fruit compote.

To make a finer crumb for pie and dessert crusts, break graham crackers or cookies into pieces about 1½ inches in diameter. Place in the blender jar. Cover and blend at LIQUEFY, pulsing a few times until desired consistency is reached, about 20 to 30 seconds.

Make cracker crumbs: Follow procedure for cookies. Use to top or as an ingredient in main dish casseroles and vegetable dishes.

Make bread crumbs: Tear bread into pieces about 1½ inches in diameter. Follow procedure for crackers. Use in same ways you would use cracker crumbs.

Blender Tips

How To ...

Chop fruits and vegetables: Put 2 cups of fruit or vegetable chunks in blender jar. Cover and blend at STIR, pulsing a few times, about 2 to 3 seconds each time, until desired consistency is reached.

Puree fruits: Place 2 cups canned or cooked fruit in blender jar. Add 2 to 4 tablespoons fruit juice or water per cup of fruit. Cover and blend at PUREE about 5 to 10 seconds.

Puree vegetables: Place 2 cups canned or cooked vegetables in blender jar. Add 2 to 4 tablespoons broth, water, or milk per cup of vegetables. Cover and blend at PUREE about 10 to 20 seconds.

Puree meats: Place cooked, cubed, tender meat in blender jar. Add 2 to 4 tablespoons broth, water, or milk per cup of meat. Cover and blend on STIR 10 seconds. Stop and scrape sides of blender jar. Cover and blend on PUREE 10 to 20 seconds longer.

Puree cottage cheese or ricotta cheese: Place cottage cheese or ricotta cheese in blender jar. Cover and blend at MIX until smooth, about 25 to 35 seconds. If necessary, add 1 tablespoon skim milk per cup of cottage cheese. Use as a base for lowfat dips and spreads.

Combine liquid ingredients for baked goods: Pour liquid ingredients in blender jar. Cover and blend at LIQUEFY until well mixed, about 1 minute. Pour liquid mixture over dry ingredients and stir well.

Take lumps out of gravy: If sauce or gravy becomes lumpy, place in blender jar. Cover and blend at MIX until smooth, about 5 to 10 seconds.

Combine flour and liquid for thickening: Place flour and liquid in blender jar. Cover and blend at STIR until smooth, about 5 to 10 seconds.

Prepare white sauce: Place milk, flour, and salt, if desired, in blender jar. Cover and blend at STIR until well mixed, about 5 to 10 seconds. Pour into saucepan and cook as usual.

Prepare pancake or waffle batter from mix: Place mix and other ingredients in blender jar. Cover and blend at MIX until well mixed, 10 to 20 seconds; scrape sides of blender jar, if necessary.

Grate cheese: Cut very cold cheese into ½- to 1-inch cubes. Place up to ½ cup cheese in the blender jar. Cover and blend at LIQUEFY about 5 to 10 seconds. For hard cheeses, such as Parmesan, bring to room temperature, then blend at LIQUEFY for 10 to 15 seconds.

Make oatmeal for a baby: Place uncooked rolled oats in blender jar. Blend at MIX until desired consistency, using pulse button, about 5 to 10 seconds. Cook as usual.

Make baby food from adult food: Place prepared adult food in blender jar. Cover and blend at STIR about 10 seconds. Then blend at PUREE about 10 to 30 seconds.

Rinse your blender jar: Fill blender jar one-third to one-half full with warm water. Add a few drops of liquid dish detergent. Cover and blend at STIR until sides are clean, about 5 to 10 seconds. Rinse and dry. For complete cleaning, wash all gaskets separately.

Cranberry Frosty

2 cups cranberry juice cocktail	Place ingredients in blender jar. Cover and blend at CHOP, pulsing 3 to 4 times, about 10 seconds each time, until slushy. Yield: 5 ($\frac{3}{4}$ cup) servings. Per serving: About 159 cal, 0 g pro, 20 g car, 0 g fat, 0 mg chol, 4 mg sod.
1 cup orange juice	
$\frac{3}{4}$ cup vodka	
2 tablespoons lime juice	
2 cups small ice cubes	

Margarita

$\frac{3}{4}$ cup tequila	Place all ingredients in blender jar. Cover and blend at CHOP, pulsing 5 to 6 times, about 10 seconds each time, until slushy. Yield: 6 ($\frac{3}{4}$ cup) servings. Per serving: About 118 cal, 0 g pro, 16 g car, 0 g fat, 0 mg chol, 6 mg sod.
$\frac{1}{2}$ cup triple sec liqueur	
$\frac{1}{2}$ cup lime juice	
$\frac{1}{4}$ cup simple syrup or 1½ tablespoons sugar	
4 cups small ice cubes	

Simple Syrup

1 cup sugar	Combine sugar and water. Boil until sugar dissolves, about 2 to 4 minutes. Cool, cover and refrigerate. Yield: About 1½ cups.
1 cup water	

Frozen Daiquiri

$\frac{3}{4}$ cup rum	Place ingredients in blender jar. Cover and blend at CHOP, pulsing 4 to 5 times, about 10 seconds each time, until slushy. Scrape sides of blender jar, if necessary. Yield: 4 ($\frac{3}{4}$ cup) servings. Variations: Add 2 bananas, 2 cups fresh or frozen strawberries, or 4 medium peaches to above ingredients. Per serving: About 124 cal, 0 g pro, 8 g car, 0 g fat, 0 mg chol, 0 mg sod.
$\frac{1}{4}$ cup lime juice	
$\frac{1}{4}$ cup simple syrup or 2 tablespoons sugar	
3 cups small ice cubes	

Fruit Sparkler

- 1 bottle (750 ml)
champagne or 3
cups club soda
- 1½ cups frozen
strawberries
- 3 tablespoons simple
syrup or 1½
tablespoons sugar

Place 1½ cups champagne and strawberries in blender jar. Cover and blend at CHOP until smooth, about 20 to 30 seconds. Add remaining champagne. Blend at STIR 10 to 15 seconds, until mixed.

Yield: 6 (¾ cup) servings.

Variation: Substitute 1½ cups frozen peach slices, slightly thawed, for strawberries.

Per serving: About 107 cal, 0 g pro, 9 g car, 0 g fat, 0 mg chol, 1 mg sod.

Year-Round Nog

- 4 cups lowfat milk
- 1 container (4 oz.)
refrigerated egg
substitute or 2
pasteurized eggs,
beaten
- 2 tablespoons rum or
brandy, if desired
- 1 package (3.4 oz.)
vanilla instant
pudding mix
- ¼ teaspoon nutmeg
Whipped cream, if
desired
Nutmeg, if desired

Place 2 cups milk, egg substitute, rum, pudding mix, and ¼ teaspoon nutmeg in blender jar. Cover and blend at STIR until blended, about 5 seconds. Add remaining milk. Cover and blend at MIX until smooth, about 5 to 10 seconds. Garnish each serving with whipped cream and a sprinkle of nutmeg, if desired. Refrigerate any leftovers.

Note: Mixture will thicken slightly as it stands. Stir in 1 to 2 tablespoons milk to thin to desired consistency.

Yield: 10 (½ cup) servings.

Per serving: About 107 cal, 5 g pro, 15 g car, 3 g fat, 8 mg chol, 217 mg sod.

Seafood Spread

- 1 *teaspoon margarine or butter*
- 1 *teaspoon olive oil*
- 4 *ounces shelled and deveined, small raw shrimp*
- ½ *cup sliced fresh mushrooms*
- 1 *clove garlic, minced*
- ⅔ *cup (3 oz.) imitation crab meat (surimi) or crab meat*
- 3 *tablespoons sliced green onions*
- 1 *teaspoon Worcestershire sauce*
- 3 *to 5 drops hot pepper sauce*
- 4 *ounces light cream cheese*
- 2 *tablespoons nonfat plain yogurt*
- ¼ *teaspoon salt, if desired*

Heat margarine and olive oil in small non-stick skillet over medium-high heat. Add shrimp, mushrooms, and garlic. Cook and stir about 2 minutes. Add crab and green onions. Cook and stir until shrimp are opaque and mushrooms are tender, about 2 minutes. Add Worcestershire sauce and hot pepper sauce. Remove from heat and set aside.

Place remaining ingredients in blender jar. Cover and blend at STIR until smooth, about 15 seconds; scrape sides of blender jar, if necessary. Add seafood mixture. Blend at STIR until mixed, about 10 to 15 seconds; scrape sides of blender jar, if necessary.

Chill. Serve as a spread for crackers.

Yield: 1½ cups; 24 (1 tablespoon) servings.

Per serving: About 21 cal, 3 g pro, 0 g car, 1 g fat, 13 mg chol, 56 mg sod.

Southwestern Dip

- 4 *ounces light cream cheese*
- 1 *can (15 oz.) black beans, rinsed and well drained, ¼ cup liquid reserved*
- 1 *or 2 fresh jalapeño peppers, stems and seeds removed*
- ½ *teaspoon cumin*
- ¼ *teaspoon salt*
- 2 *medium green onions, cut in ½-inch pieces*
- ½ *cup canned or cooked frozen kernel corn, drained*
- 1 *chunk (1-inch) red bell pepper, if desired*
- 1 *tablespoon fresh cilantro leaves, if desired*

Place cream cheese, ¼ cup reserved liquid from beans, jalapeño peppers, cumin, and salt in blender jar. Cover and blend at CHOP until smooth, about 10 to 20 seconds; scrape sides of blender jar, if necessary.

Add green onions, corn, red pepper, cilantro, and beans to blender jar. Cover and blend at CHOP until green onions and pepper are chopped, about 10 to 15 seconds.

Chill. Serve with vegetable dippers, pita bread, or tortilla chips.

Yield: 2 cups; 32 (1 tablespoon) servings.

Per serving: About 19 cal, 1 g pro, 3 g car, 0 g fat, 1 mg chol, 81 mg sod.

Hummus Dip

- ½ small fresh jalapeño pepper, stem and seeds removed*
- 1 clove garlic*
- ½ medium onion, cut into 1-inch chunks*
- ¼ medium green pepper, cut into 1-inch chunks*
- 2 teaspoons olive oil*
- ½ teaspoon cumin*
- 1 can (15 oz.) garbanzo beans, drained ½ cup liquid reserved*
- ¼ teaspoon sesame oil, if desired*
- 1 small tomato, seeded and chopped, if desired*

Place jalapeño pepper and garlic in blender jar. Cover and blend at STIR until chopped, about 5 to 10 seconds. Add onion and green pepper. Cover and blend at MIX; pulse 2 or 3 times, about 5 seconds each time, until onion and green pepper are chopped.

Heat oil in small non-stick skillet over medium-high heat. Add onion mixture and cumin. Cook and stir until vegetables are crisp-tender.

Place onion mixture, beans, reserved liquid, and sesame oil in blender jar. Cover and blend at MIX until smooth, about 20 to 30 seconds to 1 minute; scrape sides of blender jar, if necessary.

Place in serving bowl. Stir in tomato, if desired. Serve with vegetable dippers, pita wedges, or cracker bread.

Yield: 2 cups; 32 (1 tablespoon) servings.

Per serving: About 21 cal, 1 g pro, 4 g car, 0 g fat, 0 mg chol, 40 mg sod.

Fruit Dip

- 1 can (15 oz.) sliced peaches, packed in fruit juice and well drained*
- 2 tablespoons light pasteurized process cream cheese product (from an 8-oz. tub)*
- 2 tablespoons frozen orange juice concentrate*
- 2 teaspoons powdered sugar*
- ¼ teaspoon vanilla*
Dash nutmeg

Place all ingredients in blender jar. Cover and blend at STIR until smooth, about 15 to 20 seconds. Serve with assorted fruits or angel food cake cubes.

Yield: 24 (1 tablespoon) servings.

Tip: To make juice with remaining concentrate, measure amount of concentrate. Add three times the amount of water as concentrate.

Per serving: About 10 cal, 0 g pro, 2 g car, 0 g fat, 0 mg chol, 7 mg sod.

Spinach Pita Wedges

- 2 *tablespoons chopped onion* Place onion, garlic, and olive oil in small non-stick skillet. Cool and stir over medium heat until onion is crisp-tender.
- 1 *clove garlic, minced*
- 2 *teaspoons olive oil* Place ricotta, egg substitute, and salt in blender jar. Cover and blend at CHOP until mixed, about 10 seconds. Scrape down sides, if necessary. Add onion mixture, spinach, bell pepper, water chestnuts, and red pepper flakes. Blend at MIX until mixed, 30 to 45 seconds; scrape sides of blender jar, if necessary.
- 1 *cup light ricotta cheese*
- $\frac{1}{4}$ *cup egg substitute or 1 egg*
- $\frac{1}{4}$ *teaspoon salt*
- 1 *package (9 or 10 oz.) frozen chopped spinach, thawed and pressed dry* Spoon about $\frac{1}{4}$ cup mixture on each pita loaf. Place loaves on large baking sheet. Bake at 350°F for 9 to 11 minutes, until set. Cut each loaf into 6 wedges.
- 2 *chunks (1-inch each) red bell pepper*
- 2 *tablespoons drained, sliced water chestnuts* Yield: 48 appetizers (3 appetizers per serving).
- $\frac{1}{4}$ *teaspoon crushed red pepper flakes* Per serving: About 73 cal, 4 g pro, 10 g car, 2 g fat, 4 mg chol, 150 mg sod.
- 4 *pita loaves (6 or 7 inches in diameter), halved to make 8 rounds lightly toasted*

Caponata

- 1 *medium (about 1 lb.) eggplant* Pierce whole eggplant several times with fork. Place in baking pan; bake at 400°F for 40 to 50 minutes, or until very tender. Cool 5 to 10 minutes. Peel and cube.
- 1 *cup sliced fresh mushrooms*
- $\frac{1}{2}$ *cup chopped onion* Place mushrooms, onion, garlic, and oil in medium non-stick skillet. Cook and stir over medium heat until mushrooms are tender. Add tomato, lemon juice, oregano, and salt. Cook 10 minutes, stirring frequently. Cool 5 minutes.
- 2 *cloves garlic, minced*
- 1 *tablespoon olive oil*
- 1 *medium tomato, seeded and chopped*
- 2 *tablespoons lemon juice* Place eggplant, mushroom mixture, and chicken broth in blender jar. Cover and blend at PUREE until smooth, about 30 to 45 seconds, scrape sides of blender jar, if necessary.
- 1 *teaspoon dried oregano*
- $\frac{3}{4}$ *teaspoon salt*
- 2 *tablespoons reduced-sodium chicken broth or water* Serve with vegetable dippers, crackers, or pita wedges.
- Yield: 3 cups; 24 (2 tablespoons) servings.
- Per serving: About 14 cal, 0 g pro, 2 g car, 1 g fat, 0 mg chol, 76 mg sod.

Blueberry Soup

- 4 cups fresh or frozen blueberries, thawed
- ¼ cup lemon juice
- ½ cup sugar
- 2 tablespoons cornstarch
- ⅛ teaspoon nutmeg
- 1 cup cranberry juice cocktail
- ¾ cup dry white wine or unsweetened apple juice
- ½ teaspoon vanilla
- ¼ cup nonfat vanilla yogurt

Place 3 cups blueberries and lemon juice in saucepan. Bring to boil. Lower heat and simmer until berries begin to pop, about 2 minutes. Cool 5 minutes.

Pour blueberry mixture into blender jar. Blend at CHOP until mixture is finely chopped, about 20 to 25 seconds.

Combine sugar, cornstarch, and nutmeg in saucepan. Stir in cranberry juice cocktail and wine. Pour blueberry mixture through strainer into saucepan, rubbing with back of spoon. Discard seeds and skin. Bring to boil. Reduce heat to simmer and cook until mixture thickens and becomes clear, about 2 minutes. Stir in vanilla.

Refrigerate until cooled, about 1 hour. Stir in remaining blueberries. Refrigerate until well chilled, about 4 to 5 hours. Top each serving with yogurt.

Yield: 4 (1 cup) servings.

Per serving: About 270 cal, 2 g pro, 61 g car, 1 g fat, 0 mg chol, 21 mg sod.

Avocado Lime Soup

- 1 can (14½ oz.) reduced-sodium chicken broth, chilled
- ½ cup nonfat plain yogurt
- ¼ cup lime juice
- 1 medium ripe avocado, peeled, seeded and quartered
- 1 teaspoon dried dill weed
- ¼ teaspoon black pepper

Place ingredients in blender jar. Cover and blend at MIX until smooth, about 45 seconds to 1 minute. Refrigerate until well chilled, about 2 to 3 hours.

Yield: 4 (1 cup) servings.

Per serving: About 110 cal, 4 g pro, 7 g car, 8 g fat, 1 mg chol, 47 mg sod.

Borscht

<i>1½ cups peeled, and cubed beets</i>	Place beets, potato, onion, and 1¼ cups broth in blender jar. Cover and blend at MIX until finely chopped, about 35 to 45 seconds. Pour into saucepan.
<i>1 medium potato, peeled and cubed</i>	
<i>1 small onion, quartered</i>	Add remaining broth, lemon juice, sugar, salt, and pepper. Bring to a boil; reduce heat to simmer and cook about 10 minutes.
<i>2½ cups reduced-sodium chicken broth</i>	
<i>¼ cup lemon juice</i>	Refrigerate until well chilled, about 6 to 8 hours. Top each serving with sour cream.
<i>4 teaspoons sugar</i>	
<i>¼ teaspoon salt</i>	Yield: 5 (1 cup) servings. Per serving: About 82 cal, 4 g pro, 17 g car, 0 g fat, 0 mg chol, 387 mg sod.
<i>¼ teaspoon pepper</i>	
<i>¼ cup nonfat sour cream</i>	

Scandinavian Fruit Soup

<i>2 cups water</i>	Combine water, prunes, apple, apricots, sugar, and cinnamon stick in saucepan. Bring to a boil over high heat; reduce heat to simmer and cook, covered, until fruit is tender, about 30 to 40 minutes. Remove from heat; uncover and cool at room temperature 10 minutes. Remove cinnamon stick. Pour ½ cup apple juice into blender jar. Add fruit mixture. Blend at STIR 5 to 10 seconds to chop fruit, then blend at PUREE until mixture is smooth, about 15 to 20 seconds.
<i>1 cup pitted prunes</i>	
<i>1 medium apple, peeled, cored and quartered</i>	Pour into bowl and stir in remaining apple juice. Refrigerate until well chilled, about 5 to 6 hours. Top each serving with about a teaspoon of port wine, if desired.
<i>½ cup dried apricots</i>	
<i>½ cup sugar</i>	Yield: 6 (1 cup) servings. Per serving: About 192 cal, 1 g pro, 49 g car, 0 g fat, 0 mg chol, 12 mg sod.
<i>1 cinnamon stick</i>	
<i>2½ cups apple juice</i>	
<i>Port wine, if desired</i>	

Gazpacho

- 2 cans (14½ oz. each)
no-salt-added peeled
tomatoes
- 2 ribs celery, cut into
2-inch chunks
- 1 medium cucumber,
peeled and cut into
chunks
- 1 medium onion, cut
into chunks
- 1 small green pepper,
cut into chunks
- 2 teaspoons snipped
fresh parsley
- 1 teaspoon snipped
fresh chives
- 1 clove garlic
- 3 tablespoons olive oil
- 3 tablespoons red wine
vinegar
- 2 cups vegetable juice
cocktail
- ¼ teaspoon black
pepper
Hot pepper sauce

Place one can tomatoes, celery, and cucumber in blender jar. Cover and blend at CHOP until finely chopped, about 10 to 15 seconds. Pour into large bowl.

Place second can tomatoes, onion, green pepper, parsley, chives, garlic, olive oil, and red wine vinegar in blender jar. Cover and blend at CHOP until finely chopped, about 10 to 15 seconds.

Pour into bowl. Stir in vegetable juice cocktail, black pepper, and a few drops of hot pepper sauce. Refrigerate until well chilled, about 6 to 8 hours.

Yield: 6 (1 cup) servings.

Per serving: About 119 cal, 4 g pro, 13 g car,
7 g fat, 0 mg chol, 337 mg sod.

Vichyssoise

- 1 tablespoon
margarine
- 1 medium onion,
sliced, or 1½ cups
sliced leeks
- 2 medium potatoes,
peeled and cubed
- 3 cups reduced-sodium
chicken broth
- ¼ teaspoon black
pepper
- 1 cup lowfat (2%) milk
Snipped chives, if
desired

Melt margarine in skillet over medium heat. Add onion. Cook and stir until onion is soft, about 3 minutes. Place in blender jar with potatoes and 1½ cups broth. Cover and blend at STIR until coarsely chopped, about 5 to 10 seconds. Blend at LIQUEFY until finely chopped, about 20 to 30 seconds. Pour into saucepan.

Stir in remaining broth and pepper. Bring to a boil; reduce heat and simmer until vegetables are crisp-tender, about 12 to 15 minutes, stirring frequently. Remove from heat. Stir in milk.

Refrigerate until well chilled, about 6 to 8 hours. Top each serving with snipped chives, if desired.

Yield: 6 (1 cup) servings.

Per serving: About 94 cal, 4 g pro, 12 g car,
3 g fat, 3 mg chol, 79 mg sod.

Southern Cornmeal Waffles

- 2 eggs
- 1¾ cups lowfat buttermilk
- ½ cup margarine or butter, melted
- 1¼ cups all-purpose flour
- ¾ cup yellow cornmeal
- 1 tablespoon sugar
- 2 teaspoons baking powder
- 1 teaspoon baking soda
- ¼ teaspoon salt
- ¼ teaspoon allspice

Heat waffle iron. Place eggs in blender jar. Cover and blend at STIR about 5 seconds. Add buttermilk and margarine. Blend at MIX about 10 seconds. Add remaining ingredients. Blend at MIX about 60 seconds; scrape sides of blender jar every 20 seconds.

Bake in hot waffle iron until waffles are golden brown, about 3 to 5 minutes.

Yield: About 4 servings (2, 4-inch waffles each).

Per serving: About 471 cal, 13 g pro, 60 g car, 20 g fat, 113 mg chol, 1028 mg sod.

Pumpkin Walnut Waffles

Topping

- 1 cup vanilla lowfat yogurt
- ¼ cup maple syrup

Combine topping ingredients in small bowl. Set aside.

Waffles

- 2 eggs
- 1¾ cups skim or lowfat milk
- ¾ cup canned pumpkin
- 2 tablespoons vegetable oil
- 2 cups all-purpose flour
- 2 tablespoons sugar
- 2 teaspoons baking powder
- ½ teaspoon cinnamon
- ¼ teaspoon salt
- ¼ teaspoon nutmeg
- ¼ teaspoon cloves
- ¼ cup chopped walnuts
- Chopped walnuts for garnish, if desired

Heat waffle iron. Place eggs in blender jar. Cover and blend at STIR about 5 seconds. Add milk, pumpkin, and oil. Blend at MIX about 10 seconds. Add remaining ingredients except nuts. Blend at MIX about 60 seconds; scrape sides of blender jar every 20 seconds. Add ¼ cup chopped walnuts. Blend at STIR about 5 seconds.

Bake in hot waffle iron until waffles are golden brown, about 3 to 5 minutes. Serve with yogurt topping and sprinkle with walnuts, if desired.

Yield: About 5 servings (2, 4-inch waffles each).

Per serving: About 452 cal, 15 g pro, 72 g car, 12 g fat, 90 mg chol, 415 mg sod.

Orange Yogurt Waffles

- 2 eggs
- 1 cup orange lowfat yogurt
- ½ cup skim or lowfat milk
- 2 tablespoons vegetable oil
- 2 tablespoons honey
- 1½ cups all-purpose flour
- ¾ cup oat bran
- 2 teaspoons baking powder
- 1 teaspoon baking soda
- ½ teaspoon grated orange peel
- ¼ teaspoon allspice
- Maple syrup, if desired
- Orange lowfat yogurt, if desired

Heat waffle iron. Place eggs in blender jar. Cover and blend at STIR about 5 seconds. Add yogurt, milk, oil, and honey. Blend at MIX about 10 seconds. Add flour, oat bran, baking powder, baking soda, orange peel, and allspice. Blend at MIX about 60 seconds; scrape sides of blender jar every 20 seconds.

Bake in hot waffle iron until waffles are golden brown, about 3 to 5 minutes. Serve with maple syrup and a dollop of orange yogurt, if desired.

Yield: About 4 servings (2, 4-inch waffles each).

Per serving: About 167 cal, 6 g pro, 28 g car, 5 g fat, 44 mg chol, 206 mg sod.

Oatmeal Pancakes with Raisin Topping

Topping

- 1 cup maple syrup
- ½ cup raisins (mix golden and regular, if desired)

Place maple syrup and raisins in small saucepan. Bring to a boil. Remove from heat. Set aside.

Place eggs in blender jar. Cover and blend at STIR about 5 seconds. Add milk and oil. Blend at MIX about 10 seconds.

Pancakes

- 2 eggs
- 2 cups skim or lowfat milk
- 2 tablespoons vegetable oil
- 1¼ cups all-purpose flour
- ½ cup whole wheat flour
- 2 tablespoons sugar
- 2 teaspoons baking powder
- ½ teaspoon cinnamon
- ¼ teaspoon salt
- 1 cup quick-cooking rolled oats

Add all remaining ingredients except oats. Blend at MIX about 60 seconds; scrape sides of blender jar every 20 seconds. Add oats and blend at STIR about 10 seconds.

Spray griddle with no-stick cooking spray and heat to medium-high. Pour ¼ cup batter for each pancake onto griddle. Cook until bubbles form on surface and edges become dry, about 1 to 2 minutes. Turn; cook until golden brown on underside, about 1 to 2 minutes. Serve with raisin topping.

Yield: About 8 servings (2, 4-inch pancakes each).

Per serving: About 354 cal, 9 g pro, 69 g car, 6 g fat, 54 mg chol, 248 mg sod.

Blueberry Pancakes

Sauce

- ¼ cup sugar*
- 2 teaspoons cornstarch*
- ¾ cup water*
- ½ teaspoon grated lemon peel*
- 2 cups fresh or frozen blueberries (do not thaw)*

Place sauce ingredients in saucepan. Cook over medium heat until mixture thickens, stirring constantly. Cool 5 minutes. Pour mixture into blender jar. Cover and blend at STIR about 5 seconds; scrape sides of blender jar. Blend at MIX about 15 seconds. Pour into serving container.

Place eggs in blender jar. Cover and blend at STIR about 5 seconds. Add buttermilk and lemon peel. Blend at MIX about 10 seconds. Add flour, sugar, baking soda, and nutmeg. Blend at MIX until smooth, about 60 seconds; scrape sides of blender jar every 20 seconds. Gently stir in blueberries.

Pancakes

- 2 eggs*
- 2 cups lowfat buttermilk*
- ½ teaspoon grated lemon peel*
- 2¼ cups all-purpose flour*
- 1 tablespoon sugar*
- 1 teaspoon baking soda*
- ¼ teaspoon nutmeg*
- 1 cup fresh or frozen blueberries (do not thaw)*

Spray griddle with no-stick cooking spray and heat to medium-high. Pour scant ¼ cup batter for each pancake onto griddle. Cook until bubbles form on surface and edges become dry, about 1 to 2 minutes. Turn; cook until golden brown on underside, about 1 to 2 minutes. Serve with warm blueberry sauce.

Yield: About 8 servings (2, 4-inch pancakes each).

Per serving: About 119 cal, 4 g pro, 23 g car, 1 g fat, 28 mg chol, 107 mg sod.

Fruit-Topped Oven Pancakes

Fruit Topping

- 1 *tablespoon margarine or butter*
- $\frac{1}{4}$ *cup packed brown sugar*
- $\frac{1}{4}$ *teaspoon cinnamon*
- $\frac{1}{8}$ *teaspoon cloves*
- $1\frac{1}{2}$ *teaspoons cornstarch*
- 1 *cup orange juice*
- $1\frac{1}{2}$ *cups (1 medium) sliced, unpeeled apple*
- $1\frac{1}{2}$ *cups (1 medium) sliced, unpeeled pear*
- $\frac{1}{2}$ *cup dried apricots*
- $\frac{1}{4}$ *cup raisins*

Heat margarine in large skillet over medium heat. Add brown sugar, cinnamon, and cloves. In small bowl, blend cornstarch and orange juice until smooth. Pour mixture into skillet. Bring to a boil, stirring constantly. Stir in apple, pear, apricots, and raisins. Reduce heat to low and simmer, uncovered, until fruit is tender, about 5 minutes. Set aside.

Place eggs in blender jar. Cover and blend at STIR about 5 seconds. Add milk and blend at STIR about 5 seconds. Add remaining pancake ingredients except margarine. Blend at MIX about 10 seconds; scrape sides of blender jar. Blend at MIX about 10 seconds.

Place margarine in 13x9-inch pan. Heat in oven to melt, about 2 to 3 minutes. Remove pan and tilt to coat with melted margarine. Immediately pour batter into hot pan. Bake at 425°F for 15 minutes. Reduce oven temperature to 375°F. Continue baking 14 to 18 minutes, or until puffed and golden brown. Cut into 8 pieces and serve with warm fruit topping.

Yield: 8 servings.

Per serving: About 245 cal, 6 g pro, 45 g car, 5 g fat, 81 mg chol, 144 mg sod.

Oven Pancakes

- 3 *eggs*
- 1 *cup skim or lowfat milk*
- $1\frac{1}{4}$ *cups all-purpose flour*
- 2 *teaspoons sugar*
- $\frac{1}{2}$ *teaspoon grated orange peel*
- $\frac{1}{4}$ *teaspoon cinnamon*
- $\frac{1}{4}$ *teaspoon salt*
- 1 *tablespoon margarine or butter*

Apple-Pineapple Sauce

- 2 cups chopped, and peeled apples
- $\frac{1}{4}$ cup water
- 1 can (8 oz.) pineapple tidbits in juice, drained

Place apples and water in saucepan. Bring to a boil. Reduce heat to medium. Cook uncovered, until apples are tender, about 8 to 10 minutes; stir occasionally. Cool 5 minutes.

Place pineapple tidbits and apple mixture in blender jar. Cover and blend at STIR about 10 seconds; scrape sides of blender jar, if necessary. Blend at PUREE about 30 seconds. Store in refrigerator.

Yield: 6 ($\frac{1}{4}$ cup) servings.

Per serving: About 36 cal, 0 g pro, 9 g car, 0 g fat, 0 mg chol, 1 mg sod.

Peach Oatmeal

- $\frac{3}{8}$ cup water
- $\frac{1}{8}$ cup quick-cooking rolled oats
- $\frac{1}{4}$ cup canned or frozen and thawed peach slices in juice, drained
- 1 tablespoon whole milk

Place water in saucepan. Bring to a boil. Stir in oats and return to a boil. Reduce heat to low and simmer, uncovered, about 1 minute. Cover and cool 5 minutes.

Place oatmeal, peaches, and milk in blender jar. Cover and blend at STIR about 10 seconds; scrape sides of blender jar, if necessary. Blend at PUREE about 20 to 30 seconds. Store in refrigerator.

Yield: 3 ($\frac{1}{4}$ cup) servings.

Per serving: About 45 cal, 2 g pro, 8 g car, 1 g fat, 1 mg chol, 6 mg sod.

Chicken and Rice Stew

<i>4 to 6 ounces boneless and skinless chicken breast, cut into 1-inch pieces</i>	Place chicken, carrots, rice, and 1 cup broth in saucepan. Bring to a boil. Reduce heat to low and simmer, covered, until most of the liquid is absorbed, about 10 to 15 minutes. Cover and cool 5 minutes.
<i>½ cup sliced carrots</i>	
<i>¼ cup uncooked long-grain white rice</i>	Place chicken mixture and remaining chicken broth in blender jar. Cover and blend at STIR about 10 seconds; scrape sides of blender jar, if necessary. Blend at PUREE about 30 to 40 seconds; scrape sides of blender jar every 10 seconds. Store in refrigerator.
<i>1¼ cups reduced-sodium chicken broth</i>	
	Yield: 6 (¼ cup) servings.
	Per serving: About 59 cal, 5 g pro, 7 g car, 1 g fat, 11 mg chol, 26 mg sod.

Carrot and Potato Medley

<i>½ cup (1 small) sliced carrot</i>	Place carrot, potato, and broth in saucepan. Bring to a boil. Reduce heat to low and simmer, uncovered, until vegetables are very tender, about 10 to 15 minutes. Cool 5 minutes.
<i>½ cup (1 medium) peeled, and cubed potato</i>	
<i>½ cup reduced-sodium chicken broth</i>	Place cooled vegetable mixture and 2 tablespoons milk in blender jar. Cover and blend at STIR about 10 seconds; scrape sides of blender jar, if necessary. Blend at PUREE about 30 seconds; scrape sides of blender jar every 10 seconds. Add 1 more tablespoon milk, if necessary, blend at PUREE about 10 seconds. Store in refrigerator.
<i>2 to 3 tablespoons whole milk</i>	
	Yield: 4 (¼ cup) servings.
	Per serving: About 29 cal, 1 g pro, 5 g car, 0 g fat, 1 mg chol, 18 mg sod.

Banana Fruit Dressing

<i>½ cup vanilla or strawberry lowfat yogurt</i>	Place ingredients in blender jar. Cover and blend at PUREE about 30 seconds; scrape sides of blender jar every 20 seconds. Serve over sliced fresh fruit.
<i>1 medium banana, sliced</i>	Yield: 1 cup; 16 (1 tablespoon) servings.
<i>1 tablespoon honey</i>	Per serving: About 14 cal, 0 g pro, 3 g car, 0 g fat, 0 mg chol, 4 mg sod.
<i>1 tablespoon orange juice</i>	
<i>⅛ teaspoon cinnamon</i>	

Raspberry Vinaigrette Dressing

<i>1 cup fresh or frozen raspberries, thawed</i>	Place ingredients in blender jar. Cover and blend at STIR about 15 seconds; scrape sides of blender jar every 10 seconds. Blend at LIQUEFY about 15 to 20 seconds. Serve over tossed green salads or fruit salads.
<i>2 tablespoons sugar</i>	Yield: 1 cup; 16 (1 tablespoon) servings.
<i>3 tablespoons raspberry vinegar</i>	Per serving: About 17 cal, 0 g pro, 2 g car, 1 g fat, 0 mg chol, 0 mg sod.
<i>2 tablespoons oil</i>	

Dijon Cottage Cheese Dressing

<i>½ cup nonfat or lowfat cottage cheese</i>	Place ingredients in blender jar. Cover and blend at MIX about 30 seconds; scrape sides of blender jar every 20 seconds. Blend at LIQUEFY about 20 seconds. Serve over tossed green salads.
<i>½ cup skim or lowfat milk</i>	Yield: 16 (1 tablespoon) servings.
<i>¼ cup light mayonnaise</i>	Per serving: About 17 cal, 1 g pro, 1 g car, 1 g fat, 2 mg chol, 41 mg sod.
<i>2 teaspoons Dijon mustard</i>	
<i>¼ teaspoon sugar</i>	
<i>¼ teaspoon dried dill weed</i>	
<i>Dash salt and pepper</i>	

Fresh Tomato Marinara Sauce

2 <i>tablespoons olive oil</i>	Heat olive oil in large saucepan over medium-high heat. Add onion, green pepper, and garlic. Cook, uncovered, 2 to 3 minutes. Add remaining ingredients. Reduce heat to low and simmer, covered, until tomatoes are very tender, about 15 to 20 minutes; stir occasionally. Cool 5 minutes.
$\frac{1}{2}$ <i>cup chopped onion</i>	
$\frac{1}{2}$ <i>cup chopped green pepper</i>	
2 <i>cloves garlic, chopped</i>	
3 <i>cups (about 3 large) peeled, and chopped tomatoes</i>	Pour half of cooled tomato mixture into blender jar. Cover and blend at STIR about 15 seconds. Add remaining tomato mixture. Blend at PUREE about 20 to 30 seconds. Return mixture to saucepan. Simmer over low heat about 5 to 10 minutes, stir occasionally. Serve over pasta.
1 <i>can (6 oz.) no-salt-added tomato paste</i>	
2 <i>teaspoons sugar</i>	
1 <i>teaspoon dried basil</i>	
$\frac{1}{2}$ <i>teaspoon dried oregano</i>	Yield: 2 cups; 4 ($\frac{1}{2}$ cup) servings.
$\frac{1}{2}$ <i>teaspoon salt</i>	Per serving: About 148 cal, 3 g pro, 20 g car, 8 g fat, 0 mg chol, 342 mg sod.
$\frac{1}{4}$ <i>teaspoon fennel seed</i>	

Burgundy Mushroom Sauce

2 <i>tablespoons margarine or butter</i>	Heat margarine in large saucepan over medium-high heat. Add onion, carrot, and garlic. Cook, uncovered, 2 to 3 minutes. Stir in flour, broth, and water. Bring to a boil. Reserve $\frac{1}{2}$ cup mushrooms; add remaining mushrooms to saucepan. Reduce heat to low and simmer, uncovered, until vegetables are tender, about 10 to 15 minutes. Cool 5 minutes.
$\frac{1}{2}$ <i>cup chopped onion</i>	
$\frac{1}{4}$ <i>cup chopped carrot</i>	
1 <i>clove garlic, chopped</i>	
1 <i>tablespoon all-purpose flour</i>	Place cooled mushroom mixture in blender jar. Cover and blend at STIR about 30 seconds; scrape sides of blender jar every 10 seconds. Blend at LIQUEFY about 30 seconds. Return mixture to saucepan. Add reserved mushrooms, wine, marjoram, salt, and pepper. Simmer about 5 minutes. Stir in parsley. Serve with beef or pork roasts.
1 <i>cup beef broth</i>	
$\frac{1}{2}$ <i>cup water</i>	Yield: 6 ($\frac{1}{2}$ cup) servings.
1 <i>package (8 oz.) fresh mushrooms, thinly sliced</i>	Per serving: About 13 cal, 0 g pro, 1 g car, 1 g fat, 0 mg chol, 38 mg sod.
$\frac{1}{4}$ <i>cup burgundy wine</i>	
$\frac{1}{4}$ <i>teaspoon dried marjoram</i>	
<i>Dash salt and pepper</i>	
2 <i>tablespoons chopped fresh parsley</i>	

Red Pepper Sauce

<i>1 large red bell pepper, cut in 8 pieces</i>	Place red bell pepper pieces in saucepan and cover with water. Bring to a boil. Reduce heat to low and simmer, uncovered, until pepper is tender, about 10 to 15 minutes. Drain well. Cool 5 minutes.
<i>½ cup nonfat or lowfat plain yogurt</i>	
<i>2 tablespoons light mayonnaise</i>	Place cooled pepper pieces in blender jar. Add remaining ingredients. Cover and blend at MIX about 10 seconds; scrape sides of blender jar, if necessary. Blend at PUREE about 40 seconds; scrape sides of blender jar every 20 seconds. Serve over hot vegetables. Yield: 1 cup; 8 (2 tablespoons) servings. Per serving: About 22 cal, 1 g pro, 2 g car, 1 g fat, 0 mg chol, 106 mg sod.
<i>½ teaspoon sugar</i>	
<i>¼ teaspoon salt</i>	
<i>⅛ teaspoon garlic powder</i>	
<i>⅛ to ¼ teaspoon hot pepper sauce</i>	

Strawberry Romanoff Sauce

<i>3 cups sliced strawberries</i>	Place 1½ cups strawberries in blender jar. Add sugar, orange liqueur, and orange peel. Cover and blend at STIR about 15 seconds; scrape sides of blender jar. Blend at PUREE about 15 seconds. Gently stir in remaining strawberries. Serve over ice cream or cake. Yield: 2 cups; 8 (¼ cup) servings. Per serving: About 62 cal, 0 g pro, 13 g car, 0 g fat, 0 mg chol, 1 mg sod.
<i>¼ cup sugar</i>	
<i>3 tablespoons orange liqueur</i>	
<i>½ teaspoon grated orange peel</i>	

Barbecue Meat Filling

- $\frac{3}{8}$ cup low-sodium catsup
- $\frac{1}{4}$ cup chopped onion
- $\frac{1}{4}$ cup brown sugar
- $\frac{1}{4}$ cup light molasses
- 2 tablespoons cider vinegar
- 2 tablespoons prepared mustard
- 1 teaspoon Worcestershire sauce
- 2 cloves garlic, halved
- Dash liquid smoke flavor, if desired
- 2 cups cubed cooked turkey breast

Place all ingredients except turkey in blender jar. Cover and blend at STIR until onion and garlic are chopped, about 15 to 20 seconds; scrape sides of blender jar.

Add half of turkey. Cover and blend at STIR until meat is chopped, about 10 to 20 seconds. Add remaining turkey. Cover and blend at STIR about 10 to 20 seconds, until meat is chopped.

In medium saucepan, heat meat mixture over medium-high heat until hot; stir occasionally. Reduce heat to simmer and cook, covered, to blend flavors, about 10 minutes; stir occasionally. Serve with pita bread or sourdough buns.

Yield: 2½ cups; 4 (about ½ cup) servings.

Variations: Substitute cooked chicken or 97% fat-free beef or ham for the turkey breast.

Per serving: About 199 cal, 15 g pro, 33 g car, 1 g fat, 40 mg chol, 134 mg sod.

Southwestern Wraps

- 1 or 2 jalapeño pepper, stem and seeds removed
- 1 clove garlic
- 2 tablespoons chopped onion
- 1 can (15.5 oz.) 50% less salt kidney beans, undrained
- 2 tablespoons salsa
- 1 teaspoon cumin
- 1 tablespoon chopped fresh cilantro leaves, if desired
- 1 cup cubed cooked chicken breast
- $\frac{1}{2}$ cup shredded nonfat Cheddar cheese
- 6 flour tortillas (8 inches in diameter)
- Salsa and light sour cream garnish, if desired

Place all ingredients except flour tortillas and garnish in blender jar in order listed. Cover and blend at CHOP, pulsing 5 or 6 times, until thoroughly mixed, scrape sides of blender jar, if necessary.

Spread about ½ cup of bean mixture in center of each tortilla. Roll tortilla to enclose filling. Place on microwave-safe plate. Microwave at HIGH 20 to 30 seconds, or until heated through.

Serve with salsa and light sour cream garnish, if desired.

Yield: 6 servings (about ½ cup filling and 1 tortilla each).

Per serving: About 270 cal, 17 g pro, 39 g car, 5 g fat, 21 mg chol, 468 mg sod.

Chicken Salad Spread

<i>¼ cup light mayonnaise</i>	Place all ingredients in blender jar in order listed.
<i>¼ cup light sour cream</i>	Cover and blend at STIR, pulsing 3 to 4 times,
<i>1 tablespoon chopped onion</i>	about 5 seconds each time, until chicken is
<i>1 tablespoon fresh parsley, if desired</i>	chopped and mixture is thoroughly combined.
<i>⅛ teaspoon salt</i>	Yield: 1¼ cups; 5 (¼ cup) servings.
<i>⅛ teaspoon pepper</i>	Per serving: About 118 cal, 10 g pro, 6 g car,
<i>1 cup cubed cooked chicken breast</i>	6 g fat, 28 mg chol, 175 mg sod.
<i>½ cup seedless red grapes</i>	

Open-Faced Ham and Cheese Melts

<i>1 tablespoon water or reduced-sodium chicken broth</i>	Place water, ham, mustard, green pepper, green onion, and water chestnuts in blender jar in order listed. Cover and blend at CHOP, pulsing 1 to 2
<i>1 cup cubed (½-inch cubes) 97% fat-free, reduced-sodium ham</i>	times, about 3 seconds each time, until ham is well chopped and mixture is thoroughly combined; scrape sides of blender jar, if necessary.
<i>1 tablespoon Dijon mustard</i>	Preheat broiler. Top each bread slide with tomato
<i>2 chunks (1-inch each) green bell pepper</i>	slice. Spread about ⅓ cup ham filling on each sandwich. Top each with about 2 tablespoons
<i>1 green onion, cut in ½-inch pieces</i>	cheese. Arrange sandwiches on cookie sheet. Broil 4 to 6 inches from heat about 2 to 3 minutes or
<i>2 tablespoons sliced water chestnuts, drained</i>	until cheese melts.
<i>6 slices Italian bread, lightly toasted</i>	Yield: 6 servings (about ⅓ cup ham filling each).
<i>6 slices tomato, if desired</i>	Per serving: About 134 cal, 10 g pro, 19 g car,
<i>¾ cup shredded fat-free or reduced-fat Cheddar cheese</i>	1 g fat, 14 mg chol, 566 mg sod.

Basil Pesto

- 2 cloves garlic
- ½ cup fresh grated
Parmesan cheese
- 1¾ cup firmly packed
fresh basil leaves
- ¼ cup fresh parsley
leaves
- 3 tablespoons slivered
almonds or pine nuts
- ¼ cup olive oil
- ¼ to ½ cup reduced-
sodium chicken
broth

Place garlic in blender jar. Cover and blend at STIR until minced, about 5 to 10 seconds.

Add basil, parsley, and almonds. Cover and blend at STIR. With blender running, add olive oil and ¼ cup chicken broth. Blend until thoroughly mixed, about 45 seconds to 1 minute; scrape sides of blender jar. Add remaining broth, if necessary. Blend at CHOP for 30 seconds. Serve on pasta, pizza, chicken, or seafood.

Yield: 1 cup; 8 (2 tablespoons) servings.

Per serving: About 111 cal, 4 g pro, 2 g car, 10 g fat, 5 mg chol, 127 mg sod.

Mixed Pepper Pesto

- 1 clove garlic
- 2 tablespoons olive oil
- 1 medium red bell
pepper, seeded and
cut into 1½-inch
chunks
- 1 medium yellow bell
pepper, seeded and
cut into 1½-inch
chunks
- ¼ cup loosely packed
fresh basil leaves
- ½ cup grated fresh
Parmesan cheese
- ¼ teaspoon salt, if
desired
- ½ teaspoon pepper

Place garlic in blender jar. Blend at STIR until minced, about 5 to 10 seconds. Add all remaining ingredients. Blend at CHOP until thoroughly mixed, about 15 to 25 seconds; scrape sides of blender jar, if necessary. Serve on pasta, pizza, chicken, or seafood.

Yield: 1½ cups; 6 (¼ cup) servings.

Tip: Bake 12-inch pizza crust at 425°F about 5 minutes. Remove from oven and spread with pesto. Add cheese, cooked meat, and other favorite toppings. Return pizza to oven and bake at 425°F about 5 minutes, or until cheese is melted and crust is golden brown.

Per serving: About 58 cal, 1 g pro, 2 g car, 5 g fat, 2 mg chol, 40 mg sod.

Mexican Casserole Topping

- 2 flour tortillas (5 or 6 inches in diameter)
- No-stick cooking spray
- ½ cup shredded nonfat Cheddar cheese
- 1 teaspoon chili powder
- ¼ teaspoon cumin
- 2 tablespoons shredded 50%-less-fat Monterey Jack cheese

Heat large non-stick skillet over medium-high heat. Spray both sides of tortillas with no-stick cooking spray to coat lightly. Place tortillas in skillet. Cook until light golden, turning once, about 5 to 7 minutes. Cool completely. Break each tortilla into 8 pieces.

Place tortilla pieces, ¼ cup Cheddar cheese, chili powder, and cumin in blender jar. Cover and blend at CHOP, pulsing 4 to 6 times, about 5 seconds each time, until tortilla pieces are crushed. Add remaining ¼ cup Cheddar cheese and Monterey Jack cheese. Cover and blend at CHOP until mixed, about 5 to 10 seconds.

Use to top favorite ground beef, pasta, or rice casserole cooked in 13x9-inch baking dish.

Yield: 12 servings (about 1 cup)

Per serving: About 23 cal, 2 g pro, 3 g car, 0 g fat, 1 mg chol, 78 mg sod.

Cinnamon-Oat Crunch

- ½ cup whole wheat flour
- ½ cup packed brown sugar
- ¼ cup rolled oats
- ½ teaspoon cinnamon
- ¼ teaspoon salt
- Dash nutmeg
- ¼ cup light pasteurized process cream cheese product (from an 8-oz. tub)

Place all ingredients in blender jar in order listed. Cover and blend at STIR, pulsing 3 or 4 times, about 5 seconds each time, until thoroughly mixed; stir mixture down between pulses, if necessary.

Spread in thin layer on ungreased baking sheet. Bake at 375°F until browned, about 10 minutes, stirring once. Cool completely.

With spatula, loosen mixture from baking sheet and crumble to desired size. Serve over yogurt, frozen yogurt, fruit, or pudding. Place any unused crunch in tightly covered container and store in refrigerator.

Yield: 2 cups; 16 (2 tablespoons) servings.

Per serving: About 51 cal, 1 g pro, 11 g car, 1 g fat, 1 mg chol, 57 mg sod.

Graham-Nut Crunch

- 1 cup broken chocolate or vanilla graham crackers
- 2 tablespoons slivered almonds
- 1 tablespoon semi-sweet chocolate chips
- 1 tablespoon butterscotch chips
- 2 teaspoons flour
- 2 teaspoons melted margarine or butter

Place all ingredients except margarine in blender jar. Blend at CHOP until coarsely chopped, about 5 to 10 seconds. Add margarine. Cover and blend at CHOP, pulsing 2 to 3 times, about 1 to 2 seconds each time, until thoroughly mixed.

Spread in thin layer on ungreased baking sheet. Bake at 350°F almonds are lightly toasted, about 8 to 10 minutes, stirring once. Cool completely.

Sprinkle over frozen yogurt or pudding, if desired. Place any unused crunch in tightly covered container and store in refrigerator.

Yield: 1 cup; 16 (1 tablespoon) servings.

Per serving: About 77 cal, 1 g pro, 11 g car, 3 g fat, 0 mg chol, 96 mg sod.

Streusel Topping

- ½ cup all-purpose flour
- ½ cup packed brown sugar
- ½ teaspoon cinnamon, if desired
- ¼ teaspoon salt
- 2 tablespoons light pasteurized process cream cheese product (from an 8-oz. tub)
- 2 tablespoons pecan halves

Place all ingredients in blender jar in order listed. Cover. Blend at STIR, pulsing 5 to 6 times, 3 seconds each time, until thoroughly mixed; scrape sides of blender jar, if necessary. Use to top 13x9-inch pan of fruit crisp or to sprinkle over 13x9-inch cake before baking.

Yield: 1½ cups; about 12 servings.

Per serving: About 65 cal, 1 g pro, 13 g car, 1 g fat, 1 mg chol, 61 mg sod.

Sparkling Cranberry Drink

- 1 can (11.5 oz.) frozen cranberry juice cocktail concentrate
 1 can (8 oz.) crushed pineapple, packed in fruit juice and undrained.
 1 cup sweetened sparkling water
- Place cranberry concentrate and pineapple in blender jar. Cover and blend at LIQUEFY until smooth, about 10 to 20 seconds. Add sparkling water. Blend at STIR just until mixed, about 2 to 4 seconds.
- Yield: 4 (1 cup) servings.
- Per serving: About 171 cal, 0 g pro, 44 g car, 0 g fat, 0 mg chol, 10 mg sod.

Strawberry-Orange Quick Breakfast Beverage

- 1½ cups orange juice
 1½ cups frozen unsweetened strawberries
 1½ cups nonfat vanilla yogurt
 2 tablespoons sugar, if desired
- Place orange juice and strawberries in blender jar. Cover and blend at CHOP until strawberries are chopped, about 10 to 20 seconds. Add yogurt and sugar, if desired. Blend at STIR until smooth, about 5 to 10 seconds.
- Yield: 4 (1 cup) servings.
- Per serving: About 142 cal, 6 g pro, 30 g car, 1 g fat, 1 mg chol, 64 mg sod.

Raspberry Breakfast Refresher

- 2½ cups orange juice
 1 cup unsweetened frozen raspberries
 3 medium bananas, each broken into 4 pieces each
- Place all ingredients in blender jar. Cover and blend at CHOP until smooth, about 15 to 20 seconds.
- Yield: 5 (1 cup) servings.
- Per serving: About 129 cal, 2 g pro, 31 g car, 1 g fat, 0 mg chol, 2 mg sod.

Peanut Butter-Banana Breakfast Shake

- 1 pint frozen nonfat vanilla yogurt or light ice cream
 1½ cups skim milk
 4 medium bananas, broken into 4 pieces each
 ¼ cup peanut butter
- Place all ingredients in blender jar. Cover and blend at LIQUEFY until smooth, about 20 to 30 seconds.
- Yield: 4 (about 1 cup) servings.
- Per serving: About 323 cal, 13 g pro, 53 g car, 9 g fat, 3 mg chol, 182 mg sod.

Creamy Apricot Zinger

- 1½ cups lowfat buttermilk
- 1 can (16 oz.) apricot halves, packed in fruit juice and well drained.
- ¼ cup frozen orange-pineapple or orange juice concentrate
- ⅛ teaspoon nutmeg, if desired
- 6 ice cubes

Place all ingredients except ice in blender jar. Cover and blend at STIR until thoroughly mixed, about 10 seconds. Add ice. Cover and blend at CHOP, pulsing 6 to 8 times, about 3 seconds each time, until smooth.

Yield: 4 (1 cup) servings.

Tip: To make juice with remaining concentrate, measure amount of concentrate. Add three times the amount of water as concentrate.

Per serving: About 120 cal, 4 g pro, 25 g car, 1 g fat, 3 mg chol, 101 mg sod.

Spice Peach Energy Drink

- 1 cup lowfat buttermilk
- ½ cup skim milk
- 1 can (16 oz.) sliced peaches, packed in fruit juice, chilled and well drained
- 2 tablespoons wheat germ
- 2 tablespoons honey
- ⅛ teaspoon cinnamon
- ⅛ teaspoon nutmeg
- 6 ice cubes

Place all ingredients except ice in blender jar. Cover and blend at LIQUEFY until smooth, about 1 to 1½ minutes. Add ice cubes. Cover and blend at LIQUEFY until slushy, about 45 seconds to 1 minute.

Yield: 4 (1 cup) servings.

Per serving: About 134 cal, 5 g pro, 28 g car, 1 g fat, 3 mg chol, 86 mg sod.

Strawberry-Banana Smoothie

- 1½ cups lowfat buttermilk
- 1 cup frozen unsweetened strawberries
- 1 cup skim milk
- 3 medium bananas, broken into 4 pieces each
- 3 tablespoons orange marmalade

Place all ingredients in blender jar. Cover and blend at LIQUEFY until smooth, about 15 to 20 seconds.

Yield: 5 (1 cup) servings.

Per serving: About 153 cal, 5 g pro, 33 g car, 1 g fat, 5 mg chol, 111 mg sod.

Rum Mocha

- 2 cups chocolate light ice cream
- ½ cup double-strength coffee, cold
- ½ cup dark rum
- 4 ice cubes

Place all ingredients in blender jar. Cover and blend at LIQUEFY until smooth, about 1 to 1½ minutes; scrape sides of blender jar, if necessary.

Yield: 4 (¾ cup) servings.

Per serving: About 185 cal, 4 g pro, 20 g car, 3 g fat, 5 mg chol, 67 mg sod.

Peach Flip

- 1½ cups frozen peach slices, partially thawed
- 1½ cups nonfat frozen peach yogurt
- ½ cup peach liqueur or peach brandy

Place all ingredients in blender jar. Cover and blend at LIQUEFY, pulsing 4 to 5 times, about 10 seconds each time, until smooth.

Yield: 4 (½ cup) servings.

Per serving: About 265 cal, 3 g pro, 49 g car, 0 g fat, 0 mg chol, 39 mg sod.

Tropical Slush

- 1 pint pineapple sherbet
- 1 cup orange juice
- ¾ cup dark rum
- 8 ice cubes

Place all ingredients in blender jar. Cover and blend at LIQUEFY until slushy, about 1 to 1½ minutes.

Yield: 4 (1 cup) servings.

Per serving: About 256 cal, 2 g pro, 36 g car, 2 g fat, 5 mg chol, 31 mg sod.

Frozen Cloud

- 2 cups light ice cream
- ½ cup vodka
- ¼ cup creme de cacao
- 6 ice cubes

Place all ingredients in blender jar. Cover and blend at LIQUEFY, pulsing 4 to 5 times, about 10 seconds each time, until slushy.

Yield: 4 (about ½ cup) servings.

Per serving: About 213 cal, 4 g pro, 26 g car, 3 g fat, 5 mg chol, 67 mg sod.

Banana-Berry Freeze

- 1 package (10 oz.) frozen unsweetened strawberries, partially thawed, broken into chunks
- 1 medium banana, peeled and sliced
- 1½ cups skim milk
- Place all ingredients in blender jar. Cover and blend at LIQUEFY until smooth, about 25 to 30 seconds; scrape sides of blender jar, if necessary.
- Yield: 4 (about 1 cup) servings.
- Per serving: About 84 cal, 4 g pro, 18 g car, 0 g fat, 2 mg chol, 49 mg sod.

Pink Lassies

- 2 cups vanilla light ice cream
- 2 cups cranberry juice cocktail
- 1 cup orange juice
- Place all ingredients in blender jar. Cover and blend at MIX until smooth, about 25 to 30 seconds.
- Yield: 5 (about 1 cup) servings.
- Per serving: About 176 cal, 4 g pro, 36 g car, 2 g fat, 4 mg chol, 55 mg sod.

Fruit Shake

- 2 cups skim milk
- 1½ cups vanilla light ice cream
- 3 medium peaches, peeled and sliced
- Place all ingredients in blender jar. Cover and blend at LIQUEFY until smooth, about 25 to 30 seconds.
- Yield: 5 (about 1 cup) servings.
- Variations:** Substitute 3 cups fresh sliced strawberries or 3 cups sliced banana for peaches.
- Per serving: About 132 cal, 6 g pro, 23 g car, 2 g fat, 5 mg chol, 89 mg sod.

Frozen Apple-Berry Slush

- 1 can (12 oz.) frozen apple juice concentrate
- 1 cup lowfat milk
- 1 cup frozen unsweetened strawberries, slightly thawed
- 3 cups small ice cubes
- Place all ingredients in blender jar. Cover and blend at LIQUEFY, pulsing 2 to 3 times, about 10 seconds each time, until smooth; scrape sides of blender jar, if necessary. Serve in sherbet/champagne glasses with spoons.
- Note:** For a firmer consistency, freeze 1 to 2 hours. Stir; serve as indicated.
- Yield: 6 (1 cup) servings.
- Per serving: About 124 cal, 2 g pro, 27 g car, 1 g fat, 3 mg chol, 38 mg sod.

Melon Freeze

- 2 cups cubed honeydew melon, frozen
- $\frac{3}{4}$ cup honeydew melon flavor liqueur
- $\frac{1}{2}$ cup chilled gingerale
- 1 cup small ice cubes
- Vanilla ice cream, if desired

Place all ingredients except ice cream in blender jar. Cover and blend at LIQUEFY, pulsing 5 to 6 times, about 5 seconds each time, until smooth. Serve in glasses with small scoop of vanilla ice cream, if desired.

Yield: 4 (1 cup) servings.

Per serving: About 178 cal, 0 g pro, 28 g car, 0 g fat, 0 mg chol, 14 mg sod.

Frosty Chocolate Raspberry Latte

- $\frac{1}{8}$ cup hot water
- 1 tablespoon instant espresso powder
- $1\frac{1}{4}$ cups lowfat milk
- 2 to 3 tablespoons chocolate syrup
- 1 package (10 oz.) frozen raspberries in syrup, broken into chunks
- $2\frac{1}{2}$ cups light vanilla ice cream

Place water and espresso powder in blender jar; let stand 30 seconds. Add milk, chocolate syrup and raspberries to blender jar. Cover and blend at LIQUEFY until smooth, about 10 seconds. Add ice cream to blender jar. Cover and blend at LIQUEFY, pulsing 4 to 5 times, about 5 seconds each time, until smooth; scrape sides of blender jar, if necessary.

Yield: 4 (1 cup) servings.

Per serving: About 292 cal, 8 g pro, 54 g car, 5 g fat, 13 mg chol, 128 mg sod.

Lime Frosty

- 2 cups light vanilla ice cream
- $\frac{1}{8}$ cup lime juice
- $\frac{3}{4}$ cup lowfat milk
- 2 tablespoons powdered sugar
- 6 ice cubes
- 1 drop green food color, if desired

Place all ingredients in blender jar. Cover and blend at LIQUEFY until smooth, about 30 to 45 seconds; scrape sides of blender jar, if necessary.

Yield: 4 ($\frac{3}{4}$ cup) servings.

Per serving: About 162 cal, 6 g pro, 27 g car, 4 g fat, 9 mg chol, 91 mg sod.

Raspberry Chocolate Pie

DESSERTS

Crust

- 24 *chocolate cookie wafers*
- $\frac{1}{4}$ *cup melted margarine*

Break cookies into large pieces and place in blender jar. Cover and blend at LIQUEFY, pulsing 2 or 3 times, about 10 seconds each time, until finely chopped.

In bowl, combine cookie crumbs and margarine; reserve 2 teaspoonfuls. Press remaining mixture into bottom and up sides of a standard 9-inch pie plate (not deep-dish).

Filling

- $\frac{1}{4}$ *cup water*
- 1 *package (.3 oz.) sugar-free raspberry gelatin*
- 1 $\frac{1}{2}$ *cups frozen raspberries*
- 1 *container (8 oz.) nonfat raspberry yogurt*
- $\frac{1}{2}$ *cup lowfat cottage cheese*

In small saucepan, combine water and gelatin; let stand to soften, about 30 seconds. Heat over medium heat until gelatin is dissolved; stir occasionally. Pour into blender jar. Add remaining ingredients. Blend at LIQUEFY about 30 to 45 seconds.

Pour into pie crust. Sprinkle with reserved crumbs. Refrigerate until set, about 1 to 2 hours.

Yield: 8 servings.

Per serving: About 155 cal, 5 g pro, 16 g car, 8 g fat, 6 mg chol, 184 mg sod.

Pots de Creme

- 1 *cup semi-sweet chocolate chips*
- $\frac{1}{4}$ *cup egg substitute or 1 pasteurized egg, beaten*
- $\frac{1}{2}$ *teaspoon vanilla*
- $\frac{3}{4}$ *cup evaporated milk Sweetened whipped cream or whipped topping, if desired*

Place chocolate chips, egg substitute, and vanilla in blender jar. Heat evaporated milk to boiling and pour over ingredients. Cover and blend at LIQUEFY until chocolate chips are melted and mixture is smooth, about 30 to 45 seconds; scrape sides of blender jar, if necessary.

Pour into small cups. Refrigerate until set, about 4 to 6 hours. Serve with whipped cream, if desired.

Yield: 4 (about $\frac{1}{3}$ cup) servings.

Per serving: About 211 cal, 6 g pro, 26 g car, 12 g fat, 2 mg chol, 72 mg sod.

Orange Sorbet

- 1 can (11 oz.)
mandarin oranges,
drained
- 1 cup water
- 1 can (6 oz.) frozen
orange juice
concentrate
- $\frac{1}{4}$ cup powdered sugar
- 1 tablespoon fresh
lemon juice

Place all ingredients in blender jar. Cover and blend at LIQUEFY, about 15 to 20 seconds. Pour into freezer container and freeze until almost set, about 3 to 4 hours. Scrape into blender jar. Blend at LIQUEFY until smooth, about 1 minute.

Pour into freezer container. Freeze until hard, about 5 to 6 hours.

Yield: 4 ($\frac{1}{2}$ cup) servings.

Per serving: About 128 cal, 2 g pro, 31 g car, 0 g fat, 0 mg chol, 3 mg sod.

Mocha Mousse

- 2 tablespoons cold
water
- 1 envelope unflavored
gelatin
- 2 tablespoons instant
coffee granules
- $\frac{1}{2}$ cup warm water
- $\frac{3}{8}$ cup semi-sweet
chocolate chips
- 1 tablespoon sugar
- $\frac{1}{4}$ teaspoon vanilla
- $\frac{3}{4}$ cup crushed ice,
drained
- $\frac{1}{2}$ cup heavy cream

Pour cold water into blender jar; add gelatin and let set about 15 to 20 seconds. Add coffee granules and boiling water. Cover and blend at STIR until gelatin is dissolved, about 20 to 30 seconds. Add chocolate chips, sugar, and vanilla. Blend at LIQUEFY until mixture is smooth, about 20 to 30 seconds. Pour in crushed ice and cream. Blend at LIQUEFY, pulsing 3 to 4 times, about 5 seconds each time, until mixture begins to thicken and ice is completely blended.

Pour into dessert dishes. Refrigerate until set, about 20 to 30 minutes.

Yield: 4 (about $\frac{1}{2}$ cup) servings.

Per serving: About 262 cal, 4 g pro, 23 g car, 19 g fat, 41 mg chol, 21 mg sod.

Apple Pie

<i>¼ cup egg substitute or 1 egg</i>	Coat a 9-inch pie plate with no-stick spray. Place egg, margarine, evaporated milk, sugar, cornstarch, cinnamon, nutmeg, and lemon extract in blender jar. Cover and blend at LIQUEFY 15 to 30 seconds; scrape sides of blender jar, if necessary. Add apples. Cover and blend at CHOP until apples are finely chopped, about 15 to 20 seconds.
<i>3 tablespoons margarine</i>	
<i>3 tablespoons evaporated skim milk</i>	
<i>½ cup sugar</i>	
<i>2 tablespoons cornstarch</i>	
<i>½ teaspoon cinnamon</i>	
<i>½ teaspoon nutmeg</i>	
<i>¼ teaspoon lemon extract</i>	
<i>3 cups coarsely chopped, peeled apples</i>	
<i>Cinnamon, if desired</i>	

Pour into pie plate and sprinkle with additional cinnamon, if desired. Bake at 350°F for 35 to 40 minutes, or until knife inserted in center comes out clean.

Yield: 6 servings.

Per serving: About 185 cal, 2 g pro, 30 g car, 7 g fat, 0 mg chol, 96 mg sod.

Ricotta Cheesecake Pie

Crust

- 16 to 18 graham cracker squares*
- 3 tablespoons melted margarine*

Break graham cracker squares into large pieces and place in blender jar. Cover and blend at LIQUEFY, pulsing a few times, about 3 seconds each time, until finely chopped.

In bowl, combine graham cracker crumbs and margarine. Press crumb mixture firmly into bottom and up sides of a 9-inch pie plate. Chill.

Filling

- 1 cup light ricotta cheese*
- 1 package (8 oz.) neufchatel cheese, softened*
- ½ cup egg substitute or 2 eggs*
- ½ cup sugar*
- 3 tablespoons fresh lemon juice*
- ½ teaspoon vanilla*

Place filling ingredients in blender jar. Cover and blend at LIQUEFY about 30 seconds.

Pour into crust. Bake at 350°F for 25 to 30 minutes, or until knife inserted near center comes out clean. Cool 30 minutes at room temperature. Then refrigerate until well chilled, about 6 to 8 hours.

Yield: 8 servings.

Per serving: About 266 cal, 9 g pro, 26 g car, 15 g fat, 26 mg chol, 313 mg sod.



FOR THE WAY IT'S MADE.™

® Registered Trademark/™Trademark of KitchenAid, U.S.A.