

This Owner's Manual is provided and hosted by [Appliance Factory Parts](#).



Littermaid LME9000MB Owner's Manual

[Shop genuine replacement parts for Littermaid
LME9000MB](#)



[Find Your Littermaid Small Appliance Parts - Select From 15 Models](#)

----- Manual continues below -----

ADVANCED AUTOMATIC Self-Cleaning Litter Box

IDEAL FOR EXTRA-LARGE CATS OR MULTIPLE CAT HOUSEHOLDS



Register your product online at www.prodprotect.com/applica,
for a chance to WIN \$100,000!
For US residents only



USA/Canada 1-800-LITMAID

(548-6243)

www.littermaid.com

Accessories/Parts (USA/Canada)

1-800-738-0245

Model

LME9000MB

Please Read and Save this Use and Care Book

WELCOME TO THE FAMILY!

Congratulations on your purchase of the LitterMaid® Advanced Automatic Self-Cleaning Litter Box. This product is designed to make caring for your cat a simpler, less time-consuming process.

OPERATING INSTRUCTIONS FOR THE LITTERMAID® SELF-CLEANING LITTER BOX

- Cat enters the unit; once he/she leaves, the sensors are triggered, setting the timer for the cleaning cycle (sensors need to be blocked for at least 5 seconds).

Important: Unit will not start a cleaning cycle while cat is in the box.

- As soon as the cat leaves the litter box, the sensors activate the 10-minute countdown and the ionic air cleaner.
- The ionic air cleaner stays on during the countdown and the cleaning cycle.
- After the 10-minute countdown, the cleaning cycle starts and the rake scoops out the waste clumps.
- If the cat reenters and leaves the litter box before the initial 10 minutes have elapsed, the timer will automatically reset and delay the beginning of the cleaning cycle for an additional 10 minutes.

Note: Rake stops and reverses if the safety bar touches any object that has gotten behind the rake while it is returning to its home position.

- Rake opens waste receptacle compartment cover and deposits clumps into the waste receptacle.

Note: Rake stops and reverses if it encounters an obstacle larger than 35 lb. It will try five times to clear the obstacle. If obstacle is not cleared, the rake reverses back to the home position and the green POWER LED blinks (1 time per second).

- Sealed disposable waste receptacle allows for safe and easy disposal of waste when full.
- If the sleep timer is activated, the rake will not cycle for 9 hours from the set sleep mode time (the ionic air cleaner will automatically turn on every hour for 10 minutes).

Important: When the On/Off button is in the Off position it only disables the rake function.

IMPORTANT SAFEGUARDS

Instructions pertaining to a risk of fire, electric shock or injury to persons.

WARNING: When using electric appliances, basic precautions should always be followed including the following:

1. Read all the instructions before using the appliance.
2. To reduce the risk of injury, close supervision is necessary when an appliance is used near children.
3. Do not contact moving parts.
4. Only use attachments recommended or sold by the manufacturer.
5. Do not use outdoors.
6. To reduce the risk of electric shock, do not put LitterMaid® Advanced Automatic Self-Cleaning Litter Box in water or other liquid. Do not place or store appliance where it can fall or be pulled into a tub or sink.
7. **NOT INTENDED FOR USE WITH KITTENS UNDER SIX MONTHS.**
8. Not intended for use by handicapped, incapacitated or very old cats that might experience difficulty in entering or leaving the litter box.
9. **PREGNANT WOMEN and IMMUNE-DEFICIENT PEOPLE** should avoid contact with cat waste at all times.
10. **CAUTION: THIS IS NOT A TOY.** The LitterMaid® Advanced Automatic Self-Cleaning Litter Box is a precision-operated appliance. Should the rake become jammed during cleaning, **THIS UNIT CONTAINS A MECHANISM THAT WILL AUTOMATICALLY STOP, REVERSE AND RESTART THE CLEANING OPERATION.**
11. For cat use only. The LitterMaid® Advanced Automatic Self-Cleaning Litter Box is intended solely for the safe elimination of cat waste. **DO NOT ATTEMPT TO USE THIS PRODUCT FOR ANY OTHER PURPOSE.**
12. Never allow small children to play in or around this device.
13. Please read all directions in this manual carefully prior to operating this product.

**Intended for Household Use Only.
SAVE THESE INSTRUCTIONS.**

Product may vary slightly from what is illustrated.

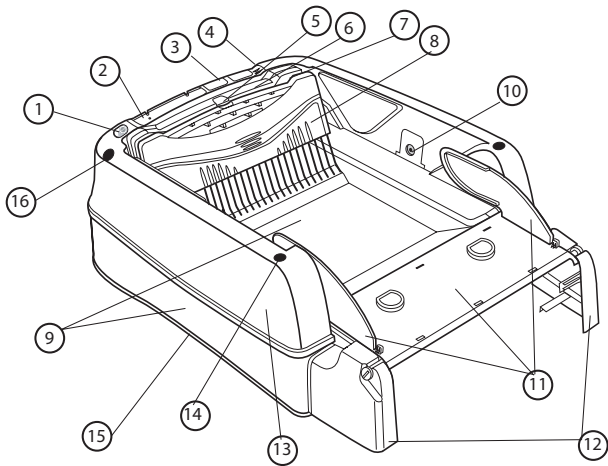

- 1. ON/OFF button.
Important: When the On/Off button is in the Off position it only disables the rake function.
- 2. Timer
- 3. Warranty board
- † 4. Battery compartment cover (Part# LME9000MB-01) (batteries not included)
- 5. Blue LED ionizer light
- 6. Ionic air cleaner
- 7. Motor housing
- † 8. Removable rake (Part# LME9000MB-02)
- † 9. Litter tray (Part# LME9000MB-03)
- 10. Sensors (both sides)
- † 11. Waste receptacle compartment cover with flaps (Part# LME9000MB-04)
- 12. Receptacle supports
Right (Part# LME9000MB-06) and Left (Part# LME9000MB-05)
- 13. Top housing
- 14. Plug holes for Plug 2 (1 each side)
- 15. Cutout handle (1 each side)
- 16. Plug holes for Plug 1 (1 each side)
- † Consumer replaceable/removable parts

Accessories

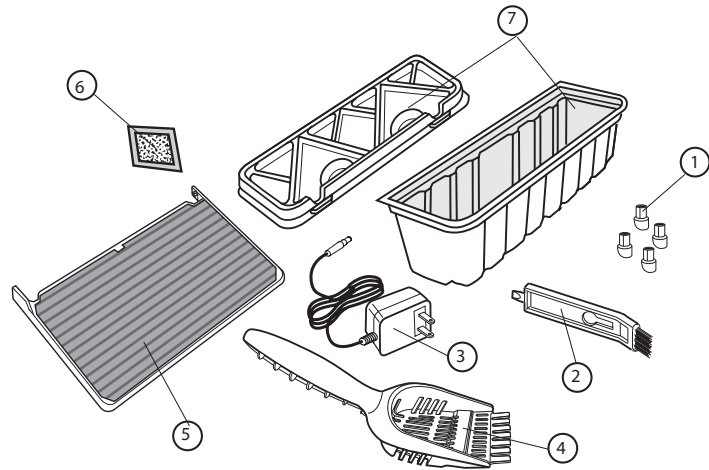

- † 1. Tent plugs type 1 and 2 (4) set (Part# LME9000MB-07)
- † 2. Cleaning brush (Part# LME9000MB-08)
- † 3. AC adapter (Part# LME9000MB-09)
- † 4. LitterMaid® triple-action tool (Part# LME9000MB-10)
- † 5. Paw cleaning ramp (LME9000MB-11)
- † 6. Carbon Filters (4 included) (Part# LMF200) (12 pk.)
- † 7. Disposable waste receptacle (4 included)
(12 pk.) (Part# LMR200)
(18 pk.) (Part# LMR300)
- † Consumer replaceable/removable parts

Timer

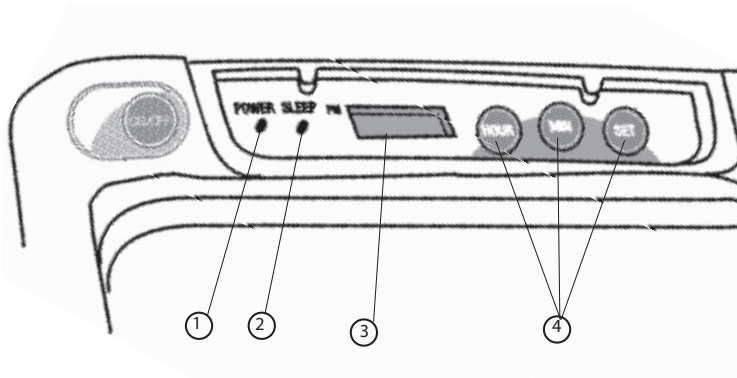

1. Green LED POWER indicator light
2. Red LED SLEEP indicator light
3. Digital clock
4. Time/Programming buttons

Other LitterMaid® Accessories

Check our online service for parts and accessories at www.littermaid.com or call 1-800-548-6243

	Model #
LitterMaid Kitty Kabana™ litter box cover (white)	LMT200
LitterMaid Elite™ litter box cover (white)	LMT250
LitterMaid® litter box carpet	LMC100
LitterMaid® hard clumping cat litter	LML100
Disposable waste receptacles (12 pk.)	LMR200
Disposable waste receptacles (18 pk.)	LMR300
Carbon filters (12 pk.)	LMF200

Setup Instructions

No Tools Required for Setup

- Unpack the pieces of the unit listed below.
- Peel off the protective tape on the battery compartment.
- Cut or remove the tie restraints on the underside of unit.

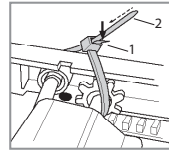

1. Press down.
2. Slide through.

Before getting started be sure you have all of the following contents.

Litter tray	1
Top housing	1
Waste receptacle compartment supports	2
Waste receptacle compartment cover	1
Rake	1
AC adapter (packed in styrofoam)	1
Disposable waste receptacles	4
Carbon filters	4
LitterMaid™ triple-action tool	1
Use and care manual	1
Tent type 1 and 2 Plugs	4
Cleaning brush (packed with disposable waste receptacles)	1
Quick Start Sheet	1
Paw-cleaning ramp	1

Assembly



1. Slide receptacle supports (marked L (left) and R (right)) into grooves on the bottom tray until they lock into place (A).

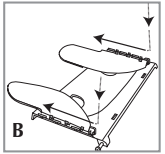

2. Place both left and right flaps flat on top of the waste receptacle compartment panel.
3. Push the flaps in and up until they click into place (B).

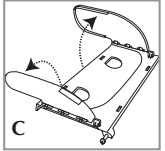

4. Lift the flaps until they lock into place (C).

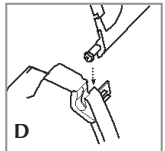

5. Snap each pivot of the waste receptacle compartment cover, one at a time, into notches in the receptacle supports (D).
6. Open waste receptacle compartment cover.

Important: Waste receptacle compartment cover must be opened to remove and install top housing.

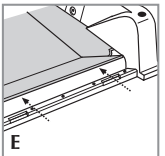

7. Lift top housing. Angle into position bracket end of top housing under tray ledge. **Important: 5 black tabs of the tray should be on top of the grey bar in front of the top housing (E).** Bring the other end of top housing down so that it snaps into place. Check to be sure top housing is positioned securely on the tray. If positioned correctly, you will not be able to read writing on silver tray ledge.

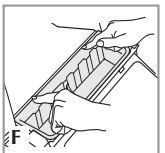

8. **Insert waste receptacles.**
 - Open waste receptacle compartment cover.
 - Insert a disposable waste receptacle into the waste receptacle compartment.
 - Insert the edge of the waste receptacle in an inclined position and place it between the edge of the tray and the bar of the top housing (F).

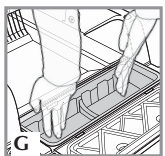

- Press the waste receptacle down into position (G).
- There should be no gap between the unit and the waste receptacle.

7

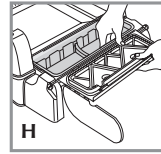

- Attach the waste receptacle lid by inserting the push tabs into the round holes. To secure, press on positions indicated (H).

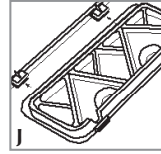

Make sure lid edges are under the cover tabs (J).

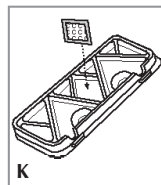

9. Install carbon filter.

- Peel off the paper strip on the carbon filter to expose the adhesive.
- Place filter adhesive-side down in the diamond-shaped insert in the center of the waste receptacle lid (K). Close the waste receptacle compartment cover.

10. Fill the LitterMaid® litter box with litter to just below the Full Line marked inside of litter tray

Important: Use only hard clumping litter. Do not use non-clumping litter, crystal or pearl-like litters.

Recommended Hard Clumping Litters

- LitterMaid™ Hard Clumping Cat Litter
- World's Best Cat Litter™
- ARM & HAMMER® Super Scoop® The Baking Soda Clumping Litter
- Fresh Step® Scoopable Premium Cat Litter
- EVER CLEAN® Premium Clumping Litter

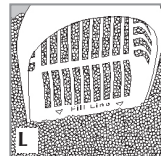

Do not overfill the unit or it will not operate properly.

- Use the Fill Line on the LitterMaid® triple-action tool to check that the litter is at the correct level in the center of the unit (L).

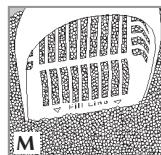

The LitterMaid® Triple-Action Tool

This handy 3-way tool helps you:

- Measure the level of litter (M).

8



- Assists in cleaning the rake in case it's needed (N).

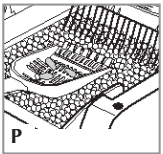

- Aids in the removal of small waste particles (P).
11. **Install paw cleaning ramp:**
- The paw-cleaning ramp has two pivot pins that fit into holes on the sides of the waste receptacle compartment cover.
 - Position the paw-cleaning ramp with carpet-side facing up.

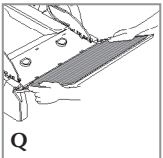

- Insert the pivot pins into the holes (Q).
- Tug slightly on the ramp to ensure that it is firmly in place.

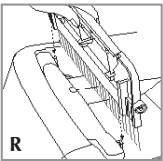

Install rake

12. Align tracks on back of rake (each end) and slide into grooves on motor housing (R).

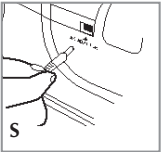

13. Remove the AC adapter from where it is packed in the styrofoam and plug it into the unit (S).
- Plug the cord into a standard electrical wall outlet.
 - Press the ON/OFF button to turn unit ON. The rake will automatically run through its first cleaning cycle and smooth out the litter.

Important: When the On/Off button is in the Off position it only disables the rake function.

14. Place the 4 tent plugs into the 4 holes on top housing.

Note: Always use both hands to move LitterMaid® litter box by holding handle cutouts located on each side of the tray.

OPTIONAL PROGRAMMABLE TIME FUNCTION: The timer function allows you to deactivate the unit for up to 9 hours at your convenience. Once the time is up, it will restart again and run one cycle. To program the timer, you must first set the clock.

Setting the clock

1. Set the clock to the time of day by pressing the hour then minute button.

Note: If setting P.M., be sure light in the upper left corner of the display is lit. The LED continues to blink 12:00 until the clock is set.

Programming the Timer

Sleep mode deactivates the cleaning cycle for a period of 9 hours. During this time the ionic air cleaner automatically turns on for 10 minutes every hour to freshen the air.

After 9 hours the unit will perform one litter raking cycle and then resume normal operation. The 9-hour sleep mode and the 15-hour normal operation repeat at set time every 24 hours.

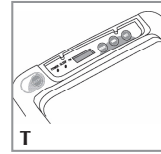

To Program the Sleep Mode Timer (T)

1. Set the clock to the time of day by pressing the hour then minute button.

Note: If setting P.M., be sure light in the upper left corner of the display is lit. The LED continues to blink 12:00 until the clock is set.

2. Press the SET button on the control panel to begin programming.
3. Sleep mode red LED starts blinking.
4. Press the HOUR and MINUTE button (light indicating P.M. is in the upper left corner of the LED display) to set the time you want the sleep mode to begin (for example, if you set the time for 10:00 P.M. the unit remains in the sleep mode until 7:00 A.M. (9 hours).
5. Sleep mode time is automatically accepted if no buttons are pressed for 3 seconds or more.
6. Sleep mode red LED stops blinking and red LED is not lit.
7. Sleep mode is now set but is not activated.

To Activate Sleep Mode

1. Press and hold the set button.
2. Steady red light comes on to indicate that the sleep mode is activated.

To Deactivate Sleep Mode

1. Sleep mode must be activated (red LED lit) to be deactivated.
2. Press the SET button, steady red LED is no longer lit.

Ionic Air Cleaner

- As soon as the cat leaves the litter box, the sensor activates the 10-minute countdown and the ionic air cleaner.
- The ionic air cleaner stays on during the countdown and the cleaning cycle.
- If the sleep timer is activated the rake will not cycle for 9 hours from the set sleep mode time but the ionic air cleaner will automatically turn on every hour for 10 minutes.

Optional Items:

For more information, call 1-800-738-0245 or visit our website: www.littermaid.com

Helpful Information

If you need to acclimate your cat to the LitterMaid® Advanced Automatic Self-Cleaning litter box, refer to "Acclimating Your Cat" in this use and care book.

Unit will work without setting the clock when unit is turned on.

If your unit is not working properly, refer to "Troubleshooting" in this use and care book.

Batteries (We recommend using batteries only as a back-up):

- Push up on center ridges to open battery compartment door.
- Remove the battery door.
- Follow the diagram in the compartment to install 8 AA Alkaline cell batteries (batteries not included).

Just as your alarm clock continues to run on batteries if there is a power failure, the LitterMaid® litter box will continue to operate as long as batteries are installed. Change the batteries periodically.

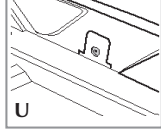

Sensors

Sensors (located on interior side panels) must be kept clean. Wipe sensors with a soft, dry cloth to keep them dust free (U).

LED operation, function and why they blink:

Green on control panel	Power LED indicator is lit when power to the unit is on. LED is located on control panel.
Blinking green on control panel	LED blinks (2 times per second) indicating batteries are low.
	LED blinks (1 time per second) when the rake assembly has encountered a blockage.
Blue on ionizer	Ionic air cleaner LED (behind the rake) is only lit when the ionizer is operating.
Red on control panel	Sleep timer LED is continually lit when sleep mode is activated.
Blinking red on control panel	Occurs during the sleep mode programming.

ACCLIMATING YOUR CAT

To acclimate your cat to the new LitterMaid® Advanced Automatic Self-Cleaning litter box, we suggest following this procedure.

- Place the LitterMaid® unit next to your old litter box.
- Set it to run automatically by pressing the ON/OFF button ON.
Important: When the On/Off button is in the Off position it only disables the rake function.
- Do not clean out the old litter box. Cats prefer to use a clean box, and the LitterMaid® litter box will always be clean.

- If your cat is shy, do not operate the LitterMaid® litter box automatically for 2 to 3 days. Do it manually by pressing the ON/OFF button once and then turning it off.
- Manually activate the LitterMaid® litter box 2 to 3 times a day for the first 2 to 3 days, to let your cat get used to going into the LitterMaid® litter box, and how it sounds and works; you can then set it to clean automatically.
- As soon as your cat is acclimated to the LitterMaid™ litter box, set it to clean automatically. Press the ON/OFF button to ON and remove the old litter box.

Note: Do not place your LitterMaid® litter box in a wet environment or in direct sunlight. **Do not use outdoors or on patios.**

Care and Cleaning

This product contains no user serviceable parts. Refer service to qualified service personnel.

Sensor Covers

The two sensors located on the interior side panels are protected by sensor covers that need to be kept dust free. After changing or adding litter, wipe each sensor with a soft, dry cloth to remove dust.

Litter Tray

Use only hard clumping litter. Low quality or non-clumping litter will impair performance and may damage your unit.

To empty and clean litter tray:

- Check to make sure rake is in home position.
- Press the ON/OFF button to turn unit OFF.
Important: When the On/Off button is in the Off position it only disables the rake function.
- Unplug unit and remove batteries to prevent accidental activation of the unit.
- Remove the waste receptacle.
- Remove the rake.
- Remove the top housing.
- Dispose of the used litter. To ensure proper disposal of litter, follow manufacturer's instructions on litter package. Wipe the litter tray with a damp cloth. If further cleaning is necessary, the litter tray can be fully immersed in water and washed with a mild detergent.

Important: Do not soak or immerse the top housing in water. To clean wipe with damp cloth. Dry the unit completely before reassembling.

- Before reassembling, spray litter tray surface with nonstick cooking spray or silicone spray, and wipe with a soft, dry cloth. This will help to prevent waste clumps from adhering to the surface of the tray.

Removing Disposable Waste Receptacle

We recommend avoiding contact with waste material. Wear rubber or latex gloves when handling used disposable waste receptacle.

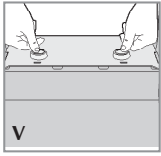

- Depress the two push tabs in the waste receptacle compartment cover (**V**) to detach the disposable waste receptacle lid from the waste receptacle compartment cover.
- Lift the compartment cover, exposing the closed disposable waste receptacle assembly.
- Press in on four corners of lid to secure lid to the waste receptacle, pull up from both sides making sure to hold lid and receptacle together; lift out and dispose (**W**).



Disposable waste receptacles are available in packages of 12 or 18 and may be purchased through your local retailer, by visiting us at our website at www.littermaid.com, or by calling us at 1-800-738-0245. We will be happy to assist you in any way we can.

Rake Removal & Cleaning

Removing the rake:

The rake can be removed for easy cleaning.

We recommend wearing rubber or latex gloves when handling the soiled rake.

- Be sure rake is in the home position and unit is turned off.
- Grasp rake ledge underneath logo and slide up and off of unit.
- Clean rake with a soft cloth using warm water and mild detergent. Do not use scouring pads or harsh or abrasive chemicals. Spray rake lightly with nonstick cooking spray or a silicone spray before reinstalling.

Note: Rake may be cleaned while installed by using the LitterMaid® triple-action tool.

Paw-Cleaning Ramp:

The carpet is made of 100% polypropylene and latex foam.

To Clean:

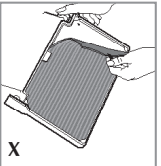

- Remove mat by gently pulling on the fabric strip provided (**X**).
- The mat is held in place by 5 tabs and will remove easily.
- Remove and clean carpet by using a vacuum cleaner.
- To return it to its original position, reinsert carpet under the tabs. It is not necessary to remove the plastic ramp to clean the mat.

Note: For small stains, moisten a sponge with mild detergent and cold water; wipe to clean. Do not use soaps or chemical cleaners, as they may be harmful to your cat.

Caution: Do not place carpet in washer or dryer. Do not vacuum carpet when it is wet.

Troubleshooting

Rake continues to go through cleaning cycles.

Probable Cause:

- Too much litter in the litter box is causing excess litter to collect **behind** the rake, preventing it from returning to home position or there is an obstacle in **front** at the rake. If the rake cannot move an obstacle during the cleaning cycle, the unit will go through a cleaning cycle up to five times in an attempt to clear the obstacle. If unsuccessful, the rake will return to its home position, and the green light will blink slowly (1 time per second), indicating that the rake has encountered an obstacle it cannot move.

Solution:

1. Press the ON/OFF button to turn unit OFF.
Important: When the On/Off button is in the Off position it only disables the rake function.
2. Clear the obstacle.
Be sure litter in tray is just below the "Full Line". Level litter on litter tray evenly and use the LitterMaid® triple-action tool to measure the level of the litter in the center of the unit. Full Line will not be visible if tray is overfilled.
3. Press the ON/OFF button ON.
4. The rake will run through a complete cleaning cycle. When cycle is finished, the unit is ready for use.

Unit does not operate 10 minutes after cat leaves.

Probable Cause:

- Dusty sensors

Solution:

1. Wipe each sensor with a soft, dry cloth.
2. Press the ON/OFF button to turn unit OFF.
Important: When the On/Off button is in the Off position it only disables the rake function.
3. Press the ON/OFF button ON.
4. Unit will run through a cleaning cycle.

Unit does not completely clean litter box.

Probable Cause:

- Low-quality litter.

Solution:

1. Do not use non-clumping, crystal or pearl-like litter.
2. Use only hard clumping litter.

Unit does not operate when you press ON/OFF button to turn unit ON.

Important: When the On/Off button is in the Off position it only disables the rake function.

Probable Cause:

- Power outage
- Faulty or non-activated outlet
- Old batteries

Solution:

- Check batteries and outlet
- Use batteries in case of power outage
- Switch to battery power

Probable Cause:

- Incorrectly installed or dead batteries. Change the batteries once yearly (batteries should only be used as backup).

Solution:

1. Press the ON/OFF button OFF.
2. Open battery compartment; check to see that batteries are correctly installed.
3. Press the ON/OFF button ON. The unit should perform a whole cleaning cycle.
4. If unit does not operate, replace batteries with fresh ones and try again.
5. If unit does not operate with fresh batteries, try it with the AC adapter.
6. Green light should come on. If it does not, there is a problem with the AC adapter or batteries.

Probable Cause:

- AC adapter does not work

Solution:

Press ON/OFF button OFF and check the following:

Important: When the On/Off button is in the Off position it only disables the rake function.

1. The AC adapter plug is inserted fully into the input jack.
2. The power outlet is operating. (you may wish to double-check by plugging unit into another outlet).
3. Wait a few seconds and turn unit on again. Green light should come on and the unit should perform a complete cleaning cycle.
4. If unit still does not operate, press ON/OFF button OFF and unplug the AC adapter.
5. Operate the unit on battery power only.

Waste clumps adhere to the surface of the litter tray.

Probable Cause:

- Soiled litter tray surface

Solution:

(We recommend wearing rubber or latex gloves when handling waste).

1. Remove clumps with scoop and dump litter into another container.
2. Remove litter tray (refer to "Care and Cleaning" in this use and care book), clean with mild detergent, rinse and dry.
3. Spray litter tray surface with nonstick cooking spray or silicone spray, and wipe with a soft, dry cloth. This will help to prevent waste clumps from adhering to the surface of the tray. Wait until tray is completely dry and assemble unit again.

Power light fails to come on when ON/OFF button is pressed ON.

Important: When the On/Off button is in the Off position it only disables the rake function.

Probable Cause:

- Power outage or batteries are incorrectly installed or dead.

Solution:

1. Press ON/OFF button OFF then back ON.
2. Make sure there is power to the unit and/or fresh batteries are correctly installed.

If you can't solve the problem using this Troubleshooting section, more help is available by calling Customer Service at 1-800-LIT-MAID (548-6243).

Power light blinks slowly and continuously.

Probable Cause:

- Rake has encountered an obstacle it cannot remove. If the rake cannot move an obstacle during the cleaning cycle, the unit will go through a cleaning cycle up to five times in an attempt to clear the obstacle. If unsuccessful, the rake will return to its home position, and the green light will blink slowly (approximately every second), indicating that the rake has encountered an obstacle it cannot move.

Solution:

1. Press ON/OFF button OFF.
Important: When the On/Off button is in the Off position it only disables the rake function.
2. Use the LitterMaid™ triple-action tool to remove the obstacle.
3. Make sure that the rake teeth are clean and free of litter. Use the LitterMaid® tool to clean rake teeth.
4. Press ON/OFF button ON.

Power light blinks quickly.

Probable Cause:

- Batteries need replacing.

Solution:

Light will continue to blink until batteries are removed or until they are completely dead.

If SLEEP timer light is off.

Solution:

1. Check to be sure clock is set to the correct time.
2. Check to see if the sleep mode is set and activated, see "Programming the Sleep Timer " section.

If the rake is stuck in the center or dumping position.

Solution:

1. Press ON/OFF button OFF.
Important: When the On/Off button is in the Off position it only disables the rake function.
2. Unplug unit.
3. Remove batteries.
4. Clean unit (check track for litter).
5. Wipe sensors.
6. Put unit together and plug into AC power only and press ON/OFF button to turn unit ON for the automatic cycle.

If the Rake stops in the dump position

Press ON/OFF button OFF

Examine the Home position switch for obstruction (litter) preventing the switch lever arm from releasing

Carefully remove the obstruction using tooth pick or dental instrument

Press ON/OFF button turn unit ON

The rake should automatically return to the Home position.

If not, contact the Consumer Assistance Number for direction

If blue LED ionizer light is off.

Solution:

- Ionizer only turns on during 10-minute countdown and raking cycle.
- Ionizer only turns 10 minutes every hour during sleep mode.

NEED HELP?

For service, repair or any questions regarding your appliance, call the appropriate "800" number on the cover of this book. Do not return the product to the place of purchase. Do not mail the product back to the manufacturer nor bring it to a service center. You may also want to consult the website listed on the cover of this manual.

Two-Year Limited Warranty

(Applies only in the United States and Canada)

What does it cover?

- Any defect in material or workmanship; provided; however, Applica's liability will not exceed the purchase price of the product

For how long?

- Two years after the date of original purchase

What will we do to help you?

- Provide you with a reasonably similar replacement product that is either new or factory refurbished

How do you get service?

- Save your receipt as proof of the date of sale.
- Check our on-line service site at www.prodprotect.com/applica, or call our toll-free number, 1-800-548-6243, for general warranty service or If you need parts or accessories, please call 1-800-738-0245.

What does your warranty not cover?

- Damage from commercial use
- Damage from misuse, abuse or neglect
- Products that have been modified in any way
- Products used or serviced outside the country of purchase
- Glass parts and other accessory items that are packed with the unit
- Shipping and handling costs associated with the replacement of the unit
- Consequential or incidental damages (Please note, however, that some states do not allow the exclusion or limitation of consequential or incidental damages, so this limitation may not apply to you.)

How does state law relate to this warranty?

- This warranty gives you specific legal rights, and you may also have other rights that vary from state to state or province to province.

ARM & HAMMER® and Super Scoop® are registered trademarks of Church & Dwight Co., Inc.
EVER CLEAN® and Fresh Step® are registered trademarks of The Clorox Pet Products Company



R22007/4-26-122E

WIN

Copyright © 2008 Applica Consumer Products, Inc.
Made in People's Republic of China
Printed in People's Republic of China