

This Owner's Manual is provided and hosted by [Appliance Factory Parts](#).



Kenmore 79651022900 Owner's Manual

[Shop genuine replacement parts for Kenmore
79651022900](#)



[Find Your Kenmore Washer Parts - Select From 132 Models](#)

----- Manual continues below -----



SERVICE MANUAL

PEDESTAL

For washer and Dryer
Kenmore "

CAUTION : READ THIS MANUAL CAREFULLY TO DIAGNOSE
CORRECTLY BEFORE SERVICING THE UNIT.

MODEL : 796.5102#9##

1

INSTALLATION

NOTICE

The installer must have electrical and mechanical training and acceptable knowledge in the required work.

Safety is foremost--both your own and that of other people. Many important safety instructions are provided in this instruction and your appliance. Always read and observe all safety instructions.

⚠ WARNING

Excessive Weight Hazard

Two or more people may be needed to install and move the appliance and pedestal assembly. Do not allow children to play on the drawer. Do not step on the handle.

A stacked washer/dryer pair should never be mounted on a pedestal.

NOTE: A firm, solid floor is even more critical to a front-loading washer than to a top-loader. If your floor is wooden and /or frame construction, you may need to reinforce it. Front-loaders have substantially faster spin speed than top-loaders, causing greater vibration. If the floor is not solid, your washer will vibrate.

NOTE: If a drip pan must be used, take extra care to follow the instructions provided with the drip pan and make sure the leveling feet are adjusted for firm and even contact with the pan. Use of drip pans and failure to properly level the machine may result in increased vibration and noise during operation.

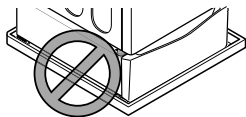

PEDESTAL INSTALLATION

- 1 Remove pedestal, installation hardware, and instructions from the shipping carton.
- 2 Before installing the pedestal, clean the area where the laundry will be located. Make sure the floor is clean and free of foreign objects. Dust, water, oil, detergent and so on could cause vibration due to bad contact of legs with floor.

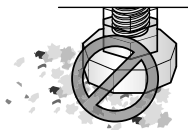

- 3 Level the pedestal on the clean area by adjusting the feet.

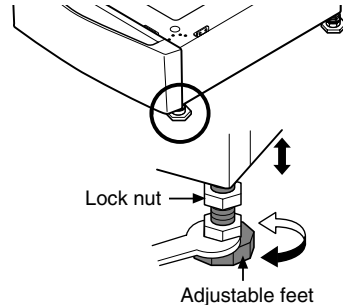

NOTE: Do not extend the legs no more than necessary to level the pedestal. The more the legs are extended, the more the machines will vibrate.

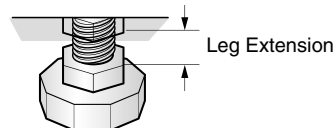

After the washer is leveled, tighten the lock nuts up toward the base of the washer using the wrench. All four lock nuts should be tightened.

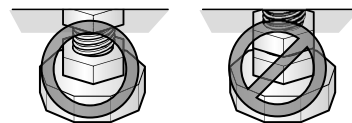

- 4 Position the washer or dryer on top of the pedestal.

NOTE: Because of the weight of the machines, two or more people may be needed.

NOTE: If the washer was previously installed, unplug it, disconnect the inlet hoses and drain hose. Drain the water from the hoses.

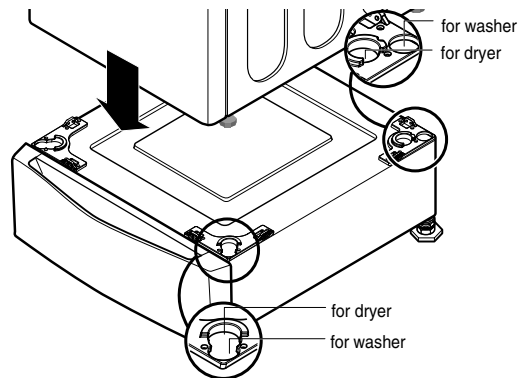

NOTE: The legs on the washer and dryer are not the same, so the recesses in the brackets on top of the pedestal are elongated. See the drawing above to identify the different locations for the washer and dryer legs. If the legs are not in the proper locations, the machine will not align properly and cannot be anchored to the pedestal.

1

INSTALLATION

WASHER INSTALLATION

(See page 4 for dryer instructions.)

- 5** Level the washer on the pedestal by adjusting the feet.

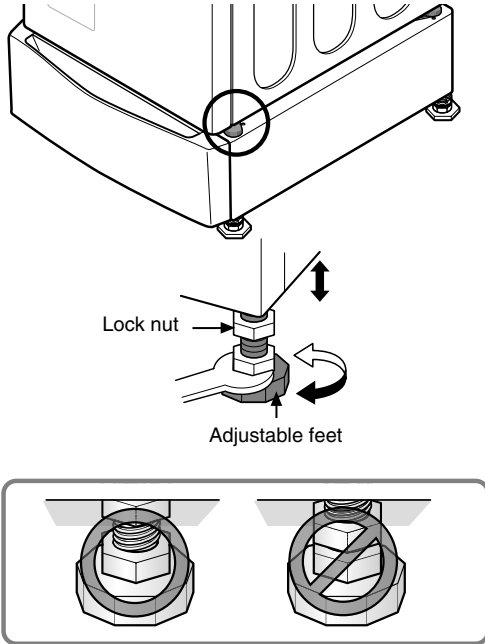

- 6** Check the alignment of the washer with the pedestal. Make sure the washer base brackets align with the brackets on the pedestal, then install 4 screws at each corner to securely attach the appliance to the pedestal.

NOTE: If the screws are not installed properly, noise and vibration may result.

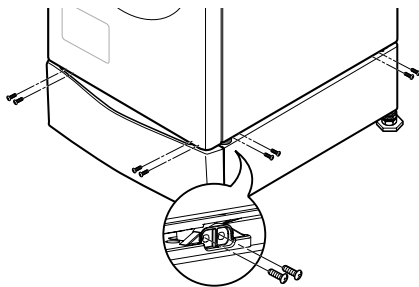

- 7** Move the washer to the desired place.

NOTE: The appliance and pedestal assembly must be placed on a solid and level floor for proper operation. Adjust the legs of the appliance and pedestal by turning with a wrench. Then, tighten the lock nut against the base of the pedestal with the wrench while holding the leg to make sure it does not turn.

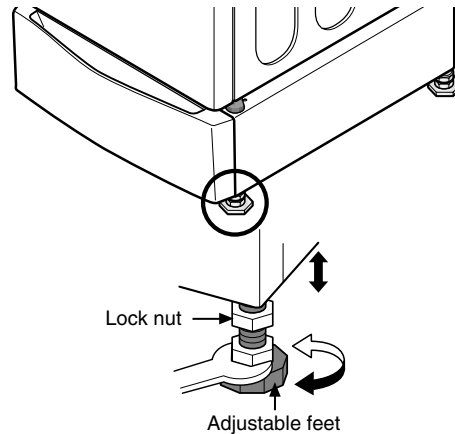

NOTE: Diagonal Check

Once the pedestal feet are adjusted, rock the washer very firmly in a diagonal direction. If one direction moves more than the other, readjust the front feet until both directions are even.

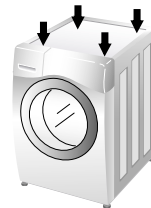

NOTE: To make sure that the washer is properly level, run the washer with a test load: place approximately 6 pounds of laundry in the machine. Then press POWER, press RINSE+SPIN, and then press the START/PAUSE button. (If the washer does not have the RINSE + SPIN, press EXPRESS WASH instead of pressing RINSE + SPIN.) Verify that the washer does not rock or vibrate excessively during the spin cycle. If the washer vibrates or shakes, adjust the leveling feet while the washer is spinning to minimize the vibration.

1

INSTALLATION

DRYER INSTALLATION

(See page 3 for washer instructions.)

- 5** Insert the T-clip of the 4 retainers into the dryer base as shown. Press up on the back of the clip and pull outward to lock into place.

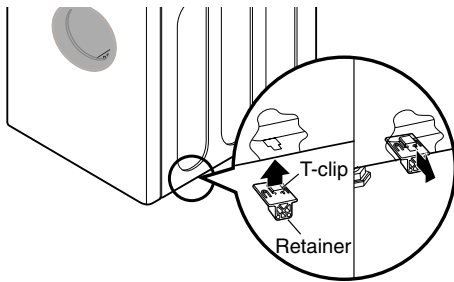

- 6** Position dryer on top of the pedestal.
- NOTE:** Because of the weight of the dryer, two or more people may be needed.

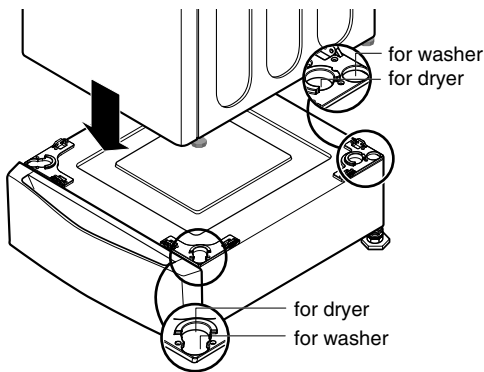

- 7** Make sure the holes on the pedestal align with the holes in the appliance, then install 4 screws at each corner to securely attach the appliance to the pedestal.

NOTE: If the screws are not installed properly, noise and vibration may result.

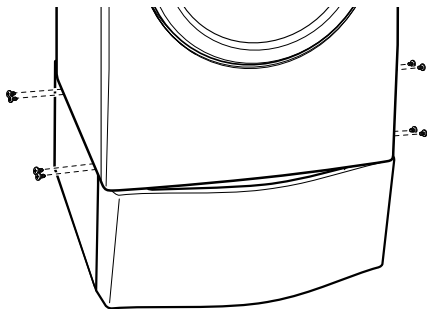

- 8** Move the dryer to the desired location.
- NOTE:** The appliance and pedestal assembly must be placed on a solid and level floor for proper operation. Adjust the legs of the pedestal using the wrench supplied. Tighten the lock nuts with the wrench.

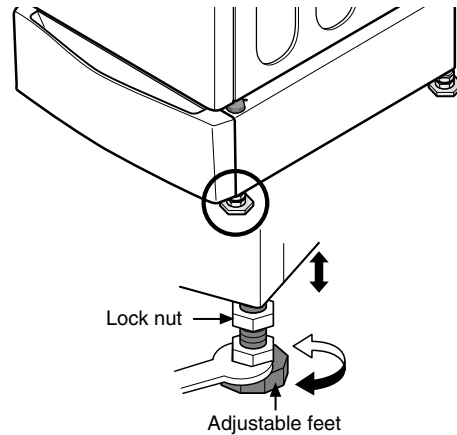

NOTE: If dryer was previously installed, uninstall it as follows:

A. Uninstalling an electric dryer:

- 1) Unplug the power supply cord.
- 2) Pull the dryer away from the wall enough to loosen the vent clamp. Loosen the clamp and carefully remove the exhaust vent from the dryer exhaust outlet.

B. Uninstalling a gas dryer:

- 1) Unplug power supply cord.
- 2) Turn off the gas supply.
- 3) Pull the dryer away from the wall enough to loosen the vent clamp. Loosen the clamp and carefully remove the exhaust vent from the dryer exhaust outlet.

2

DISASSEMBLY INSTRUCTIONS

- 1** Protect the floor with a large piece of cardboard. Lay the appliance on the cardboard. Be sure the cardboard is under the entire lower back of the appliance.

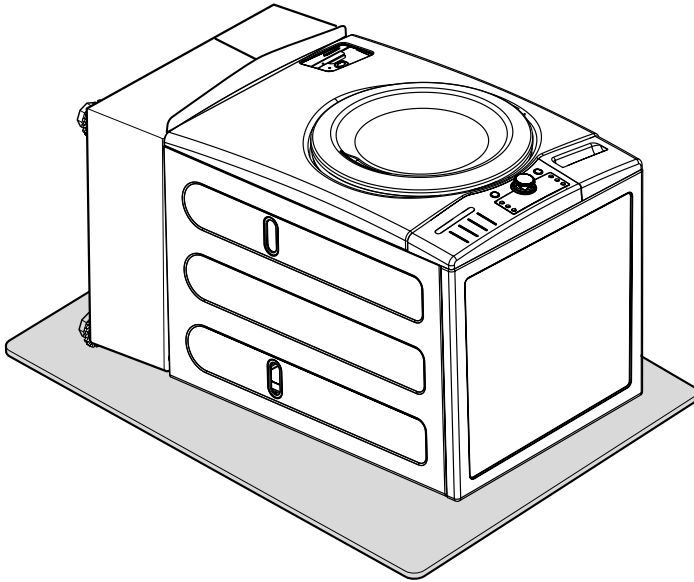

- 2** Open the drawer, and then remove the four (4) screws (two on each side) on both side of drawer.

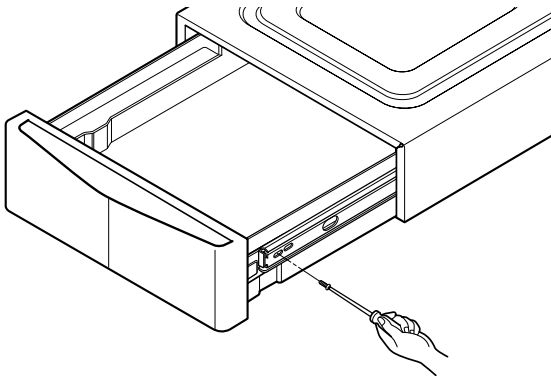

- 3** Pull up the drawer to disassemble.

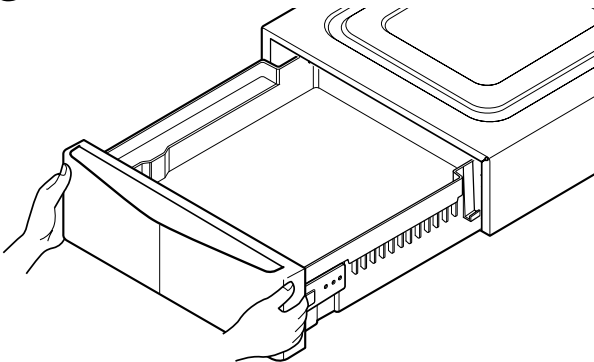

- 4** Remove three (3) screws on the drawer.

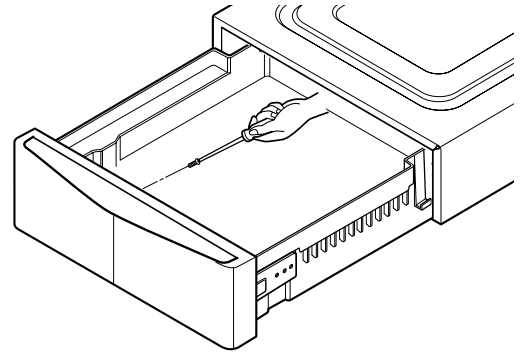

- 5** Remove two (2) screws on the either side of the drawer.

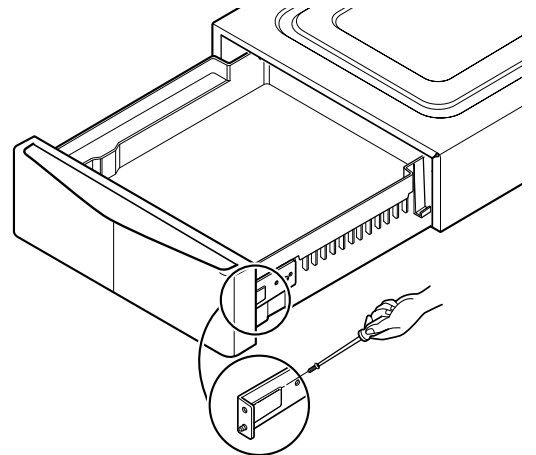

- 6** Remove six (6) screws on the front cover assembly.

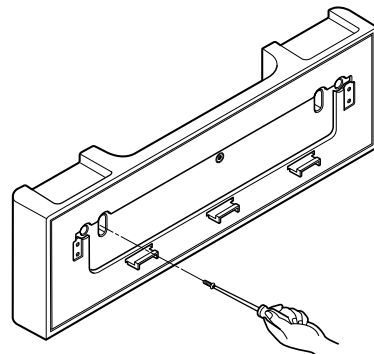

2

DISASSEMBLY INSTRUCTIONS

7 Loosen the leg using the wrench.(supplied)

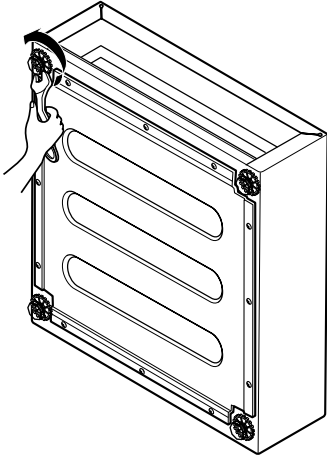

9 Remove four (4) screws (two on each side) on both side of slide.

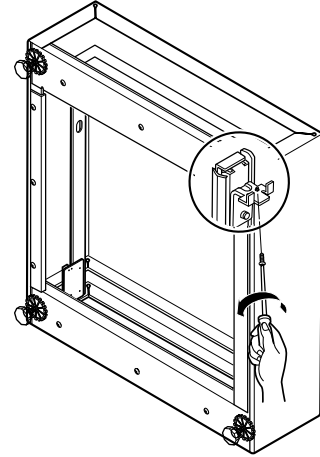

8 Remove twelve (12) screws on the bottom of the pedestal.

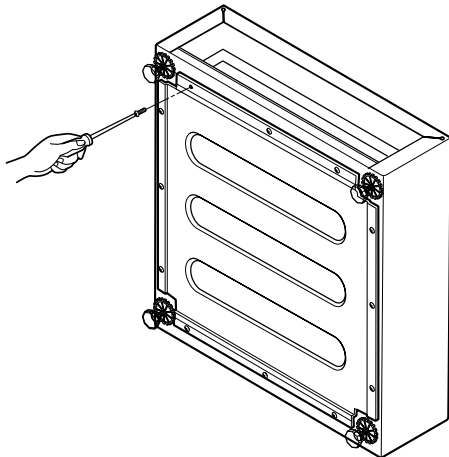

3

EXPLODED VIEW

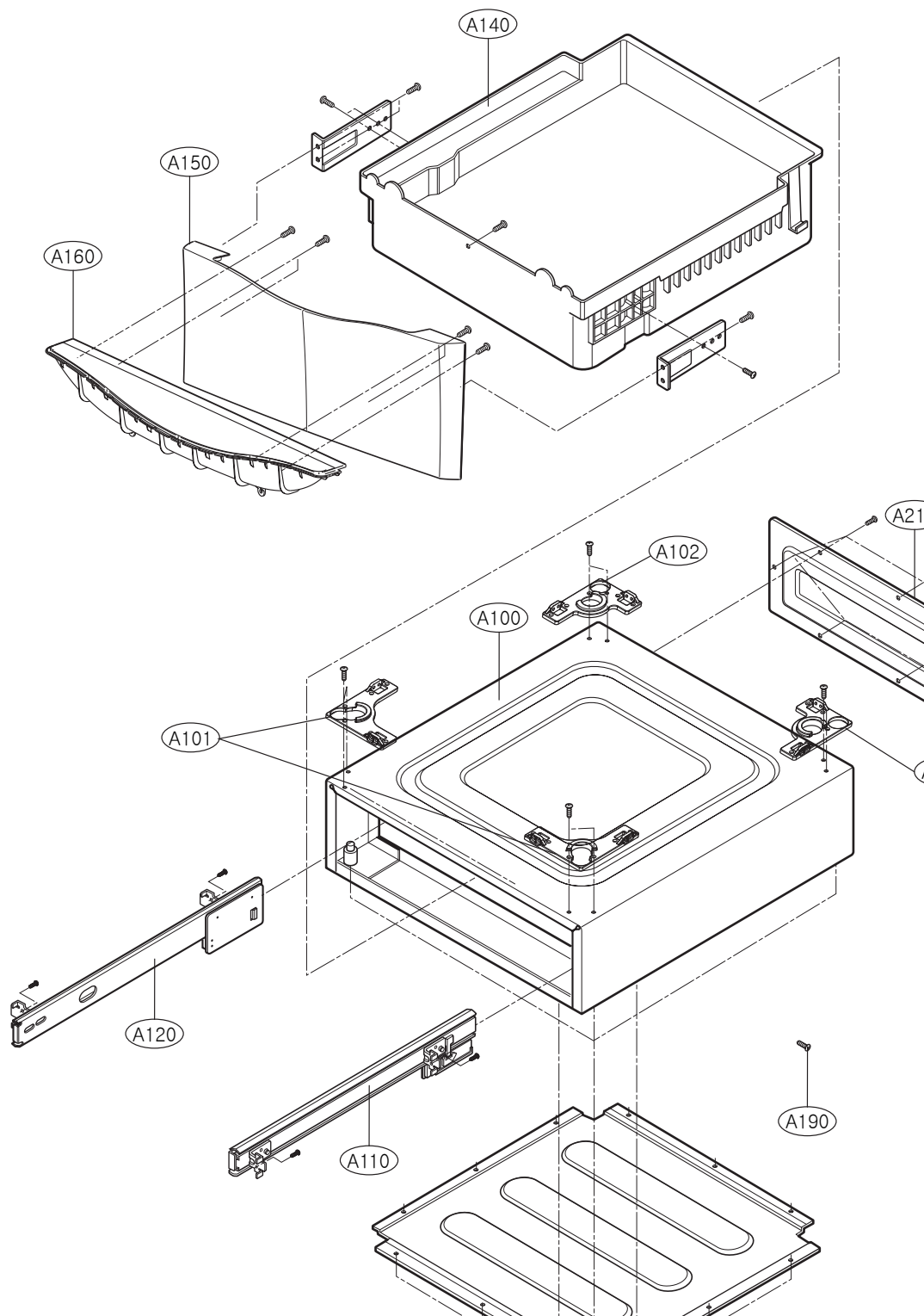



P/NO:MFL30599150