

This Owner's Manual is provided and hosted by [Appliance Factory Parts](#).



# KRUPS FMF5-14 Owner's Manual

[Shop genuine replacement parts for KRUPS FMF5-14](#)



[Find Your KRUPS Small Appliance Parts - Select From 175 Models](#)

----- Manual continues below -----

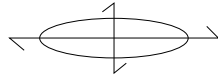

**KRUPS**

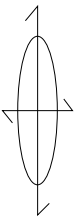
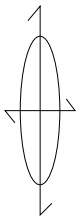

# IMPORTANT SAFEGUARDS

When using electrical appliances, basic safety precautions should always be followed to reduce the risk of fire, electric shock, and/or injury to persons including the following :

1. Read all instructions.
2. Do not touch hot surfaces. Use handles or knobs.
3. To protect against fire, electric shock and injury to persons, do not place cord, plugs or appliance in water or other liquid.
4. Close supervision is necessary when any appliance is used near children. Keep appliance out of reach of children.
5. Not intended for use by children.
6. Burns can occur from touching hot plate, hot metal parts, hot water or steam. Exercise caution.
7. Unplug from outlet when not in use and before cleaning. Allow to cool before putting on or taking off parts, before cleaning the appliance, and before storing.
8. Do not operate any appliance with a damaged cord or plug or after the appliance malfunctions, or has been damaged in any manner. Return appliance to the nearest KRUPS Service Center for examination, repair or adjustment.
9. The use of accessory attachments not recommended by KRUPS may result in fire, electric shock or injury to persons.
10. Do not use outdoors.
11. Do not let cord hang over edge of table or counter, or touch hot surfaces.
12. Do not place on or near a hot gas or electric burner, or in a heated oven.
13. To disconnect, turn the control to «off» then remove plug from wall outlet. Do not yank cord, instead grasp plug and pull to disconnect.
14. Do not use the appliance for other than intended use.
15. Scalding may occur if the lid is removed during the brewing cycles.

16. Do not pour liquids other than water and descaling solutions specified in this manual into the water tank.
17. Do not pour cold water into the water reservoir immediately after brewing. Allow the unit to cool down before refilling the reservoir.
18. This appliance is intended for household use only.

To reduce the risk of injury, do not drape cord over the counter top or table top where it can be pulled on by children or tripped over unintentionally.

## **SAVE THESE INSTRUCTIONS**

## **SHORT CORD INSTRUCTIONS**

- A. We do not recommend using an extension cord with this device.
- B. If an extension cord is absolutely necessary,
  - 1) the marked electrical rating of the extension cord should be at least as great as the electrical rating of the appliance,
  - 2) the longer cord should be arranged so that it will not drape over the counter top or table top where it can be pulled on by children or tripped over.
- C. This appliance has a polarized plug (one blade is wider than other). To reduce risks of electric shock, this plug is intended to fit into a polarized outlet only one way. If the plug does not fit fully into the outlet, reverse the plug. If it still does not fit, contact a qualified electrician. Do not attempt to modify the plug in any way.

## Description

- a Water Reservoir Lid
- b Water Reservoir
- c Carafe
- d Heating Plate / Base
- e Water Level Indicator
- f Swing Out Filter Basket
- g Filter Basket Soft Release Button
- h Programmable Clock
- i Cord Storage
- j Duo Filter Water Filtration
- k Water Filtration Holder
- l Water Filtration Change Indicator

### Models with Timer

- m On/Off
- n Hours and Minutes Setting Button
- o Programming Button
- p 1-3 Cup Flavor Setting Button
- q Display

## Description of Features

- Water Reservoir : Lid flips back for easy access.
- Carafe : Both thermal and glass carafes are designed with drip free pour spout and ergonomic handle for easy pouring.
- Heating Plate : On glass models with timer the heating plate can be programmed to stay on from 1 - 5 hours. The default setting is 2 hours.
- Swing Out Filter Basket : Use #4 paper filters or a permanent filter.
- Filter Basket Soft Release Button : Opens the filter holder to insert filter and add coffee.
- 1-3 Cup Flavor Setting : For brewing smaller quantities while fully extracting the coffee flavor.
- "Duo Filter" Water Filtration : Active vegetable based double acting anti-chlorine and anti-scale filter. The anti-chlorine action of the filter brings out the most delicate flavors of the coffee. The anti-scale action allows for longer periods between descaling.

**Note:** There is a rotary indicator on the top of the water filter holder. This indicates when the "Duo Filter" should be changed. Place the index mark next to the month the filter should be changed, referring to the chart below.

**Example:** If you replace the "Duo Filter" in January (1) you should set the indicator to March (3) or May (5), depending on the hardness of your local water supply: position the number 3 or 5 opposite the index mark.

| Water type | Uses      | Replace Duo filter every: |
|------------|-----------|---------------------------|
| Soft water | about 120 | 4 months                  |
| Hard water | about 80  | 2 months                  |

**Important:**

- The “Duo Filter” must only be used with water.
- The coffee machine still functions if the water filter is not in place.
- If the coffee machine has not been used for more than one month, rinse the “Duo filter” under running water.
- It is recommended not to leave the “Duo Filter” in place for more than 5 months.
- Your appliance is designed for use with the carafe type (glass or thermal) it was purchased with. Do not use thermal carafes on coffeemakers purchased with a glass carafe and vice versa.

**Before First Use**

- Run the coffee machine through one cycle with water only. Do not run with coffee or the “Duo Filter”(j).
- Remove the “Duo Filter” from its plastic covering. Rinse it under tap water for 1 minute.
- Lift the water reservoir lid (a) and remove the water filtration holder (k).
- Rotate the lower part of the holder and insert the “Duo Filter” into its housing.
- Replace the water filtration holder. The coffee machine is ready to use.

**Making the Perfect Cup of Coffee**

Making the perfect cup of coffee is something different for everyone. It is an art and a science, that is not only effected by the coffee that is used, but also the equipment. The water, the water temperature, the time the water is in contact with the coffee, the grind, the type of filter, all play an important role in determining the flavor. Fine tuning these aspects is the art of making the ultimate cup of coffee.

The four main principles :

**1. The Water**

It is important to use fresh water that you like. Since coffee is 98% water the taste of the water will come through in the coffee. The Duo Filter system removes chlorine taste, but the better the water you start with the better the flavor of the coffee.

**2. The Coffee**

Chose premium fresh whole beans suited to your taste. There are two principale species of coffee: Arabica and Robusta. Arabica beans are the choice beans with more flavor and less caffeine. Robusta beans have more caffeine and are more « robust » and are usually used in blends. The origin of the beans and the roast will determine the flavor. Roasts vary from light to very dark. Light roasts have a smooth, delicate aromatic taste, medium to medium dark roasts are slightly stronger, with a full-bodied balanced taste, and dark roasts are bold with smoky undertones.

**3. The Grind**

Use the proper grind finesse and grind just prior to brewing. The variation in the grind depends on the type of filter you use. We prefer paper filters because they allow you to use a finer grind, thus allowing a full extraction and more contact time with the water. Permanent filters require a slightly coarser grind therefore the extraction rate is reduced. A general rule of thumb for grinding is the longer the brew process the coarser the grind.

#### 4. The Proportion

We recommend that you use 1 rounded Tbsp. of ground coffee per cup and modify the quantity to suit your taste.

### Making Coffee

- Follow the illustrations from 1 to 8.

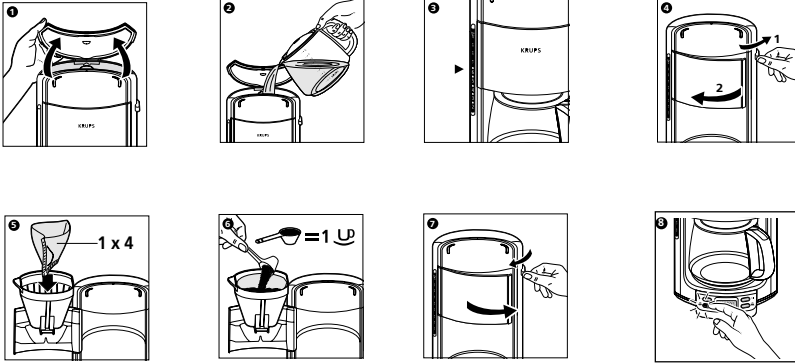

- Use only cold water and a #4 filter paper or a permanent filter.
- The coffee maker is fitted with a drip-stop device, allowing you to serve coffee before the water has finished running through. Replace the carafe quickly to avoid overflow.
- Do not exceed the maximum capacity of the water reservoir as shown by the water level indicator (e).
- Place the ground coffee into the paper filter or directly into a permanent filter. After use, discard the grounds, and rinse the filter basket under running water.
- It is normal for a small amount of steam to escape during the brewing cycle.

#### **For models with thermal carafe:**

- To ensure maximum heat retention, rinse the thermal carafe with HOT water before use, and close the lid by turning clockwise.



To serve coffee depress the trigger (9).

### Features of Programmable Timer Models

If your model has a programmable clock/timer the following features are included:

- . Auto On - Allows you to set the daily start time of the brew cycle.
- . Auto Off - Allows you to set the length of time the coffee machine will stay on. It can be set from 1 to 5 hours for units with glass carafes and is set to 20 minutes for units with thermal carafes.
- . Audible Signal - Beeps when the coffee is done brewing. This can be turned off or on.
- . 1 - 3 Cup Flavor Setting : To extract the full flavor or the grinds from smaller quantities. **(10)**

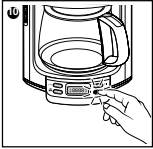

**Exercise caution with hot water and steam.**

- . Electronic Limescale Detection - Indicates when the coffee machine needs to be descaled.
- . Empty Water Reservoir - Indicates when the water reservoir has not been filled and automatically shuts off the coffee machine.

## Programming Your Coffee Machine

- Plug in your appliance: the display will light up briefly in blue, blink "8888" and then remain fixed.
- Press the **O/I** button if you wish to make coffee without using the programmable mode.
- The display will light up in blue and alternately show "ON" and the current time.
- Press the **O/I** button to shut off the coffee machine. The display will no longer be lit.

### Setting and Adjusting the Clock

- The machine must be "off".
- Press and hold the **prog** button (o) for 3 seconds: the hours will blink "88 \_ \_".
- Adjust the hours in steps by pressing the **h/min** button (n).
- Press the **prog** button : the minutes will blink "XX 88".
- Adjust the minutes in steps by pressing the **h/min** button.
- Confirm the setting by pressing the **prog** button.

### Setting Auto On

This programs the coffee machine to start automatically at the set time each day.

- Press the **prog** button (o) briefly : the display will blink "prog" for about 1 second, followed by "8888".
- Press the **prog** button briefly: the hours will blink "88 \_ \_".
- Adjust the hours in steps by pressing the **h/min** button (n).
- Press the **prog** button briefly: the minutes will blink "XX 88".
- Adjust the minutes in steps by pressing the **h/min** button .
- Confirm the setting by pressing the **prog** button briefly:
- The display (q) will show the time and a "☺".
- Press the **h/min** button to cancel the programming.

### Changing the Programming

- Press the **prog** button (o) briefly : the current clock setting will blink.
- Now proceed as above.

### Setting Auto Off (units with timer only)

On models with a glass carafe, the auto off can be set to shut the coffee machine off from 1 - 5 hours after the brew cycle is complete. The factory setting is 2 hours. On models with a thermal carafe, the coffee machine shuts off after 20 minutes.

**Note : On models without a timer the coffee machine must be turned off manually. It will not automatically shut off.**

- Press the **prog** button (o), immediately followed by the **h/min** button (n).
- The display will show the time setting.
- Press the **h/min** button in steps to set the auto off time.
- Press the **prog** button to confirm the setting.

### Setting Audible signal

This function gives an audible signal when the coffee is ready. The factory setting is "On".

- The display (q) will show "🔔" with the current time.
- To turn off the audible signal :
  - Press **prog** button then the **1 - 3 cup** button (p).
  - The display will show "YES": indicating the audible signal is on.
  - To turn the audible signal off:
    - Press the **1-3 cup** button again.
    - The display will show "NO": the audible signal is off.
    - Press **prog** button to confirm.

### 1 - 3 Cup Flavor Setting

This setting extracts the full flavor of the coffee when making small quantities.

- Press the **1-3 cup** button (p).
- The display will show "☺" with the current time.

**Note:** this function cannot be changed once the brew cycle has started.

### Empty Water Reservoir

This feature automatically shuts off the coffee machine when the water reservoir has not been filled.

- The display will show: "🚰 = 3".
- Wait for the coffee maker to cool down (about 10 minutes) before filling the reservoir (a) with water.
- Press the **O/I** button to cancel the icon.
- Press the **O/I** button again to start your coffee machine.

### Descaling Indicator (calc sensor)

This feature warns that the coffee machine needs to be descaled.

- The display (q) will show "CALC".
- See descaling section.

## Cleaning

Turn off the coffee machine and remove the plug from the outlet. Do not clean the coffee machine when it is hot. Never immerse the coffee machine in water or put it under running water.

- Clean the body of the coffee machine with a damp cloth or sponge.
- Open the filter holder and remove the paper or permanent filter. The filter holder can be washed in warm soapy water and rinsed thoroughly, or cleaned in the upper rack of a dishwasher.
- We recommend washing carafes by hand with a mild detergent.
- Do not use scouring agents or harsh cleansers on any part of the coffee machine.

## Descaling

Descaling is necessary to keep your coffee machine running efficiently. The frequency of descaling depends on the hardness of your water and how often you use the coffee machine.

If you notice the brew cycle has slowed it is generally time to descale the machine.

See the chart below:

| Type of Water | Without Duo Filter Water Filtration | With Duo Filter Water filtration |
|---------------|-------------------------------------|----------------------------------|
| Hard          | 40 uses                             | 80 uses                          |
| Soft          | 80 uses                             | 160 uses                         |

- Before descaling, remove the filter holder (k).
- You may use either the Krups descaling solution diluted in 8 ounces of water or 8 ounces of white vinegar.
- Pour the solution or vinegar into water reservoir (b) and start the coffee machine (without coffee).
- Allow half the liquid to run into the carafe, then switch off and let stand for 1 hour.
- Restart the coffee machine to complete the cycle.
- Rinse the coffee machine by running it through 2 full cycles with water only.
- On the timer models if the display continues to read "CALC" repeat the process again.

## Cord storage

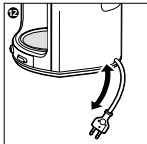

Unused cord can be stored under the coffee maker. **(12)**

## Accessories

Accessories can be purchased at many retail stores, or by calling your respective countries consumer service department.

- Permanent filter: F049
- 12-cup glass carafe, black: F15B0G
- 12-cup glass carafe, white: F15B0H
- 10-cup thermal carafe , black: F15B0J
- 10-cup thermal carafe , white: F15B0K
- 10-cup stainless steel thermal carafe, black: F15B0P
- 10-cup stainless steel thermal carafe, white: F15B0Q
- Duo Filter water filtration cartridges - pack of 2 : F472
- Krups descaling solution : F054

## Troubleshooting

| PROBLEM  | SOLUTION   |
|--|--|
| Coffee machine does not turn on.                             | Check to ensure the appliance is plugged into a working outlet, and the appliance is in the «ON» position.   |
| Appliance appears to be leaking.                             | Make sure that the water tank has not been filled beyond the max. fill level.  |
| The thermal carafe does not keep the coffee hot long enough. | For best results we recommend that you pre-heat your therm with HOT water just prior to brewing. This will ensure the hottest coffee for the longest time.   |
| Takes a long time to brew.                                   | It may be time to descale your coffee maker. On timer models you should see the words «CALC» in the display. On non-timer models you should descale every 40 to 80 uses depending on the hardness of your water. |

If your appliance still does not work, please call your respective countries consumer service department.

## **LIMITED WARRANTY**

This Krups product is warranted for 1 year from the date of purchase against defects in material and workmanship. During this period, the Krups product that, upon inspection by Krups, is proved defective, will be repaired or replaced, at Krups' option, without charge to the customer. If a replacement product is sent, it will carry the remaining warranty of the original product. This warranty does not apply to any defect arising from a buyer's or user's misuse of the product, negligence, failure to follow Krups' instructions, use on current or voltage other than that stamped on the product, wear and tear, alteration or repair not authorized by Krups, or use for commercial purposes.

**THE WARRANTIES SET FORTH HEREIN ARE EXCLUSIVE AND NO OTHER WARRANTIES, EXPRESS OR IMPLIED, INCLUDING BUT NOT LIMITED TO ANY WARRANTY OF MERCHANTABILITY OR FITNESS FOR A PARTICULAR PURPOSE OR USE, ARE MADE BY KRUPS OR ARE AUTHORIZED TO BE MADE WITH RESPECT TO THE PRODUCT.**

Some states do not allow limitation on how long an implied warranty lasts or do not allow the exclusion of incidental or consequential damages, so the above limitations may not apply to you. This warranty gives you specific legal rights, and you may also have other rights, which vary from state to state.

If you believe your product is defective, bring the product (or send it, postage prepaid) along with proof of purchase to the nearest authorized Krups Service Center. (Please contact your respective countries customer service department, indicated below, for the address of the nearest authorized Krups Service Center.)

If you send the product, please include a letter explaining the nature of the claimed defect.

**If you have additional questions, please call our Consumer Service Department:**

**USA: 1-800-526-5377;**

**Mon – Fri 8:30 a.m. – 7:00 p.m. (EST).**

**[www.KrupsUSA.com](http://www.KrupsUSA.com)**

**Canada: 1-800-418-3325;**

**Mon – Fri 8:30 a.m. – 4:30 p.m. (EST)**

**[www.Krups.ca](http://www.Krups.ca)**

Please note hours are subject to change.

Before calling the Consumer Service Department, please have the type number of your Krups appliance available. This will assist in answer your questions. The type number is generally found on the bottom of the machine. It would be helpful if you had the appliance available at the time of your call.

General correspondence can be addressed to:

USA:

Krups

196 Boston Avenue

Medford, MA 02155

**Only letters can be accepted at this address. Shipments and packages that do not have a return authorization number will be refused.**

Canada:

Groupe SEB Canada Inc.

455 Finchdene Square

Scarborough, Ontario M1X 1B7

## **GARANTÍA LIMITADA**

Este producto de Krups está garantizado por un año desde su fecha de compra contra cualquier defecto de fabricación o en cualquiera de sus componentes. Durante este período, los productos de Krups que, siendo inspeccionados por Krups, sean probados como defectuosos, serán reparados o repuestos sin cargo alguno para el consumidor. Si la reposición es enviada por mensajería o correo, ésta deberá incluir la garantía del producto original. Esta garantía no aplica para defectos causados por negligencia, incumplimiento de las instrucciones de Krups, uso de voltaje diferente al indicado en el producto, alteraciones o reparaciones no autorizadas por Krups, o utilizado para fines comerciales.

**LA GARANTÍA QUE AQUÍ SE SEÑALA ES EXCLUSIVA Y NINGUNA OTRA GARANTÍA, EXPRESA O IMPLÍCITA, QUE SE LIMITE AL PROPÓSITO DEL PRODUCTO, ESTA AUTORIZADA POR KRUPS.**

Si cree que su producto está defectuoso, envíelo a cualquier Centro de Servicio Autorizado Krups.

Si tiene preguntas adicionales, por favor comuníquese a nuestro departamento de servicio al cliente:

**México:**

**01-800-50-545-00 Lada sin costo Lunes a Viernes 7:00 am - 4:30 pm**

**01-800-112-TFAL lada sin costo Lunes a Viernes 7:00 am - 4:30 pm**

Antes de llamar al Centro de Servicio a Clientes, por favor tenga a la mano el modelo de su aparato Krups. Usted debe tener esta información antes de llamar al Centro de Servicio a Clientes para poder ofrecerle una mejor atención y una pronta respuesta a sus dudas. El modelo es el número que se encuentra en la parte inferior del aparato.

Su correspondencia puede ser enviada a la siguiente dirección:

G.S.E.B. MEXICANA, S.A. DE C.V.

Goldsmith 38-401, Col. Polanco

11560 México, D.F.

FME1/FME2/FME4/FMF3/FMF4/FMF5

US/F/E

0827 242-A