

This Owner's Manual is provided and hosted by [Appliance Factory Parts](#).



HOOVER U6425-900 Owner's Manual

[Shop genuine replacement parts for HOOVER
U6425-900](#)



[Find Your HOOVER Vacuum Cleaner Parts - Select From 1456 Models](#)

----- Manual continues below part list -----

Available Replacement Parts for HOOVER U6425-900

HR-1028	BELT, FLAT, UPRIGHTS, 1PK
HR-1856	FILTER HOOVER
HR-1832	FILTER FOR VACUUM 2 pack
H-40201200	V BELT, W/POWER DRIVE, 1PK
K-109289	BULB
H-38434021	HANDLE RELEASE LEVER
FA-3035	ATTACHMENT CORD ASSY
H-36426034	Secondary filter retainer.
H-38421094	Adjustment knob.
H-43244005	Rear wheel
HR-2003	AGITATOR ASSY, COMPLETE
HR-5310	UPRIGHT DUST BRUSH AFTERMARKET

HOOVER Original

WINDTUNNEL WITH POWER DRIVE

Models U6425-900, U6445-900, U6446-900, U6449-900, U6451-900, U6455-900

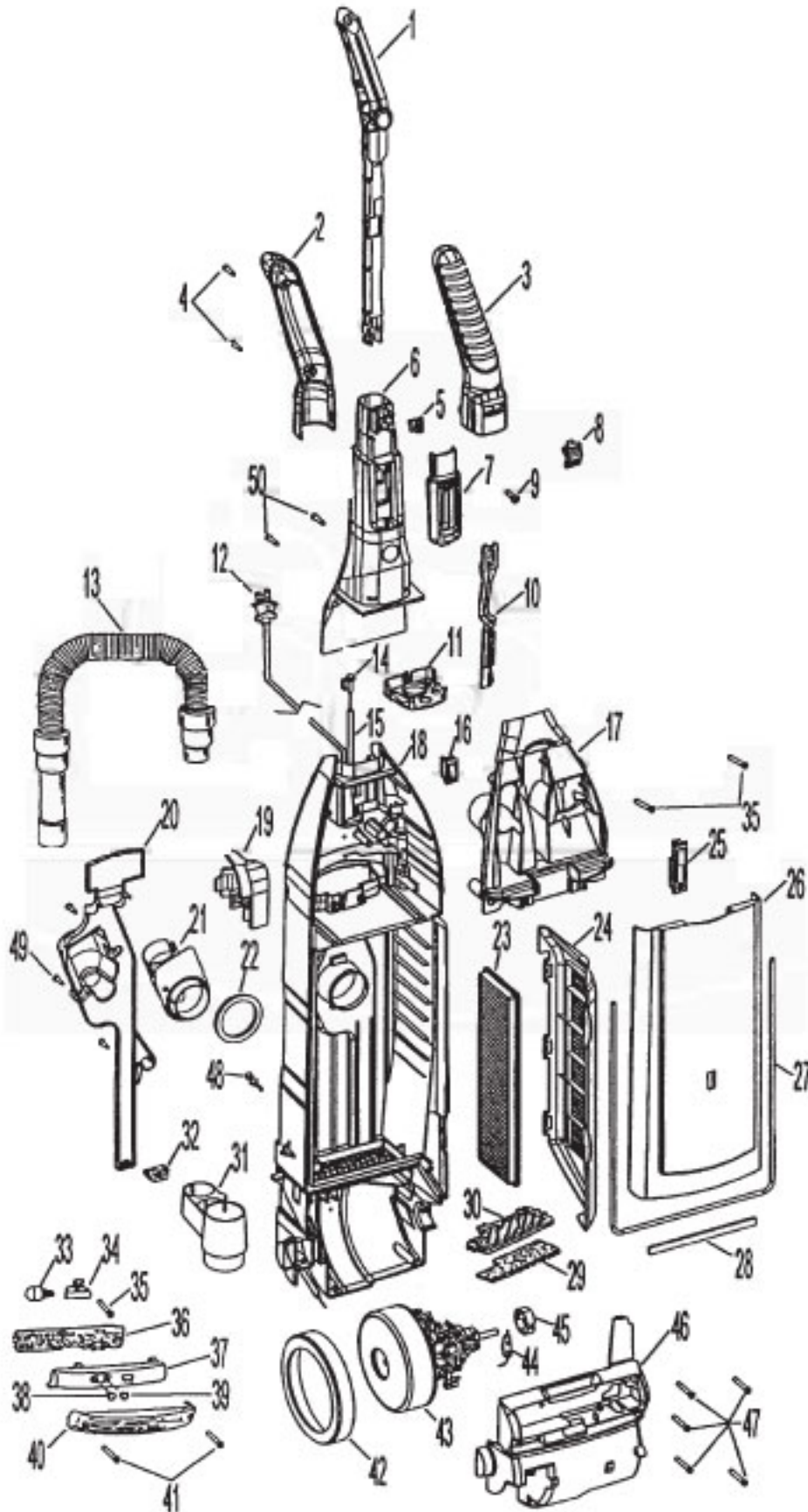

HOOVER Original

WINDTUNNEL UPRIGHT WITH POWER DRIVE

Models U6425-900, U6445-900, U-6446-900, U6449-900, U6451-900, U6455-900

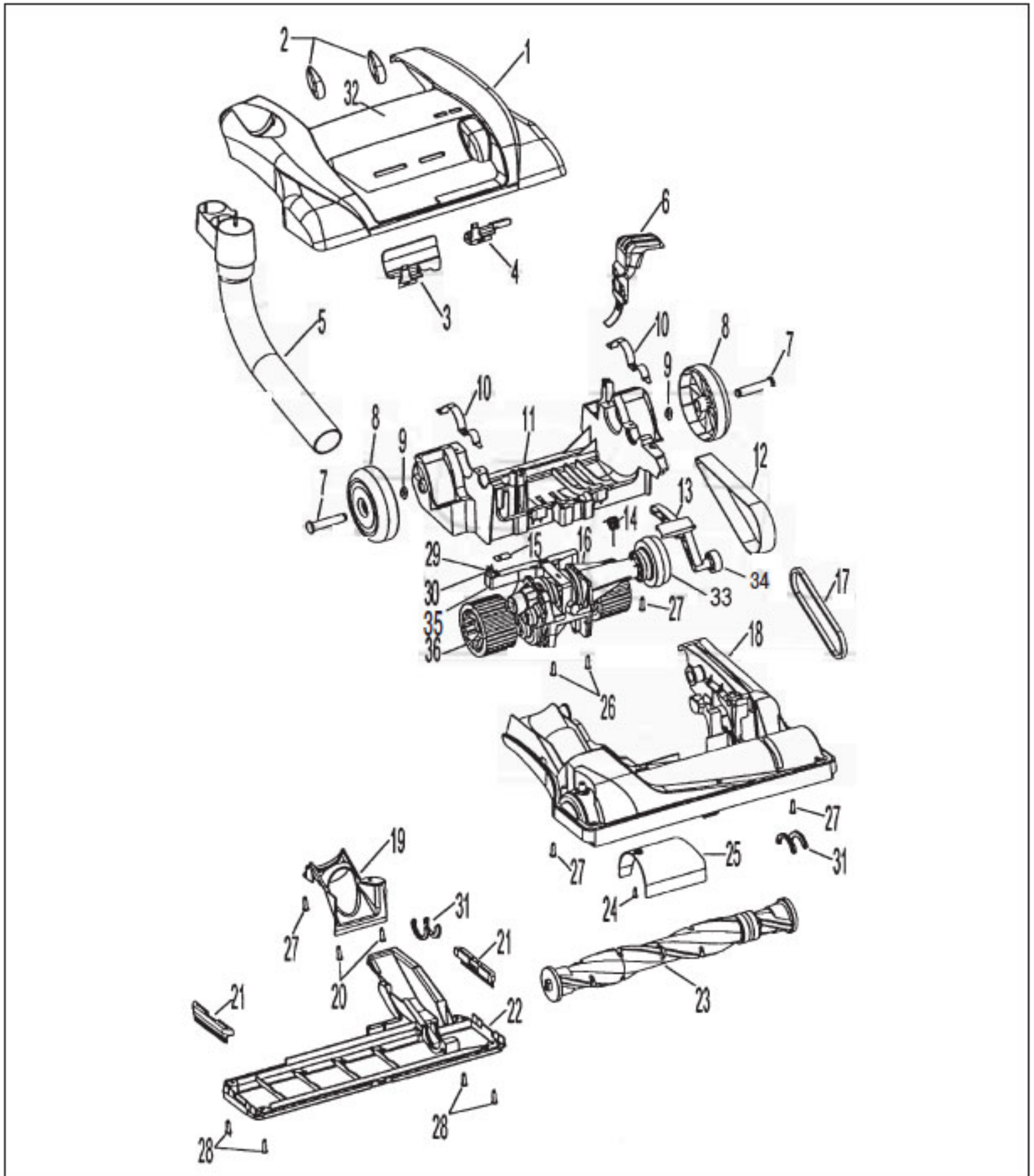

Original **HOOVER**

WINDTUNNEL UPRIGHT WITH POWER DRIVE

Models U6425-900, U6445-900, U-6446-900, U6449-900, U6451-900, U6455-

KEY	PART NO.	DESCRIPTION
1	H-37253301	Hood Ass'y - ABM - U6425-900 (Inc. items 2, 3, 4)
1	H-37253300	Hood Ass'y - ACJ - U6445-900, U6451-900 (Inc. Items 2, 3, 4)
1	H-37253302	Hood Ass'y - AG - U6455-900 (Incl. It. 2, 3, 4)
1	H-37253304	Hood Ass'y - ACM - U6449-900 (Incl. It. 2, 3, 4)
2	H-38421094	Adjustment Knob (2)
3	H-38563026	Nozzle Adjustment Cam
4	H-36143004	Idler Arm Lock
5	H-41426036	Wand / Hose Holder
6	H-38434021	Handle Release Lever
7	H-32434008	Rear Axle (2)
8	H-43244005	Rear Wheel Ass'y (2)
9	H-160017	Retaining Ring
10	H-36131096	Trunnion Cover (2)
11	H-37241150	Main Body
12	H-38528035	Flat Belt
13	H-43241004	Idler Arm Ass'y
14	H-38356015	Torsion Spring - U6425-900 and U6445-900 Early Models (see note)
14	H-38356014	Torsion Spring - U6449-900, U6451-900, U6455-900, U6425-900 and U6445-900 Late Models (see note 2)
15	H-34125004	Retainer-Control Cable
16	H-43124015	Power Drive Ass'y
17	H-38528034	V Belt - Agitator
18	H-42246136	Agitator Housing - (Incl. It. 24, 25, 31) (See Note # 3)
19	H-36172007	Hose Clamp
20	H-21479446	Screw - Hose Clamp
21	H-39511004	Litter Picker
22	H-42245029	Bottom plate (Inc. Item 31)
23	H-48414069	Agitator Ass'y Complete
24	H-21479446	Screw
25	NLA	* Duct Cover Nozzle
25	H-37243013	* Duct Cover Nozzle
26	H-21447242	Screw - Trans. to Main Body
27	H-21447228	Screw
28	H-21447121	Screw - Bottom plate
29	H-21751010	Screw - Special
30	H-36128002	Washer
31	H-38781053	Agitator Pulley Seal
32	H-52115209	Hood Label - U6425-900
32	H-51438007	Hood Label - U6445-900, U6449-900, U6451-900
32	H-51438008	Hood Label - U6455-900
33	H-38537013	Drive Pulley
	H-160031	Drive Pulley Nut
34	H-43241006	Idler Pulley With Bearing
35	H-43143046	Actuator Arm
	H-36131101	Control Cable Tube Support (Not Shown)
36	H-163340	Power Drive Wheel

Note: 1

U6425-900 early models - serial numbers 059800001001
through 059800002587

U6425-900 late models - after serial number 059800002587

U6445-900 early models - serial numbers 059800001151
through 059800002672

U6445-900 late models - after serial number 059800002672

Note 2:

When replacing an agitator housing on early model U6425-900
and U6445-900 units, also update the spring to H-38356014

Note 3:

U6425-900 early models - serial numbers thru 099800061173;
Late models - after serial number 099800061173.

U6445-900 early models - serial numbers thru 099800036517;
Late models - after serial number 099800036517.

U6449-900 early models - serial numbers thru 099800007503;
Late models - after serial number 099800007503.

U6451-900 early models - serial numbers thru 099800009807;
Late models - after serial number 099800009807.

U6455-900 early models - serial numbers thru 099800003668;
Late models - after serial number 099800003668.

* DUCT COVER NOTE

FOR UNITS MANUFACTURED BEFORE 1998 ORDER
PART NUMBER H-37243013 DUCT. FOR UNITS
MANUFACTURED AFTER 1998 ORDER PART
NUMBER H-42246136 NOZZLE HOUSING MUST
BE REPLACED, NEW DUCT COVER IS INCLUDED.