



LG

REFRIGERATOR

SERVICE MANUAL

CAUTION
BEFORE SERVICING THE UNIT,
READ THE SAFETY PRECAUTIONS IN THIS MANUAL.

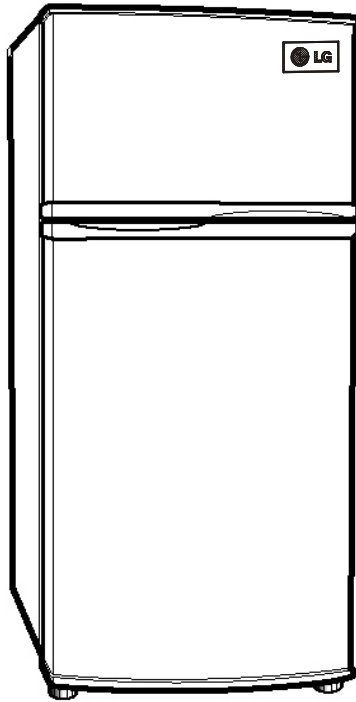

MODEL: LRTN09314SW

Contents

SAFETY PRECAUTIONS	2
SERVICE PRECAUTIONS	3
1. SPECIFICATIONS	5
2. PARTS IDENTIFICATION	6
3. CIRCUIT DIAGRAM	7
4. GRAPHIC CIRCUIT DIAGRAM	8
5. COOLING SYSTEMS	9
6. DISASSEMBLY	10
7. REVERSIBLE DOOR(*ON SOME MODELS)	13
8. ADJUSTMENTS	15
9. TROUBLESHOOTING	17
10. DESCRIPTION OF FUNCTION & CIRCUIT OF MICOM	23
11. EXPLODED VIEW & REPLACEMENT PARTS LIST	39



Safety Precautions.

Read the following instructions before servicing your refrigerator.

1. Unplug the refrigerator before servicing.
2. Visually inspect for gas leakage or short circuit.
3. If testing with the refrigerator plugged in, wear rubber gloves to avoid electric shock.
4. Do not touch frozen metal parts; your hands could freeze to the surface. This may cause frostbite.
5. Be sure that no water is dripping towards electrical or metal parts.
6. If you check the bottom part of the refrigerator while the freezer door is open, be careful standing up. You could bump your head.
7. When you tilt your refrigerator be sure to take out all metal, glass, or other loose parts.
8. When servicing the evaporator, wear cotton gloves to prevent cutting by any of the evaporator fins.

Service Precautions

Refrigerant Recharging

Test the compressor's operation before recharging the refrigerant; this is very important to detect failures and to ensure the proper motor running, and to identify failures immediately. If failure has been detected, clean the system from any other possible R-134a residues by breaking the final part of the compressor's service pipe at it's thinnest part as shown in Fig. #1. Replace the filter and any other part that could be deteriorated. Unweld and pull out the service pipe, then place a new pipe extension with a Hansen male connector and solder the new pipe. See Fig. #2

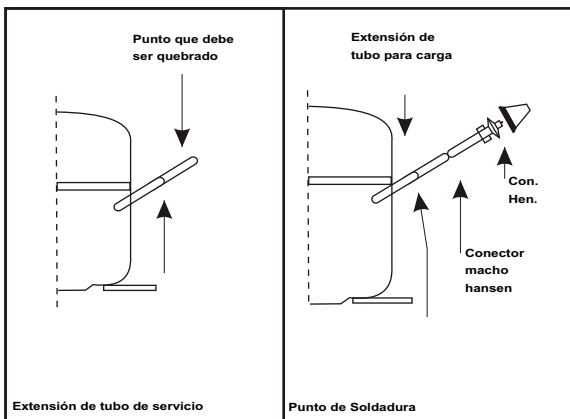

Fig. # 1

Fig. # 2

It is necessary to open the valve when soldering to allow the gases to escape without forcing the molten solder out of the joint. The extension with the male Hansen connector should be connected to a female type connector to the vacuum pump's pipe. See Fig. #3

System air evacuation starts as soon as the pump begins to run. The system must be kept under vacuum until the low pressure gauge shows

0 (absolute or -1 atm, -760 mm Hg.) It is not recommended to run the vacuum pump for more than 30 minutes. See

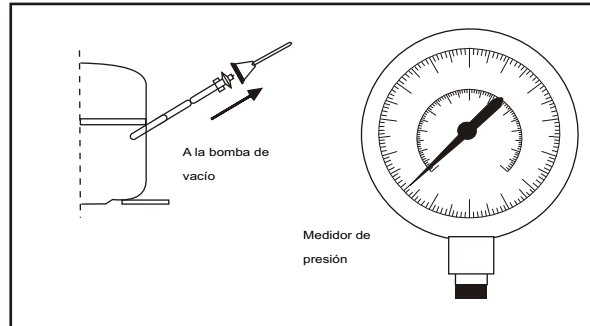

Fig.#3

Figure 3.

In case there is a large leak and the vacuum operation must stop, you must add a small amount of refrigerant to the system and check with an electronic leak detector. If a soldering failure is detected, open the valve before soldering to equalize the pressure and keep solder from being blown out of the joint or sucked into the piping.

As soon as the repair is completed, charge the correct amount of refrigerant into the system. Remember that each system requires a specific amount of refrigerant with a tolerance of ± 5 grams. See Figure 4.

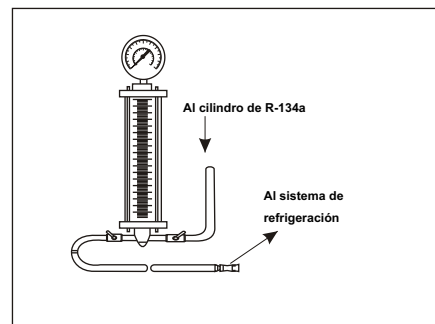

Fig. # 4

Before performing this operation (if the vacuum pump and charging cylinder are still attached to the system) be sure the valve between the pump and the cylinder is closed to

keep refrigerant out of the system.
See Figure 5.

For gas charging, check the graduated scale on the cylinder to see the amount of refrigerant that it contains and the amount that will be pumped into the system. For example, if you have 750 grams of refrigerant in the cylinder and we have to pump 165 grams to the system, this amount will be reached when the indicator reaches 585 grams; remember that the indicator shows a lower level of meniscus.

Do this after choosing the scale corresponding to the gas pressure indicated on the pressure indicator located on the upper part of the column. To let R-134a flow into the system, open the valve at the recharging cylinder's base. The total amount of refrigerant should not be

installed in one session, as it could block the compressor. Install 20~30 grams at a time and close the valve. The compressor will run and the pressure will drop. Then open the valve and install other 20~30 grams of refrigerant. Repeat this procedure until the entire amount has been added to the system. Under operating conditions, the system pressure should stabilize between 0.3 and 0.6 atm.

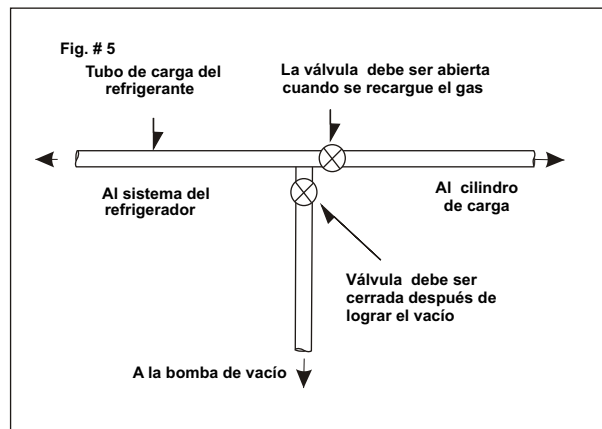
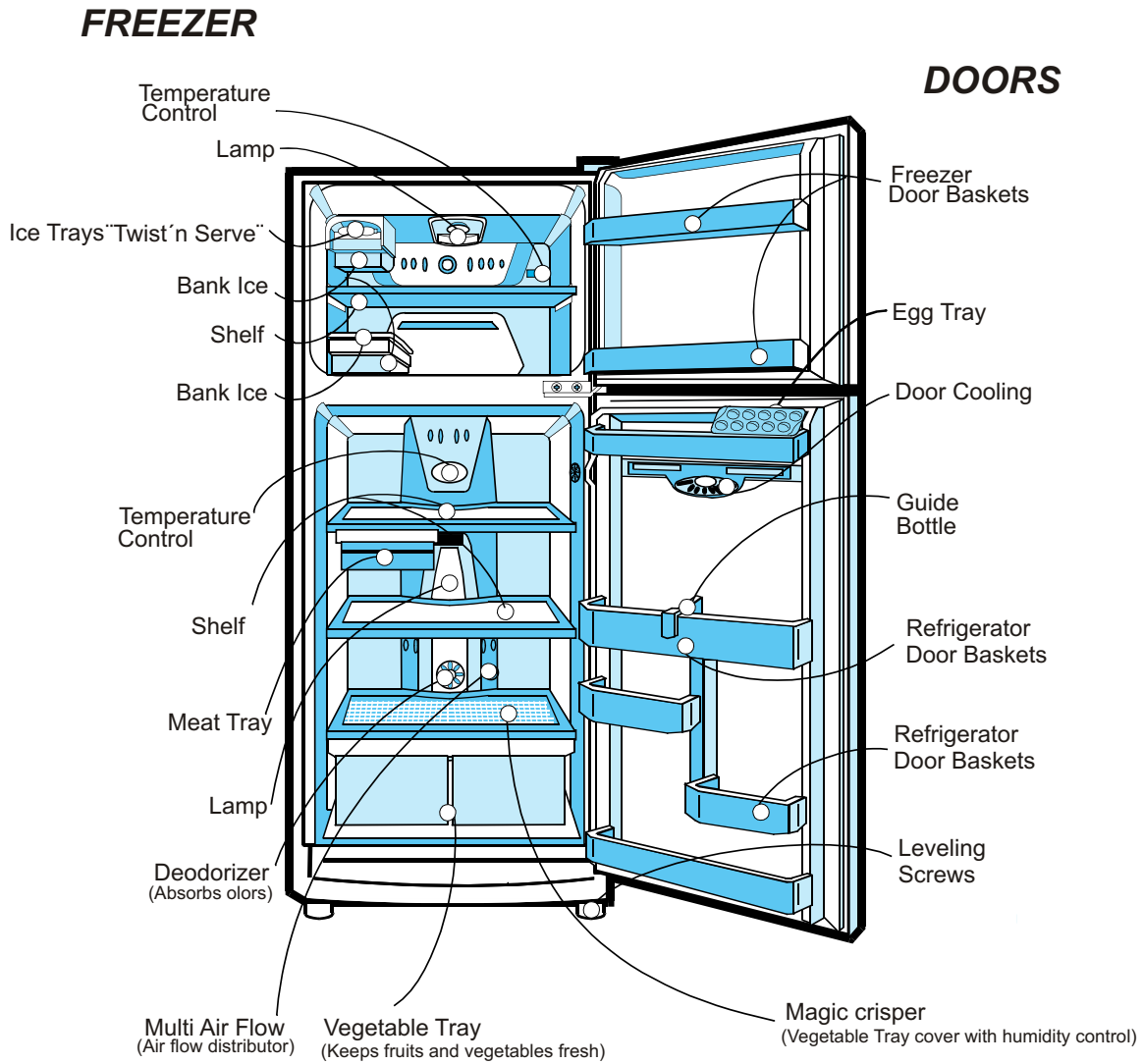

Fig. # 5

1. Specifications

MODELS		LRTN09314SW
SPECIFICATIONS		
GENERAL FEATURES	CAPACITY litros(F/R/T)	61/180*241
	DIMENSIONS in(W*H*D)	21.45*64.17*24.21
	WEIGHT	121.25Lb
	HANDLE TYPE	HORIZONTAL
	REVERSIBLE DOOR	NO
	DOOR FINISH	PCM
	REFRIGERANT	R134a
FREEZER	ICE TRAY	NORMAL
	SHELF	PLASTIC(1)
	BASKET DOOR	PLASTICO(2)
	LAMP	NO
REFRIGERATOR	TRAY MEAT	YES
	SHELF	PLASTICO(2)
	MAGIC CRISPER	YES
	LAMP	YES(1) 20W/AZUL
	GUIDE BOTTLE	NO
	DOOR COOLING	NO
	TRAY VEGETABLE	YES(1)
	BASKET DOOR	4 FULL

2. PARTS IDENTIFICATION



Note: Some components shown on this diagram, could not be included on your refrigerator; Because they are variable depending on the characteristics of each model.

3. Circuit Diagram

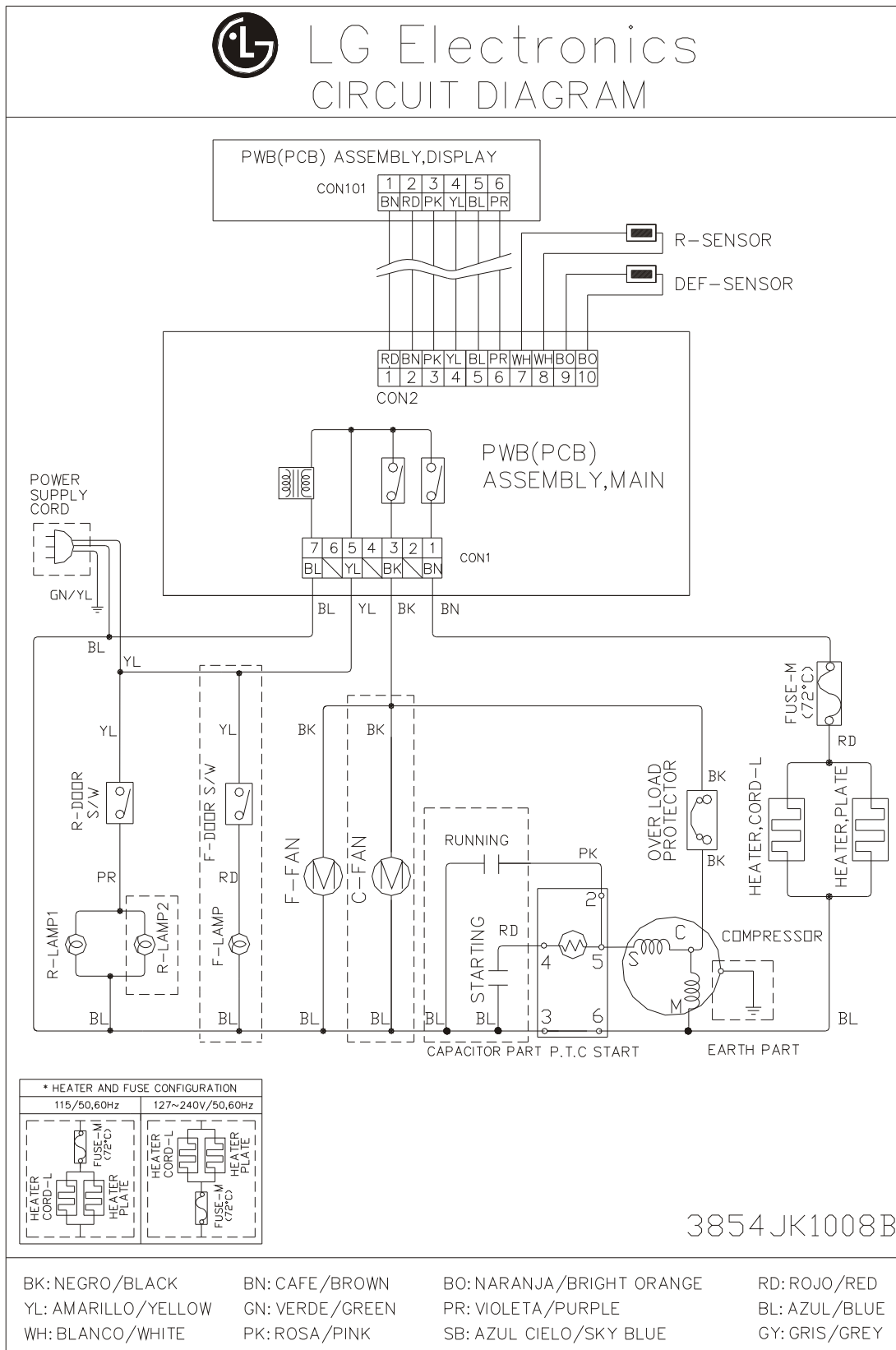

4. Graphic Circuit Diagram

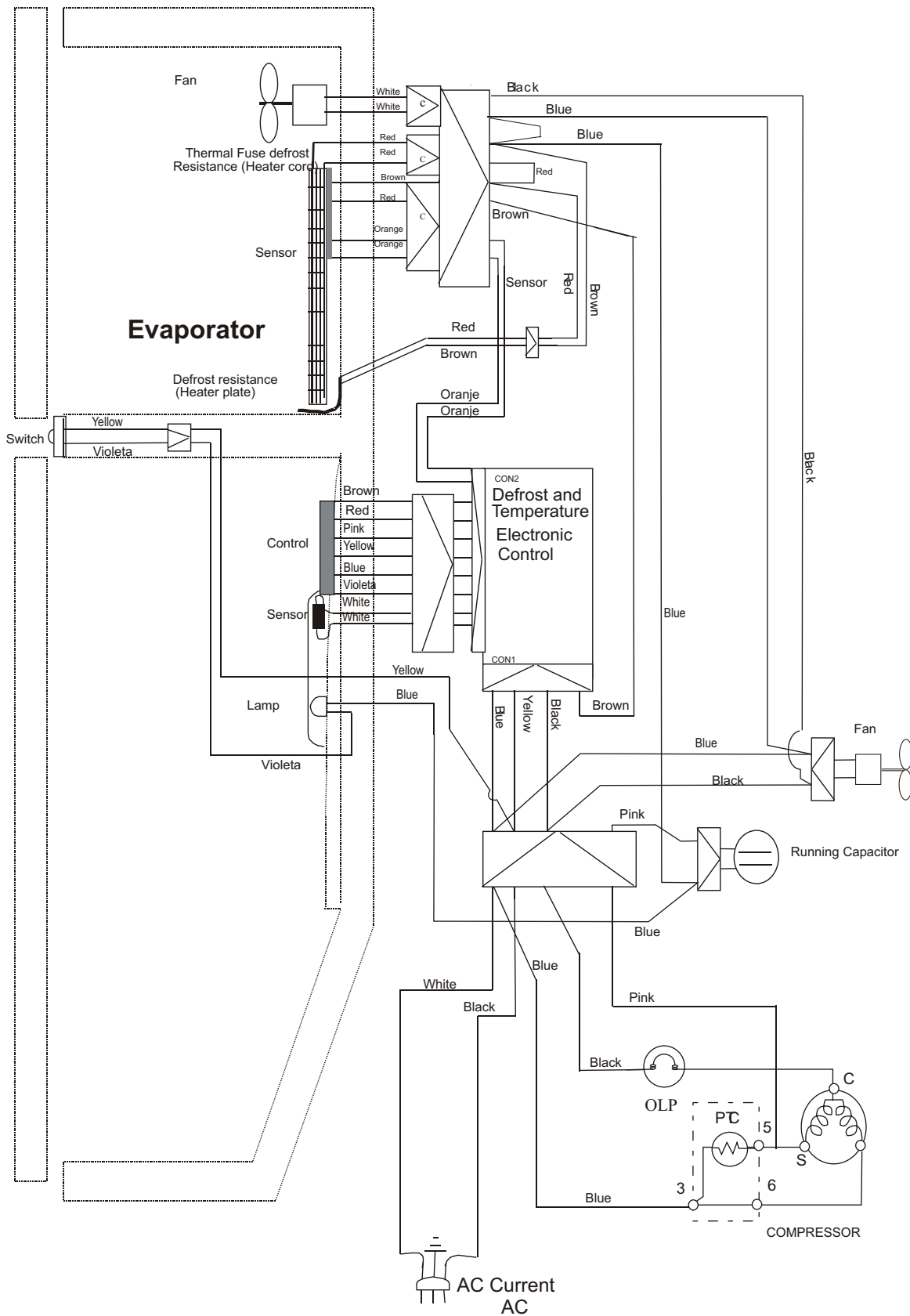

5. Cooling Systems

Direct System

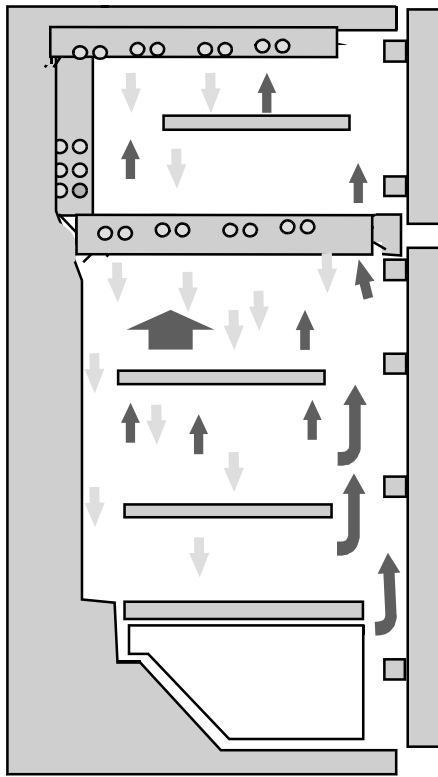

Indirect System

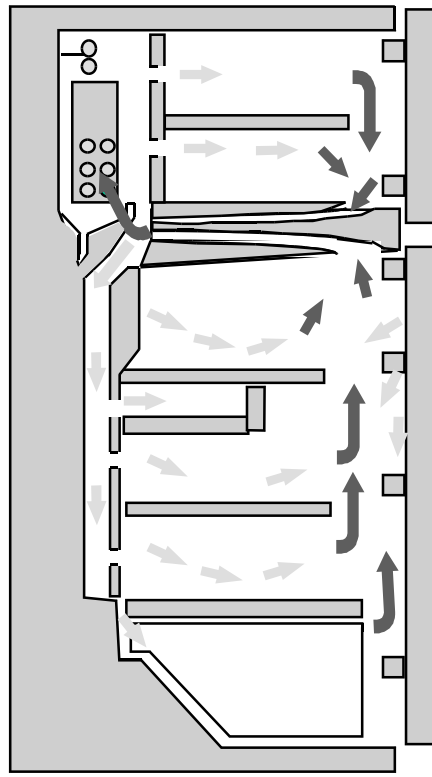

→ Cold Air

→ Warm Air

Important: Check that the air ducts are not obstructed for a better cooling performance.

Temperature variation during defrosting time, depending upon the cooling system.

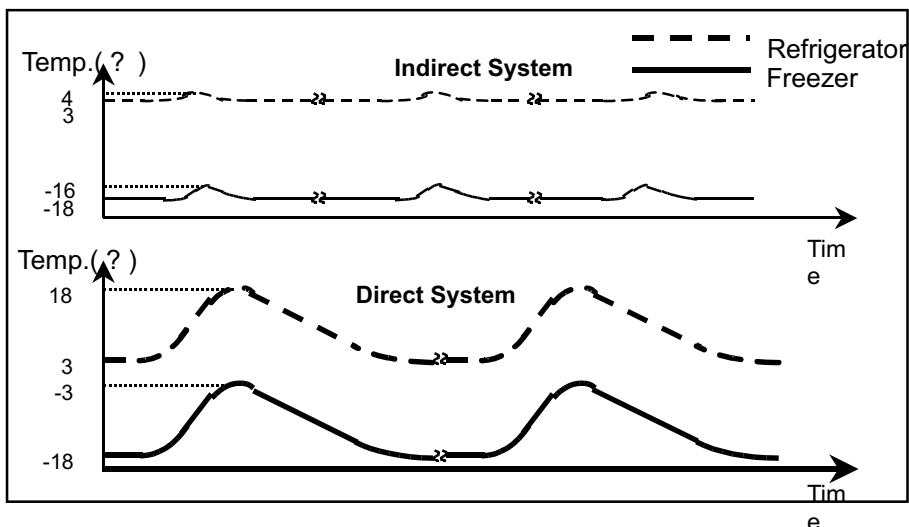

6. DISASSEMBLY

Doors

● Freezer Door

1. Remove hinge cover by pulling it upwards.
2. Loosen the hexagonal bolts that hold the upper hinge in place. See Figure 1.
3. Remove door. See Figure 2.



Figure 1



Figure 2

4. Pull gasket to remove it. See Figures 3 and 4.



Figure 3



Figure 4

● Refrigerator Door.

1. Loosen the hexagonal bolts that hold the central hinge in place. See Figure 5.
2. Remove refrigerator door. See Figure 6.
3. Pull out the gasket to remove it from the door. See Figure 4 from Freezer door.

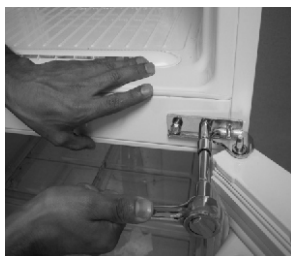

Figure 5



Figure 6

Door Switch

1. Pull out the door switch out using a flat head screwdriver. See Figure 7

2. Disconnect all switch's cables. See Figure 8



Figure 7



Figure 8

Control Circuit (Display PWB)

1. Remove the lamp cover by inserting a screwdriver in the lower side's holes. See Figure 9.
2. Loosen and remove the 2 screws. See Figure 10.

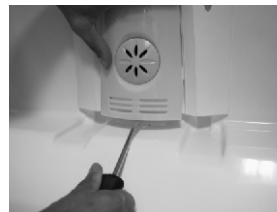

Figure 9



Figure 10

3. Pull out the Control Box. See Figure 11.
4. Disconnect the connector from the cable terminal. See Figure 12.
5. Remove the EPS Multi air duct (insulation) from the control box.
6. Detach the electronic control (Display, PWB). See Figure 13.



Figure 11



Figure 12



Figure 13

Fan and Fan Motor.

1. Remove freezer shelf.
3. Remove the ice bin assembly by pulling it to the right side, until it snaps out.
4. Remove Grill Fan screw cover. See Figure 14.
5. Loosen the screw. See Figure 15.
6. Pull out the fan cover. Figure 16.



Figure 14



Figure 15

6. Unplug the connector.
7. Remove the fan holder shroud. Figure 17.
8. Remove fan and loosen both screws that hold the bracket.
9. Remove the motor bracket and the rubber parts. Pull out the fan motor. See Figure 17.



Figure 16



Figure 17

Defrost Control Assembly

1. The defrost control assembly consists of one thermistor and a fuse that melts with heat.
2. The thermistor's function is to sense the compartment's temperature and automatically stop the defrost. The thermistor is located beside of the evaporator bracket.
3. The melting fuse is a safety device to prevent an overheating of the defrosting resistance when it operates.
4. The fuse melts at 162° F and the resistance heater stops.
5. To replace this components, please follow the steps mentioned at Figure 18.



1. Figure 18. Unplug the connector plugged to the defrost control assembly and replace it if necessary.

Lamp.

Refrigerator Compartment Lamp

1. Remove the lamp cover with a screwdriver or a similar tool. See Figure 19.
2. Remove the lamp by unscrewing it counterclockwise and replace it with the same specifications V (125 ,15W). Part Number 6912JB2002G.



Figure 19

Refrigerator Control Box.

Remove the lamp cover as mentioned before.

1. Loosen the screws.
2. Remove the entire control box.
See Figure 20.
3. Disconnect the control box connector. See Figure 21.



Figure 20



Figure 21

7. Reversible Door (*On some models)

PRECAUTION

1. Before reversing the doors, remove all foods and accesories, like shelves or trays, which are not attached to the doors.
2. Use a Philips screwdriver, bolt driver, torque wrench, or spanner to tighten and loosen the bolt.
3. Be careful not to drop the refrigerator or door when assembling or disassembling lower hinge or the Adjustable Screw Assembly.
4. Don't lay the refrigerator down to work on it. It will cause malfunction.
5. The doors may be reversed to provide left or right opening, depending upon the customer's preference.



HOW TO REPLACE THE DOOR OPENING LEFT TO RIGHT (when converting from left-opening to right opening)

1 Remove the cap and upper hinge.

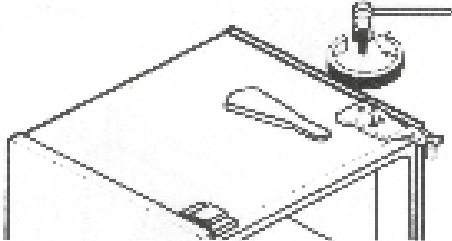

2 Remove the freezer door.

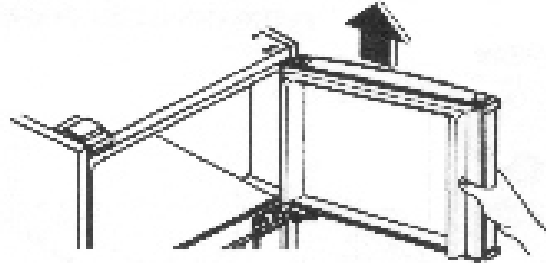

3 Remove the center hinge and the refrigerator door.

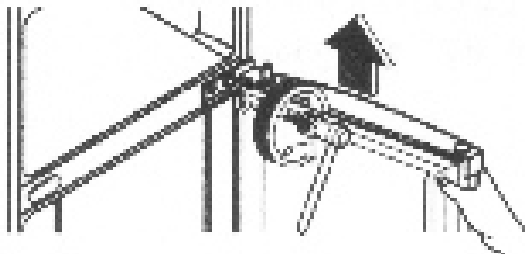

4 Remove the lower hinge.

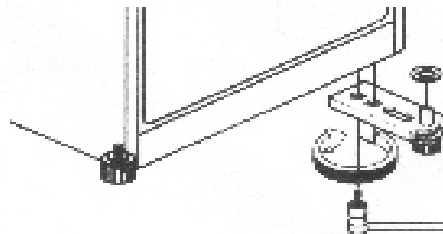

5 Reverse the position of the adjustable screw assembly.

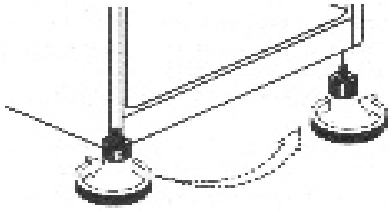

6 Assemble the lower hinge on the right side.

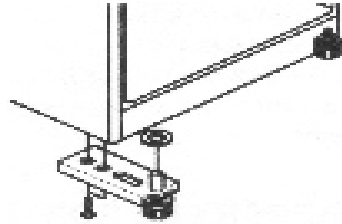

7 Move the bracket to the opposite side and assemble the refrigerator door.

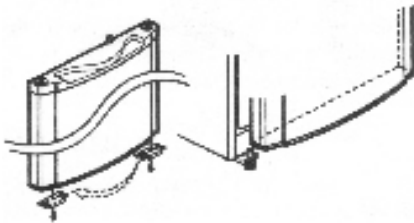

8 Move the cap to the opposite side and assemble the center hinge.

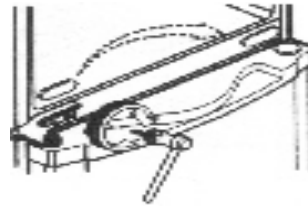

9 Assemble the freezer door stopper on the right side.

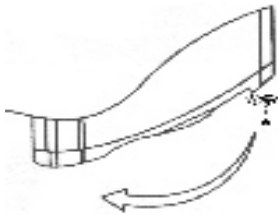

10 Assemble the freezer door.

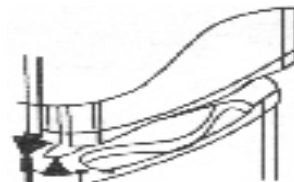

11 Move the upper cap hinge to the opposite side.

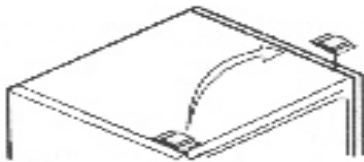

12 Assemble the upper hinge and the cap.

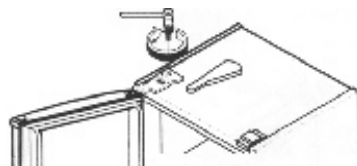

8. Adjustments

1- COMPRESSOR

1-1 Function

The compressor sucks low pressure evaporated gas from the evaporator and compresses it into high temperature/high pressure gas and sends it to the condenser.

1-2 Composition

The compressor includes the compressing system, a motor, and an enclosure. The PTC (thermistor) and OLP (Overload Protection Device) are attached to its exterior. Handle and repair the compressor with care. It includes parts manufactured to 1 micron tolerance, and is hermetically sealed to exclude dust or humidity after fabrication. Dust, humidity, or flux getting into the refrigeration cycle could clog it or otherwise affect the cooling.

1-3 Use notes.

- (1) Protect your refrigerator from over currents or overloads.
- (2) Do not bump or jar the compressor. If it is bumped or forced (dropping or careless handling,) it could damage the compressor or cause noise or undesirable operation.
- (3) Use only exact replacement parts when repairing the compressor. If the terminals become corroded, it could affect operation. If the replacement parts are of incorrect values, operation and safety will be compromised.

2- PTC

2-1 PTC Composition

- (1) The PTC (Thermistor) is a semiconductive starting component that is made with $BaTiO_3$.
- (2) The higher the temperature, the higher the resistance value will be. This characteristic is used for starting the motor.

2-2 PTC Function

- (1) The PTC is attached to the hermetic compressor and its used for its starting. This household refrigerator uses a single induction motor. During normal operation, the motor starts with current flowing through both the main and the auxiliary windings. After the motor starts, current to the auxiliary winding is cut off.

2-3 PTC- Electric Diagram

According to motor starting method.

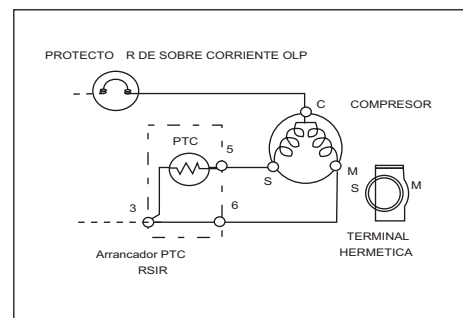

2-4 Motor restarting and PTC cooling.

- (1) To restart normal operation after a power interruption, wait 5 minutes to let the pressure equalize and the PTC to cool.
- (2) During normal operation, the PTC generates heat. If it has not had time to cool after a power interruption, the motor will not restart until the PTC cools.

2-5 PTC OLP Relation

- (3) If power is cut off during compressor operation and then restored before the PTC has cooled down, its resistance value increases. As a result, the current cannot flow to the auxiliary winding and the motor cannot start and the OLP operates due to the current overflow through the main winding.
- (3) While the OLP repeats the ON/OFF operation 3~5 times, the PTC cools and the compressor operates normally. If the OLP does not operate when the PTC is hot, the compressor motor will overheat, causing a short circuit or possibly a fire. Therefore, use a fail-safe OLP.

2-6 Note on using the starting PTC

- (1) Be careful not to cause an overvoltage or short circuit.
- (2) Do not force or bump it.
- (3) Keep the OLP dry. If water or oil gets into the OLP, the electrical insulation can degrade and fail.
- (4) Do not replace the PTC at your own convenience. Do not disassemble the PTC. If the PTC's exterior is damaged, the resistance value changes and may cause failure during the starting of the compressor's motor. Use a PTC in good condition.

3- OLP

3-1 OLP Definition

- (5) The OLP is a bimetallic, heat-sensitive switch attached to the compressor. Its function is to protect the motor in the event of overheating.
- (6) When an overvoltage flows to the motor, the bimetal reacts by heating and activating (opening) the OLP.

3-2 OLP Function

- (7) Prevents the starting to the motor winding.
- (8) Do not turn the adjustment screw during normal OLP operation. (OLP connection diagram)

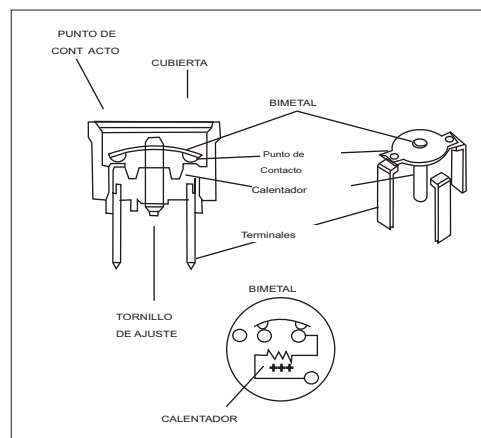

9. Troubleshooting

9-1 COMPRESSOR AND ELECTRIC COMPONENTS

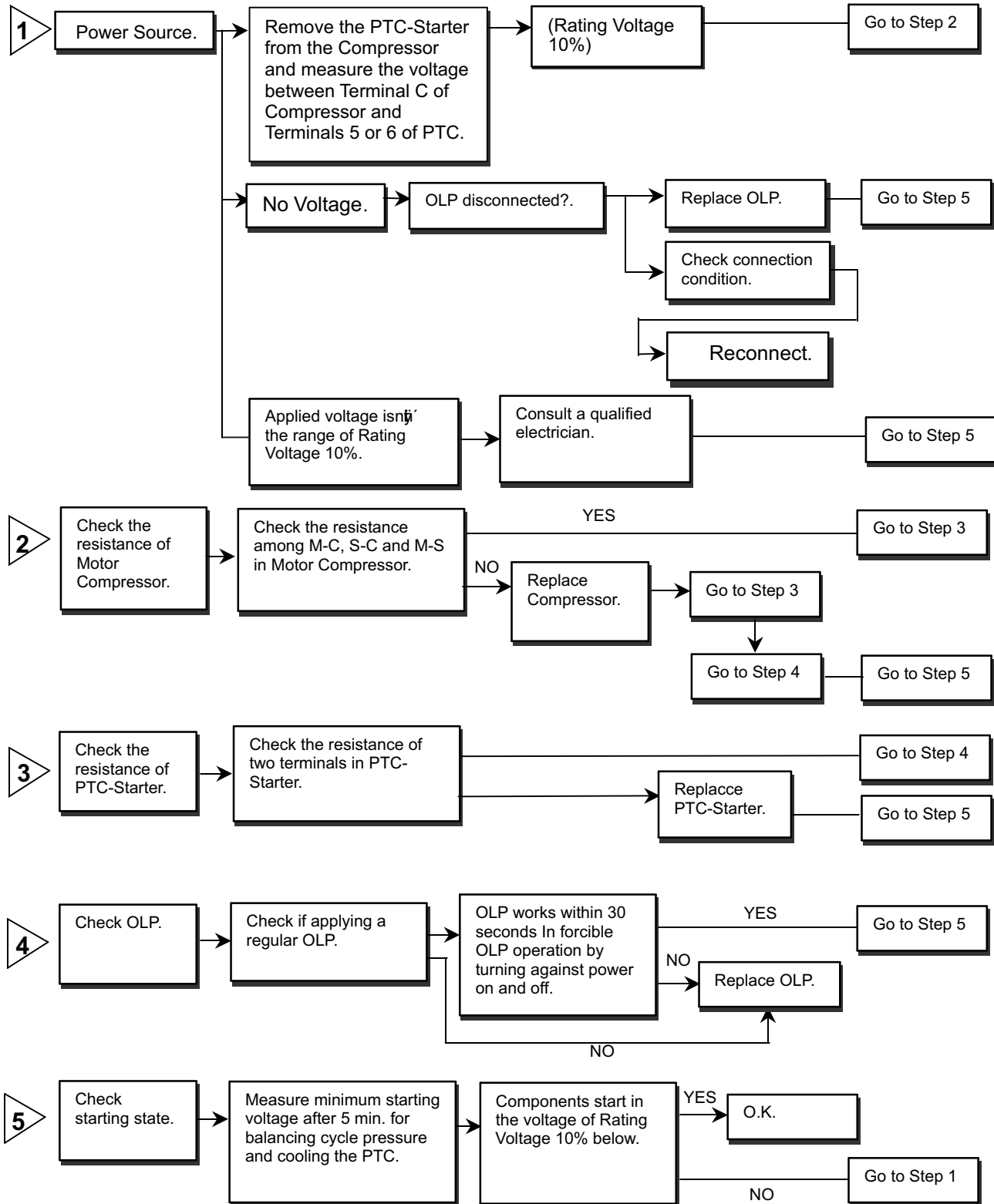

9-2 PTC AND OLP

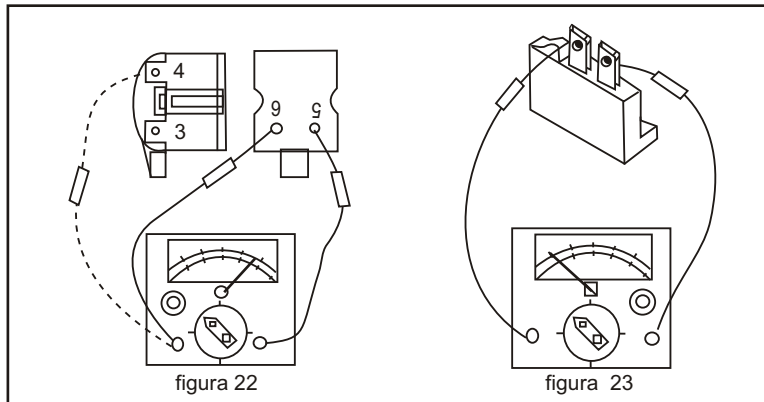
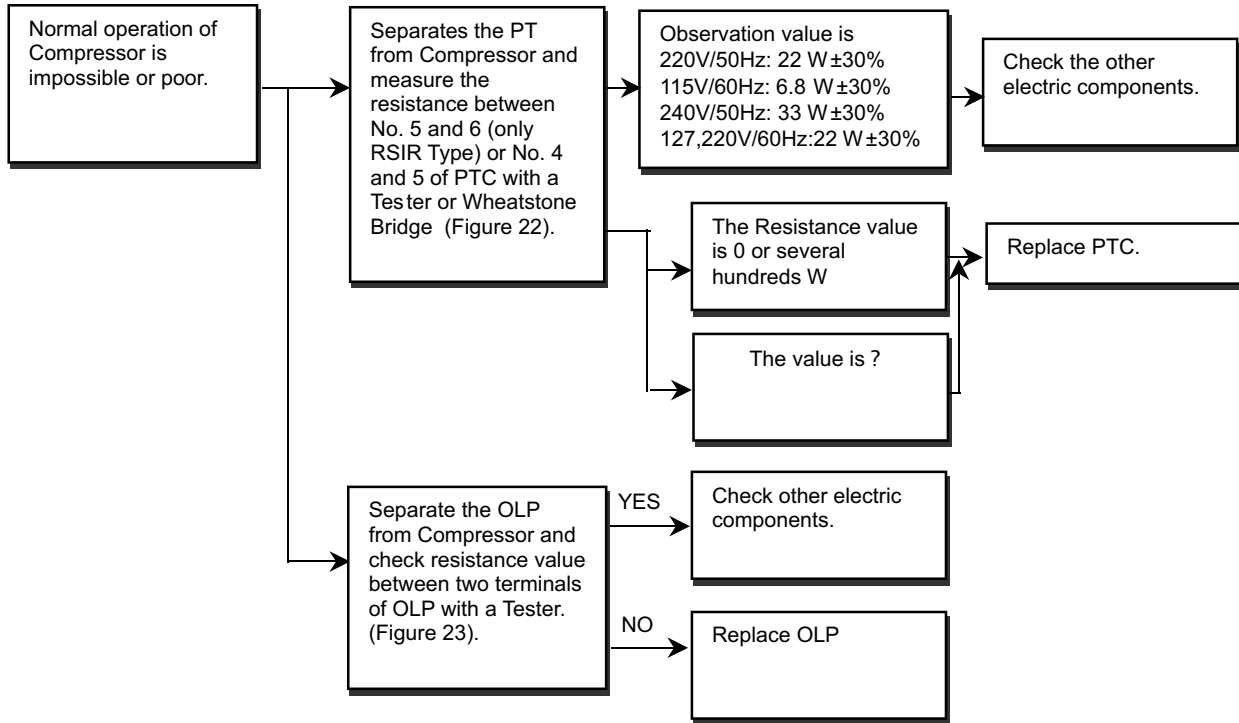

9-3 OTHER ELECTRIC COMPONENTS

• No Cooling

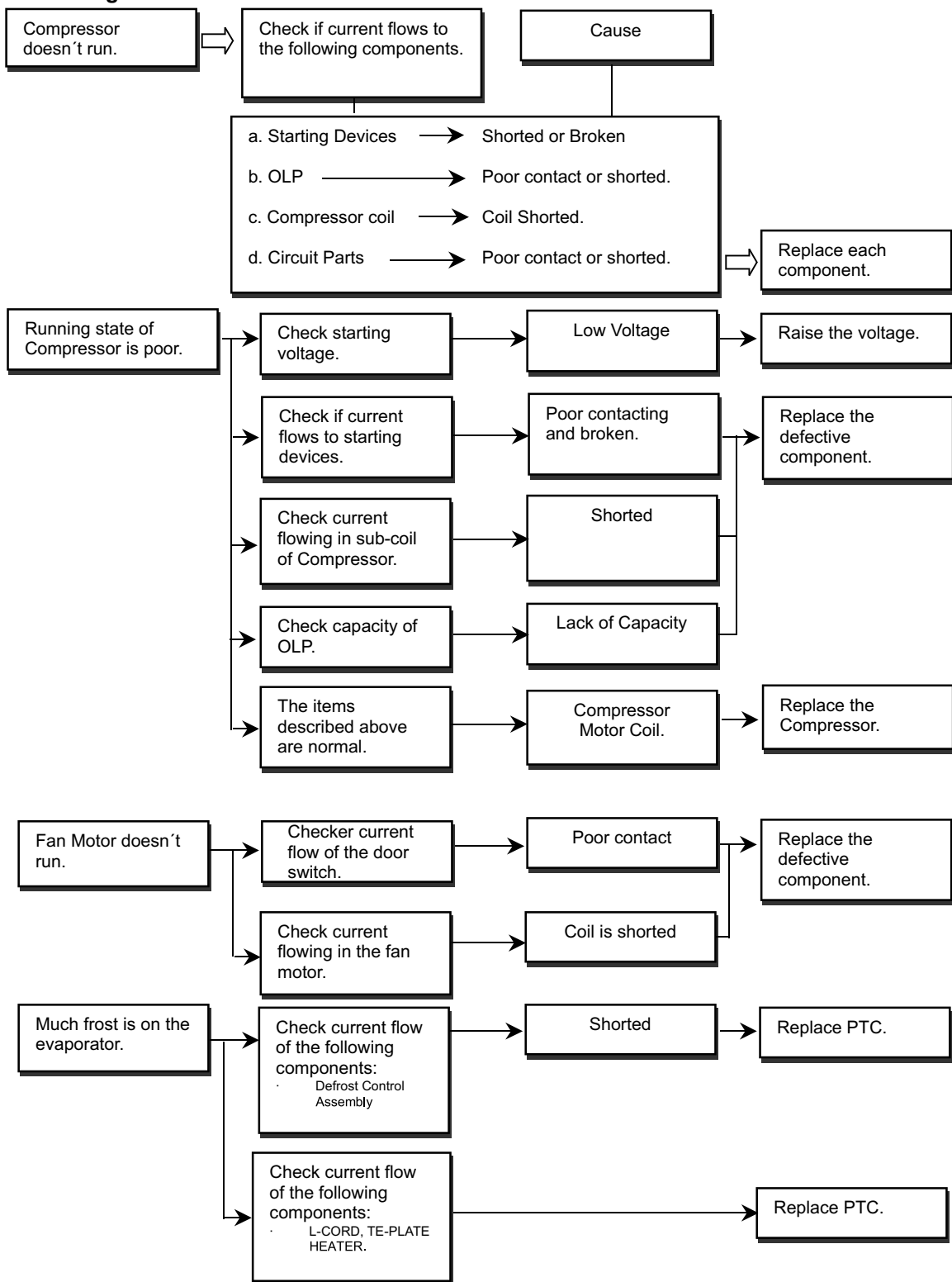

9-4 SERVICE DIAGNOSIS CHART

COMPLAINT	POINTS TO BE CHECKED	REMEDY
No Cooling	<ul style="list-style-type: none"> Is the power cord unplugged? Check if the power switch is set to OFF. Check if the fuse of power switch is shorted. Measure the voltage of power outlet. 	<ul style="list-style-type: none"> Plug it to the outlet. Set the switch to ON. Replace a regular fuse. If the voltage is low, check the wiring or call an electrician.
Poor Cooling	<ul style="list-style-type: none"> Check if the refrigerator is placed close to a wall. Check if the refrigerator is placed close to a stove, oven or in indirect sunlight. Is the ambient temperature high or the room door closed? Check if putting in hot food. Did you open the refrigerator door too often? 	<ul style="list-style-type: none"> Place the set with the space of about 10 cm. Place the set apart from these heat sources. Is the ambient temperature within spec? (above 10°C or 40°F) Put food in after it cools. Don't open the door too often and close it firmly.
Poor Freezing	<ul style="list-style-type: none"> Is the ambient temperature too low? 10°C (40°F). 	<ul style="list-style-type: none"> To make the freezer colder, set the COLD AIR CONTROL to 7 and set the R control button (PWB) to MAX.
Food in the refrigerator is frozen	<ul style="list-style-type: none"> Is food buckling the cooling air outlet? Check if the PWB is set to MAX. 	<ul style="list-style-type: none"> Place food in high temperature section (Front Part). Set the button to MID.
Moisture or ice forms in the chamber of the set.	<ul style="list-style-type: none"> Is watery food kept? Check if putting in hot food. Did you open the refrigerator door too often? 	<ul style="list-style-type: none"> Seal watery food with vinyl wrap. Put food after it cools. Don't open the door too often and close it firmly.
Moisture forms on the outside	<ul style="list-style-type: none"> Check if ambient temperature and humidity are high. Is there a gap in the door gasket? 	<ul style="list-style-type: none"> Wipe moisture with a dry cloth. This does not occur if the temperature and humidity are in the normal range. Fix the gap.
Abnormal Noise	<ul style="list-style-type: none"> Is the refrigerator positioned in a firm and even place? Is something in the way behind the refrigerator? Check if the evaporating tray cover is left off. Check if the cover of mechanical room in below and front sides is taken out. 	<ul style="list-style-type: none"> Adjust the leveling screws. Position the refrigerator properly. Remove the objects. Replace the tray. Replace the cover.
Door doesn't close well.	<ul style="list-style-type: none"> Check if the door gasket area has become dirty or contaminated. Is the refrigerator placed in a firm and even place? Is too much food put in the refrigerator? 	<ul style="list-style-type: none"> Clean the door gasket. Position the refrigerator in a firm place and adjust the leveling screws. Keep food from reaching to the door.
Ice and food smell unpleasant.	<ul style="list-style-type: none"> Check if the inside of the refrigerator becomes dirty. Did you keep fragrant foods without wrapping? It smells plastic. 	<ul style="list-style-type: none"> Clean the inside of the refrigerator. Wrap fragrant food. The new refrigerator smells of plastic, but the odor will dissipate after a couple of weeks.

- In addition to the items described above, refer to the following to solve the complaint.

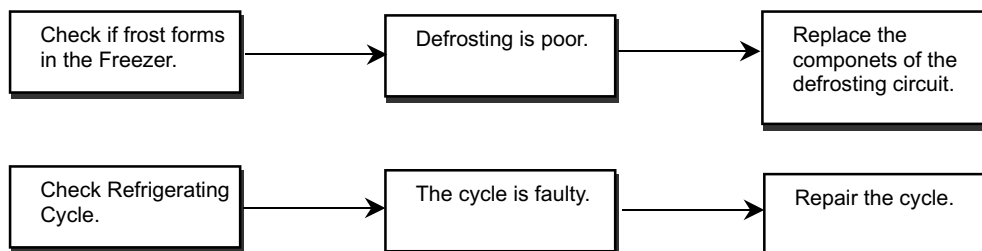

9-5 REFRIGERATING CYCLE

Troubleshooting Chart

CAUSE		REFRIGERAT CONDITION	EVAPORATOR CONDITION	TEMPERATURE OF THE COMPRESSOR	REMARKS
LEAKAGE	PARTIAL LEAKAGE	Freezer and Refrigerator don't get cold normally.	Low flowing sound of refrigerator is heard and frost forms in inlet only.	A little higher than ambient temperature.	1. A little refrigerator has leaked. 2. Refrigerator runs normally if you recharge it.
	WHOLE LEAKAGE	Freezer and Refrigerator don't get cold at all.	Flowing sound of refrigerant is not heard and frost isn't formed.	Equal to ambient temperature.	3. No discharging of refrigerant. 4. Refrigerator runs normally if you recharge it.
CLOGGED BY DUST	PARTIAL CLOG	Freezer and Refrigerator don't get cold normally.	Flowing sound of refrigerant is heard and frost forms in inlet only.	A little higher than ambient temperature	5. Normal discharging of refrigerant. 6. The capillary tube is faulty.
	WHOLE CLOG	Freezer and Refrigerator don't get cold at all.	Flowing sound of refrigerant is not heard and frost isn't formed.	Equal to ambient temperature.	7. Normal discharging of refrigerant.
MOISTURE CLOG		Cooling operation stops periodically.	Flowing sound of refrigerant is not heard and frost melts.	Lower than ambient temperature.	8. Cooling operation restarts when heating the inlet of capillary tube.
DEFECTIVE COMPRESSION	COMPRESSION	Freezer and refrigerator don't get cold.	Low flowing sound of refrigerant is heard and frost forms in inlet only.	A little higher than ambient temperature.	9. Low pressure on high side.
	NO COMPRESSION	No compressing operation.	Flowing sound of refrigerant is not heard and no frost.	Equal to ambient temperature.	10. No pressure of high pressure side in compressor.

Leakage Detection

Check for a leak which may be in the oil discharge in the compressor or in the evaporator.

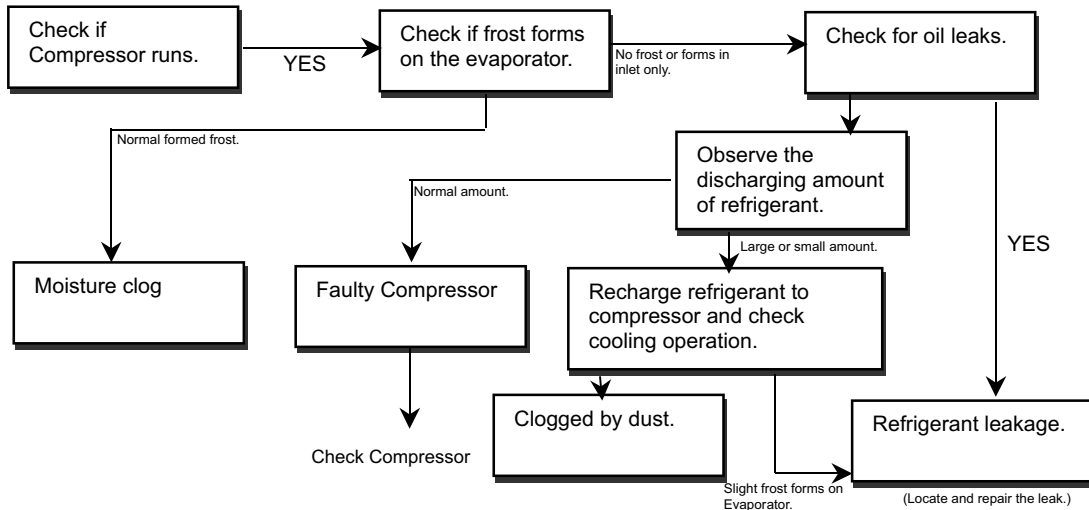

▼ General Control of Refrigerating Cycle.

NO.	ITEMS	CONTENTS AND SPECIFICATIONS	REMARKS
1	WELDING ROD	<ul style="list-style-type: none"> • H₃O Chemical Ingredients Ag: 30%, Cu: 27%, Zn: 23%, Cd: 20% Braze Temperature: 710 ~840°C • BCuP₂ Chemical Ingredients Cu: About 93% P: 6.8 % Rest: within 0.2% Braze Temperature: 735 ~840°C 	<ul style="list-style-type: none"> • Recommended H34 containing 34% Ag in the Service Center.
2	FLUX	Ingredients and Preparation: Borax 60% Fluoridation Kalium: 35% Water: 5%	
3	DRIER ASSEMBLY	<ul style="list-style-type: none"> • Assemble the drier within 30 minutes after unpacking. • Keep the unpacked drier at the temperature of 80~100°C 	<ul style="list-style-type: none"> • Don't store the drier outdoors, because humidity damages it.
4	VACUUM	<ul style="list-style-type: none"> • When measuring with pirant Vacuum gauge of charging M/C, vacuum degree is within 1 Torr. • If the vacuum degree of the cycle inside is 10 Torr. Below for low pressure and 20 Torr. For high pressure, indicates no vacuum leakage state. • Vacuum degree of vacuum pump must be 0.05 Torr. below after 5 minutes. • Vacuum degree must be the same of the value described on item (2) above for more than 20 min. 	<ul style="list-style-type: none"> • Apply M/C Vacuum Gauge without fail. • Perform vacuum operation until a proper vacuum degree is built up. • If a proper vacuum degree is not built up, check the leakage from the Cycle Pipe line parts and Quick Coupler Connecting part.
5	DRY AIR AND NITROGEN GAS	<ul style="list-style-type: none"> • The pressure of dry air must be more than 12~6Kg/cm². • Temperature must be more than -20 ~ -70°C. • Keep the pressure to 12~6Kg/cm² also when substituting dry air for Nitrogen gas. 	
6	NIPPLE AND COUPLER	<ul style="list-style-type: none"> • Check if gas leaks with soapy water. • Replace Quick Coupler in case of leakage. 	<ul style="list-style-type: none"> • Check if gas leaks from connecting part of coupler.
7	PIPE	<ul style="list-style-type: none"> • Put all joint pipe in a clean box and cover tightly with the lid so dust or humidity do not contaminate. 	

10. DESCRIPTION OF FUNCTION & CIRCUIT IF MICOM

10-1 FUNCTION

10-1-1 FUNCTION

1. When the appliance is plugged in, it is set to Medium. Each time the button is pushed, it cycles through Medium → Medium/High → High → Low → Medium/Low → Medium.
2. When the power is initially applied or restored after a power failure, it is automatically set to Medium.

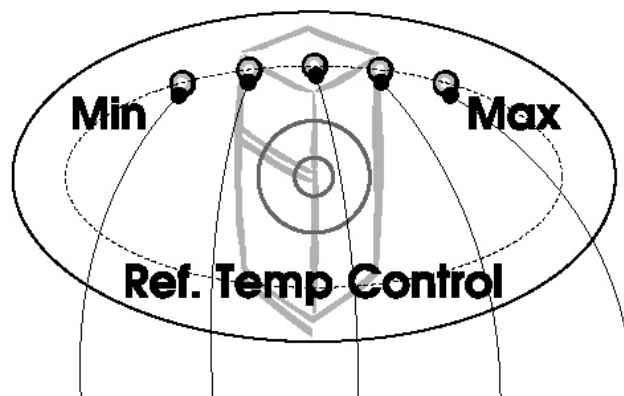

Temperature Control	Low	Medium Low	Medium	Medium High	High
TEMP °F (°C)	46.4 (8)	39.2 (4)	37.4 (3)	34.7 (1.5)	30.2 (-1)
ROOM	REFRIGERATOR				

10-1-2 DEFROSTING

1. The defrosting is performed each time when the total running time of the compressor reaches 10 hours.
2. After the power is turned on (or restored after a power failure), the defrosting starts when the total running time of the compressor reaches 4 hours.
3. When the temperature of the defrosting sensor reaches 13 °C or above, the defrosting stops. If the temperature does not reach 13 °C in 2 hours after the defrosting starts, the defrosting error code is displayed. (Refer to 7-1-4 Error Diagnostic Mode).
4. With the defective defrosting sensor (cut or short-circuited wire), the defrosting will not be performed.

10-1-3 SEQUENTIAL OPERATION OF ELECTRIC COMPONENTS



The electric components, such as the compressor, defrosting heater, and cooling fan, starts sequentially to avoid noise and damage to the part which may result from the simultaneous start of various components on turning the power on or after the completion of a test.





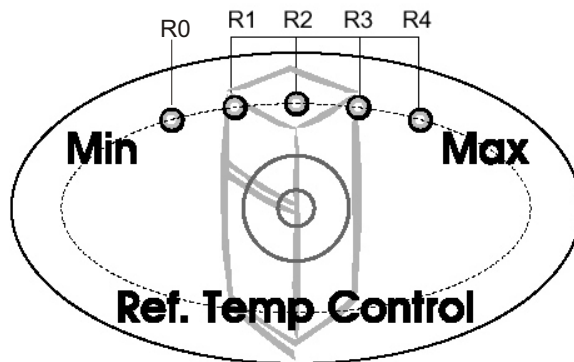





Condition of Operation		Operating Sequence	
When the power is turned on	If the temp of the defrosting sensor is 25 °C or above (For the initial use after the purchase or grounding)	POWER ON	in 0.5 sec → COMP & COOLING FAN ON
	If the temp of the defrosting sensor is below 25 °C (After a power failure or SVC)	POWER ON	in 0.5 sec → DEFROSTING HEATER ON in 10 sec → DEFROSTING HEATER OFF in 0.5 sec → COMP & COOLING FAN ON

10-1-4 ERROR DIAGNOSTIC MODE

1. The error diagnostic mode indicates when a fault may affect the performance of the product occurs while operating the product.
2. Even if a function control button is pushed when an error occurs, the function will not be performed.
3. When the error is cleared while the error code is displayed due to a fault, the refrigerator returns to the normal condition (Reset).
4. The error code is displayed by the refrigerator temperature indication LED on the display of the refrigerator while the remaining LEDs are off.



 : ON
  : OFF
  : NORMAL

NO	Error	Error Code Display					Cause	State of Operation with Error	
		R0	R1	R2	R3	R4		Comp / Cooling fan	Defrosting heater
1.	Faulty refrigerator(R) sensor (on the control box of the refrigerator)	●	●		●	●	Cut or short-circuited wire of refrigerator sensor	15 min ON/ 15 min OFF	
2.	Faulty defrosting sensor	●	●	●		●	Cut or short-circuited wire of defrosting sensor		No defrosting
3.	Defrosting failure	●					Cut or disconnected wire of defrosting heater or temperature fuse(indicated at least 4 hours later after the error occurs)		

10-2 PCB FUNCTION POWER CIRCUIT

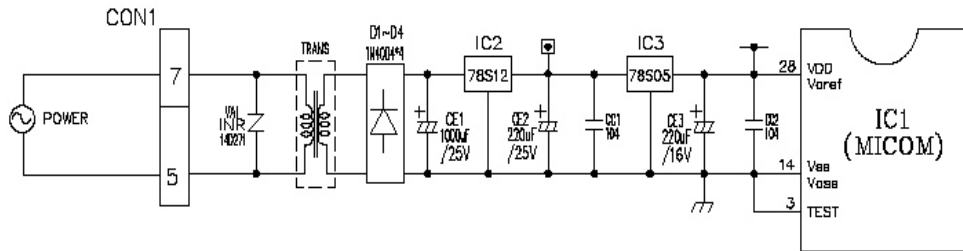

The second part of the Transformer is composed of the power supply for the display and relay drive (12 Vdc) and for the MICOM and IC (5 Vdc).
The voltage for each part is as follows:

PARTE	VA1	CE2	CE3
VOLTAJE	115 VAC	12VDC	5VDC

VA1 prevents overvoltage and noise. When 175 V or higher power is applied, the inside elements are short-circuited and broken, resulting in the blowout of the fuse in order to protect the elements of the secondary part of the Transformer.

10-2-2 OSCILLATION CIRCUIT

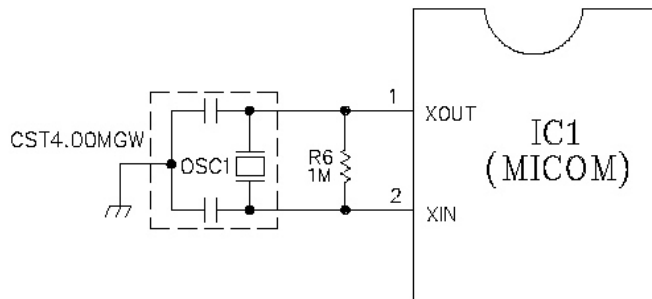

This circuit is to generate the base clock for calculating time and the synchro clock for transmitting data to and from the inside logic elements of the IC1 (MICOM). Be sure to use the exact replacement parts since the calculating time by the IC1 may be changed or it will not work if the OSC1 SPEC is changed.

10-2-3 RESET CIRCUIT

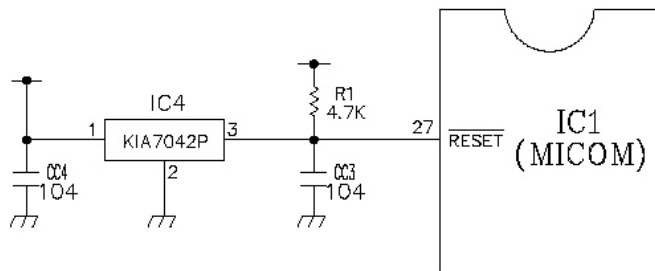

The reset circuit is for allowing all the functions to start at the initial conditions by initializing various parts including the RAM inside the MICOM (IC1) when the power is initially supplied or the power supply to the MICOM is restored after a momentary power failure. For the initial 10 ms of power supply, LOW voltage is applied to the MICOM RESET terminal. During a normal operation, 5 V is applied to the RESET terminal. (If trouble occurs in the RESET IC, the MICOM will not work).

10-2-4 LOAD DRIVE CIRCUIT

1. Load Drive Condition Check

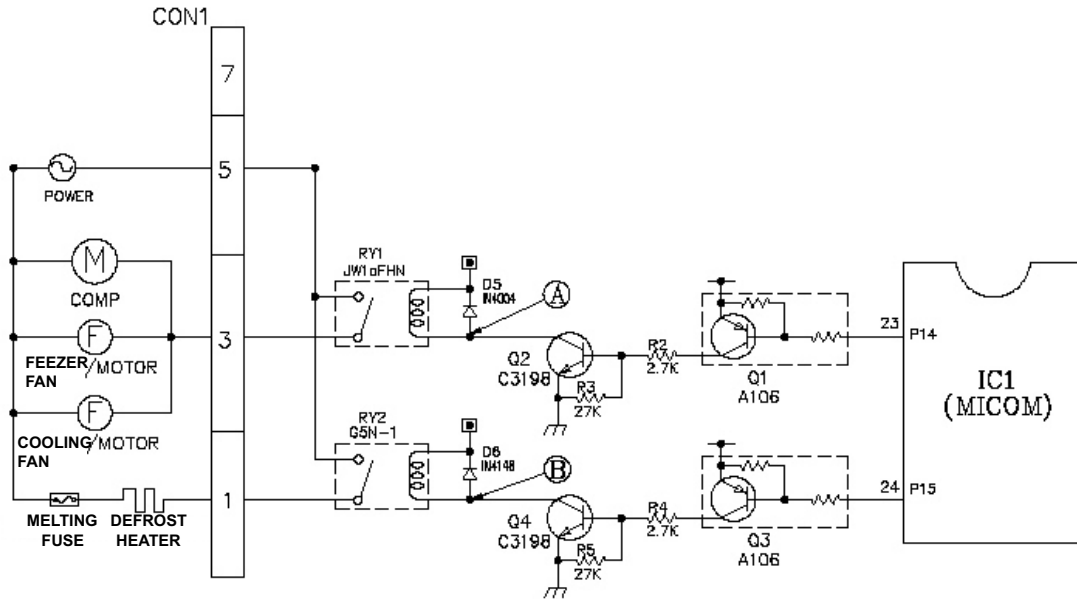

Load Type		Compressor, Freeze Fan Motor	Defrosting Heater
Measurement Location		Ⓐ	Ⓑ
Condition	ON	1 V or below	
	OFF	12 V	

10-2-5 TEMPERATURE SENSOR CIRCUIT

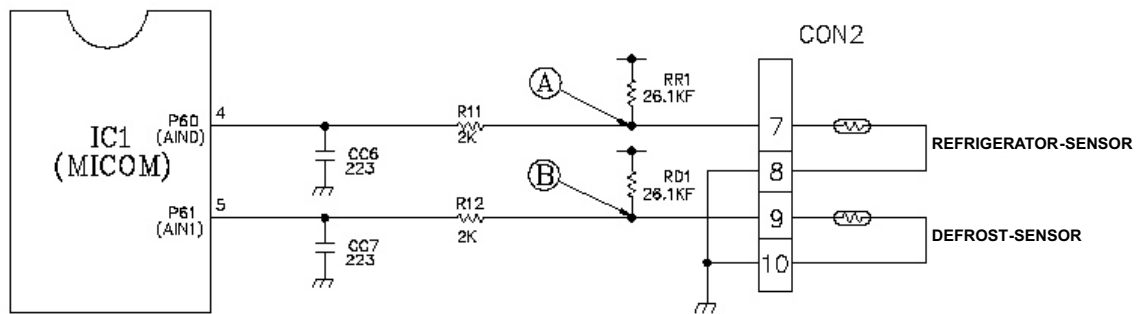



The upper CIRCUIT reads REFRIGERATOR temperature and DEFROST - SENSOR temperature for defrosting into MICOM. OPENING or SHORT state of each TEMPERATURE SENSOR are as follows:

SENSOR	CHECK POINT	NORMAL (-30 -50)	SHORT-CIRCUITED	OPEN
Refrigerator Sensor	POINT(A) Voltage	0.5 V 4.5 V	0 V	5 V
Defrosting Sensor	POINT(B) Voltage			

10-2-6 TEMPERATURE COMPENSATION & OVERCOOLING/UNDERCOOLING COMPENSATION CIRCUIT

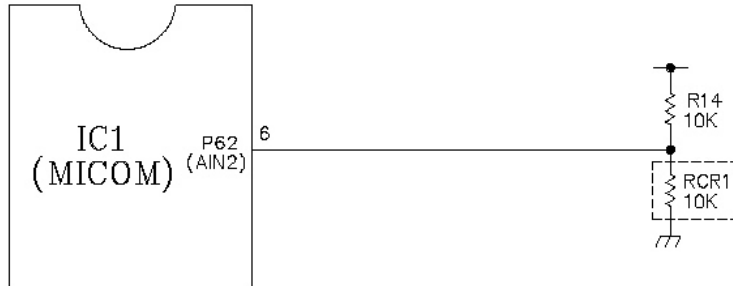
1. Refrigerator Temperature Compensation



Refrigerator		Remark
Resistance (RCR1)	Temperature Compensation °F (°C)	
180 KW	41 (+5.0)	Compensation by raising the temperature 
56 KW	39.2 (+4.0)	
33 KW	37.4 (+3.0)	
18 KW	35.6 (+2.0)	
12 KW	35.24 (+1.8)	
10 KW	32 (0)	Standard Temperature
8.2 KW	30.2 (-1.0)	Compensation by lowering the temperature 
5.6 KW	28.4 (-2.0)	
3.3 KW	26.6 (-3.0)	
2 KW	24.8 (-4.0)	
470 KW	23 (-5.0)	

➡ Table of Temperature Compensation by adjusting the resistance (Difference with the current temperature).

Example. If the refrigerator compensation resistance (RCR1) is changed from 10 K (the current resistance) to 18 K (the adjustment resistance) of the refrigerator rises 33.8°F (+1°C).

10.2.7 KEY BUTTON INPUT & DISPLAY LIGHT ON CIRCUIT

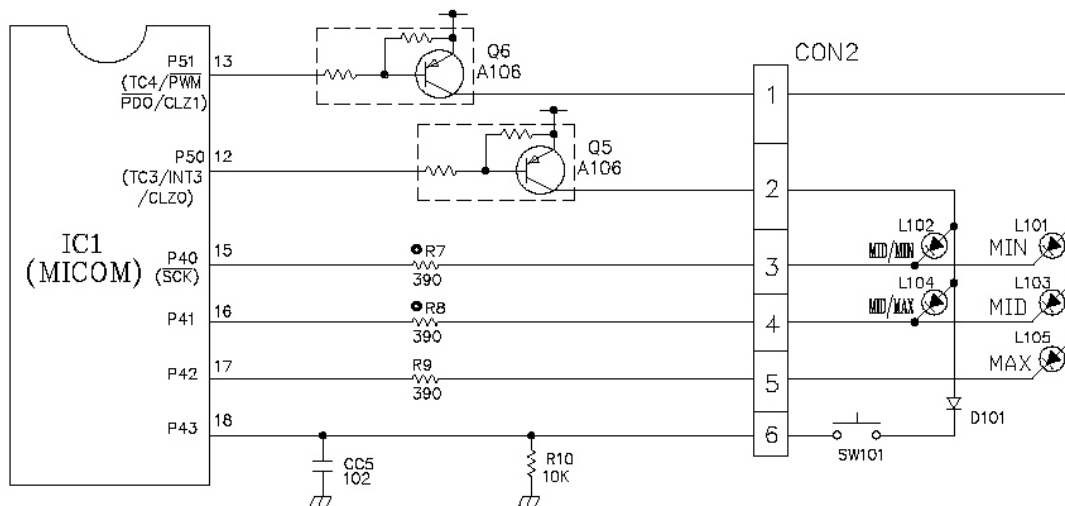

➡ The circuit shown above is to determine whether a function control key on the operation display is pushed and to turn on the corresponding function indication LED. The drive type is the scan type.

10-3. RESISTANCE SPECIFICATION OF SENSOR

TEMPERATURE SENSOR		RESISTANCE OF REFRIGERATOR (DEFROST) SENSOR
°F	(°C)	
-4	-20	77 kW
5	-15	66 kW
14	-10	47.3 kW
23	-5	38.4 kW
32	0	30 kW
41	+5	24.1 kW
50	+10	19.5 kW
59	+15	15.9 kW
68	+20	13 kW
77	+25	11 kW
86	+30	8.9 kW
104	+40	6.2 kW
122	+50	4.3 kW

1. The resistance of SENSOR HAS 5% common difference.
2. Measure the resistance of SENSOR after leaving it over 3 minutes in measuring temperature. This postponing is necessary because of perceiving speed.

10-4. TROUBLE SHOOTING

* Replace the PWB when there's no trouble after checking the contents of trouble.

CLASSIFICATION	STATE OF TROUBLE	POINTS TO CHECK	CHECKING METHOD	CONTENT	REMEDY
POWER SOURCE	<ul style="list-style-type: none"> · At the DISPLAY LED OFF. · DISPLAY LED represents abnormal operation. 	<ol style="list-style-type: none"> 1. FREEZER/REFRIGERATOR. 2. LAMP is dim. 3. The connection of MAIN PWB CONNECTOR. 	<p>FREEZER/REFRIGERATOR door open. Verify the correct bulb is used. Check the connector.</p>	POWER SOURCE is incorrect. Is the voltage correct? connector connection is poor. Transformer Fuse open.	Certify Fuse. Certify outlet voltage. Use boosting Transformer. Reconnect CONNECTOR. Replace Transformer
				<ol style="list-style-type: none"> 1. Does compressor operate? 	COMPRESSOR lock or blocked. OLP or PTC is defective. COMPRESSOR RELAY is defective. CONNECTING WIRE is defective.
COOLING	<ol style="list-style-type: none"> 1. NO COOLING 	<ol style="list-style-type: none"> 2. Does refrigerant leak. 	Measure the amount of frost on Evaporator and the surface temperature of condenser pipe.	Refrigerant leakage.	Repair the leak and recharge the refrigerant.
			<ol style="list-style-type: none"> 1. Does FAN MOTOR operate? 	FAN MOTOR is defective. DOOR LINER contact. CONNECTING WIRE is defective.	Replace FAN MOTOR. Replace DOOR LINER. Verify MOTOR and the connection of the black wire of MAIN PWB CONNECTOR (CON1).
			<ol style="list-style-type: none"> 2. Is DEFROSTING normal? 	Certify the amount of frost on evaporator.	Poor DEFROSTING.
		<ol style="list-style-type: none"> 3. Is SENSOR normal? 	Check the SENSOR resistance in the refrigerator.	SENSOR RESISTANCE is incorrect.	Replace SENSOR.

CLASSIFICATION	STATE OF TROUBLE	POINTS TO CHECK	CHECKING METHOD	CONTENT	REMEDY
POOR COOLING	REFRIGERATOR TEMPERATURE is too warm.	1. Is FREEZER TEMPERATURE normal? 2. Does the FAN MOTOR blow enough cool air?	See if FREEZER TEMPERATURE is too warm. Check the amount and speed of cool air being supplied inside the refrigerator.	FAN MOTOR is poor. AIR FLOW blocked. EVAPORATOR frozen.	Be sure door closes. Replace FAN MOTOR. Remove Impurities. See POOR DEFROSTING.
POOR DEFROSTING	NO DEFROSTING.	1. Does HEATER emit heat?	Check the main PWB.	HEATER disconnection. TEMPERATURE FUSE disconnection. Poor Connection. DEFROST SENSOR is defective. HEATER RELAY is defective.	Replace HEATER. Replace TEMPERATURE FUSE. Check evaporator connection and wire of MAIN PWB CONNECTOR. Replace DEF-SENSOR. Replace RY2 of MAIN PWB.
		2. Is the DRAIN PIPE blocked?	Check DRAIN PIPE.	DRAIN PIPE is blocked.	Remove ice and impurities. Check HEATER PLATE.
		3. Does ice remains after DEFROSTING?	Check the attachin of DEFROST-SENSOR. Check the gap in the door gasket.	Attachment is incorrect. DOOR sealing is incorrect.	Reassemble DOOR. Replace GASKET.

10-5 MAIN PWB ASSEMBLY AND PARTS LIST.
 10-5-1 MAIN PWB ASSEMBLY.

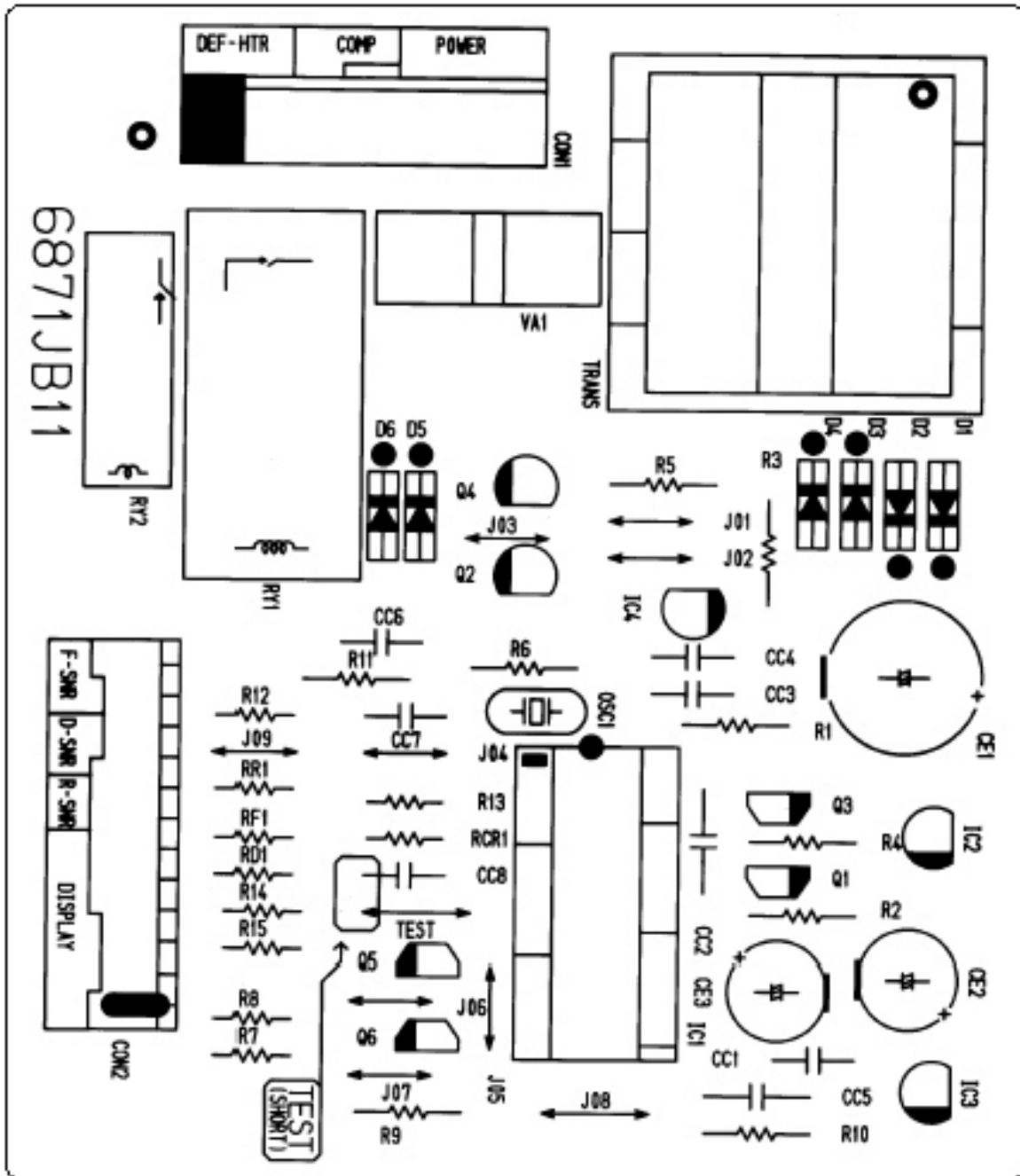

Replacement Parts List

No	P/NO	DESCRIPTION	SPEC	MAKER	REMARK
1	6870JB2062B	PWB(PCB),MAIN	GR-T462 (AL-PJT),R-B29 (HM-PJT)	DOO SAN	T=1.6
* 2	6170JB2014D	TRANSFORMER,LOW VOLT	115V 15V YES 50,60HZ HM-PJT	TAE SUNG	-
2	6170JB2014B	TRANSFORMER,LOW VOLT	140V 15V YES 50HZ AL-PJT	TAE SUNG	-
2	6170JB2014A	TRANSFORMER,LOW VOLT	240V 15V YES 50HZ HM-PJT	TAE SUNG	-
2	6170JB2014C	TRANSFORMER,LOW VOLT	260V 15V YES 50HZ HM-PJT	TAE SUNG	-
3	6630JB8001W	CONNECTOR (CIRC),WAF	JE202-1T-04 JAE EUN 7PIN 3.96MM STRAIGH	JAE EUN	CON1
4	6630JB8007J	CONNECTOR (CIRC),WAF	917788-1 AMP 10PIN 2.5MM STRAIGHT SN	AMP	CON2
5	01ZZJB2004E	IC,DRAWING	TMP87C409N 28BDIP BK [MASK] AL12-PJT	TOSHIBA	IC1(=01ZZJB2004F) (A,B,C,
5	01ZZJB2004Q	IC,DRAWING	TMP87C409N 28BDIP BK [MASK] AL3-PJT	TOSHIBA	IC1(=01ZZJB2004R) (A,B,C,
5	01ZZJB2004S	IC,DRAWING	TMP87C409N 28BDIP BK [MASK] AL5-PJT	TOSHIBA	IC1(=01ZZJB2004T)
6	01KE781200E	IC,KEC	KIA78S12P ST U 12V 1A,KEC ----	KEC	IC2
7	01KE780500A	IC,KEC	KIA78S05P PIN,DJKEC	KEC	IC3
8	01KE704200A	IC,KEC	KIA7042P 3P BK RESET	KEC	IC4
-	01KD010100A	IC,KODENSHI	BMR-0101D 3P TP RESET	KODENSHI	-
9	6920000001A	RELAY	ALE15B12ATSUSHITA 12V 4400000	NAIS	RY1
10	6920JB2003A	RELAY	G5N-1A OMRON (JAPAN)DC12V 16.7	OMRON	RY2
11	6212JB8001B	RESONATOR	CSTS0400MG03 MURATA 4MHZ TP	MURATA	OSC1(=J570-00012A)
* 12	6102W5V006A	VARISTOR	SVC271D-14A SAMWHA UL/CSA/VDE TP	SAM HWA	VA1
12	6102JB8001A	VARISTOR	SVC621D-14A SAMWHA UL/VDE BK 620V	SAM HWA	VA1
13	0DD404009AA	DIODE,RECTIFIER	1N4004TA TP KEC	DELTA PYUNG CHANG	D1-5
14	0DD414800AA	DIODE	1N4148 SWIT 0.5W	ROHM	D6
15	0CE108BJ610	CAPACITOR,FIXED ELEC	1000UF KME TYPE 25V5V BULK	SAM HWA	CE1 (105C RG/RD TYPE)
16	0CE227DH638	CAPACITOR,FIXED ELEC	220UF STD 25V 20% TP 5 FM5	SAM HWA	CE2 (105C RG/RD TYPE)
17	0CE227DF638	CAPACITOR,FIXED ELEC	220UF STD 16V 20% TP 5 FM5	SAM HWA	CE3 (105C RG/RD TYPE)
43	0CE106EK638	CAPACITOR,FIXED ELEC	10UF RG,RD 50V 20% TP 5 FM5	SAM HWA	CE4 (105C RG/RD TYPE)
18	0CK1040K909	CAPACITOR,FIXED CERA	100000PF 50V Z A TA52	TAE YANG	CC1-4
19	0CK2230K909	CAPACITOR,CERAMIC (H	22NF D 50V Z A TA52	TAE YANG	CC6,7
20	0CK1020K909	CAPACITOR,CERAMIC (H	0.001 UF 50V Z A TA52	TAE YANG	CC5
21	0RD3900F609	RESISTOR,FIXED CARBO	390 OHM 1/6 W 5.00% TA52	-	R7,8
22	0RD3900G609	RESISTOR,FIXED CARBO	390 OHM 1/4 W 5.00% TA52	-	R9
23	0RD2001F609	RESISTOR,FIXED CARBO	2K OHM 1/6 W 5.00% TA52	-	R12
24	0RD2001F609	RESISTOR,FIXED CARBO	2K OHM 1/6 W 5.00% TA52	-	R11
25	0RD2701G609	RESISTOR,FIXED CARBO	2.7K OHM 1/4 W 5% TA52	-	R2,4
26	0RD4701F609	RESISTOR,FIXED CARBO	4.7K OHM 1/6 W 5.00% TA52	-	R15
27	0RD4701G609	RESISTOR,FIXED CARBO	4.7K OHM 1/4 W 5.00% TA52	-	R1
28	0RD1002F609	RESISTOR,FIXED CARBO	10K OHM 1/6 W 5.00% TA52	-	R14
29	0RD1002G609	RESISTOR,FIXED CARBO	10K OHM 1/4 W 5.00% TA52	-	R10
30	0RD2702G609	RESISTOR,FIXED CARBO	27K OHM 1/4 W 5.00% TA52	-	R3,5
31	0RD1002F609	RESISTOR,FIXED CARBO	10K OHM 1/6 W 5.00% TA52	-	RCR1
32	0RD1004G609	RESISTOR,FIXED CARBO	1M OHM 1/4 W 5.00% TA52	-	R6
33	0RN2612F409	RESISTOR,FIXED METAL	26100 OHM 1/6 W 1% TA52	-	RR1 ~
34	0RN2612F409	RESISTOR,FIXED METAL	26100 OHM 1/6 W 1% TA52	-	RD1
35	0TR106009AC	TRANSISTOR	KRA106M(KRA2206) TP KEC	KEC	Q1,3,5,6
36	0TR319809CA	TRANSISTOR	KTC3198 TP KEC DIP	KEC	Q2,4
37	43607015	WIRE,JUMP	GC10 WHITE T0.6 L10 FOR A INSR	-	J1-4,6,7,CC8
38	43607015	JUMP WIRE	0.6MM 10MM - - -	-	J8,9,TEST
39	SS0000008AA	SOLDER,SOLDERING	SR-34 PB FREE LFM-48	HEE SUNG	SOLD'
3.0	SSWZU-L05AA	SOLDER,SOLDERING	LFM-38,SN3.0AG-0.5CU% 3.0MM	DAE JIN	-
41	7245ZB0004A	FLUX	SV-PBF-06 KSK 12.5 WT% 0.815+-0.003	KOKI	-
42	6102W5V007A	VARISTOR		IL JIN	VA1

RATING	115 V
TRANSFORMADOR	6170JB2017C
VARISTOR	6102W5V007A

RATING	115 V		
TRANSFORMER	6170JB2014D		
VARISTOR	6102W5V006A		

10.6 PWB DIAGRAM

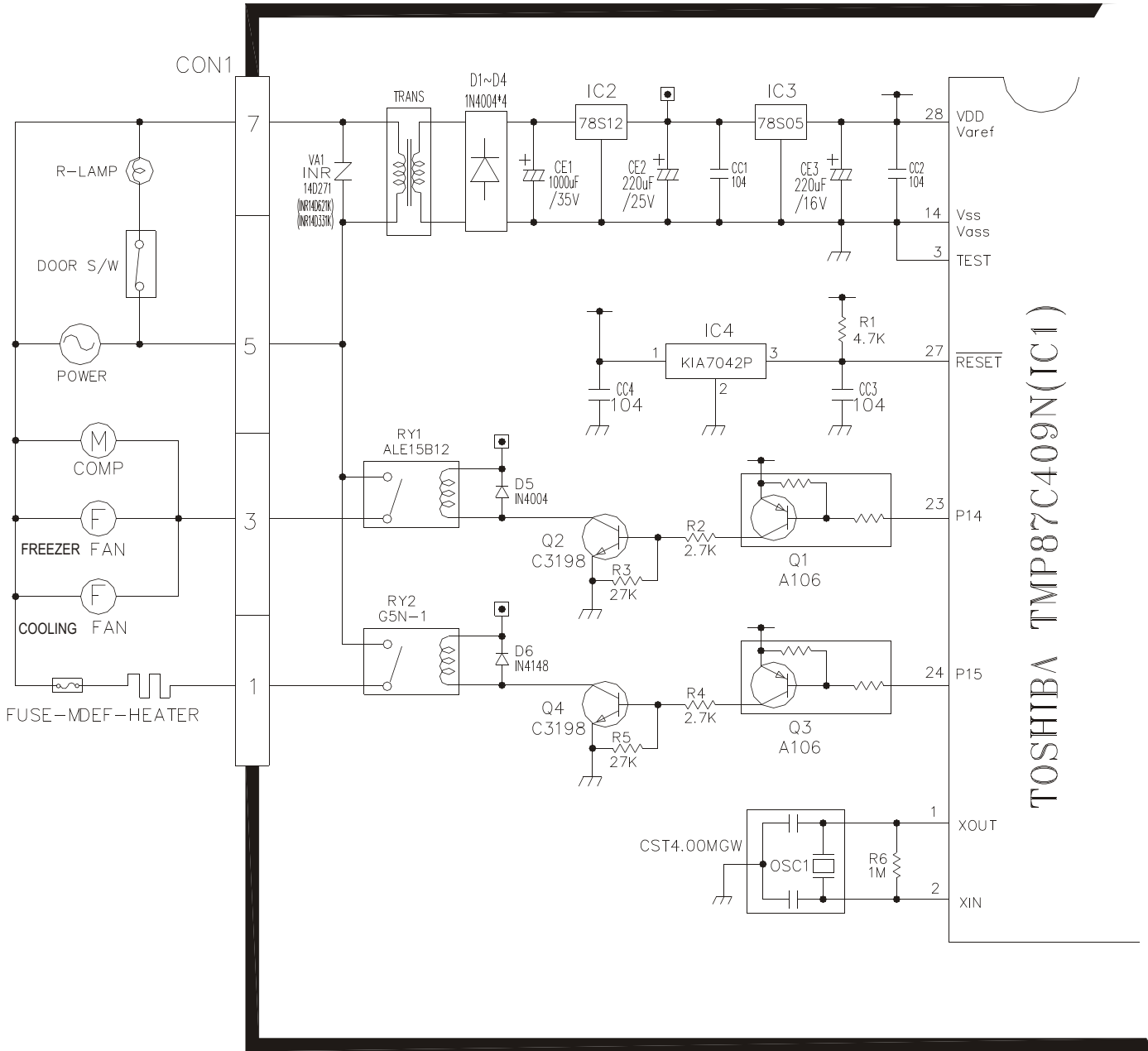

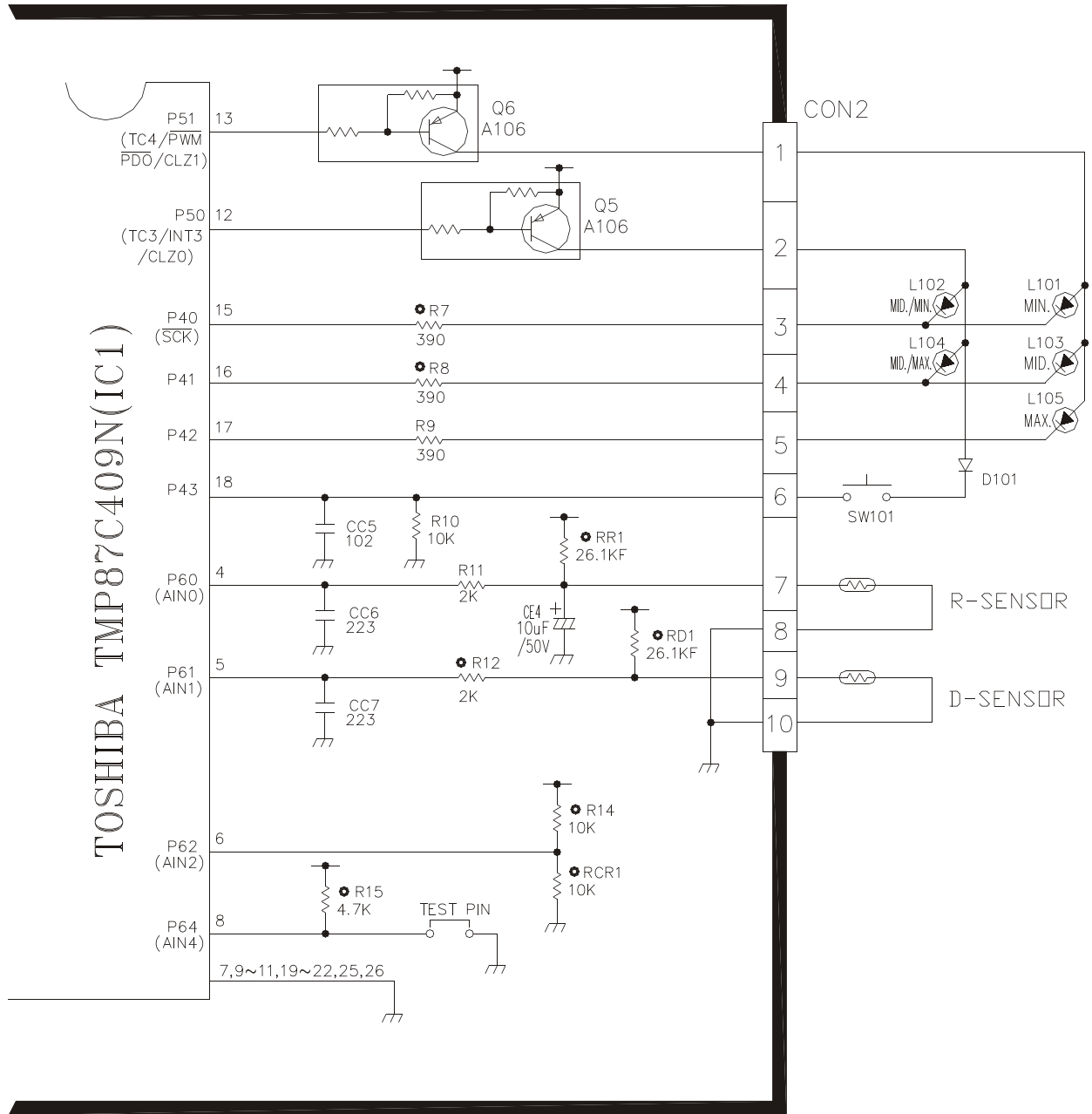

11. EXPLODED VIEW

9 pies

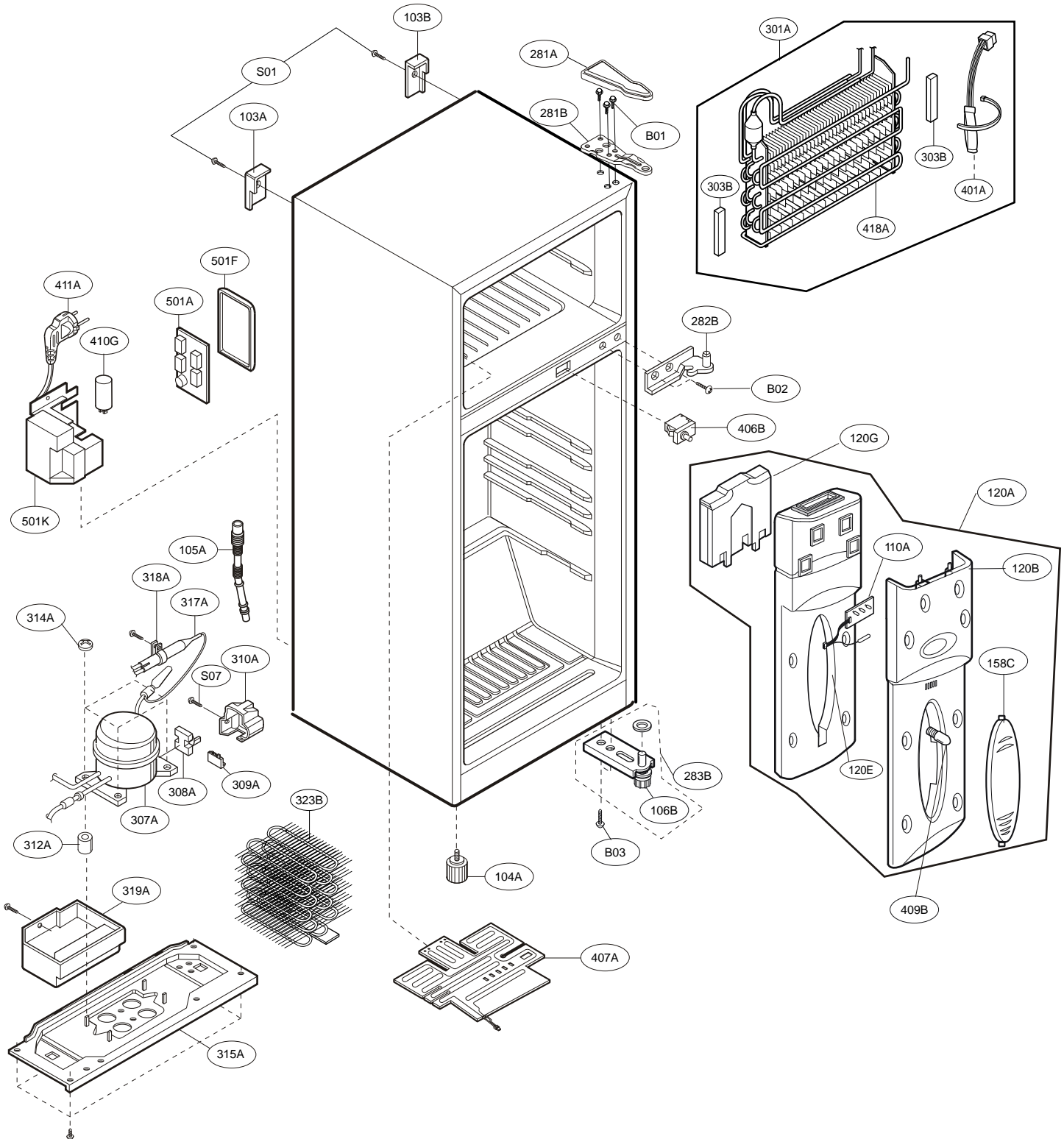

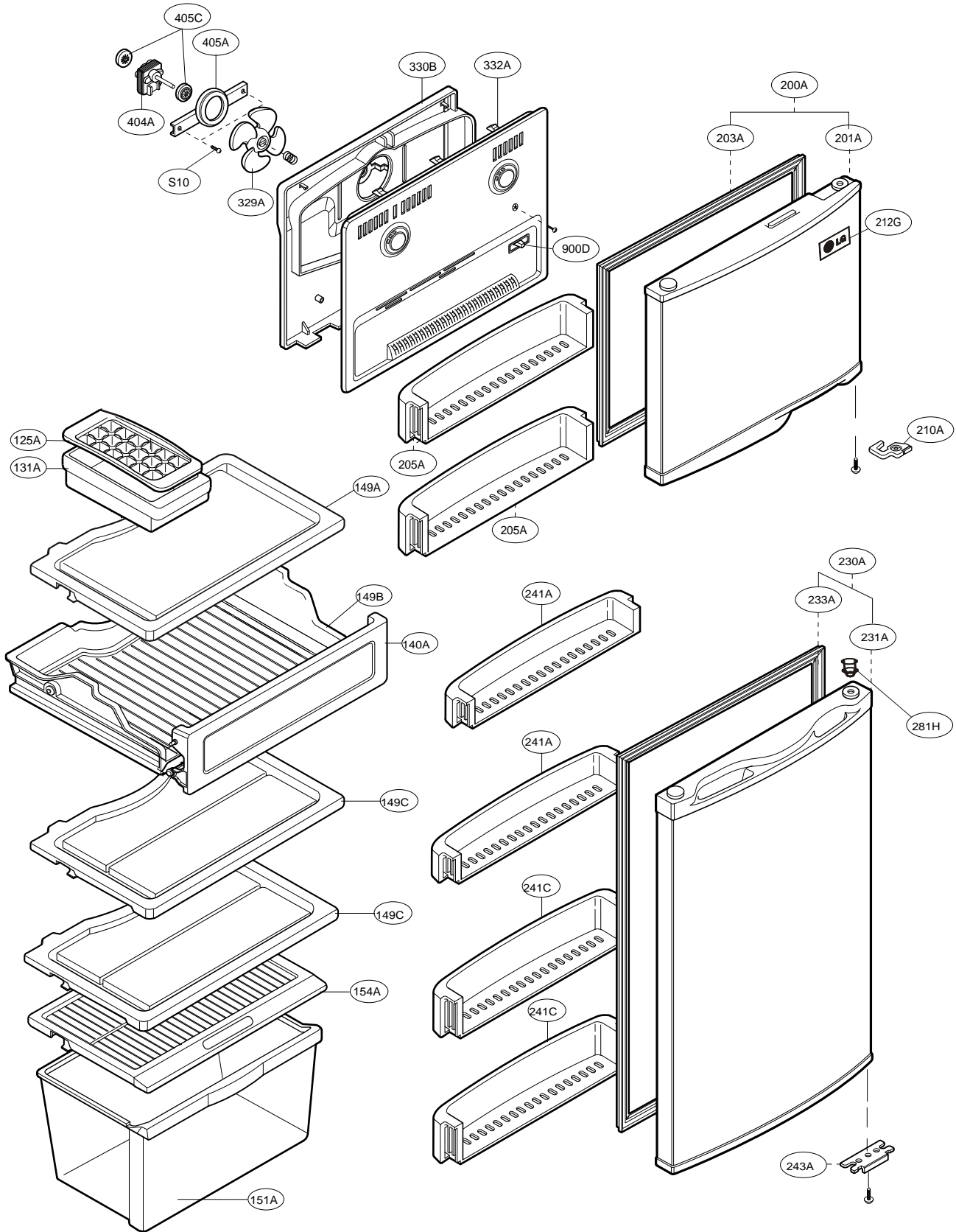

LRTN09314SW

LOC NO	PART NO	DESCRIPTION	LOC NO	PART NO	DESCRIPTION
103A	3650JJ2003E	Handle,Rear	301A	ADL30264203	Evaporator Assembly
103B	3650JJ2003A	Handle,Rear	303B	4827JJ3001B	Insulation Assembly
104A	4779JA2011A	Leg Assembly,Adjust	307A	2521CR0363C	Compressor,Assembly
105A	5250JA2009A	Tube,Drain	308A	EBG32606502	Thermistor Assembly,PTC
106B	4778JA2007A	Leg,Adjust	309A	6750CR0004S	Overload Protect
110A	6871JB2036A	PCB Assembly,Display	310A	3550JA2059A	Cover,PTC
120A	4995JJ1002F	Case Assembly,Control Refrigerator	312A	5040JA3074A	Damper,Compressor
120B	4994JJ1003B	Case,Control Refrigerator	314A	4620JA3009A	Stopper,Compressor
120E	5208JJ1007A	DUCT,INSULATION	315A	3103JJ2002A	Base Assembly,Compressor
120G	5208JJ2002A	DUCT,INSULATION	317A	5851JJ2002F	Drier Assembly
125A	3390JJ1010A	Tray,Ice	318A	4930JA3034A	Holder,Drier
131A	5074JJ1003B	Bucket,Ice	319A	3390JJ1006A	Tray,Drip
140A	3580JJ1001B	Door,Fresh Room	323B	5403JJ1002A	Condenser Assembly,Plate(Rear)
149A	5026JJ1011B	Shelf,Freezer	329A	5901JJ1002A	Fan Assembly
149B	3390JJ1007B	Tray,Fresh Room	330B	4998JJ1002A	Shroud,Freezer
149C	5026JJ1012B	Shelf,Refrigerator	332A	3531JJ2001C	Grille Assembly,Fan
151A	3391JJ1004A	Tray Assembly,Vegetable	401A	6615JB2002T	Controller Assembly
154A	3550JJ1005B	Cover,TV	404A	4680JB1033B	AC Motor
158C	3550JJ2005B	Cover,Lamp	405A	4810JA3007A	Bracket,Motor
200A	ADC32629201	Door Assembly,Freezer	405C	J75600008B	Damper,Motor Support
201A	ADD32629501	Door Foam Assembly,Freezer	406B	6600JB1002K	Switch,Push Button
203A	4987JJ1004P	Gasket Assembly,Door	407A	5300JB1075F	Heater,Plate
205A	5004JJ1011B	Basket,Door	409B	6912JB2002J	Lamp,Incandescent
210A	4620JJ2002A	STOPPER,HANDLE	410G	0CZZJB2010G	Capacitor,Electric Appliance Film,Radial
212G	3846JD1009D	Name Plate	411A	6411JK2001A	Power Cord Assembly
230A	ADC32629401	Door Assembly,Refrigerator	418A	5300JB1078F	Heater,Sheath
231A	ADD32629601	Door Foam Assembly,Refrigerator	501A	6871JB1115A	PCB Assembly,Main
233A	4987JJ1004Q	Gasket Assembly,Door	501F	3550JJ2010A	Cover,PCB
241A	5004JJ1012B	Basket,Door	501K	3110JJ1003A	Case,PCB
241C	5004JJ1013B	Basket,Door	900D	4940JJ2002A	Knob,Shutter
243A	4810JA3008A	Bracket,Door	B01	J35100004L	Screw,Customized
281A	3550JJ2006A	Cover,Hinge	B02	J35100004R	Screw,Customized
281B	J33400020A	Hinge Assembly,Upper	B03	J35100004F	Screw,Customized
281H	5006JJ3003A	Cap,Hinge	S01	4J01425A	Screw,Customized
282B	4775JA3009B	Hinge Assembly,Center	S10	4001JA3001A	Screw Assembly
283B	4775JJ2001A	Hinge Assembly,Lower			



P/No. 3828JD8331B Rev.1

Julio, 2008