

This Owner's Manual is provided and hosted by [Appliance Factory Parts](#).



Country Smokers CS-570 Owner's Manual

[Shop genuine replacement parts for Country Smokers
CS-570](#)



[Find Your Country Smokers Grill Parts - Select From 7 Models](#)

----- Manual continues below -----



Series 3

Owners Manual



Models

420

450

570

680

**You must read this Owner's Guide
before operating your grill**

revised 0509



Mesquite
Hickory
Cherry
Apple
Alder

Sear • Barbecue • Smoke • Grill • Roast • Bake

DANSONS

Toll Free 1-877-303-3134

Savor the Flavor!

www.louisiana-grills.com



Dear "Country Smoker" Wood Pellet Barbecue Owner:

Thank you for choosing to purchase a "Louisiana Grill Country Smoker" wood pellet smoking grill.



Cooking with your Louisiana Wood Pellet Grill is about to bring you full circle from the days of the caveman when cooking outdoors with wood was a necessity, to cooking indoors in your modern kitchen and now back to the great outdoors and that savory wood flavor.

Think of your "Louisiana Grill" as an extra stove available to bake, roast, grill, sear and smoke food. Anything that can be done in your indoor kitchen can be done on your grill.

Barbecuing is a culture all on its own. Barbecuing provides a form of entertainment, which is relaxed and casual. Your meals can be completely cooked outdoors and the chef is one of the crowd. Keep it simple, be creative, and have some fun.

We'd like to take this opportunity to pass on a few *important tips* concerning grilling with wood pellets.

- *Initial set-up of our "Louisiana Grill" is the most important step* to ensure the efficient and satisfactory operation of your barbecue for many years to come.
- *Be diligent in your cleaning and maintenance program.* Taking care of your grill will add years of life and keeps it looking great.
- Use only all natural wood pellets designed to burn in pellet grills.
- Ensure your pellet fuel stays moisture free. Open bags of fuel should be stored in an airtight container and empty the hopper if you are not using the grill over longer periods.

Our loyal staff, valued customers, friends and our loving families have all contributed recipes to our cookbook. We have tried to include a broad range of cuisines and styles, starting with Mom's Great Home Cooking and many, many, many, catering and entertaining experiences to current classics and new soon to be classics.

WE WANT YOU!

If you are interested in contributing a family favourite, use the supplied template or down load it from the web. Fill the form out and please send it by:

Fax: 1-877-303-3135, Web www.louisiana-grills.com, or to the address below.

Now go, fill up the hopper, light up that grill and get ready to **SAVOR THE FLAVOR!**

CAUTION! be prepared for never ending compliments.

DANSONS

Dansons Inc.



COPYRIGHT NOTICE

Copyright 2009, Canadian Comfort Industries, a Dansons Inc. company.

All rights reserved.

No part of this manual may be copied, transmitted, transcribed, stored in a retrieval system, in any form or by any means without the expressed written permission of,

DANSONS

Dansons Inc.
14648—134th Ave., Edmonton, AB, Canada T5L 4T4

Contents

| | |
|-----------------------------------|----|
| DANGERS & WARNINGS | 4 |
| UNPACKING YOUR COUNTRY SMOKER | 5 |
| ASSEMBLY INSTRUCTIONS | |
| WHEELS & LEVELERS | 6 |
| SERIES 3 HOPPER ASSEMBLY | 7 |
| BURN POT, FLAVOR GUARD & HANDLE | 9 |
| GRIDS, THERMOMETER, BUCKET | 10 |
| KNOWLEDGE IS POWER | |
| HOW YOUR COUNTRY SMOKER WORKS | 11 |
| SPECS | 12 |
| ARCHED FLAVOR GUARD | 13 |
| IGNITER | 13 |
| BURN POT & BURN GRATE | 13 |
| AUGER FEEDS | 13 |
| LOUISIANA GRILLS STANDARD CONTROL | 14 |
| HOPPER | 15 |
| POWDER COAT FINISH | 15 |
| COOKING GRIDS | 15 |
| GREASE BUCKET | 15 |
| ABOUT WOOD PELLETS | 16 |
| OPERATION | |
| SET-UP PROCEDURE | 17 |
| GETTING STARTED | 18 |
| LIGHTING - AUTOMATIC | 20 |
| LIGHTING - MANUAL | 21 |
| SHUTTING OFF YOUR SMOKER | 22 |
| MAINTENANCE | |
| GENERAL | 22 |
| WIRING DIAGRAM | 25 |
| LIMITED WARRANTY | 26 |
| PARTS & SERVICE | 28 |



Dangers & Warnings

Failure to follow the Dangers, Warnings and Cautions contained in this Owner's Manual may result in serious bodily injury or death, or in a fire or cause damage to property.

DO NOT PLACE THE "TAILGATE" MODEL DIRECTLY ON A COMBUSTIBLE SURFACE. THERE MUST BE A NON-COMBUSTIBLE SURFACE BETWEEN THE SMOKER AND A COMBUSTIBLE SURFACE.

- Do not store a spare or disconnected liquid propane cylinder under or near this barbecue.
- After a period of storage, and/or non-use, the Louisiana Grill Barbecue should be checked for burn grate obstructions, burn pot setting and hopper before use. See instructions in this manual for correct procedures
- Do not put a barbecue cover or anything flammable on, or in the storage space area under the barbecue.
- Children should never use your Country Smoker barbecue, while unattended. Accessible parts of the barbecue may be very hot. Keep young children away while it is use.
- You should exercise reasonable care when operating your Louisiana Grill barbecue. It will be hot during cooking or cleaning and should never be left unattended or moved while in operation.
- Do not use lava rock, wood chucks or charcoal in your Country Smoker.
- Never lean over open grill or place hands or fingers on the front edge of the cooking box or in the hopper.
- Should a grease fire occur, turn "Off" the control and leave lid closed until the fire is out.
- Do not enlarge burn grate orifices, igniter holes or burner pots.
- "Country Smokers" should be cleaned on a regular basis.
- Use heat-resistant barbecue mitts or gloves when operating barbecue.

WARNING:

DO NOT transport your "Country Smoker" while operating or while the grill is HOT. Make sure the fire is completely out and that the grill is completely "Cool to the Touch"

- DO NOT use your grill in the rain or around any water source.
- Keep the back side of the grill a minimum 12 inches, or a safe distance, from all combustibles.
- Always unplug the grill before performing any service or maintenance .
- If the Country Smoker is stored outside during the rainy season or seasons of high humidity, care should be taken to insure that water does not get into the pellet hopper. Wood pellets, when wet or exposed to high humidity, expand greatly, break apart, and could jam the feed system.

It is a highly recommended practice to always go through the basic SET-UP Procedures after every 1 to 2 cookings. This will ensure proper ignition, heat output and many happy grilling experiences.



Savor the Flavor!

**COUNTRY
SMOKERS**
SMOKIN' GRILLS

Unpacking Your Country Smoker

IMPORTANT NOTICE

Be sure to inspect the entire grill after removing the protective shipping carton.
Report any damage to your local dealer immediately.
Shipping damage is not covered under warranty.



When you open your smoker/grill, please ensure you have and can identify all the following parts:

NOTE: Numbers following parts names throughout this manual refer to the component diagram below.

Items found in the box

- Burn Pot
- Burn Grate
- Arched Flavor Guard
- Series 3 Hopper w / igniter
- Optional Grease Bucket
- Handle Assembly
 - Bakelite handles X 2
 - Locking Washers X 2
 - Locking Nuts X 2
 - "L" shaped Bracket
 - Stainless Steel Handle
- Porcelain Cooking Grid (s)

Items found in the parts bag

- Wheels and levelers
 - 4" Diameter Wheels X 2
 - Wheel Axles X 2
 - #3 Hitch Pins X 2
 - Fender Washers X 2
 - Leg Levelers X 2
- Mounting Hardware—Hopper to Barrel
 - #10 x 16 x 1/2 Drip Screws x 6
 - mounting igniter and hopper to barrel
 - 1/4" x 20-1/2" Hex Screws—Self tapping x 2
 - mounting lower hopper to barrel

LG Hood thermometer

Printed Material

- Owners Manual
- Cooking Guide—40 page
- Tech Support Page

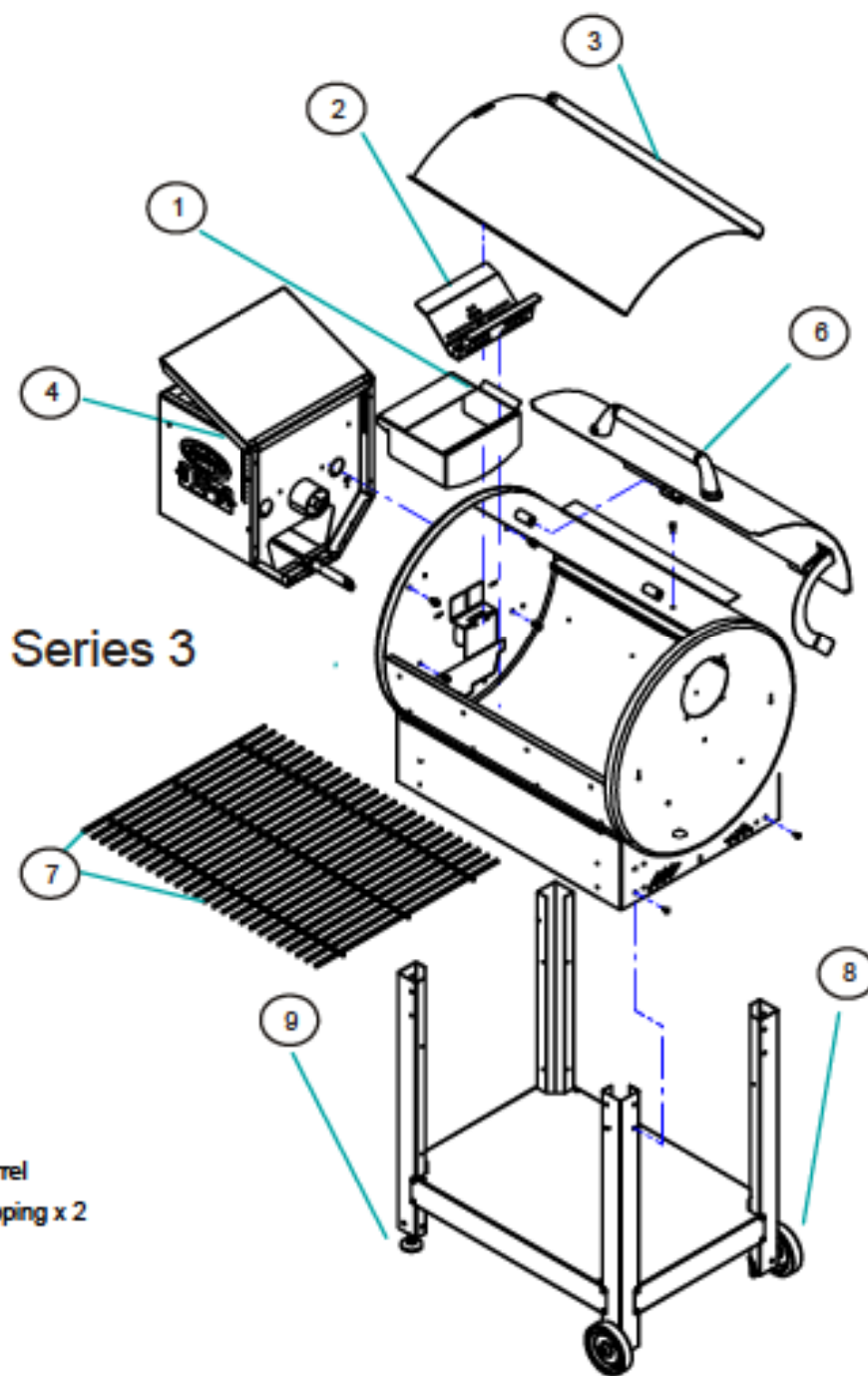

Series 3

COUNTRY SMOKERS
SMOKIN' GRILLS

Assembly Instruction

INSTALLING THE WHEELS & LEVELERS

Parts Included:

2 Screw-On
Leg Levelers



2 Wheel Assemblies
wheel, axle,
fender washer,
and #3 hitch pin clip

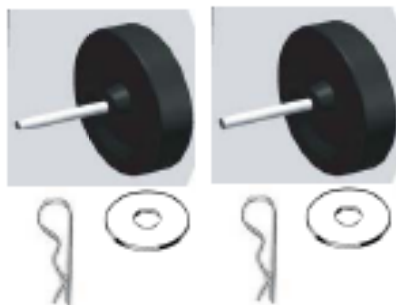

Tools Required:

None

Installation Steps:

Step 1 Remove unit from crating

Inspect entire grill.

Report any damage to your local dealer immediately.

Shipping damage is not covered under warranty.

Step 2 Prepare to Install:

- * Using the cardboard carton the unit was shipped in, to protect the finish of the unit, gently tip the unit on to its back.

Step 3 Install leg levelers: (diagram B)

The bottom portion of each leg has a plate installed to allow for the leg leveler (diagram B)

- * Install the levelers on legs 1 & 2 (diagram A)
- * Turn each of the leg levelers in a clockwise direction into the bottom leg plate. Turn approximately 1/2 of the way in.

Step 4 Install wheel assemblies: (diagram C)

- * Install the wheel assemblies on legs 3 & 4 (diagram A)
- * Insert axle through the leg assembly.
The wheel should be on the outside edge of the assembly, next the fender washer, then the leg assembly.
- * Insert the Hitch Pin Clip through the hole found at the end of the axle.

Step 5 Final Check:

- * Carefully lift barrel and leg assembly to the upright position.
- * Adjust the leg levelers, as needed, to ensure a level and sturdy grill.

(A)



(B)



(C)

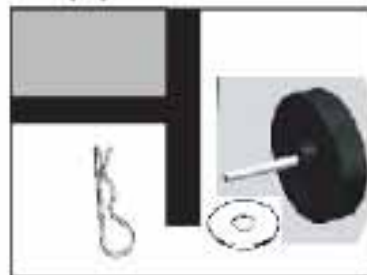

Assembly Instruction

INSTALLING THE HOPPER & IGNITER

Parts Included:

Series 3 Hopper Assembly
Mounting hardware

Tools Required:



Phillips & Standard Screwdrivers



1/4" Hex Nut Driver &
5/16" Hex Nut Driver



Installation:

Step 1 Protecting the Igniter :

- Carefully remove the tape holding the igniter to the rear panel of the hopper. **Diagram A**
- Place Igniter inside the hopper, through the large air opening. This allows for easy installation of the hopper to the barrel, as well as protects the igniter from damage. **Diagram B**

Step 2 Attaching the hopper to the barrel:

- Carefully lift the entire hopper to the left hand side of the main barrel. **Diagram C**
- The mounting bracket on the rear of the hopper (D) must be raised slightly higher then the receiving bracket on the barrel.(C) **Diagram C & D**
- Push the top of the hopper tightly against the main barrel, while keeping the bottom away. This stops the auger feed from scratching the powder coat.
- Next holding the hopper fairly level, press downward to clip the hopper lip (D) onto the mounting bracket. (C) Then the bottom should fit tight against the barrel.
- Using your 1/4" nut driver, electric drill and 4 of the #10 x 16 x 1/2" dritap screws secure hopper to barrel through the holes provided. **Diagram E**

NOTE: If the holes do not line up, the hopper may need to be fully clipped into place.

..... Con't



A



B



C



D



E



Assembly Instructions

Installation: ... Con't

Step 3 Installing the Igniter :

- Carefully remove the igniter from within the hopper to the inside of The cooking barrel
- Using your 1/4" nut driver and the 2 (two) remaining #10 x 16 x 1/2" Drip screws, secure the Igniter to the inside of the barrel. Diagram E

E



Step 4 Complete attaching the hopper to the barrel:

- Using your 5/16" nut driver and the 2 (two) larger 1/4" x 20—1/2" Hex screws, finish securing the hopper to the inside of the barrel. Diagram F

F

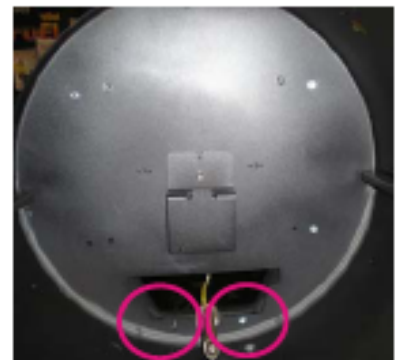

POSITIONING THE BURN POT AND BURN GRATE:

- Remove any debris from the bottom of the barrel. This reduces the possibility of air leaking around the bottom edges or the burn pot.
- To aid in cleaning you may wish to line the bottom of the barrel using heavy-duty aluminum foil.
- Install the Burn Pot (1), ensuring that the notched portion is pushed tight, into the hopper and against the side wall of the grill. The Pot will hook to the barrel end.
- Install the Burn Grate (2). The larger lip of the grate installs under the pellet drop chute. The end of the igniter should be exposed through the slot in the bottom side of grate. The grate should be a snug fit.

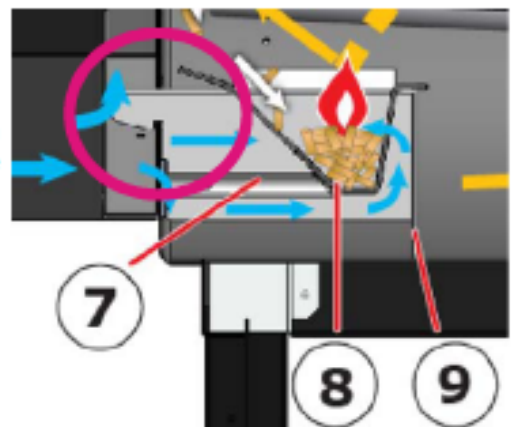
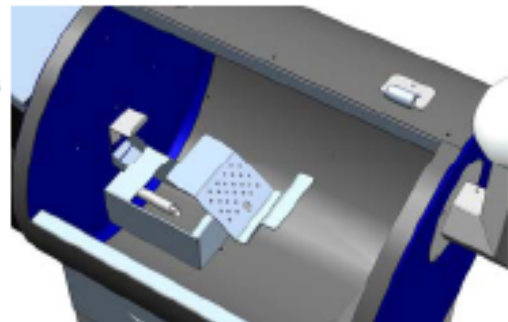

Assembly Instructions

POSITIONING THE BURN POT AND BURN GRATE ... con't

NOTE:

It is extremely important to have the igniter and the igniter hole in the burn grate line-up.

It may be necessary to remove the burn grate, then gently holding onto the igniter assembly, gently lift or lower the igniter till it lines up properly.



INSTALLING AND COVERING THE "ARCHED FLAVOR GUARD":

- To ensure proper height, the bottom of the mounting bracket (B) should not be within the pellet drop chute area. If you do need to adjust the bracket, loosen off the 2(two) phillips screws, lift the bracket and re-tighten the screws.
- To aid in cleaning you may take heavy-duty aluminum foil and line your Arched Flavor Plate (A). Using a right to left motion, cover the plate with a sheet of foil long enough to wrap up and under each end of the plate. Ensure the foil is snug against the angled edges of the plate.
- Take the Arched Flavor plate and hold it so that the end with the cut out is in your left hand. The plate then clips easily over the adjustable mounting bracket.

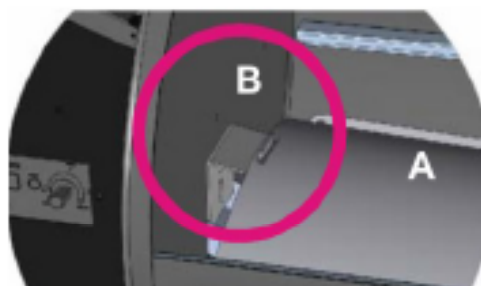

INSTALLING THE HANDLE:

Tools Required:



Installation:

- Insert one Bakelite (black plastic) bracket, bolt end, through the hole provide in the barrel hood.
- Insert the bolt end through the drip angle bracket and 1of the lock washers, to the inside of the barrel hood. Hand thread and tighten on 1(one) Hex Flange Nuts.
- Install the stainless steel handle onto the Bakelite bracket. Following the same procedure to secure the other Bakelite end of the handle to the barrel.
- Using a 7/16" wrench firmly tighten both nuts (12), till handle feels firm.

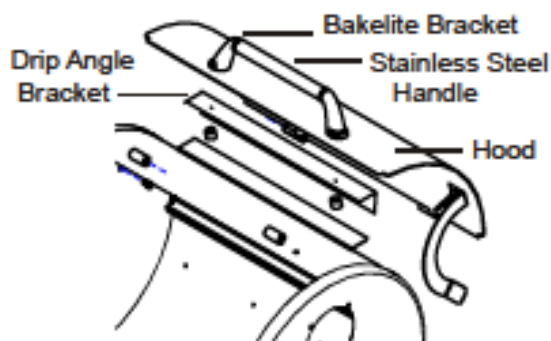

CAUTION! DO NOT OVERTIGHTEN! Only a snug fit is required.



Assembly Instructions

INSTALLING THE PORCELAIN GRIDS:

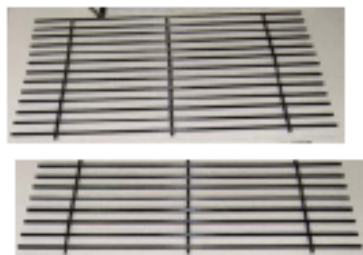

- Your Country Smoker comes complete with 2 Porcelain Grids
- NOTE: To maintain the searing and grilling performance of your grid, as well as their longevity, some special care and maintenance is required.

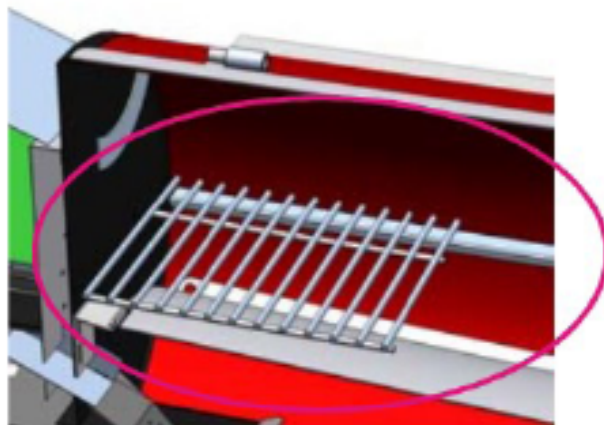

INSTALLING THE THERMOMETER:



Installation:

- The thermometer comes complete with its own threaded nut already installed on the thermometer.
- Simply spin off the threaded nut, and insert the thermometer through the hole provided in the top of the hood, Then firmly hand tighten the nut back onto the thermometer.

INSTALLING THE GREASE BUCKET:

- Simply place the handle of the bucket into the slot of the grease drop chute (11).

NOTE: any metal bucket and any size can be used. Ensure that the handle can safely clip into the slotted grease drop.



Knowledge is Power

How Your Country Smoker Works 101

- The perfect barbecue experience starts with filling your hopper (2) with all natural wood pellets.
- Click the "Power Switch" to the "ON" position (18), this activates the "Fan" (6) which is used to cool the hopper (2). Cause the pellets to burn (8) and results in convection cooking (14).
- Pushing the "Start" touch pad activates the electronic Auto Igniter (7), and the pellet feed system (3,5).
- A motorized Auger Motor (5) and Metal Auger Shaft (3), deliver the pellets to the burn grate (8). Your Country Smoker uses "Top Feed" technology, which means the Auger (3,5) delivers the pellets up above the burn grate (8) and then the fuel drops into the burn grate. The strength of the auger motor (5), the metal shaft (3) and the open design reduce the possibilities of "jams" and allows for the use of less than premium quality fuel.
- Adjusting the "Temperature Control Switch" on the Control Board (17) sets the speed of the feed, thus the temperature output. This control has no presets and is fully adjustable, from hot smoke to searing.
- The "Electronic Auto Igniter (7) activates for 7 minutes, igniting the pellets in the burn grate (8).
- The Combustion / Cooling fan (6) cools the hopper (16); provides combustion air to the burn grate (8); and causes air movement in the cooking area (14), resulting in convection cooking.
- The fuel burns in the burn grate (8) hot and intense, somewhat like a forge. The fly ash is directed downward by the "Arched Flavor Guard" (12) and can be cleaned out periodically from inside the bottom of the barrel.
- The "Arched Flavor Guard" (12) protects the food from direct contact with the flame; gives a large hot metal area to help evaporate the juices back into the cooking resulting in added flavor; channels excess grease directly to a grease pail (11); and distributes the heat evenly throughout the cooking area.
- The natural smoke flavor produced by the burning pellets, the "Arched Flavor Guard" (12) and the Convection Cooking (14) combine to give you the savory flavor that is unique to pellet grills and will win you rave reviews each time you use it.

TIP Your Country Smoker Grill can run efficiently over extended periods of time and at different heat output levels, as long as the fuel supply is uninterrupted and timely cleaning and maintenance is performed.



Series 3 Pellet Smokers/Grills

STANDARD FEATURES

- Powder Coat Finish NEW!**
1. Hopper Lid
 2. 12lb. Hopper **NEW!**
 3. Metal Auger Feed **NEW!**
 4. Stay Cool Handle
 5. Feed Motor
 6. Combustion / Cooling Fan
 7. 300 Watt Electric Igniter
 8. Stainless Burn Grate **NEW!**
 9. Locking Burn Pot **NEW!**
 10. Engineered Legs
 11. Grease Bucket **NEW!**
 12. "Arched Flavor Guard"
 13. Porcelain Cooking Grids
 14. Convection Cooking Chamber
 15. Dome Thermometer
 16. Air Cooled Vented Hopper
 17. Convection Air Exhaust
 18. "Louisiana Grills" Control
 19. Bottom Shelf
 20. Wheels
 21. Leveling Legs

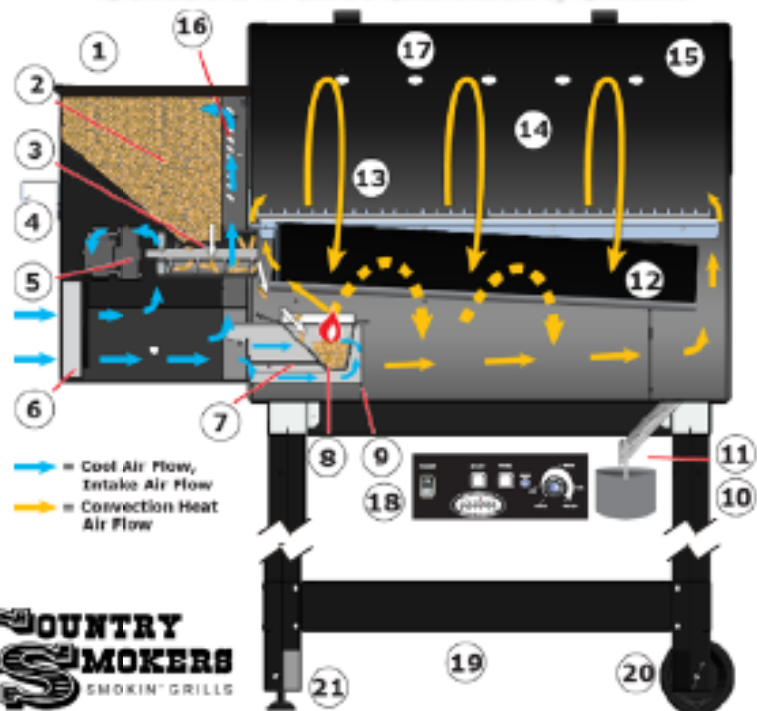

COUNTRY SMOKERS
SMOKIN' GRILLS

Knowledge is Power

Your New 420, 450, 570, 680 Wood Pellet Fired Smokin Grills

Large 12lb. Hopper capacity
Easy flip up top

Powder Coat Finish

Dome Thermometer

Time proven **Metal Auger
Feed System**

Fan Forced Combustion,
Cooling and
Convection Cooking.

Auto Start Button and Electric
Igniter eliminates the need for
matches & starter fluids.

Full Range Temperature Control
180 to 600 degrees, giving more
cooking options; hot smoking to
searing.

Primer Button aids in
quicker heat recovery or
increasing smoke intensity.



Leveling Legs

Easy move wheels

450, 570, 680
14 Gauge Steel Construction

420
16 Gauge Steel Construction
14 Gauge Steel Hood

Stainless Steel Stay Cool
Handle

Heavy-duty engineered
Legs and Shelf frame

| MODEL | COOKING AREA | ELECTRIC | SIZE H X W X D | WEIGHT |
|------------|------------------------|--|----------------|-----------|
| 420 | 420 sq. inches—primary | 110 Volt 60Hz 5 Amp 3 prong grounded plug 10 amp GFI | 43 x 37 x 23 | 109 lbs.. |
| 450 | 450 sq. inches—primary | Same | 43 x 39.5 x 23 | 111 lbs. |
| 570 | 570 sq. inches—primary | Same | 43 x 45 x 23 | 128 lbs. |
| 680 | 680 sq. inches—primary | Same | 43 x 51 x 23 | 132 lbs. |

OPTIONS

Clip-on Side Shelf

13" W x 18" D
Porcelain Grid with Powder
Coats brackets

Hopper Extension

Easy add-on w/ lid
Adds extra 20 lbs.

Custom Cover

Embroidered, heavy duty 600 denier,
polyester canvas, double stitched, UV
protected, Polyurethane interior,
Tighting strap.

Clip-on Front Shelf

8" deep
Porcelain Grid with Powder
Coat brackets

Digi Que

Digital Oven Control
with probe

Cabinet Enclosure Kit

2 swing open doors
2 side panels
1 rear panel
Stainless Steel or
Powder Coat Finish



Knowledge is Power

Arched Flavor Guard

All Country Smoker models come with a 14 gauge "Arched Flavor Guard", designed to withstand high temperature and give years of performance. The Arched Flavor Guard has been designed to keep the flame out of direct contact with your cooking surface, thus helping to reduce the chance of flare-ups. The arched design increases the amount of hot surface area to allow more fats and juices from the meats to evaporate as smoke flavor, back into meat. As well you will note the bent edges running down the length of the back and front of the angled, arched steel, these are to help in channeling the excess grease directly to the one end of the smoker where it is then allowed to collect in a convenient removable pail. The unique design also directs the majority of fly ash down



Automatic Igniter (#7)

The 300 watt electric igniter eliminates the need for messy starter fluids or gels. It is safe and easy to start, even the little beginner "Pit Master" can start a Country Smoker. The igniter is simply a hot rod encased in a stainless steel holder. This style of igniter has been used throughout the pellet stove industry for years. The combustion/cooling fan blows air into the back of the igniter assembly, surrounding the hot rod. Then the super heated air is allow exit through the open end, near the back of the burn grate. As the pellets begin to heat up they eventually break out in flames, this is know as spontaneous combustion. The igniter will stay activated for 7 minutes. If for any reason the igniter fails, you can start the grill manually.



NOTE: The igniter can be disconnected, to allow your country smoker to run with a minimum 75 watt inverter. (see manual starting procedures, further in this manual.)

Burn Grate (#8)

The burn grate is constructed out of stainless steel and is the heart of your grill. The burning temperature in the grate can reach temperatures of 1700 to 2000°F. The air holes are designed to allow the right combination of fan forced air to force the wood pellets to burn hot and clean while grilling or all them to smoulder and produce the savory smoke while in the smoke mode. The back of the burn grate has a large oblong hole in the back to allow the hot igniter air to come through, causing the pellets to catch fire.

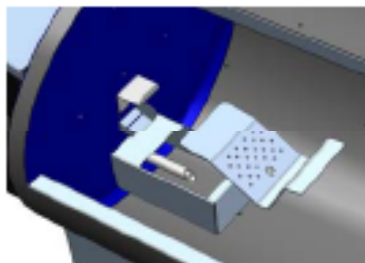

NOTE: The burn grate should be checked after every MAJOR use to ensure that the combustion air holes are not clogged and to ensure the igniter holes are clean.

Burn Pot (#9)

The burn pot is used to hold the Burn Grate, the igniter assembly and to channel the fan forced combustion air. The pot has been designed to be moved easily to aid in cleaning and replacement of the igniter. It is very important that the burn pot is seated properly in order to ensure proper combustion and heat output. The burn pot needs to be pushed in tightly against the side of the barrel, and locked into place. (see diagram).

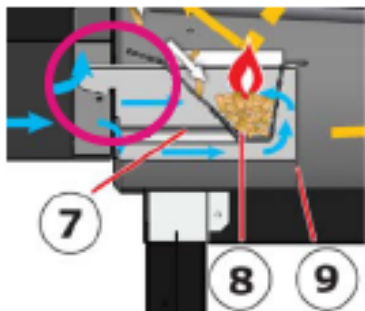

Ensure that there is no foreign matter under the burn pot that may lift it off the bottom of the barrel. This will allow combustion air to leak out, thus reducing the heat output of

Auger Feed System

The heart of the feed system is a time proven, metal auger (4) and high torque auger motor (5). This combination allows for different quality of pellet fuels to be used while reducing the possibilities of "jams" taking place. The metal auger design also helps in maintaining a constant and even feed of the fuel to the fire, resulting in better and consistent temperature control. The Auger Feed System is run by a 2 rpm motor and is timed to operate for 3 seconds. (see control board for further information).

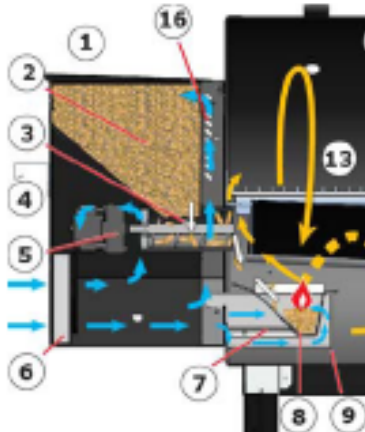

Knowledge is Power



Louisiana Grills Standard Control Panel Board Features

Power Switch

Used to turn both the power "ON" and the combustion / cooling fan on. Also activates The "Shut Down" mode of the grill.

START Touch Pad

Used to activate the "Start Up" mode. The metal auger feed system will begin to operate, the Power LED will illuminate blue, and the Auto Igniter will begin to glow.

PRIME Touch Pad

When this is pressed and held, the Fuel Feed System will turn and feed more pellets to the burn grate. This can be used to add more fuel just before opening the grill lid, to help with quicker heat recovery. It can also be used to add more fuel while smoking, to increase the smoke intensity.

POWER LED

Will illuminate blue when the Power Switch is "ON" and the "Start" touch pad has been pushed. It will continue to illuminate until the Power switch has been pushed OFF and the board has completed the automatic 15 minute "Shut Down" mode.

FEED POTENTIOMETER or Temperature Control

Used to control the frequency the Auger System feeds pellets to the burn grate, thus effecting the heat and smoke output. The Feed Potentiometer is NOT active when the grill is in the 7 minute "Start Up" mode, giving you the ability to set it at the PREHEAT setting while ensuring proper ignition. The temperature has no presets and is fully adjustable, allowing for changing weather conditions, different fuels, etc.

How the Board Works 101

START UP mode

Push the Power Switch to the ON position; set the FEED POTENTIOMETER to the PREHEAT position; then press the START touch pad, this activated the Automatic Start Up mode. This is a software set program that will automatically start the combustion/cooling fan, the igniter and run the feed system at a preset rate, for 7 minutes. After the 7 minute time, the temperature control will control the feed system. This feature gives you the ability to set the control at PREHEAT, turn the grill on, and go inside to prep your meal. This ensures proper ignition and then allows the grill to preheat properly, to clean and prepare for the next party stopper.

OPERATING mode

After the Start Up mode is complete, the Feed Potentiometer is fully functional. The auger feed system is designed to feed fuel for 3 seconds then stop feeding at preset times managed through the potentiometer. The "OFF" times range from 35 seconds for SMOKE to 3 seconds for PRHEAT. Because the all natural wood pellets fuel is dry and consistent, it is easy to keep a close to constant temperature.

NOTE: Keep in mind that all Louisiana Wood Pellet Grills are designed to operate with the lid closed and that the external temperatures, wind, rain and humidity will effect cooking times and heat output.

SHUT DOWN mode

When finished "Savoring the Flavor", simply push the Power Switch to the OFF position. The control will begin a 15 minute cool down cycle. The feed system will stop delivering fuel, but the combustion / cooling fans will continue to run in order to burn out the pellets clean and efficiently, and to properly cool all the component parts. After the 15 minute mark, everything will shut down and the blue LED light will go OFF. If you do find more food to grill or bake, you can turn the Power switch to the ON position within the first 3 minutes and the grill will continue to operate as normal. If you miss the 3 minute window, you must go through the START UP mode again.



Knowledge is Power

Fan Cooled Hopper

The entire line of Country Smokers utilize the exact same hopper and component parts. To increase the life of your grill and its main working component parts the Combustion / Cooling fan is used to perform 3 main functions:

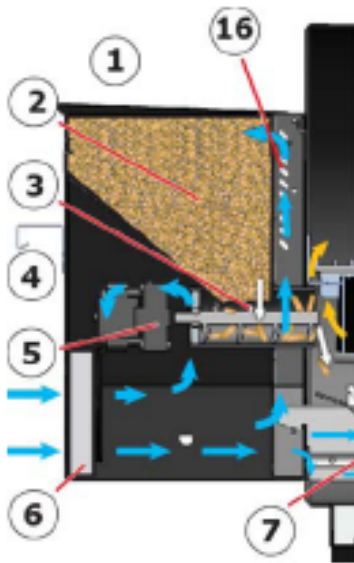

1. Pressurize the internal hopper compartment to cool the wiring, electrical component parts and the wood pellets.
2. Forces constant air movement between the hopper and the grill barrel wall. Because of higher temperatures needed for searing and because of the longer length of time a pellet grill can operate, eg. Slow smoking a whole hog, air movement is used to provide an air barrier between the two surfaces. Ensure the air slots found on the front and back of the hopper do not get blocked off, at any time.
3. To provide combustion air, allowing the pellet fuel to burn properly. The fan forced air is then used to provide "Convection Cooking" within the smoking grill. Convection cooking locks in the juices and distributes the heat evenly throughout the grill resulting in that savory flavor and near perfect cooking.



Powder Coat Finish

Louisiana Grills uses a "High Heat Powder Coat" finish throughout the entire line of the Country Smokers. This is done to allow for easy and trouble free maintenance, and adding to the life of your smoking grill. Powder coating is environmental friendly and produces an excellence and superiority of finish that customers count on. Maintaining the initial appearance of a powder coating is a simple matter.

(see maintenance for further detail)

Porcelain Coated Cooking Grids

Your Country Smoker Grill comes complete with porcelain coated cooking grills or grids, as they are called by the "Pit Masters". Porcelain grids do not have the same heat retention as cast iron, but they do show "steak house grid marks", and are very easy to clean. To maintain the searing and grilling performance of your grid, as well as their longevity, some special care and maintenance is required.

(see maintenance for further detail)



Grease Catcher

All Country Smokers use the "Arched Flavor Guard" system that channels any excess grease, that does not evaporate, directly to a sealed grease catch area. From here any excess grease is directed to the drop spout where it is disposed in an easy to clean or replace metal bucket. The metal handle of the bucket simply hooks on the notched out groove of the grease spout. Allow the grease to cool before removing the pail.

TIP: if you want to replace your grease fill bucket with a new one, save any small buckets that you acquire from yard candles, etc.

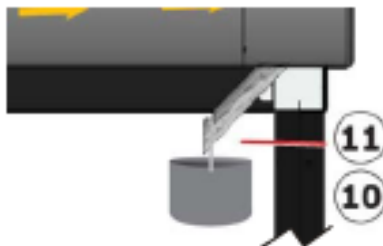

Knowledge is Power

About Wood Pellets



They are no thicker than the eraser on the end of a pencil, people who see them for the first time think they look like rabbit food, but there is nothing small about the heat energy in a wood pellet. These clean burning wood pellets generate about 8200 BTU's per pound with very little ash and low moisture content.

Barbeque wood pellets are produced in the same manner as wood pellet fuel is produced for home heating. Pure raw material (sawdust) is pulverized with a hammer-mill and the material is pushed through a die with pressure over 3 000 PSI. As the pellet is forced through the die it is sheared off at a specific maximum length, cooled, screened, vacuumed, and then bagged into 20 lb bags.

General specifications for barbeque pellets are: 100% hardwood, with no additives or chemicals.

Mesquite, from the Aztec "mizquiti" (which means "the honey tree"); true to its name gives a delicate, subtle, sweet flavour to grilled foods- especially good with poultry and seafood.

Hickory intensifies the flavour of food with a robust, tangy taste that is better suited to red meat than to poultry and fish.

Apple or fruitwoods, many from orchards destroyed by fire or old age, are a big hit. Like its mesquite counterpart, the heaviest branches of the apple tree is heated to kill insects, then chipped, made into pellets, and packaged for retail. Apple or any fruitwood, adds a smoky, mild sweetness to everything that you cook or is highly recommended for any baking.

| | Beef | Buffalo | Lamb | Pork | Poultry | Fish | Vegetables | Baking |
|----------|------|---------|------|------|---------|------|------------|--------|
| Hickory | x | x | | x | x | | x | |
| Mesquite | x | x | | | x | x | x | |
| Alder | x | x | x | x | x | x | x | x |
| Apple | | | | x | x | | x | x |
| Cherry | x | x | x | x | x | | | x |
| Orange | | | | x | x | | | x |
| Pecan | x | x | x | x | x | x | x | x |
| Oak | x | x | x | | | x | | |
| Maple | x | x | x | x | x | x | x | x |
| Peach | | | | | x | | x | x |

Be brave, think outside the bag, try different varieties or mix them together to customize your blends.

TIP



Always store your pellets in a dry area. Avoid any contact or exposure to moisture. This will cause the pellets to absorb the moisture and will result in lower BTU output or the pellets to swell and break apart. Use a moisture proof re-sealable tub or bucket.

- Mesquite
- Hickory
- Alder
- Apple
- Cherry



COUNTRY SMOKERS
SMOKIN' GRILLS

Getting Started

Set Up Procedure

Please note that during shipping or moving around on your deck, some movement within the grill may have taken place, so a complete visual inspection is required. Please follow these Initial Set-Up procedures to ensure the proper and safe operation of your grill.

TIP It is a highly recommended practice to always go through these basic SET UP PROCEDURES, after every 1 to 3 cookings. This will ensure proper ignition, heat output and many continuous happy grilling experiences.



Step 1

Open the SMOKER LID and remove the Cooking Grids (13).

Step 2

Remove the "Arched Flavor Guard" (12). Clean off any excess food drippings or grease build-up.

Step 3

Remove the Stainless Steel Burn Grate (8) and Burn Pot (9). Remove any foreign items. Ensure that the air holes in the grate (8) and the igniter (7) are clear of debris.

Note: You can line the bottom of the barrel with heavy-duty aluminum foil. Line from left to right, starting under the igniter (burn pot area) and going to the Arched Flavor Guard support. This will make clean-up and general maintenance easier.

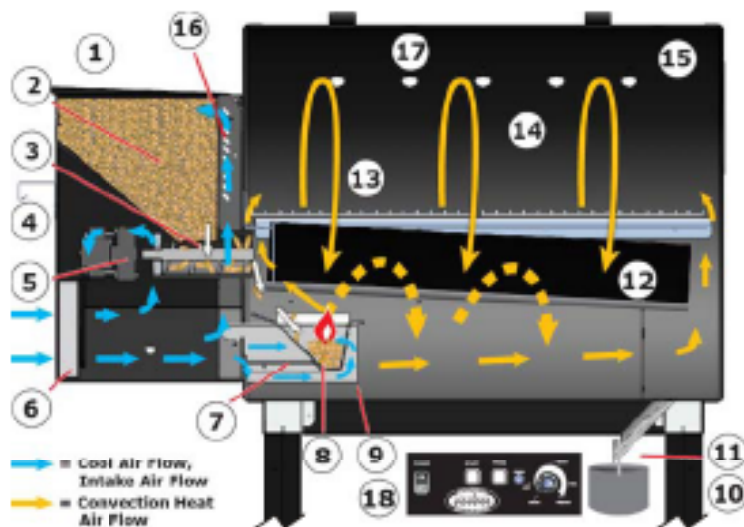

Step 4

Re-install the Burn Pot (9). Slide the Burn Pot all the way into the side of the barrel and hopper opening and ensure the pot clips into place. Confirm that the pot is setting snug to the barrel bottom.

Step 5

Re-install the Burn Grate (8). Ensure that the stainless steel grate is setting down and snug in the burn pot (9) and that the igniter is lined up properly with the hole in the burn grate. You may have to gently lift up or down on the igniter to align with the hole.

Step 6

Re-install the "Arched Flavor Guard" (12). The "Arch" should be facing upward and sets on a mounting bracket and grease divider plate. One end of the Arch does have a slot cut into it. This slot hooks over the moveable hanging bracket found over the pellet fuel drop area. Ensure that this mounting bracket is snug against the barrel. If you are cooking anything with a large amount of drippings, you may want to line the Arched Flavor Guard with heavy-duty aluminum foil.

Step 7

Re-install the Cooking Grids (13)

Step 8

Ensure the Grease Bucket (11) is installed, cleaned and ready to go.

Step 9

Open the Hopper Lid (1) and check for any foreign materials. Fill the hopper (2) with your choice of all natural wood pellet fuel.

Step 10

Plug it in. Start it up. Savor the Flavor!



Getting Started

With today's lifestyle of striving to eat healthy and nutritious foods, one factor to consider is the importance of reducing fat intake. One of the best ways to cut down on fat in your diet is to use a low fat method of cooking, such as grilling. Because a pellet grill uses natural wood pellets, the savory wood flavor is cooked into the meats, thus reducing the need for high sugar content sauces.

Throughout this manual you will notice the emphasis on grilling food slowly at MEDIUM temperature settings. Because of the benefit of convection cooking and the use of the "Arched Flavor Guard", your country smoker will enable you avoid flare-ups and maximize the nutritional value of the foods that you cook.

Following is a list of the important tips that will contribute to the cooking perfection that you expect when using your Country Smoker.



Environment

As with all barbecues, the outside weather conditions will play a big part in the performance of your Country Smoker and the cooking time needed to perfect your culinary delights. Your Country Smoker, because of its single wall construction, should be considered as a 2 to 3 season grill, depending on what part of the country you live in. For greater detail on grilling and weather conditions, see the "HOT and COLD" weather tips found in your Louisiana Grills Cook Book and Recipe Keeper.

Grill Placement

All Country Smokers should always be a minimum of 12 inches away from any wall behind the grill. Your grill does come with wheels or casters to make movement easier. If you are able to shelter your smoker from the wind, this will aid in temperature output, heat retention, and heat recovery time when opening the lid. Turning the smoker a 1/4 turn, keeping the smoke vent holes out the wind, will result in better temperature output.

Operating the Grill

Initial Burn Off

Before cooking on your smoker / grill for the first time, we recommend that you "Burn Off" the grill to rid it of any foreign matter. Light and operate the grill on PREHEAT, with the lid down, for 30—40 minutes.

Lighting your Grill

It is recommended practice to always go through the SET UP Procedures after every 1 to 3 uses. This will ensure proper ignition and many happy grilling experiences. Light as per instructions, found in this manual. If the grill fails to light, this is most likely due to a dirty or full burn grate blocking the auto igniter air passages. (refer to lighting instructions found elsewhere in this manual).

Should your auto igniter refuse to ignite the wood pellets, it is easy to light your grill manually with a match and lighting agent. (refer to manual lighting instructions found elsewhere in this manual).

Pre-Heating

It is extremely important to **ALWAYS** allow your grill to preheat, reach temperatures over 500°F for over 5 to 10 minutes, before cooking, each and every time. This allows the grill and cooking grids to heat up quicker; it burns off any bacteria or foreign material left over; and grill is able to maintain its cooking temperature once your food is placed in the cooking area. When you do not take the time to PREHEAT, you will find that it takes a much longer period of time to bring both the grill and food to cooking temperature.

Always PREHEAT your country smoker with the lid closed. Set your temperature control to PREHEAT, start your grill, and allow your grill to PREHEAT for 5 to 10 minutes. This gives you plenty of time to prepare your food for the grill, as well it is the final step in cleaning your cooking grids.

Lid Position

Always cook with the lid closed. Not only does this keep the temperature even, the food will cook faster, while using less fuel. A closed lid also helps to create a smokier flavor. You can slow down your cooking by propping up the lid using a grid lifter.

CAUTION: Grease fires are caused by not properly maintaining your grill, or failing to clean the bottom of the barrel on a consistent basis. In the unlikely event you experience a grease fire while cooking, quickly remove any food items, then close the lid. If it does not go out in a very short time, open the lid and lightly sprinkle baking soda on the fire. Be careful not to burn yourself. If this does not work, then turn OFF the control board, to stop the pellets from feeding, and shut the lid until the fire is completely out.



Getting Started

Following is a list of the important tips that will contribute to the cooking perfection that you expect when using your Country Smoker.



NOTE: The temperature markings on the control board are NOT accurate! Due to environment, fuel, and cooking conditions, the settings are only for reference!

Operating the Grill ... con't

Cooking Settings

PRE HEAT

The PREHEAT setting will give an oven temperature of over 500 to 600°F (316°C), depending on the weather. This setting is used to quickly preheat your grill as well as to finish the cleaning cycles for the cooking grids and the "Arched Flavor Guard" could also be used as a HIGH setting in extreme cold weather conditions or if cooking with the lid open.

HIGH / MEDIUM / LOW

As you turn the Temperature Control counter close the temperature output will decrease. Turn the knob to what you think may be your desired temperature, let the grill react for 5 to minutes, then adjust as you need.

SMOKE

The SMOKE setting will give an approximate oven temperature of 180 to 220°F. This setting is used to slow roast; to increase the smoke flavor; to keep foods warm; and many other savory things. Highly recommended for the BIG BIRD at Thanksgiving, Easter ham, or that huge Christmas feast.

Smoking is a variation on true barbecuing and is truly the main advantage of grilling on a wood pellet grill. There are two types of smoking: HOT SMOKING and COLD SMOKING. HOT smoking, just another name for barbecuing is generally done at 180 to 250°F. HOT smoking works best when a longer cooking time is required, such as large cuts of meats, fish, or poultry. COLD smoking is where the food is located so far away from the fire that it smokes without cooking. Your Country Smoker is classified as a HOT smoker.

Experiment with the length of time you leave for smoking, before cooking thoroughly. Some chefs, or Pit Masters as the barbecue world call them, prefer to smoke at the end of cooking and to keep the food warm until ready for serving. Remember PRACTISE MAKES PERFECT.



TIP The temperatures listed above are all approximate and will be affected by the outside temperature, the amount and direction of wind present, the length and type of pellet fuel being used and the number of times the lid opened.



After Cooking - "Cleaning Up"

One of the greatest benefits of your Country Smoker is the minimal clean up required. When you are finished cooking and waiting just a little while to let the flavor set in that prime selection of meat, we recommend the following:

1. Using a long handle grill cleaning brush, brass or soft metal, to remove any food or build-up from the cooking grids, while it is still warm.
2. Turn the temperature control to PREHEAT for 5 minutes. Let the grill heat up, then push the POWER button to the "OFF" position and your done.
- The control will stop feeding pellets, but the fan will continue to burn them properly, till they burn out, and then the unit will shut down automatically in 20 minutes.
3. A quick wipe up of the powder coat surfaces, using a cloth, warm water and mild soap, will keep the unit looking like new.
4. Let the smoker cool and put your Country Smoker to bed with the optional GRILL COVER.

TIP To intensify that savory flavor, switch to smoke mode immediately after putting your food on the grill. This allows the smoke to penetrate the meats before the pores in the meat close at 120°F.



Getting Started

Lighting Your Country Smoker



TIP It is a highly recommended practice to always go through these basic SET UP PROCEDURES, after every 1 to 3 cookings. This will ensure proper ignition, heat output and many continuous happy grilling experiences.

Automatic Start Up

1. Ensure the POWER switch is in the "OFF" position.
2. Plug the POWER CORD into a 110Volt grounded outlet. DO NOT break the ground end off the cord or use a non-grounded outlet or extension cord.
NOTE: When plugged into a GFI ensure it is good for at least 10 amps.
Lower GFIs may trip when using this appliance.
3. Open the HOPPER LID. Ensure there are no foreign objects in the hopper or feed system. Fill the hopper with only all natural flavored wood pellets.
4. Turn the FEED CONTROL (temperature output) to the PREHEAT position.
5. Switch the POWER switch to the "ON" position.
This will start the Combustion / Cooling fan.
6. Press the START touch pad.
This initiates the automatic START UP cycle, which includes:
The FEED SYSTEM will start to turn at a set rate for 7 minutes, then it will turn
At the rate the Temperature control is set at.
The IGNITER will begin to glow
And the POWER indicator will illuminate.
Your smoker will begin to produce smoke while the START UP cycle is taking place, In approximately 3 to 5 minutes. Close the lid.
The pellets have ignited once the smoke has cleared. To check, open the lid of your smoker and a flame should be visible in the burn pot area. You will be able to view this without having to touch any hot surfaces.
7. Turn the Temperature Control to PREHEAT, If not already, and allow the unit to preheat to approximately 15 to 20 minutes.
CAUTION: If excessive flame is visible i.e. "Arched Flavor Guard" is glowing bright red, turn the Temperature Control down.
8. After the PREHEAT is complete you are now ready to enjoy grilling experience.

NOTE: Different wood pellets will produce different temperatures; as well the outside temperature and weather conditions will also effect your cooking temperatures. Remember, the markings on the CONTROL LABEL are approximate.

TIP NEVER add pellets by hand to a hot fire. This is dangerous and you will get seriously burned. If you do run out of fuel and you loose your fire while cooking, re-fill the hopper, and go through the normal LIGHTING PROCEDURES.



NOTE: If the fire does not start, the Country Smoker will continue to feed pellets. If this happens, some unburned pellets will build-up in the burn grate. BEFORE restarting the fire, clean the excess pellets out of the burn grate and follow the above steps.



Getting Started

Lighting Your Country Smoker ... CONT

TIP It is a highly recommended practice to always go through these basic SET UP PROCEDURES, after every 1 to 3 cookings. This will ensure proper ignition, heat output and many continuous happy grilling experiences.



Manual Start Up

If for any reason your electric igniter fails, you can start your Country Smoker manually.

1. Ensure the POWER switch is in the "OFF" position.
2. Plug the POWER CORD into a 110Volt grounded outlet. DO NOT break the ground end off the cord or use a non-grounded outlet or extension cord.
NOTE: When plugged into a GFI ensure it is good for at least 10 amps.
Lower GFIs may trip when using this appliance.
3. Open the HOPPER LID. Ensure there are no foreign objects in the hopper or feed system. Fill the hopper with only all natural flavored wood pellets.
4. Remove the COOKING GRIDS and ARCHED FLAVOR GUARD to expose the BURN GRATE and BURN POT.
5. Place two (2) generous handfuls of pellets into the BURN GRATE.
6. Squirt gelled fire starter, or other approved pellet starter, over the top of the pellets. Sprinkle a few more pellets over the fire starter.
WARNING: NEVER ATTEMPT TO ADD MORE STARTER INTO A FIRE THAT IS ALREADY BURNING OR INTO A HOT BURN GRATE. YOU COULD EXPERIENCE A BURN BACK AND YOU COULD GET SERIOUSLY BURNT.
7. Light the starter using a long fireplace match or long butane lighter.
8. Allow the starter to burn for 3 to 5 minutes.
9. Quickly and carefully replace the ARCHED FLAVOR GUARD and the COOKING GRIDS.
10. Turn the TEMPERATURE CONTROL to the PREHEAT position.
11. Switch the POWER switch to the "ON" position.
This will start the Combustion / Cooling fan.
12. Press the START touch pad.
This initiates the automatic START UP cycle, which includes:
The FEED SYSTEM will start to turn at a set rate for 7 minutes, then it will turn
At the rate the Temperature control is set at.
The IGNITER will begin to glow
And the POWER indicator will illuminate.
Your smoker will begin to produce smoke while the START UP cycle is taking place, In approximately 3 to 5 minutes. Close the lid.
The pellets have ignited once the smoke has cleared. To check, open the lid of your smoker and a flame should be visible in the burn pot area. You will be able to view this without having to touch any hot surfaces.
13. Turn the Temperature Control to PREHEAT, If not already, and allow the unit to preheat to approximately 15 to 20 minutes.
CAUTION: If excessive flame is visible i.e. "Arched Flavor Guard" is glowing bright red, turn the Temperature Control down.
14. After the PREHEAT is complete you are now ready to enjoy grilling experience.

CAUTION: DO NOT USE ANY FLAMMABLE LIQUIDS SUCH AS GASOLINE, GASOLINE-TYPE LANTERN FUEL, KEROSENE, CHARCOAL LIGHTER FLUID, OR SIMILAR LIQUIDS TO START OR FRESHEN-UP THE FIRE! KEEP ALL SUCH LIQUIDS WELL AWAY FROM THE GRILL WHILE IT IS USE.



Getting Started

Shutting OFF Your Smoker

Your Country Smoker will give you many years of flavorful service with minimum cleaning. An important step is allowing the grill and cooking grids to "Self Clean" by running the grill on HIGH or PREHEAT temperatures for 5 to 10 minutes after each use.

When finished cooking on your Louisiana Grill turn the TEMPERATURE CONTROL to PREHEAT. Let your grill run for 5 to 15 minutes, depending on what you just cooked, to go through its normal cleaning method. If you are preparing meats that are extra greasy, such as anything in BACON, it is a good practice to allow the grill to burn off for an extra 10 to 20 minutes. You could experience a grease fire, but DO NOT PANIC, DO NOT UNPLUG the appliance, just leave the lid close and let the grill burn itself out naturally. Much like a self-cleaning oven. This will greatly reduce the chances of "Flare-Up" while you are preparing your next savory meal.

When cleaning is complete, simply push the POWER switch to the OFF position. Your Louisiana Grill Control will begin its automatic SHUT DOWN procedure.

- The FEED system will stop feeding fuel.
- The flame will burn itself out naturally.
- The combustion / cooling fan will continue to run for 15 minutes.
- When the procedure is complete the FAN and POWER LED will turn OFF.

If you did forget to grill desert, you can turn the POWER switch to the "ON" position within the first 3 minutes and the grill will continue to operate as normal. If you miss the 3 minute window, you must go through the START UP mode again.

Grill Maintenance

There are two extremes when it comes to keeping the grill clean. Those that must spit and shine the entire grill, in and out, after every use, and those whom are convinced that cleaning only takes away from that barbecue flavor.

One simple rule: EVERYTHING IN MODERATION !

TIP Be diligent in your cleaning and maintenance program. Taking care of your grill will add years of life to it and keeps it looking great!



STARTING THE SEASON OUT RIGHT

A little time and effort at the beginning of the season will not only help extend the life of your grill but will also ensure the reliability of it. Making you look like the "King or Queen of the Grill"! Most of the cleaning techniques are below. Check with your local dealer, they may provide a yearly maintenance program and inspection service.

STAINLESS STEEL WORKING SURFACES

ALWAYS clean dirt and dust off all stainless steel surfaces before you begin to cook. The dirt can cook into the metal and discolor it. These can be easily cleaned with hot soapy water and a soft cloth. A quick swipe of "Stainless Steel Cleaner" and a soft rag will also work, but you must be careful not apply it to the painted surfaces or interior parts. With the popularity of stainless steel appliances increasing, there are now many commercial products made to clean and protect stainless steel surfaces.

POWDER COAT SURFACES

Powder coat and maintaining powder coat surfaces are not covered under warranty. This is part of general maintenance and upkeep.

Be sure to cure your brand new Country Smoker for at least 30 to 40 minutes before using it for the first time. This allows the powder to cure properly and allows for that "NEW SMOKE SMELL" and manufacturing residue to be burned off.

Once installed, maintaining the initial appearance of a powder coating is a simple matter. The smoke and grime which builds up on surfaces from time to time contains moisture and salts which will adversely affect the powder coating and must be removed. Powder coatings should be washed down regularly. The coating should be washed down with soapy water – use a neutral detergent – and rinsed off with clean water.

When powder coated items are installed without damage to the powder coating and they are maintained regularly, they should be relatively permanent. The correctly applied coating, although not metallurgically bonded to the metal will not crack, chip or peel as with conventional paint films.



Grill Maintenance

....con't

COOKING GRIDS

When new, wash thoroughly with warm soapy water, place back in the smoker and PREHEAT the grill for 20 to 30 minutes. After the completion of grilling, open the lid and with a long handle grill cleaning brush give the grids a thorough cleaning. If you do not have a cleaning brush use long handle tongs and a balled up piece of aluminum foil wrap. Next turn the grill to "High" or "Preheat" until only an occasional wisp of smoke is seen (about 5 minutes). This will remove most of the material that builds up on the cooking grids.

The next time you grill allow the smoker to PREHEAT for 10 to 15 minutes to complete the cleaning cycle. Give the grids a quick wipe down with your cleaning brush. Applying a thin coating of cooking oil on the grids before placing your meat on them will also decrease your cleaning time, as well as allowing to move your food easily without sticking and tearing.

THE BIG COVER-UP

Your Country Smoker will help in protecting your grill from the detrimental effects of weather and outside pollutants. As with any outdoor product, however, a cover is only as good as the maintenance given to the grill. Following the recommended maintenance included in this manual will add greatly to the life of your grill.

Helpful Hints

DO's

- Keep your Country Smoker cover clean. This is your best protection against mildew which will form on any dirt or foreign material allowed to accumulate on tops or bottoms of fabric. Use a cleaner or product that will not only clean but will also protect.
- Have any small tears or punctures repaired promptly.
- Keep away from pets.
- Keep all shrubs and vines away from your grill cover as many plants contain acids, which warm fabrics.

DO NOT

- Cover your grill while the grill is still hot
- Store anything on the top of your grill cover.
- Permit leaves, twigs or other organic debris to remain on the cover for long periods of time.
- Use high-pressure hoses or steam to clean.
- Use wire or stiff brushes, harsh detergents, abrasive cleaners or chlorine on your grill cover.



ARCHED FLAVOR GUARD

This requires very little work, because of its construction and type of material used. From time to time you may need to brush off any burnt leftover, such as melted cheese or that extra thick bbq sauces. The best time to clean and inspect is when you perform the initial set-up procedures after every 1 to 3 uses.

To speed up cleaning we recommend that you line the Arched Flavor Guard with heavy-duty aluminum foil. This foil should be replaced after each use.

The grease channels do need to be cleaned from time to time to eliminate build-up and allow the grease to flow freely to the grease catch area.

THE COOKING BARREL

To start the season fresh, then maybe 2 to 3 times during the grilling season, it is recommended to remove the Arched Flavor Guard, Burn Grate and Burn Pot. Then give the entire interior a good cleaning, de-greasing and vacuum, to remove everything that may have accumulated.

- Ensure that the grill is COMPLETELY COLD before using your shop vacuum or before scooping out and disposing of the ashes.
- You may want to use soapy hot water, a kitchen de-greaser, etc. to clean the entire inside of the barrel. This does Reduce grease build-up and the possibilities of flare-ups.
- To aid in cleaning, it is recommended to line the bottom of the barrel with heavy duty aluminum foil. Start tight from burn side of the barrel and end at the grease stop area.



Grill Maintenance ... don't

SERIES 3 BURN POT NEW

The proper seating of the Burn Pot is crucial to proper grill performance. The Series 3 Burn Pot placement has a locking hook system built-in to help in keeping the proper placement. The main function of the Burn Pot is to channel the fan forced air into the Burn Grate, thus there is very little maintenance required. Occasionally you may either vacuum or brush out any ash build-up or burn debris that has fallen below the burn grate.

Before replacing the Burn Pot always clean any debris from around or under the Burn Pot seating area. It is crucial that the Burn Pot is seated tight to the barrel side wall, tight to the barrel bottom, and is hooked in place to ensure proper placement.

SERIES 3 STAINLESS STEEL BURN GRATE NEW

Periodically check the air holes found on the sides of the Burn Grate for any blockage or build-ups.

Using a wire brush or flat-head screwdriver, scrape off any build-up or debris. If there is extreme build-up blocking the holes, you may wish to drill the holes clean.

When re-installing the Grate confirm the proper seating in the burn pot. The grate is seating straight, igniter hole and igniter line up and there is little play from side to side in the burn pot.

SERIES 3 IGNITER NEW

The 300 watt electric igniter needs very little maintenance. Confirm that the igniter is free of debris or blockage. Also check the four (4) set screws securing the hot rod into the stainless steel casing are snug. The hot rod should be flush with the angled front end.

SERIES 3 FAN COOLED HOPPER ASSEMBLY NEW

ALWAYS DISCONNECT THE POWER TO YOUR GRILL BEFORE PERFORMING ANY SERVICE.

There are a number of very quick checks that should be performed on the OUTSIDE of the hopper assembly:

1. Check and clean any debris from the fan air intake. Eg. Spider webs, tree fluff, etc.
2. Check and clean any debris for the air vent exhaust, found on the front and back sides.
3. Inspect and clean the fuel hopper area. The galvanized metal can be wiped down using warm water and detergent. To aid in protecting the metal and to allow pellet fuel to slide easily, you can apply a coating of car wax.
4. Inspect the metal auger area. Check for sawdust build-up and for debris.

You can remove the 6 (six) screws securing the end panel to the hopper assembly. There are two on the front, two on the back, and two on the under side. This will allow you to perform the following within the hopper assembly:

1. Check and clean any debris within the hopper housing.
2. Check and clean any debris from the fan blades or housing.
3. Check and clean any debris from the Auger Motor
4. Visual inspection on the wire harness and all wire connections.

Upon inspection replace all screws. Hand start each screw to ensure proper threading.

GREASE CATCH AREA AND BUCKET NEW

Always be sure the grease catch area is clean and free of debris. During the warmer months empty any grease build-up on a more frequent basis to avoid it from going rancid and to avoid having any extra creatures enjoying your grill.

SLOWING DOWN . . . NOT PUTTING AWAY FOR THE SEASON

We recommend that at least once a month, while your grill is cold, that you should perform not only the above maintenance procedures, but also include the following.

1. Using a stiff vegetable brush knock-off any build-up scale on the inside walls of your grill. Check the inside of the lid, the Arched Flavor Guard, and the inside walls of the cooking area.
2. Using an old paintbrush, brush off any ash build-up found inside the firebox, grate and Arched Flavor Guard.
3. Give your entire grill a good cleaning with a shop vac, when cool to the touch, then quick wash and rinse.
4. Finally, visually inspect the powder coat finish. Touch up any scratches with the proper touch-up.



Wiring Diagram

RATING: 110volts AC, 3.1Amp, 60Hz
 ESTIMATION: 110volts AC, 3.1Amp, 60Hz

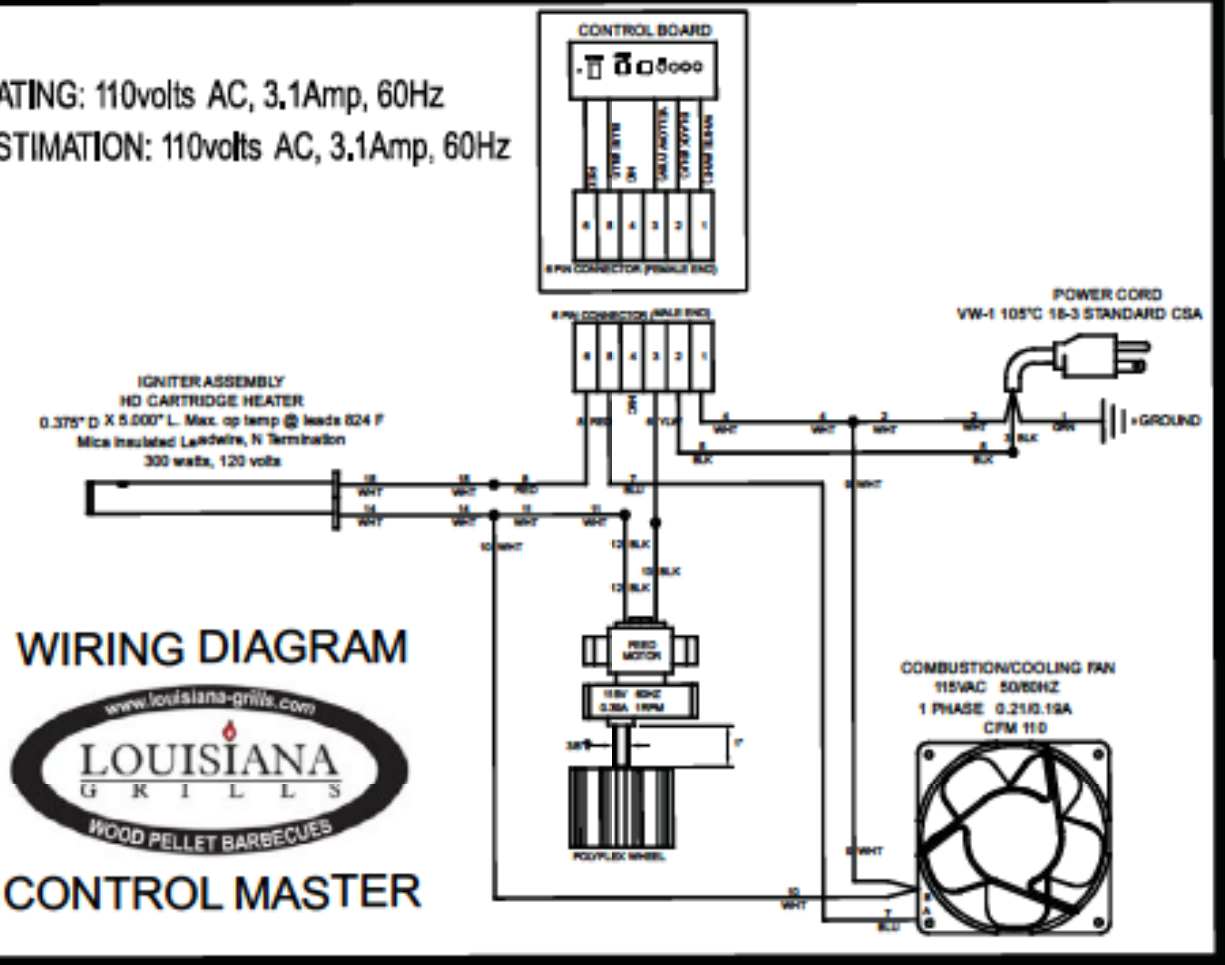

WIRING DIAGRAM

CONTROL MASTER



Limited Warranty

The "Country Smoker" wood pellet barbecue line, manufactured by Canadian Comfort Industries (CCI), carries a five (5) year limited warranty for from the date of sale to the original owner only, against defects and workmanship on all steel parts, (excluding the burn grate), and three (3) year on electrical components. There is no specific warranty on the paint, powder coat, burn grate, grill cover and all gaskets or against damage caused from corrosion.

Conditions of Limited Warranty

During the term of the limited warranty, CCI's obligation shall be limited to furnishing a replacement for covered, failed components, F.O.B. point of shipment. As long as it is within the warranty period, CCI will not charge for repair or replacement for parts returned, freight prepaid, if the part(s) are found by CCI to be defective upon examination. CCI shall not be liable for transportation charges, labour costs, or export duties. Except as provided in this CONDITIONS OF WARRANTY paragraph, repair or replacement of parts in the manner and for the period of time stipulated hereunder shall constitute the fulfillment of all direct and derivate liabilities and obligations from CCI to you.

The warranty coverage begins on the original date of purchase and proof of date of purchase, or copy of original bill of sale, is required to validate the warranty.

Repair or replacement of the "Country Smoker" part does not extend the limited warranty beyond the five (5) years or three (3) year from date of purchase.

The pouring of liquids on your grill flame will void this warranty.

CCI takes every precaution to utilize materials that retard rust by using high-temperature paint or powder coat, where advisable. Even with these safeguards, the protective coatings can be compromised by various substances and conditions beyond CCI's control. High temperatures, excessive humidity, chlorine, industrial fumes, fertilizers, lawn pesticides and salt are some of the substances that can affect paint and metal coatings. For these reasons, the limited warranties DO NOT COVER RUST OR OXIDIZATION, unless there is loss of structural integrity on the grill component. Should any of the above occur, kindly refer to you Instruction Manual's maintenance section for paint finish protection. CCI recommends that you purchase a CCI full length protective cover, and cover your grill when not in use.

The warranties are based on normal domestic use and service of the grill and neither limited warranty coverage's apply for a grill which is used in commercial applications.



Limited Warranty

Exceptions to the Limited Warranty

There is no written or implied performance warranty on "Country Smoker" appliances, as the manufacturer has no control over the installation, operations, cleaning, maintenance or the type of fuel burned.

This limited warranty will not apply nor will CCI assume responsibility if your appliance has not been installed, operated, cleaned and maintained in strict accordance with the manufacturer's instructions. Burning other than quality wood pellets may void the warranty. The warranty does not cover damage or breakage due to misuse, improper handling or modifications.

NEITHER THE MANUFACTURER, NOR THE SUPPLIERS TO THE PURCHASER, ACCEPTS RESPONSIBILITY, LEGAL OR OTHERWISE, FOR THE INCIDENTAL OR CONSEQUENTIAL DAMAGE TO THE PROPERTY OR PERSONS RESULTING FROM THE USE OF THIS PRODUCT. ANY WARRANTY IMPLIED BY LAW, INCLUDING BUT NOT LIMITED TO IMPLIED WARRANTIES OF MERCHANTABILITY OR FITNESS, SHALL BE LIMITED TO ONE (1) YEAR FROM THE DATE OF ORIGINAL PURCHASE. WHETHER A CLAIM IS MADE AGAINST THE MANUFACTURER BASED ON THE BREACH OF THIS WARRANTY OR ANY OTHER TYPE OF WARRANTY EXPRESSED OR IMPLIED BY LAW, MANUFACTURER SHALL IN NO EVENT BE LIABLE FOR ANY SPECIAL, INDIRECT, CONSEQUENTIAL OR OTHER DAMAGES OF ANY NATURE WHATSOEVER IN EXCESS OF THE ORIGINAL PURCHASE PRICE OF THIS PRODUCT. ALL WARRANTIES BY MANUFACTURER ARE SET FORTH HEREIN AND NO CLAIM SHALL BE MADE AGAINST MANUFACTURER ON ANY ORAL WARRANTY OR REPRESENTATION.

Some states do not allow the exclusion or limitation of incidental or consequential damages, or limitations of implied warranties, so the limitations or exclusions set forth in this limited warranty may not apply to you. This limited warranty gives you specific legal rights and you may have other rights, which vary from state to state

The limited warranties for 5 (five) years or 3 (three) years are in lieu of all other warranties expressed or implied, at law or otherwise, and CCI does not authorize any person or representative to assume for CCI any obligation or liability in connection with the sale of the wood pellet grill. This means that no warranties, either expressed or implied, are extended to persons who purchase the product from any one other than CCI or an authorized CCI Dealer.

Procedures for Warranty Service

Call your nearest "Country Smoker" dealer for repair or replacement of your "in-warranty" parts.

Be prepared to furnish the following information:

1. Copy of the bill of sale.
2. Purchaser's name, model and serial number of grill and date of purchase.
3. An accurate description of the problem.

THIS LIMITED WARRANTY GIVES YOU SPECIFIC LEGAL RIGHTS AND YOU MAY HAVE OTHER RIGHTS, WHICH VARY FROM STATE TO STATE

SERIAL NUMBER AND MODEL NUMBER

YOUR SERIAL NUMBER AND THE MODEL NUMBER OF YOUR "COUNTRY SMOKER" CAN BE FOUND ON THE INSIDE OF YOUR HOPPER LID. BE SURE TO RECORD THESE IN THE SPACE PROVIDED BELOW TO AID YOU IF THEY GET DAMAGED OR LOST.

STAPLE YOUR ORIGINAL BILL OF SALE TO THIS PAGE AS WELL TO ENSURE YOU DO NOT LOSE IT!

MODEL

SERIAL NUMBER

DATE OF PURCHASE

AUTHORIZED DEALER





Available in 5 oz and 24 oz containers



NEW 2009

**Hickory Bacon
Sugar & Spice
Steak Rub**

Our Sauces, Spices and Rubs have NO MSG or MSG added!

ACCESORIES

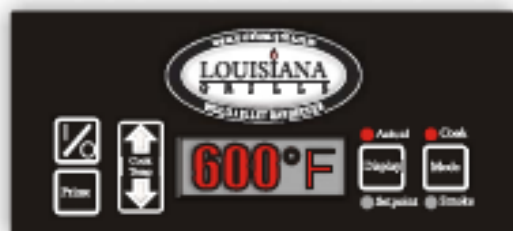

"DIGI - QUE" Digital Oven Control

- Automatically adjusts feed levels to give you virtually consistent temperature output.
- Temperature probe mounts into the cooking area.
- Same unique operations as found on our standard control.
- Can be fitted on any single hopper Country Smoker model

Covers



Enclosure Kits



Hopper Extensions



Shelves

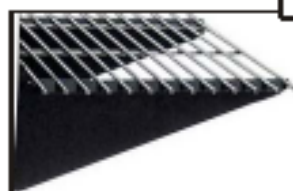

PARTS AND SERVICE

Dansons Group Inc. stands behind our Authorized Dealers. We strongly suggest that if you do need to order any parts or options or require service, that you first deal with your local dealer. Many dealers do stock parts and options.

If for any reason you do not have a local dealer, Dansons Group Inc. is proud to offer the best technical and sales support in the industry. If you require parts, options, rubs and spices, or general accessories you can contact the factory directly :



Louisiana Grills Customer Service

TOLL FREE: 1-877-303-3134

TOLL FREE FAX: 1-877-303-3135

Email: service@dansons.com

Website: www.louisiana-grills.com OR www.countrysmokers.com

CHECK OUR WEBSITE FOR UP TO DATE ACCESSORIES, OPTIONS, AND INFORMATION!!