

This Owner's Manual is provided and hosted by [Appliance Factory Parts](#).

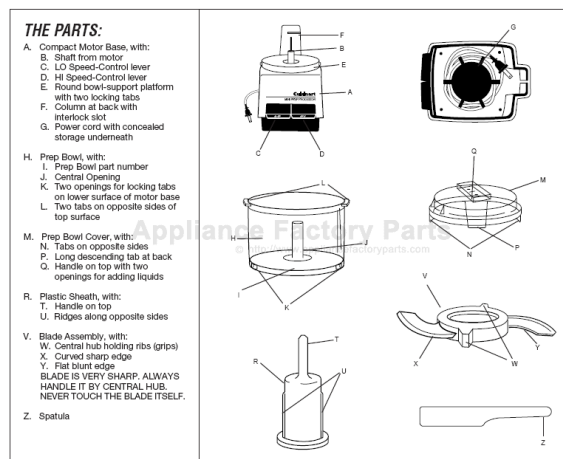

CUISINART DLC-1SS Owner's Manual

[Shop genuine replacement parts for CUISINART
DLC-1SS](#)



[Find Your CUISINART Small Appliance Parts - Select From 213 Models](#)

----- Manual continues below -----

Cuisinart®

INSTRUCTION AND
RECIPE BOOKLET



Mini-Prep® Processor

DLC-1

For your safety and continued enjoyment of this product, always read the instruction book carefully before using.

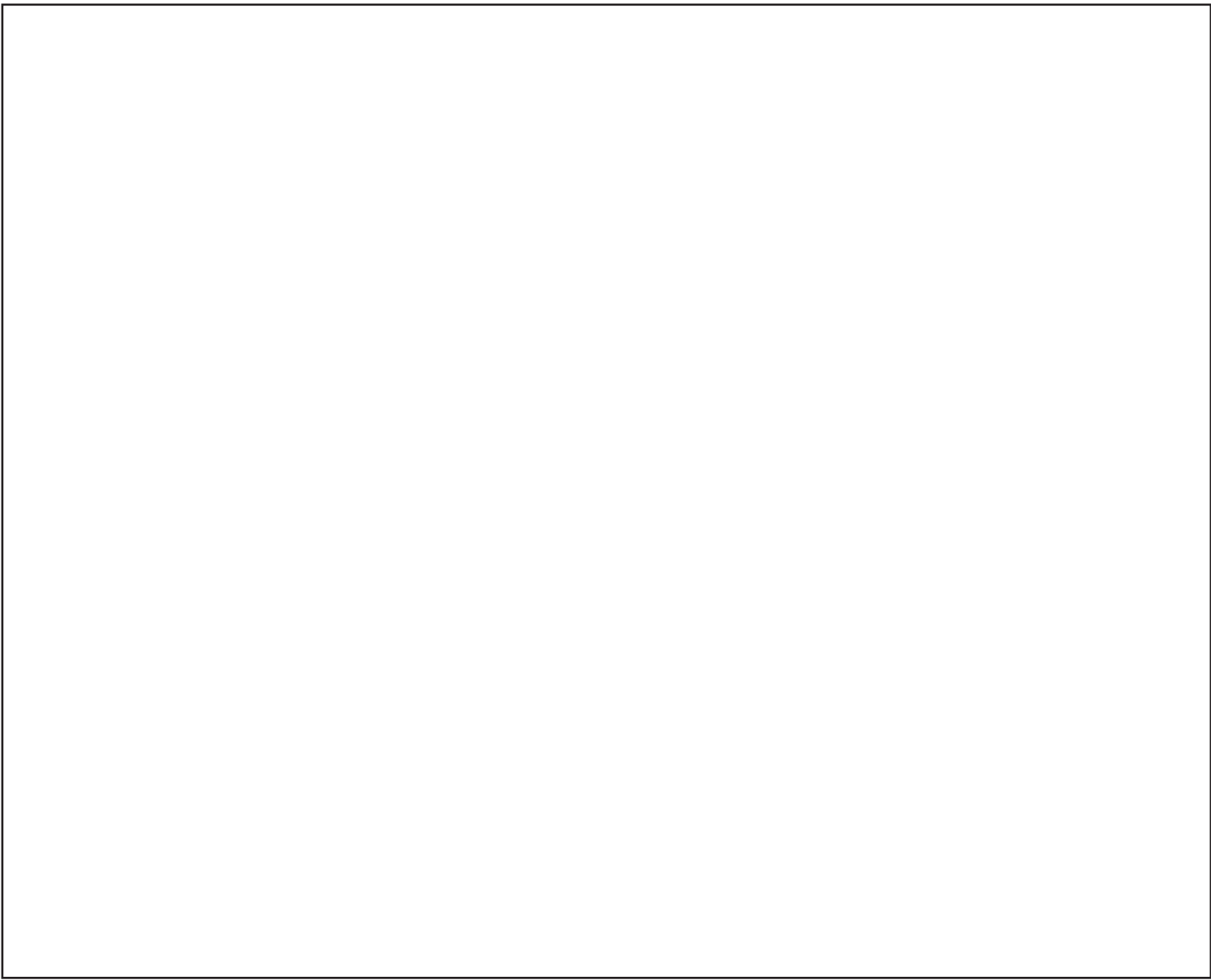

TABLE OF CONTENTS:

IMPORTANT SAFEGUARDS.....	PG 1
INTRODUCTION.....	PG 1
THE PARTS	PG 2
ASSEMBLING THE PARTS.....	PG 3
TIPS FOR PROCESSING.....	PG 4
PROCESSING FOOD.....	PG 5
OPERATING TECHNIQUES.....	PG 6
TROUBLESHOOTING	PG 7
CLEANING AND STORAGE.....	PG 7
RECIPE SUGGESTIONS	PG 7
WARRANTY.....	PG 11

IMPORTANT SAFEGUARDS

When using an electrical appliance, basic safety precautions should always be followed including the following:

1. READ ALL INSTRUCTIONS.
2. To protect against risk of electric shock, do not put motor base in water or other liquid.
3. Close supervision is necessary when any appliance is used by or near children.
4. Unplug from outlet when not in use, before putting on or taking off parts, and before cleaning. To unplug, grasp plug and pull from electrical outlet. Never pull cord.
5. Avoid contacting moving parts.
6. Do not operate any appliance with a damaged cord or plug, or after the

appliance malfunctions, or is dropped or damaged in any manner. Return the appliance to the nearest authorized Cuisinart® Service Facility for examination, repair, electrical or mechanical adjustment.

7. The use of attachments not recommended or sold by Cuisinart may cause fire, electric shock or injury.
8. Do not let cord hang over edge of table or counter, or touch hot surfaces.
9. Do not use outdoors.
10. Keep hands and utensils away from moving blade while processing food to reduce the risk of severe injury to persons, or damage to the food processor. A scraper may be used, but must be used only when the food processor is not running.
11. Blade is sharp. Handle carefully when removing, inserting or cleaning.
12. To reduce the risk of injury, never place cutting blade on base without first putting prep bowl properly in place.
13. Be certain cover is securely locked in place before operating appliance. Do not attempt to remove cover until blade has stopped rotating.
14. Do not attempt to defeat the cover interlock mechanism.
15. Check prep bowl for presence of foreign objects before using.

SAVE THESE INSTRUCTIONS

NOTICE

This appliance has a polarized plug (one blade is wider than the other). As a safety feature, this plug will fit in a polarized outlet only one way. If the plug does not fit fully in the outlet, reverse the plug. If it still does not fit, contact a qualified electrician. Do not attempt to defeat this safety feature.

INTRODUCTION

The Cuisinart® Mini-Prep® Processor handles a variety of food preparation tasks including chopping, grinding, puréeing, emulsifying and blending. The patented two-position blade provides a super-sharp edge for the delicate chopping of herbs, and for blending and puréeing other soft foods, while the blunt edge offers a powerful cutting surface to grind through coffee beans, spices and other hard foods. Two operating speeds with pulse activation give maximum control for precision processing.

A powerful high-speed motor works hard and fast to accomplish any small job with ease. Chop herbs, onions, garlic; grind coffee beans, spices, hard cheese; purée baby foods; blend mayonnaise and flavored butters all with the same compact appliance. The Mini- Prep® takes up a minimum of counter space and stores neatly on the countertop or in a cabinet.

THE PARTS:

- A. Compact Motor Base, with:
 - B. Shaft from motor
 - C. LO Speed-Control lever
 - D. HI Speed-Control lever
 - E. Round bowl-support platform with two locking tabs
 - F. Column at back with interlock slot
 - G. Power cord with concealed storage underneath
- H. Prep Bowl, with:
 - I. Prep Bowl part number
 - J. Central Opening
 - K. Two openings for locking tabs on lower surface of motor base
 - L. Two tabs on opposite sides of top surface
- M. Prep Bowl Cover, with:
 - N. Tabs on opposite sides
 - P. Long descending tab at back
 - Q. Handle on top with two openings for adding liquids
- R. Plastic Sheath, with:
 - T. Handle on top
 - U. Ridges along opposite sides
- V. Blade Assembly, with:
 - W. Central hub holding ribs (grips)
 - X. Curved sharp edge
 - Y. Flat blunt edge

BLADE IS VERY SHARP. ALWAYS HANDLE IT BY CENTRAL HUB. NEVER TOUCH THE BLADE ITSELF.
- Z. Spatula

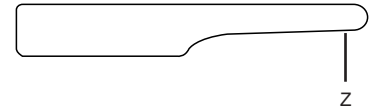
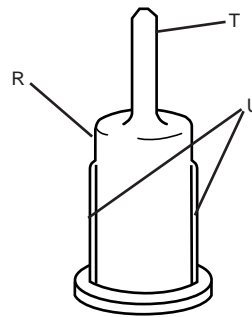
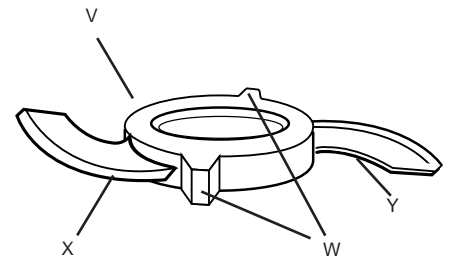
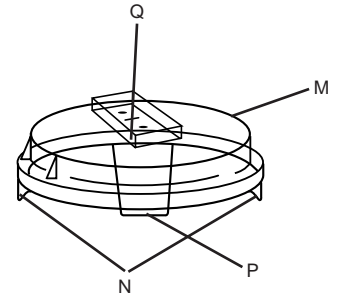
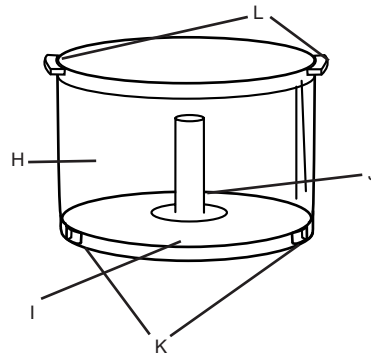
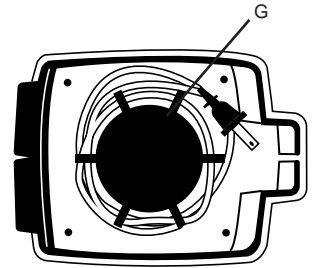
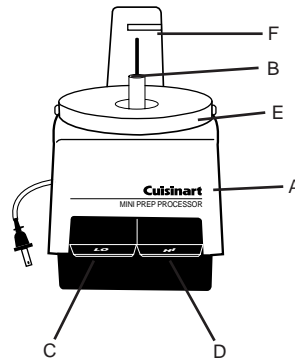

ASSEMBLING THE PARTS

Before you process any food, assemble the parts and try the HI and LO processing speeds to get a feel for how your Mini-Prep® Processor works.

1. Place the **Motor Base** on a flat, dry, stable surface. It should be close to an electrical outlet of the same voltage as that stated on the bottom of the unit.
2. Locate part number on bottom of **Prep Bowl**. Place the **Prep Bowl** on the motor base with the **Prep Bowl** part number slightly to the left of center, then rotate it *counterclockwise* until it locks and clicks into position. Rotate Prep Bowl following direction of **Bowl Lock** arrows printed on motor base.
3. Connect the **Blade Assembly** to the **Blade Sheath**. HOLD THE BLADE ASSEMBLY BY THE CENTRAL HUB

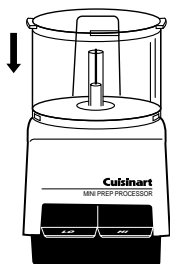

HOLDING RIBS (grips) ONLY. DO NOT TOUCH THE RAZOR-SHARP BLADES.

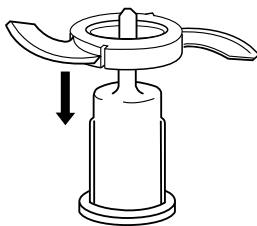

Note these important features of the **Blade Assembly**.

- The **Assembly** can be placed over the **Sheath** in two different ways.

If you hold it this way (A), you will see the word "Sharp" on the blade. Assemble the blade this side up to use the sharp edge. (See the section on processing food for information about when to use the sharp edge.)

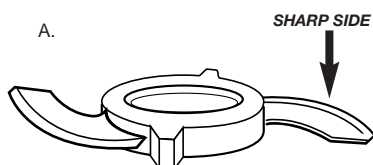

If you hold it this way (B), you will see no writing on the blade. Assemble the blade this side up to use the blunt edge. (See the section on processing food for information about when to use the blunt edge.)

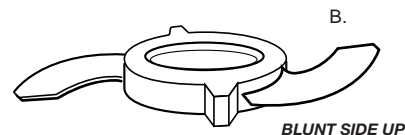

- There are notches (C) on opposite sides of the interior of the hub. These fit over ridges on the sides of the **Sheath**.

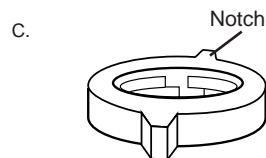

Place the **Sheath**, handle side up, on a flat surface. Pick up the **Blade Assembly** by its hub holding ribs (grips) and line up the notches in the interior of the hub with the ridges on the sides of the **Sheath**. Let the **Blade Assembly** slide down to the bottom of the **Sheath**.

Lift the **Sheath** by its handle. Hold the **Blade Assembly** by its hub holding ribs (grips) and turn it very slightly *clockwise*. This locks it in place on the **Sheath** and prevents it from sliding up during processing.

4. Hold the **Sheath** by its top handle, place it over the central opening of the **Bowl**, and slide the **Sheath** down over the motor shaft. The lower blade on the **Blade Assembly**

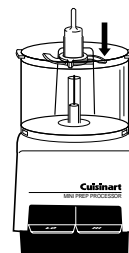

should almost touch the bottom of the **Prep Bowl**.

5. Hold the cover by its handle on the top, with the descending tab in about the 2 o'clock position (D).

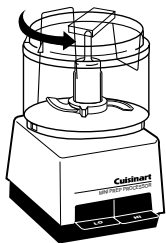

D. While holding the **Motor Base**, press the cover onto the **Prep Bowl**. Use the handle to turn it *counterclockwise* until the descending tab

on the back locks into the slot on the column of the **Motor Base**. IF THE TAB DOES NOT FULLY OR COMPLETELY ENGAGE IN THE SLOT, THE MOTOR WILL NOT START.

6. Plug the cord into an electrical outlet.
7. Place one hand on the cover of the unit, and press the **LO Speed-Control Lever** with the thumb or forefinger of your other hand. Remove your thumb or finger from the control.
8. Now press and release the **HI Speed-Control Lever**.

9. WHEN THE BLADE STOPS MOVING, remove the cover by turning it gently *clockwise* and lifting it straight up.

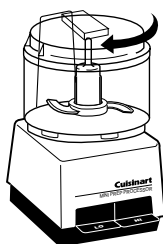

10. Now you are ready to process food.

11. **Disassembling the Blade Assembly**

Lift the **Sheath**. Holding the **Blade Assembly** stationary, carefully turn the **Sheath Cylinder** *clockwise*, then guide the **Blade Assembly** up over the **Sheath**.

TIPS FOR PROCESSING FOOD

Preparing the Food

Size:

Always cut large pieces of food into smaller pieces of even size – about 1/2 inch (12mm) to a side. If you don't start with pieces that are small and uniform, you will not get an even chop.

Quantity:

Do not overload the Prep Bowl. Overloading causes inconsistent results and it strains the motor. Use the quantities given in the recipe section as a guide. As a rule of thumb, remember that after being processed, food should not reach more than 2/3 of the way up the Sheath of the Blade Assembly.

Selecting the Right Blade Edge

Use the **sharp** edge for chopping, puréeing and mixing. It is the right choice, for example, for chopping soft, fragile food such as herbs, celery, onions, garlic and most cheese. It is also the right choice for puréeing cooked vegetables, making mayonnaise and mixing salad dressing.

Use the **blunt** edge for grinding coffee beans and spices, and for chopping hard food such as peppercorns, seeds, chocolate and nuts.

Selecting the Right Operating Speed

Use low speed (**LO Lever**) for chopping, puréeing, and mixing food with the **sharp** edge of the blade.

Use high speed (**HI Lever**) for grinding and for chopping hard food with the **blunt** edge of the blade.

Note: Due to the powerful motor provided with this unit, Cuisinart recommends using one hand to support the Mini-Prep® during operation. This is especially true of the **Hi** speed.

Selecting the Right Lever Action

Pulse action is best when you are using the **sharp** edge of the blade. Two or three pulses are often enough. Be sure to check the food frequently to prevent overprocessing. If you overprocess, you are likely to get a watery paste instead of a fine chop.

Continuous-hold action is best when you are using the **blunt** edge of the blade. You may have to operate the Mini-Prep® Processor for several seconds to achieve the desired results with some food - as long as 20 seconds for some seeds, or 40 seconds for coffee beans.

When you operate the unit for more than 10 seconds, use a pulse action every 10 seconds or so to allow food to drop to the bottom of the Prep Bowl. This provides more consistent results.

Never operate the Mini-Prep® continuously for longer than 1 minute at a time.

Note: The Prep Bowl and Cover may become scratched when you use them for grinding coffee, grain and spices.

This does not affect the performance of the Mini-Prep® Processor. However, you may want to reserve that bowl for grinding, and purchase an additional bowl and cover set for other uses. These are available from the Cuisinart® Customer Service Department, which you can reach by dialing our toll-free number: 800-726-0190. Ask for Model DLC-195A when ordering.

Summary: Selecting Blade, Speed, and Lever Action

Operation	Blade Edge	Speed	Lever Action
Chopping	Sharp	LO	Pulse
Grinding	Blunt	HI	Continuous

Adding Liquid

You can add liquids such as water, oil or flavoring while the machine is running. You might want to add oil when making mayonnaise or salad dressing, for example. Or you could add vanilla or alcohol when making frozen yogurt.

Pour the liquid through one of the two openings in the cover. **IMPORTANT:** Add liquid through only one opening at a time. The other opening must be left free for air to escape. If both openings are blocked, liquid cannot flow smoothly into the bowl.

Removing Food from the Sides of the Bowl

Occasionally food will stick to the sides of the bowl as you process. Stop the machine to clear it away. AFTER THE BLADE HAS STOPPED MOVING, remove the cover, and use the spatula to scrape the food from the sides of the bowl back into the center.

Reversing the Blade in the Middle of a Processing Task

While preparing some recipes, you may want to switch the blade from **sharp** to **blunt** or vice versa.

1. Be sure neither of the Control Levers is pressed down.
2. Unplug the unit.
3. Remove the cover from the Prep Bowl.
4. Lift the Sheath by its top handle and remove the Blade Assembly. NEVER TOUCH THE BLADE ITSELF.
5. Remove the contents of the bowl to another container.
6. Carefully remove the Blade Assembly, holding it by its Hub Holding Ribs. Turn blade upside-down and reinsert it on the Sheath.
7. Insert the Sheath over the central opening of the empty bowl.
8. Insert the food to be processed.
9. Replace the cover, locking it into place.
10. Plug the unit into the electrical outlet and continue processing.

PROCESSING FOOD

1. **Place the Prep Bowl firmly on the motor base and insert the Blade Assembly.** Be sure the blade is assembled to use the blade edge that is appropriate for the food to be processed.
2. **Place food in the Prep Bowl.** Be sure the food is cut in small pieces, and the bowl is not overloaded.
3. **Lock the Cover into position.** **Note:** Due to the powerful motor provided with this unit, Cuisinart recommends using one hand to support the Mini-Prep® during operation.
4. **Press the appropriate Speed-Control Lever – LO or HI,** depending on the food you are processing.
5. When you have finished processing the food, **stop the machine by releasing the Speed-Control Lever.**
6. **WHEN THE BLADE STOPS MOVING, remove the Cover.**
 - 6a. Unplug the unit.
7. **Carefully remove the Blade Assembly,** holding it by the handle on the top of the Sheath. NEVER TOUCH THE BLADE ITSELF.
8. **Remove food with the spatula.** **Note:** Do not operate Mini-Prep® without food contents in Prep Bowl.

OPERATING TECHNIQUES

Chop, grind and purée small amounts of food with the Mini-Prep® Processor. This table lists a number of ingredients in alphabetical order, and shows the recommended method of processing for each.

Ingredient:	Blade Position/Speed		Comments
	Sharp/LO	Blunt/HI	
anchovies	X		must be cooked crisp
bacon	X		
butter	X		
celery	X		
cheese			
hard*		X	chop no more than 2 ounces (56g) at one time
semi-hard	X		
semi-soft	Sharp/HI		must be chilled
soft	X		must be well chilled
chocolate			chop no more than 1 ounce (28g) at a time
bittersweet		X	better results if chilled/refrigerated
milk chocolate		X	
cinnamon sticks		X	
coffee beans		X	grind no more than 1/2 cup (2 oz., 56g) at a time
fruit chips		X	
garlic	X		
ginger root	X		
grain		X	
green onions	X		
herbs, fresh	X		
horseradish	X		
leeks	X		
macarons	X		must be brittle, like Italian amaretti
meats	X		meats should be cold but not frozen or precooked
mushrooms	X		
nutmeg		X	pulse about 5 times to break apart, then let run until finely chopped
nuts		X	must be chilled
olives	X		
onions	X		
peel, citrus	X		
peppercorns		X	
peppers, dried	X		
peppers, fresh	X		
scallions	X		
seeds		X	like coriander, dill, cumin, poppy, etc.
shallots	X		
vegetables, cooked	Sharp/HI		cook until soft, process to a smooth purée

*If cheese is fresh and slightly crumbly, use the SHARP edge. (Use the BLUNT edge for extremely hard, imported or older cheeses only. Many cheeses available are actually only semi-hard.)

TROUBLESHOOTING

Motor doesn't start or blade doesn't rotate.

- Check that plug is securely inserted into outlet.
- Check that Prep Bowl and cover are securely locked into place.
- Be sure to press only one speed-control lever at a time.

Food is unevenly chopped.

- Either you are chopping too much food at one time, or the pieces are not small enough. Try cutting food into smaller pieces of even size and processing a smaller amount per batch.

Food is chopped too fine or is watery.

- The food is overprocessed. Use brief pulses, or process for less time.

Food collects on Prep Bowl cover or sides of Prep Bowl.

- You may be processing too much food. Turn machine off. When blade stops rotating, remove cover, and clean bowl and lid with spatula.

Food hangs up on blade.

- You may be processing too much food. Carefully remove blade. Remove food from blade with spatula, and start over again.

CLEANING AND STORAGE:

To simplify cleaning, rinse the Prep Bowl, cover and blade immediately after use, so that food won't dry onto them. Wash Blade Assembly, Sheath, Prep Bowl, cover and spatula in warm soapy water. Rinse and dry. Wash the blade carefully.

Avoid leaving it in soapy water where it may disappear from sight.

If you have a dishwasher, you can wash the Prep Bowl, cover, Blade Assembly and spatula on the upper shelf. Insert the Prep Bowl upside-down and the cover right-side up. Put the blade and spatula in the cutlery basket. Unload the dishwasher carefully to avoid contact with the sharp blade. Wipe the motor base clean with a damp sponge or cloth. Dry it immediately. Never submerge the motor base or the plug in water or other liquid.

The Mini-Prep® stores neatly on the countertop in a minimum of space. When it is not in use, be sure to leave it unplugged. The hidden cord storage underneath the motor base will help to keep excess cord off the countertop. Store the unit assembled to prevent loss of parts. Store the blades as you would sharp knives—out of the reach of children.

The Mini-Prep® is intended for HOUSE-HOLD USE ONLY. Any service other than cleaning and normal user maintenance, should be performed by an authorized Cuisinart® Service Representative.

RECIPES

BABY FOOD*

*Puréed Vegetables, Fruit, Meat or Poultry may be prepared by using the following model recipe for **Tiny Tender Peas**.*

Foods may be cooked in a microwave oven, saucepan or steamed in a steamer basket. Some additional water is added

for each of the various cooking methods.

Model Recipe:

1/2 cup (5 ounces, 140g) frozen peas
3 tablespoons hot water (to purée)

Microwave Oven

Place frozen peas in microwave-safe container, and cover with plastic wrap. Cook at 100% power for 5 minutes, stirring once. Let stand covered for 60 seconds.

Saucepan

Place peas and 1/4 cup water in saucepan. Bring to full boil over medium heat, separating with fork. Reduce heat; cover and simmer until tender, about 3 minutes. Drain.

Steamer

Fill saucepan with 1 inch of water. Place steamer basket in saucepan and add peas. Bring to full boil. Separate peas with fork. Let steam for 5 minutes.

Insert blade using SHARP edge. Add peas with the 3 tablespoons hot water. Run at HI speed to purée, about 60 seconds. Stop and scrape bowl. Run at HI speed again until peas are completely puréed, about 30 seconds.

Makes about 1/2 cup (5 oz., 140g) puréed peas.

Note: For very stringy vegetables such as asparagus, press cooked puréed vegetables through a sieve before using.

**Always consult with your physician to know which foods are best for your baby.*

TUNA FISH SALAD

Make this popular tasty sandwich filler with a few quick pulses!

- 1/2 ounce (15g) onion, peeled**
- 1 small celery stalk, about 5 inches (13cm), cut into 1-inch (2.5cm) pieces**
- 1 3-ounce (85g) can tuna fish**
- Freshly ground black pepper to taste**
- 2 tablespoons (30ml) mayonnaise, light or homemade**

Insert blade using BLUNT edge. Add onion and celery to Prep Bowl and pulse at HI speed until coarsely chopped, about 5 pulses. Drain tuna fish and add with pepper and mayonnaise. Pulse twice at HI speed. Serve immediately or refrigerate.

Makes about 3/4 cup (6 ounces, 170g).

CHOPPED MEAT/HAMBURGER

- 5 ounces (140g) boneless round or sirloin, cut into 1/2-inch (1cm) cubes**

Insert blade using SHARP edge. Add beef and run at HI speed for 15 seconds. Scrape down bowl. Run for 15 more seconds for finer texture.

Makes 5 ounces (140g) of chopped beef. Shape into hamburger or use in your favorite recipe, as desired.

GRATED PARMESAN CHEESE

- 2 ounces (55g) Parmesan cheese, cut into 1/2-inch (1cm) pieces**
- Insert blade using SHARP edge. Add

cheese. Run at HI speed for 15 seconds. For a finer texture, run machine 5 seconds longer.

Makes 3/4 cup (2 ounces, 55g) grated cheese.

CHOCOLATE FROSTING

- 1-1/2 cups (6 ounces, 170g) confectioner's sugar**
- 1 ounce (28g) unsweetened chocolate, in 1/2" pieces**
- 2 tablespoons margarine**
- 2 tablespoons milk***
- 1/2 teaspoon vanilla extract**
- 1/8 teaspoon salt**

Insert blade using BLUNT edge. Add sugar and chocolate to Prep Bowl. Pulse on HI speed to coarsely chop chocolate, about 8 pulses. Then process at HI speed until chocolate is finely chopped, about 30 seconds.

In a small saucepan over medium heat, bring margarine and milk to a boil. Add to Prep Bowl and process at HI speed until creamy, about 15 seconds. Add vanilla and salt; process at LO speed to incorporate, about 5 seconds.

Makes 3/4 cup (180 ml) frosting, enough to frost one 8-inch (20cm) round layer cake.

**You may use whole, 2%, 1% or skim milk.*

APPLESAUCE

- 2 small apples, 6 ounces (170g) each**
 - 1/4 cup (2 ounces, 60 ml) water**
- Peel and core apples. Cut into eighths. In small saucepan, cook apples in water

over medium-low heat until apples are soft, about 20-25 minutes. Add additional water while cooking, if necessary, to prevent scorching.

Insert blade using BLUNT edge. For a smooth applesauce, process apples at LO speed until smooth, about 25 sec-onds. For a chunkier applesauce, pulse at LO speed until desired consistency is reached.

GRAHAM CRACKER CRUST

- 8 whole graham crackers, quartered (4 ounces, 113g)**
- 2 tablespoons sugar**
- 5 tablespoons (2-1/2 ounces, 70g) unsalted butter or margarine, melted**

Preheat oven to 375°F (190° C).

Insert blade using SHARP edge. Add half the crackers with all the sugar to the Prep Bowl and pulse 3 times at HI speed to break apart. Then let machine run at HI speed until very finely chopped, about 15 seconds. Add remaining crackers and pulse at HI speed 3 times to break apart. Then let machine run at HI speed until crackers are finely chopped, about 30 seconds.

Add melted butter and process at HI speed until combined, about 10 seconds. Use spatula to scrape Prep Bowl.

Press crumb mixture into bottom and sides of 8-inch (20cm) pie pan. Bake until set and edges begin to lightly brown, about 8 to 10 minutes. Cool before filling. Makes one 8-inch (20cm) pie crust.

CLASSIC MAYONNAISE

- 2 large egg yolks**
- 1 tablespoon red-wine vinegar**
- 1 teaspoon mustard, preferably Dijon-style**
- 1/8 teaspoon freshly ground white pepper**
- 1/8 teaspoon salt**
- 2/3 cup (6 ounces, 175 ml) vegetable oil**

Insert blade using BLUNT edge. Add all ingredients except oil to Prep Bowl. Mix at HI speed to blend, about 15 seconds.

With machine running at HI speed, gradually add oil to one of the recessed areas in the cover so that oil flows through the feed hole in a slow, steady stream.* The mayonnaise will thicken as the oil is added. This takes about 2 minutes. Run machine for about 1 minute, check consistency, and then continue.

Makes 1 cup (8 oz., 250 ml).

**Oil should flow through only one feed hole. If both are used, the flow will be blocked.*

NO-CHOLESTEROL MAYONNAISE

- 1/4 cup egg substitute**
- 1 teaspoon mustard, preferably Dijon-style**
- 1/8 teaspoon freshly ground white pepper**
- 2/3 cup (6 ounces, 175 ml) vegetable oil**

Insert blade using BLUNT edge. Add all ingredients except oil to Prep Bowl. Mix

at HI speed to blend, about 15 seconds.

With machine running at HI speed, gradually add oil to one of the recessed areas in the cover so that oil flows through feed hole in a slow, steady stream.* The mayonnaise will thicken as the oil is added. This takes about 2 minutes. Run machine for about 1 minute, check consistency, and then continue.

Makes 1 cup (8 ounces, 250 ml).

**Oil should flow through only one feed hole. If both are used, the flow will be blocked.*

VINAIGRETTE SALAD DRESSING

- 1 small garlic clove (1/4 ounce, 7g)**
- 3/4 cup (6 ounces, 177 ml) vegetable oil**
- 1/4 cup (2 ounces, 55 ml) red-wine vinegar**
- 1 tablespoon mustard (Dijon-style)**
- 1/8 teaspoon freshly ground white pepper**
- 1/8 teaspoon salt**

Insert blade using SHARP edge. Add garlic and process at HI speed to mince, about 10 seconds. Add remaining ingredients and process at HI speed to mix well, about 5-10 seconds.

Makes about 1 cup (8 ounces, 250 ml).

NO-FAT HERB SALAD DRESSING

A delicious, fresh-tasting dressing with a creamy consistency.

- 1 cup (1/2 ounce, 14g) tightly packed parsley leaves**

- 1-1/2 tablespoons fresh dill or 1/2 teaspoon dried dill**
- 1 tablespoon fresh cilantro leaves**
- 1 tablespoon fresh oregano or 1/8 teaspoon dried oregano**
- 1 teaspoon fresh thyme or 1/8 teaspoon dried thyme**
- 1/4 teaspoon salt**
- 1 large shallot (3/4 ounce, 21g)**
- 1/2 cup (4 ounces, 125 ml) non-fat plain yogurt**
- 1/3 cup (2-1/2 ounces, 75 ml) skim milk**
- 2 tablespoons lemon juice**
- 1 tablespoon prepared mustard (Dijon-style)**
- 1 tablespoon balsamic or red-wine vinegar**

Insert blade using SHARP edge. Add parsley, herbs and salt to Prep Bowl. Process at HI speed until finely chop-ped, about 45 seconds. Check consistency and continue processing if necessary.

Peel and quarter shallot. Add to Prep Bowl and process at HI speed until finely chopped, about 15 seconds. Add remaining ingredients and process at HI speed to blend well, about 30 seconds.

Makes 1 cup (8 ounces, 250 ml).

TONNATO SAUCE

This sauce is delicious spread on poached fish, cold poultry or meat.

- 1 can tuna in water (3-1/4 ounces, 92g)**
- 1 2 ounce (56g) can anchovy filets**
- 7 small cornichons (1 ounce, 30g)**
- 2 tablespoons capers**

- 1 **tablespoon prepared mustard (Dijon-style)**
- 1/8 **teaspoon freshly ground white pepper**
- 1/2 **cup (4 ounces, 125 ml) light mayonnaise**

Insert blade using SHARP edge. Add all ingredients except mayonnaise to Prep Bowl and process at HI speed to blend, about 40 seconds. Scrape Prep Bowl, add mayonnaise and blend well at HI speed, about 40 seconds.

Makes 1 cup (8 ounces, 250 ml) or four 2-ounce (60 ml) servings.

WALNUT PESTO SAUCE

- 1 **ounce (28g) Romano cheese**
- 1/4 **cup (1 ounce, 28g) walnuts**
- 1 **large garlic clove (3/4 ounce, 21g)**
- 1/2 **cup (4 ounces, 125 ml) vegetable oil**
- 1 **cup (1/2 ounce, 14g) tightly packed basil leaves**
- 1/8 **teaspoon salt**
- 1/8 **teaspoon freshly ground white pepper**

Insert blade using BLUNT edge.* Cut cheese into 1/2-inch (1cm) pieces. Add to Prep Bowl with walnuts. Chop coarsely at HI speed about 10 seconds. Add garlic, oil and basil leaves. Process at HI speed to purée, about 45 seconds. Scrape Prep Bowl. Add salt and pepper, and process to blend at HI speed, 10 seconds.

Makes about 1 cup (8 ounces, 250 ml).

If cheese is not extremely hard, use the sharp edge to process. Then reverse blade to Blunt edge for remainder of recipe.

LEMON GARLIC BUTTER

- 1/4 **cup (3.5g) tightly packed parsley leaves**
- 1/2 **teaspoon fresh or dried rosemary leaves**
- 1 **large garlic clove (3/4 ounce, 21g)**
- 2 **tablespoons lemon juice**
- 1/2 **teaspoon prepared mustard (Dijon-style)**
- 1/4 **teaspoon salt**
- 1/8 **teaspoon freshly ground white pepper**
- 1/2 **cup (4 ounces, 113g) unsalted butter, cut into 8 pieces, at room temperature.**

Insert blade using SHARP edge. Process parsley and rosemary at HI speed until finely chopped, about 20 seconds. Add remaining ingredients, except butter. Process at HI speed to blend well, about 30 seconds. Scrape Prep Bowl. Remove blade and reinsert using BLUNT edge. Add butter and process at LO speed to cream, about 30 seconds.

Makes about 1/2 cup (5 ounces, 140g).

CAJUN SPICE BLEND

The DLC-1 Mini-Prep® Processor grinds spices to a homogeneous fine blend. Comparable prepared spice mixtures cost more and are not as fresh as those you make yourself.

This blend of spices is an excellent seasoning to rub on fish, poultry or pork. It can also be added to bread crumbs for use as a coating or stuffing. For a milder spice blend, reduce the amount of white

peppercorns, cayenne pepper and chili powder to taste.

- 1 **tablespoon coriander seed**
- 1 **tablespoon dried, minced onion**
- 1 **teaspoon dried, minced garlic**
- 1 **teaspoon mustard seed**
- 1 **teaspoon whole white pepper-corns**
- 2 **tablespoons paprika**
- 1 **tablespoon dried parsley flakes**
- 1/2 **tablespoon dried thyme**
- 1/2 **teaspoon celery salt**
- 1/2 **teaspoon chili powder**
- 1/2 **teaspoon ground sage**
- 1/4 **teaspoon cayenne pepper**

Insert blade using BLUNT edge. Add coriander, onion, garlic, mustard seed and peppercorns. Process at HI speed until seeds are finely ground, about 30 seconds. Add remaining ingredients and process at HI speed to blend well, about 30 seconds.

Makes about 1-1/2 ounces (42g) of Cajun Spice Blend. The Cajun Spice Blend may be stored in a tightly sealed jar in a cool, dark place for several months.

GROUND COFFEE BEANS

- 1/2 **cup (2 ounces, 60g) coffee beans**

Insert blade using BLUNT edge. Add beans. Run at HI speed for 30 seconds. For a finer grind, process 30 seconds more.

Makes 1/2 cup (2 ounces, 60g) ground coffee.

GROUND WHOLE GRAIN BERRIES

Adding whole grain flour to all-purpose flour enhances the flavor and nutrient value of homemade baked goods. Whole grain berries, also called groats, are available in most health food stores in a variety of grains such as wheat, rye, barley, soy and triticale.

1/2 cup (approx. 1-1/2 ounces, 40g) whole grain berries

Insert blade using BLUNT edge. Add whole grain berries. Run at HI speed for no more than 60 seconds. Check consistency and continue processing if necessary.

Makes about 3/4 cup (1-1/2 ounces, 40g) whole grain flour.

FRESHLY GROUND NUTMEG

1 whole nutmeg

Insert blade using BLUNT edge. Add nutmeg. Pulse at HI speed to break apart, about 5 pulses; then let the machine run at HI speed for 30 seconds. Stop to check texture. Continue processing for 5-10 more seconds for a finer texture.

Makes 1-1/2 tablespoons ground nutmeg.

BANANA STRAWBERRY SMOOTHIE

- 1 medium banana (6 ounces, 170g)**
- 2 large strawberries, 1/2 ounce (14g) each**
- 1/2 cup (4 ounces, 120 ml) milk***

Cut banana and strawberries into

1/2-inch (1 cm) pieces. Insert blade using BLUNT edge. Add fruit and milk to Prep Bowl and run at HI speed until smooth, about 30 seconds.

Makes about 1-1/3 cups (10 ounces, 300 ml).

*Whole, low-fat or skim milk.

BANANA FROZEN YOGURT

This recipe produces a rich tasting, soft, frozen yogurt. If you prefer a more scoopable texture, use only 1/4 cup (2 ounces, 57g) yogurt.

- 1 large banana (8 oz., 225g)**
- 1/2 cup (4 oz., 113g) non-fat plain yogurt**
- 2 tablespoons sugar**

Cut banana into 1/2-inch pieces. Arrange in a single layer on a tray, and place in freezer until banana is frozen, at least 2 hours.

Insert blade using BLUNT edge. Add banana to Prep Bowl and pulse at HI speed to chop, about 5 pulses. Add yogurt and sugar, and run at HI speed to blend, about 45 seconds.

Makes about 1 cup (8 oz., 250 ml).

CUISINART® MINI-PREP® PROCESSOR

18-Month Limited Warranty

This warranty is available to consumers only. You are a consumer if you are the owner of a Cuisinart® Mini-Prep® Processor that was purchased at retail for personal, family or household use. Except as otherwise required under applicable state law, this warranty is not available to retailers or other commercial purchasers or owners.

We warrant that your Cuisinart® Mini-Prep® Processor will be free of defects in material and workmanship under normal home use for 18 months from the original date of purchase.

We suggest that you complete and return the enclosed warranty registration card promptly to facilitate verification of the date of original purchase. However, return of the warranty registration card is not a condition of this warranty.

If your Cuisinart® Mini-Prep® Processor should prove to be defective within the warranty period, we will repair it, (or, if we think necessary, replace it) without charge to you. To obtain warranty service, please call our Cuisinart Service Center toll-free at 1-800-726-0190 for information and instructions, or write:

Cuisinart®
150 Milford Road
East Windsor, NJ 08520
Attn: Customer Service Center

To facilitate the speed and accuracy of your return, please enclose \$7.00 for shipping and handling of the product. (California residents need only supply a proof of purchase and should call 1-800-726-0190 for shipping instructions.) Please be sure to include a return address, description of the product's defect, product serial number and any other information pertinent to the product's return. Please pay by check or money order.

Your Cuisinart® Mini-Prep® Processor has been manufactured to the strictest specifications and has been designed for use only with authorized Cuisinart® accessory and replacement parts. This warranty expressly excludes any defects or damages caused by accessories, replacement parts or repair service other than those that have been authorized by Cuisinart.

This warranty does not cover any damage caused by accident, misuse, shipment or other than ordinary household use.

This warranty excludes all incidental or consequential damages. Some states do not allow the exclusion or limitation of these damages, so the foregoing limitations or exclusions may not apply to you.

Index to Recipes

Baby Food

- Vegetables, 7
- Fruits, 7
- Meat, 7
- Poultry, 7

Beverages

- Banana Strawberry Smoothie, 11

Cheese

- Grated Parmesan Cheese, 8

Coffee and Grains

- Ground Coffee Beans, 10
- Ground Whole Grain Berries, 11

Desserts

- Applesauce, 8
- Banana Frozen Yogurt, 11
- Chocolate Frosting, 8
- Graham Cracker Crust, 8

Meat & Fish

- Chopped Meat/Hamburger, 8
- Tuna Fish Salad, 8

Sauces and Spreads

- Classic Mayonnaise, 9
- Lemon Garlic Butter, 10
- No-Cholesterol Mayonnaise, 9
- No-Fat Herb Salad Dressing, 9
- Tonnato Sauce, 9
- Vinaigrette Salad Dressing, 9
- Walnut Pesto Sauce, 10

Spice Blends

- Cajun Spice Blend, 10
- Freshly Ground Nutmeg, 11

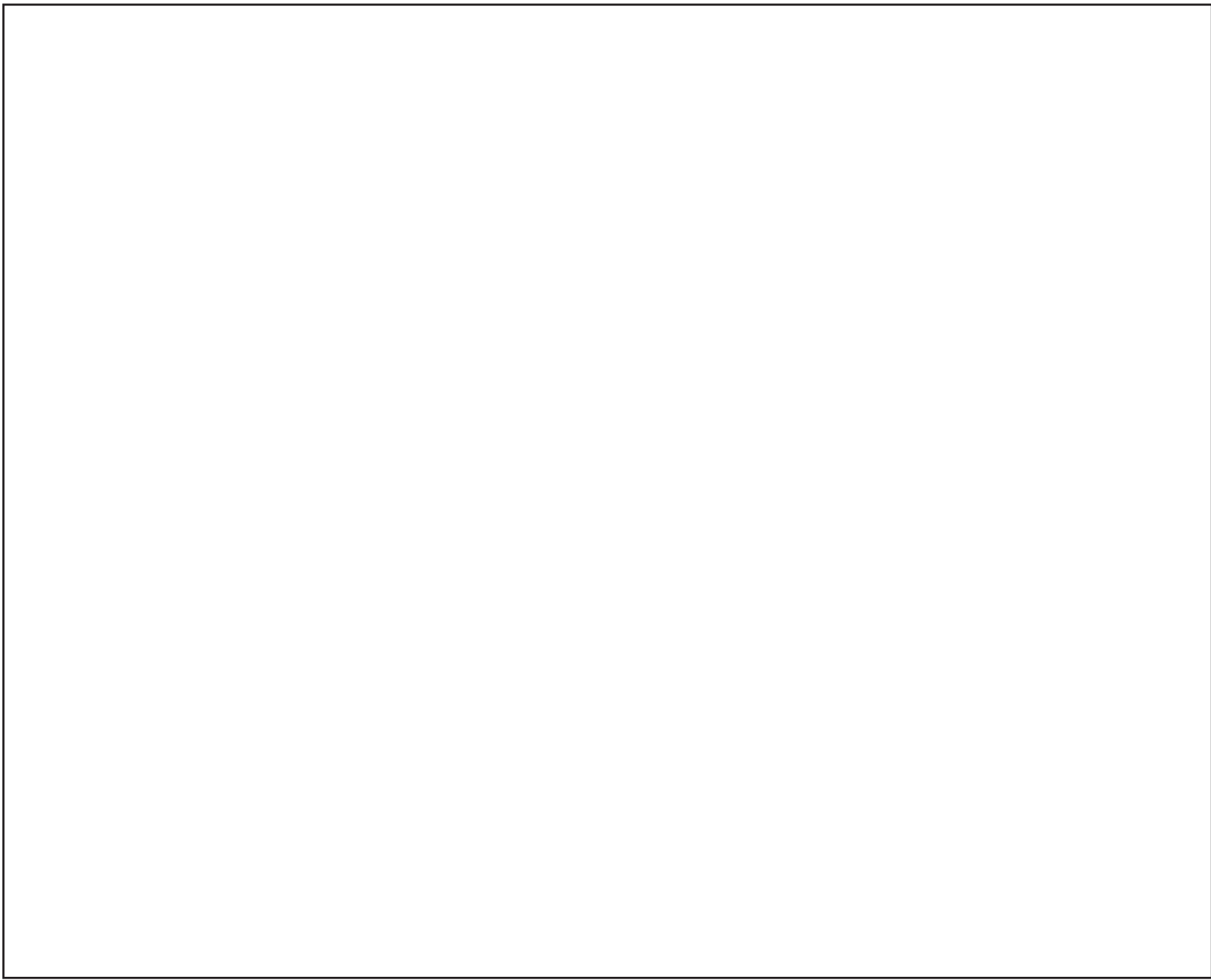

Cuisinart®

SAVOR THE GOOD LIFE®



Food
Processors



Blenders



Toasters



Hand
Blenders



Ice Cream
Makers

Cuisinart offers an extensive assortment of top quality products to make life in the kitchen easier than ever. Try some of our other countertop appliances and cookware, and Savor the Good Life®.

www.cuisinart.com

© 2002 Cuisinart
Cuisinart® is a registered trademark of
Cuisinart
150 Milford Road
East Windsor, NJ 08520
Printed in China
02CU13237
IB-4276