

This Owner's Manual is provided and hosted by [Appliance Factory Parts](http://www.ApplianceFactoryParts.com).

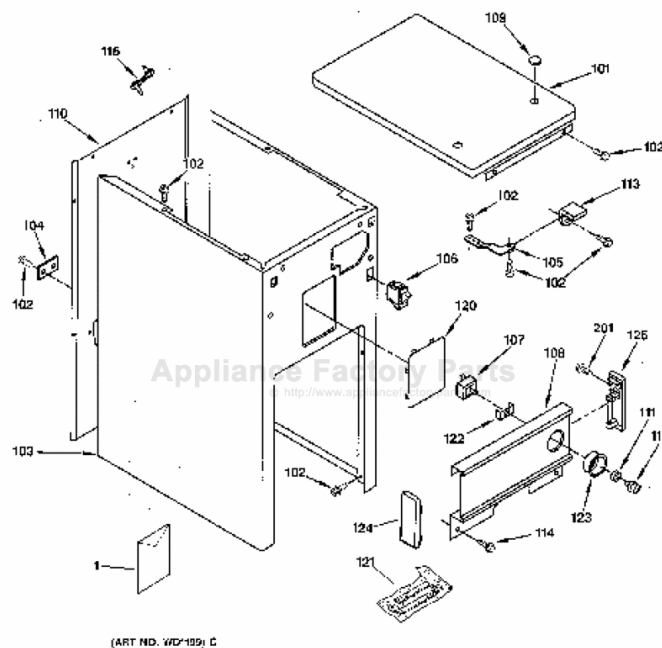

GE GCG1230S6WB Owner's Manual

[Shop genuine replacement parts for GE
GCG1230S6WB](#)









[Find Your GE Trash Compactor Parts - Select From 67 Models](#)

----- Manual continues below -----

Use and Care Guide

Trash Compactor

	Safety instructions3
	Operating Instructions, Tips Appliance Registration.....2 Compacting7 Loading6 Operating Your Compactor4, 5 Removing Full Trash Bag7 Trash Bag Installation6
	Care and Cleaning Cleaning, Inside and Outside8 Changing Color Panel9

	Problem Solver1 More questions ?...call GE Answer Center® 800.626.2000
	Installation Installation 10 Electrical Requirements 10 Grounding 10
	Consumer Services15 Model and Serial Numbers2 Repair Service2 WarrantyBack Cover

Models: GCG1200 GCG1230

GE Quality Product



HELP US HELP YOU...

Before using your compactor, read this book carefully.

It is intended to help you operate and maintain your new compactor properly.

Keep it handy for answers to your questions.

If you don't understand something or need more help, write (include your phone number):

Consumer Affairs
GE Appliances
Appliance Park
Louisville, KY 40225

Write down the model and serial numbers.

You'll find them on a label on the cabinet behind the drawer front.

These numbers are also on the Consumer Product Ownership Registration Card that came with your compactor. Before sending in this card, please write these numbers here:

Model Number

Serial Number

Use these numbers in any correspondence or service calls concerning your compactor.

If you received a damaged compactor...

Immediately contact the dealer (or builder) that sold you the compactor.

Save time and money. Before you call for service . . .

Check the Problem Solver in the back of this book. It lists causes of minor operating problems that you can correct yourself.

IF YOU NEED SERVICE

To obtain service, see the Consumer Services page in the back of this guide.

We're proud of our service and want you to be pleased. If for some reason you are not happy with the service you receive, here are three steps to follow for further help.

FIRST, contact the people who serviced your appliance. Explain why you are not pleased. In most cases, this will solve the problem.

NEXT, if you are still not pleased, write all the details—including your phone number—to:

Manager, Consumer Relations
GE Appliances
Appliance Park
Louisville, KY 40225

FINALLY, if your problem is still not resolved, write:

Major Appliance Consumer Action Panel
20 North Wacker Drive
Chicago, IL 60606

IMPORTANT SAFETY INSTRUCTIONS

Read all instructions before using this appliance.



A WARNING—When using this appliance, always exercise basic safety precautions, including the following:

- This compactor is for household use **only**. Use this appliance only for its intended purpose as described in the Use and Care book.
- To prevent hazard of electrical shock, this compactor must be properly installed and grounded in accordance with the Installation Instructions before it is used. **SAVE YOUR INSTALLATION INSTRUCTIONS FOR FUTURE USE SHOULD YOU MOVE OR RELOCATE YOUR COMPACTOR.** If you did not receive an Installation Instruction sheet with your compactor, you can obtain one by contacting the service location nearest you.
- Close supervision is necessary when any appliance is operated near children. Do not allow the compactor to be used as a toy, or to run unattended at any time.
- **Turn** the key to OFF and remove it when not compacting trash. This will help prevent anyone from tampering with the compactor or children from operating it.
- Do not push trash into the drawer with hands or feet. Trash might contain broken glass, sharp pieces of metal, or other sharp objects that might cause injury.
- When removing or carrying the trash bag, keep the bag away from your body. Sharp objects may have pierced it.
- When cleaning the inside of the cabinet, be careful. Glass fragments may be stuck to the ram or be lying in the bottom of the cabinet.
- When cleaning the trash drawer, be careful. Glass fragments may be imbedded in the surface of the drawer.
- Do not touch moving parts.
-  Do not operate with a damaged cord set, plug, motor, or after damage in any manner. Have the appliance examined, repaired, or adjusted by an authorized serviceman.
- Do not take apart this appliance. Incorrect reassembly can cause electric shock when subsequently used.

- Use only for intended use as described in this manual. Do not use other than manufacturer's recommended accessory.
- Do not compact food waste such as raw meat and **fish**, grapefruit rinds, personal hygiene items and disposable diapers. These items create very strong odors and should not go into the compactor.

Precautions against unreasonable use of your compactor:

- Never compact shotgun shells, cartridges for firearms, fireworks, etc., which are highly explosive.
- Never compact flammable materials such as paint, oil- or gasoline-saturated rags, engine starting fluid cans, paint thinner cans, etc.—spontaneous combustion or explosive vapor concentrations could occur.
- Never compact containers of toxic chemicals such as strong insecticides or other poisonous materials—compaction could release hazardous fumes.
- Never compact aerosol cans containing explosive or highly toxic chemicals. (If you are sure the aerosol cans contain non-hazardous materials such as shaving cream, cheese spread and whipped cream, they may be compacted.)
- Do not compact lighted cigarettes, cigars, or other hot or burning items.
-  Unplug the compactor before making any repairs. Note: We strongly recommend that any servicing be performed by a qualified person.
- **DO NOT USE AN ADAPTER PLUG OR AN EXTENSION CORD WITH THIS APPLIANCE.**
- Do not store or use gasoline or other flammable vapors and liquids in the vicinity of this or any other appliance.

SAVE THESE INSTRUCTIONS



YOUR COMPACTOR

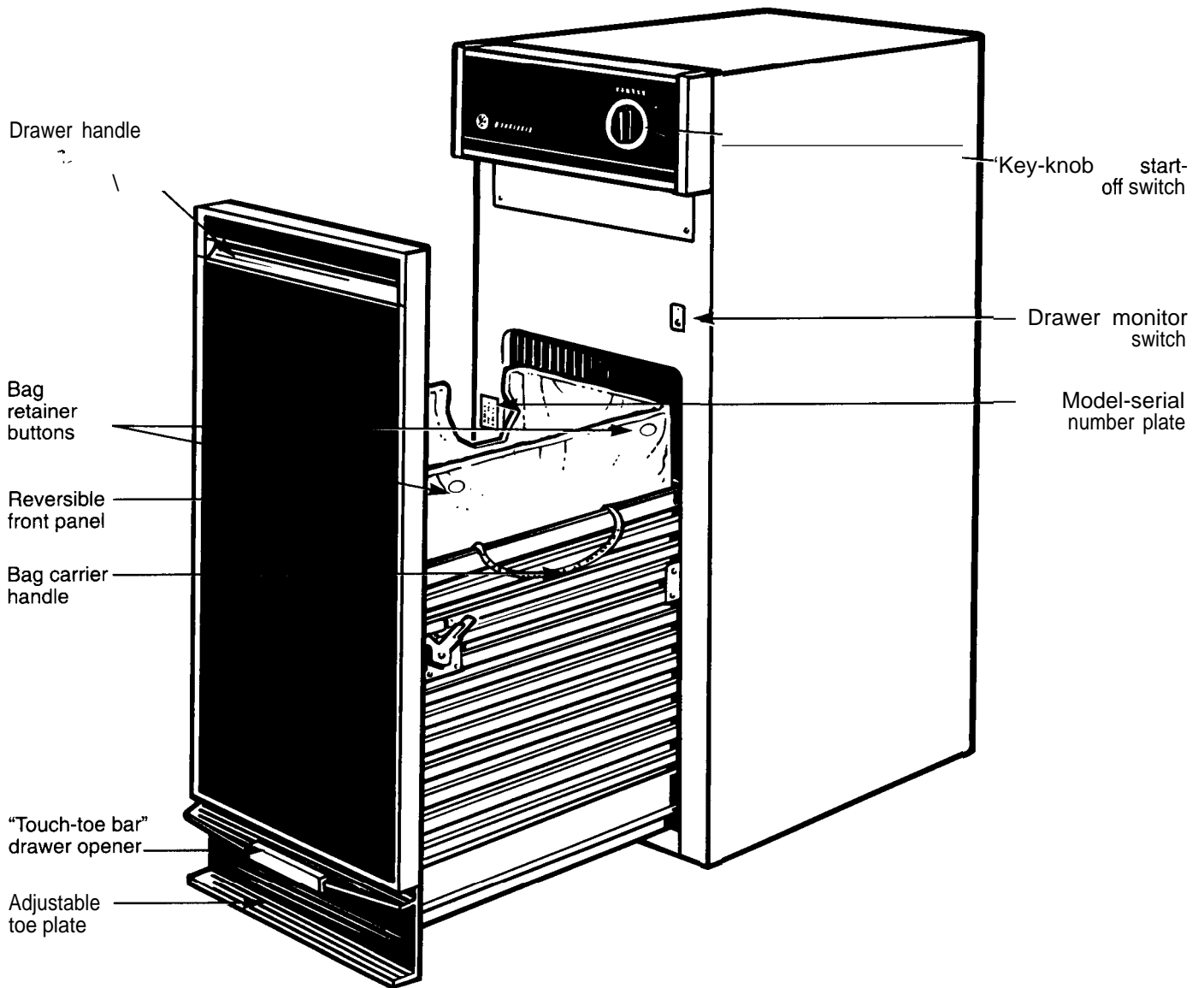



What It Does

Your compactor reduces household trash to as little as 1/4 of its original volume.

It compacts most refuse, including paper, cans, bottles, jars, plastic containers, wrappings, sweepings and some food wastes.

How it Works

Drop trash into a disposable bag that lines the trash drawer and close the drawer. When you start the compactor, an electrically-operated ram moves down into the drawer, compacts trash, moves back up again—and the compactor shuts off automatically.

NOTE: The trash drawer must be 1/3 full before you will notice compaction because the ram does not travel all the way down into the drawer. By adding trash, compaction is transferred to the items below until all trash is compacted.

Key Lock Switch

A key lock switch is provided for your protection as a safety measure. When the key lock switch is in the OFF position, the compactor will not operate. Lock the compactor when it is not in use, and remove the key for safekeeping to keep children from operating the compactor or to prevent anyone from tampering with it.

Drawer monitor switch

The compactor has a position monitor switch to ensure the drawer is in its fully closed position for operation. The compactor will not cycle without the drawer being closed.



USING YOUR COMPACTOR

Trash bag installation

Before installing a new bag, be sure:

1. The drawer side is securely locked.
2. The container is clean and free of sharp debris that may puncture the bag.

Reinforced polyethylene bags came with your compactor and are ready to be installed.

You must use the specially designed heavy-duty trash bags included with your compactor. These bags are available from your dealer or Factory Service Center. Ask for catalog number WC60X5017. If you prefer, you can order by mail. A handy order form is provided with your compactor and is included in every replacement bag package.

1. Fit the bag caddy into the drawer.

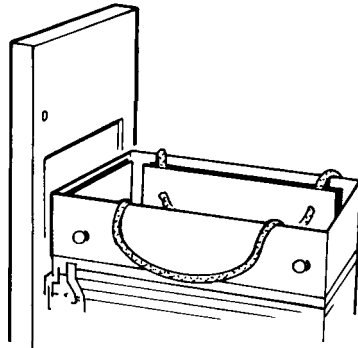

2. Place bag into drawer. Open bag and pull top edges over the drawer top.
3. Lock bag in place by pulling the four prepunched holes over the bag retainer buttons. Holes will expand over the buttons without harming the bag.
4. Press inside of bag against the drawer bottom, sides and corners for a smooth fit.

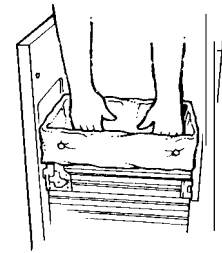
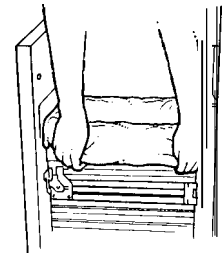

After installing a trash bag, the compactor is ready to use.

Loading

Lift the trash drawer handle or press the touch-toe bar and pull the drawer out.

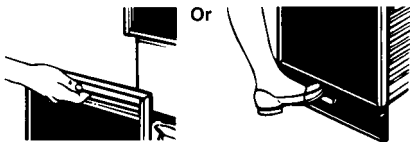

- Bottles and large cans compact best when laid flat near the center of the drawer.

- To help keep the ram clean when compacting messy food waste, place a couple of folded sheets of newspaper or a large grocery bag on top of the load to be compacted.
- Folded newspaper will also help prevent glass fragments from flying out of the drawer when compacting a large glass bottle, or several bottles or jars, or any other items that might shatter.

- Items too bulky to go into the drawer can be folded to fit. If it cannot be folded to fit into the drawer, do not attempt to force it in.
- Although it is not necessary to compact until the drawer is full or nearly full, we suggest that, for maximum compaction, you start the compactor each time a significant amount of trash is added.



Compacting

To start the compactor:

Make sure the drawer is fully closed.

Turn the key-knob to START. Let go of the key-knob. The motor will start and compacting will proceed.

CAUTION: DO NOT FORCE KEY WHEN TURNING. The key should always rotate easily. Forcing may break the key and damage the switch.

The ram travels downward into the drawer, compacting the trash. At the bottom of the stroke, the ram automatically reverses direction, retracts out of the drawer, returns to its starting position, and the compactor shuts off automatically.

The cycle takes about one minute. As the trash drawer fills, cycle time gets progressively shorter.

Glass bottles can make a loud noise when they break during compaction. This is normal. Also, bottles in the trash drawer will not always break during the first cycle. Breaking glass and associated noise may occur several cycles later, depending on the type and volume of the trash.

When bottles and cans are compacted, small tears in the bag may occur. This is normal and in no way affects the performance of the compactor. Always use the bag caddy to carry the compacted trash to storage or pick-up areas, and keep the bag away from your body to prevent injury from sharp objects that may have pierced the bag.

CAUTION: When emptying waste baskets into the trash drawer, some items may spill into the compactor behind the drawer. Items behind the drawer could prevent it from closing completely and prevent the compactor from operating. To remove such items from behind the drawer, open the drawer and, if necessary, remove it to clean them out. See Care and Cleaning instructions.

To Stop Compacting

The compactor may be stopped at any time by turning the key to LOCK/OFF. Turn the key-knob to ON and the compacting ram moves back up to its starting position. You can then open the drawer. To restart the compactor turn the Key-Knob to START.

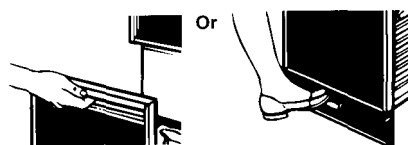

To Remove a Full Trash Bag:

1. Pull the drawer completely open.

2. Remove top of bag from bag retainer buttons. Pull up all four bag cuffs.

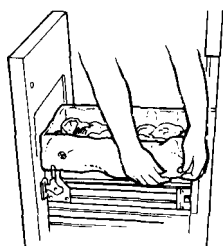

3. Close bag with twist ties provided.

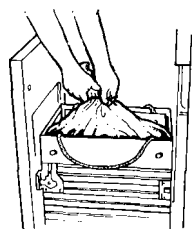

4. Push Side-Lock Latch down and tilt drawer side open.

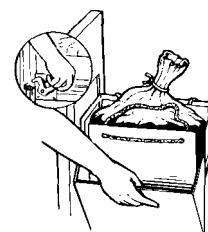

5. Lift bag by bag carrier handles.



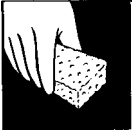

CARE AND CLEANING

As is true of most appliances, proper care is needed to give you continued satisfaction. Before cleaning the compactor, turn the Key-Knob to the OFF position and remove. If you will be away for more than a couple of days, remove the compactor bag. Lock the compactor and remove the Key-Knob. Store the Key-Knob in a safe place. The inside and outside of your compactor are finished with durable baked-on enamel.

Cleaning—Outside

Keep the outside clean. Do not wipe with a soiled dishwashing cloth—it may leave a residue that can damage the paint. Do not use harsh or gritty cleansers or scouring pads that may mar the finish. Apply a coat of kitchen/appliance wax when the compactor is new, and then several times a year. Appliance Polish and Wax Cleaner (Cat. No. WR97X216) is available from GE Parts and Service Centers.

Cleaning—Inside

To clean the drawer interior:

1. Remove the bag. See “Using Your Compactor” section.
2. Wear protective gloves. There may be bits of glass in the drawer.
3. Press Side-Lock Latch down.

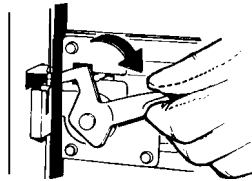

4. Hold Side-Lock Latch and tilt side of drawer until the latch clears the drawer front.

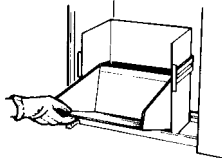

NOTE: Drawer side can be removed by tilting and sliding it out.

5. Wash with damp cloth using warm, sudsy water. Rinse and then dry with a soft cloth.
6. If drawer side was removed, slide it back into the tilted position.
7. Press the Side-Lock Latch down while pressing the side to the upright position.
8. Lock the Side-Lock Latch.

To clean the cabinet interior:

1. Wear protective gloves. There may be bits of glass in the cabinet.
2. Pull the drawer out until it stops.
3. Note the tracks in which the drawer rollers move.

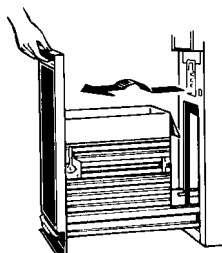

4. Lift the front to clear the drawer stops.
5. Grasp the drawer on the sides.
6. Pull it out the rest of the way.
7. Set it down gently.

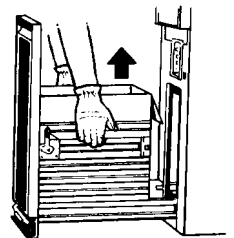

8. Vacuum inside of cabinet. Liquid spills or wet trash should be cleaned up by hand, or use a vacuum designed to pick up liquid.

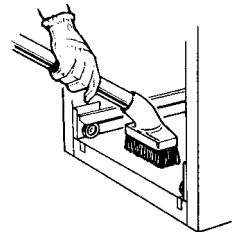

9. Wash, rinse and dry inside.

Wipe off the ram cover:

1. Wear protective gloves. There may be bits of glass on the ram cover.
2. Wipe glass particles off ram cover with a cloth or paper towels.
3. Use warm, sudsy water to remove foods. Rinse and then dry with a soft cloth.
4. Replace drawer.

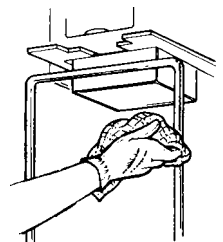

INSTALLATION

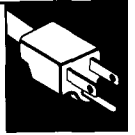

Changing Your Compactor's Color

The color panel on the front of your compactor's drawer reverses to another color.

To change the color of your compactor's front panel, follow the directions below. All you need is a medium-sized screwdriver.

1. Slide drawer out.
2. Remove two screws shown.
3. Remove handle.

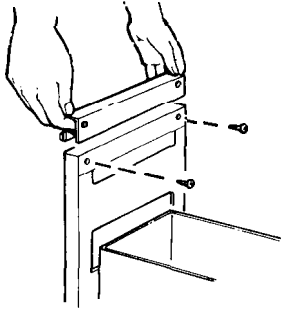

4. Remove the color panel and reverse. Be careful—edges may be sharp.

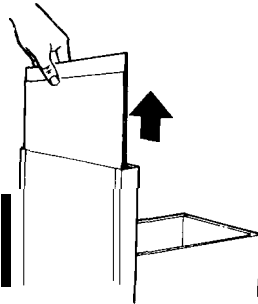

OR

- Place extra panel at front with desired color showing.
5. Make sure panels are all the way down.
6. Be sure to replace cardboard spacer in its former position.

7. Replace handle and screws.
8. Slide drawer back in.

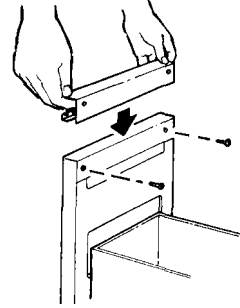

OPTION: Match your kitchen's color scheme by replacing the color panel with your own creation (wallpaper, paneling). See Installation Instructions.

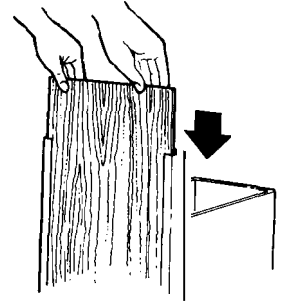

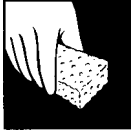

INSTALLATION REQUIREMENTS

IMPORTANT...Please Read Carefully.

How to connect electricity

Caution: Before Plugging In Compactor, Read The Following Electrical Requirements.

Caution: For Personal Safety, Do Not Use An Extension Cord Or Adapter Plug With This Appliance.

Do Not Under Any Circumstances, Cut Or Remove The Third Grounding Prong From The Power Cord.

Follow National Electrical Codes Or Prevailing Local Codes And Ordinances.

This appliance must be supplied with 120V, 60HZ and connected to an individual, properly grounded branch circuit protected by a 15 or 20 amp circuit breaker or time delay fuse.

If the electric supply provided does not meet the above requirements, call a licensed electrician.

It is recommended that a separate circuit serving only this appliance be provided.

Grounding Instructions

This appliance must be grounded. In the event of a malfunction or breakdown, grounding will reduce the risk of electric shock by providing a path of least resistance for electric current.

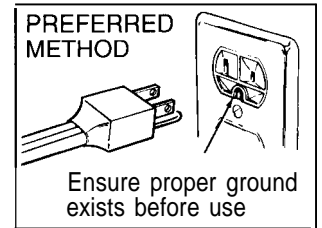

This appliance is equipped with a cord having an equipment grounding conductor and a grounding plug. The plug must be plugged into an appropriate outlet that is properly installed and grounded in accordance with local codes and ordinances.

Danger: Improper connection of the equipment grounding conductor can result in a risk of electric shock. Check with a qualified electrician if you are in doubt as to whether the appliance is properly grounded.

Do not modify the plug with this appliance. If it will not fit the outlet installed, have a proper outlet installed by a qualified electrician.

QUESTIONS? USE THIS PROBLEM SOLVER



PROBLEM	POSSIBLE CAUSE
COMPACTOR DOES NOT OPERATE	<ul style="list-style-type: none"> • May not be plugged into a live electrical outlet. • If plug is secure and compactor still fails to operate, plug a lamp or small appliance into the same outlet to determine if there is a tripped circuit breaker or burned out fuse. • Key lock switch may not be in ON position. • Key lock switch may not have been held at START long enough to start the compaction cycle. • Drawer may not be firmly closed. • Compactor has an automatic thermal cutout. If you have just compacted repeatedly, this protector may have opened the motor circuit. Wait a few minutes and the cutout will reclose automatically.
DRAWER IS HARD TO CLOSE	<ul style="list-style-type: none"> • Trash may have fallen behind the drawer and is preventing the safety switch from being closed.
DRAWER WILL NOT OPEN	<ul style="list-style-type: none"> • Drawer will open only when the ram is all the way up. • To raise the ram, turn the Key-Knob to START and release.
LITTLE OR NO APPARENT COMPACTION	<ul style="list-style-type: none"> • Drawer must be at least 1/3 full of trash before you will see any appreciable amount of compacting because the ram does not travel all the way to the bottom. Trash in bottom of drawer will be crushed during later compaction cycles. • Is the drawer loaded properly? If any thing gets between the ram and the drawer, the ram will return to the "up" position, without compacting. • Compacting works best when only a few items are loaded. Use the compacting cycle frequently for best results.

**If you need more help.. call, toll free:
GE Answer Center™
800.626.2000
consumer information service**

NOTES

NOTES

NOTES

We'll Be There

With the purchase of your new GE appliance, receive the assurance that if you ever need information or assistance from GE, we'll be there. All you have to do is call—toll-free!



GE Answer Center®
800.626.2000

Whatever your question about any GE major appliance, GE Answer Center® information service is available to help. Your call—and your question—will be answered promptly and courteously. And you can call any time. GE Answer Center® service is open 24 hours a day, 7 days a week.

In-Home Repair Service

800-GE-CARES
(800-432-2737)

A GE consumer service professional will provide expert repair service, scheduled at a time that's convenient for you. Many GE Consumer Service company-operated locations offer you service today or tomorrow, or at your convenience (7:00 a.m. to 7:00 p.m. weekdays, 9:00 a.m. to 2:00 p.m. Saturdays). Our factory-trained technicians know your appliance inside and out—so most repairs can be handled in just one visit.



Service Contracts **800-626-2224**

You can have the secure feeling that GE Consumer Service will still be there after your warranty expires. Purchase a GE contract while your warranty is still in effect and you'll receive a substantial discount. With a multiple-year contract, you're assured of future service at today's prices.

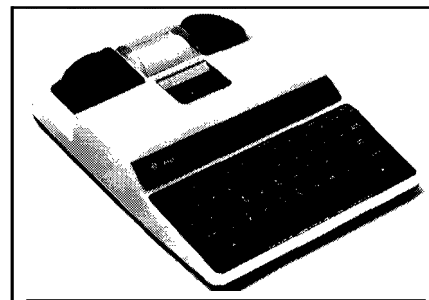

Telecommunication Device for the Deaf

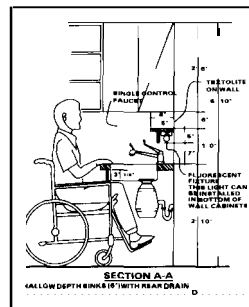

Parts and Accessories **800-626-2002**

Individuals qualified to service their own appliances can have needed parts or accessories sent directly to their home. The GE parts system provides access to over 47,000 parts... and all GE Genuine Renewal Parts are fully warranted. VISA, MasterCard and Discover cards are accepted.

User maintenance **instructions** contained in this **booklet** cover procedures intended to be performed **by my user**. Other servicing **generally** should be referred to **qualified** service personnel. Caution must be **exercised**, since **improper servicing** may cause **unsafe operation**.

For Customers With Special Needs... **800.626.2000**

Upon request, GE will provide Braille controls for a variety of GE appliances, and a brochure to assist in planning a barrier-free kitchen for persons with limited mobility. To obtain these items, free of charge, call 800.626.2000.

Consumers with impaired hearing or speech who have access to a TDD or a conventional teletypewriter may call 800-TDD-GEAC (800-833-4322) to request information or service.

YOUR COMPACTALL® TRASH COMPACTOR WARRANTY

Save proof of original purchase date such as your sales slip or cancelled check to establish warranty period.

WHAT IS COVERED

FULL ONE-YEAR WARRANTY

For one year from date of original purchase, we will provide, free of charge, parts and service labor in your home to repair or replace **any part of the compactor** that fails because of a manufacturing defect.

This warranty is extended to the original purchaser and any succeeding owner for products purchased for ordinary home use in the 48 mainland states, Hawaii and Washington, D.C. In Alaska the warranty is the same except that it is LIMITED because you must pay to ship the product to the service shop or for the service technician's travel costs to your home.

All warranty service will be provided by our Factory Service Centers or by our authorized Customer Care® servicers during normal working hours.

Should your appliance need service during warranty period or beyond, call 800-GE-CARES (800-432-2737)

WHAT IS NOT COVERED

- Service trips to your home to teach you how to use the product.

Read your Use and Care material.

If you then have any questions about operating the product, please contact your dealer or our Consumer Affairs office at the address below, or call, toll free:

GE Answer Center™
800.626.2000
consumer information service

- Improper installation.

If you have an installation problem, contact your dealer or installer. You are responsible for providing adequate electrical, and other connecting facilities.

- Replacement of house fuses or resetting of circuit breakers.
- Failure of the product if it is used for other than its intended purpose or used commercially.
- Damage to product caused by accident, fire, floods or acts of God.

WARRANTOR IS NOT RESPONSIBLE FOR CONSEQUENTIAL DAMAGES.

Some states do not allow the exclusion or limitation of incidental or consequential damages, so the above limitation or exclusion may not apply to you. This warranty gives you specific legal rights, and you may also have other rights which vary from state to state. To know what your legal rights are in your state, consult your local or state consumer affairs office or your state's Attorney General.

Warrantor: General Electric Company

**If further help is needed concerning this warranty, write:
Manager—Consumer Affairs, GE Appliances, Louisville, KY 40225**

Part No. 9870385

Part No. 165 D3080P260
Pub. No. 49-5556

GCG1200
GCG1230