

This Owner's Manual is provided and hosted by [Appliance Factory Parts](http://ApplianceFactoryParts.com).

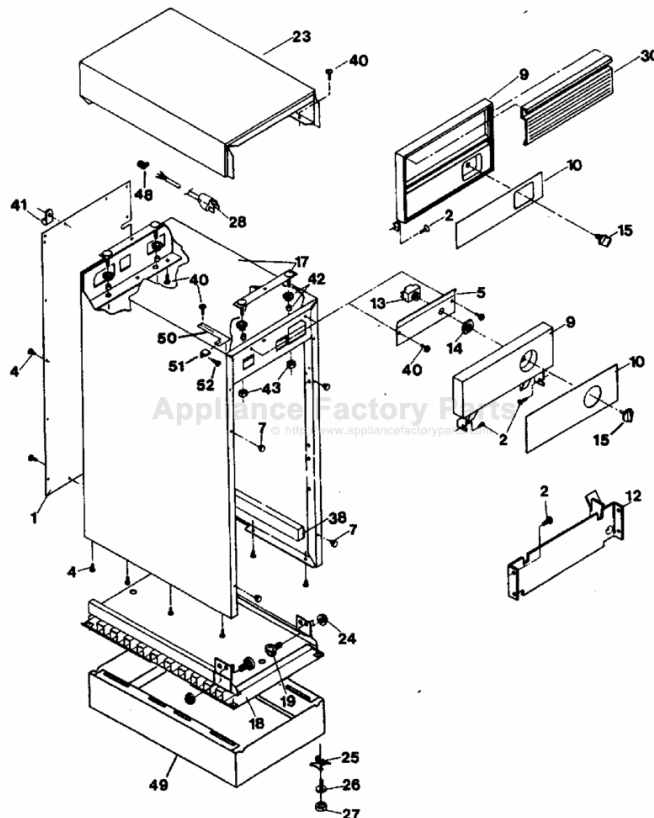

GE ZCG3300VWW-02 Owner's Manual

[Shop genuine replacement parts for GE
ZCG3300VWW-02](#)



[Find Your GE Trash Compactor Parts - Select From 67 Models](#)

----- Manual continues below -----

Owner's Manual

Compactor

ZCG3100

ZCG3300

ZCG3500



Monogram®



Safety Instructions 3



Operating Instructions, Tips

Features of Your Compactor 4, 5
Trash Bag Installation 6
Operating Your Compactor..... 7



Care and Cleaning

Changing Front Panel 9
Cleaning—Inside and Outside... 8
When Going on Vacation..... 8



Problem Solver 10

More questions?...call
GE Answer Center®
800.626.2000



Installation

Electrical Requirements 9
Grounding..... 9



Consumer Services 11

Appliance Registration 2
Model and Serial Numbers..... 2
Warranty Back Cover



HELP US HELP YOU...

Before using your compactor, read this book carefully.

It is intended to help you operate and maintain your new compactor properly.

Keep it handy for answers to your questions.

If you don't understand something or need more help, call:

GE Answer Center®
800.626.2000
24 hours a day,
7 days a week

Write down the model and serial numbers.

You'll find them by pulling the drawer out and locating the rating label on the inside wall.

These numbers are also on the Consumer Product Ownership Registration Card that came with your compactor. Before sending in this card, please write these numbers here:

_____ Model Number

_____ Serial Number

For quick reference, the model number is also located behind the key lock switch knob. Turn the knob to the OFF/LOCK position and remove it to reveal the model number.

Use these numbers in any correspondence or service calls concerning your compactor.

If you received a damaged compactor...

Immediately contact the dealer (or builder) that sold you the compactor.

Save time and money. Before you call for service...

Check the Problem Solver in the back of this book. It lists causes of minor operating problems that you can correct yourself.

IF YOU NEED SERVICE

To obtain service, see the Consumer Services page in the back of this guide.

We're proud of our service and want you to be pleased. If for some reason you are not happy with the service you receive, here are some steps to follow for further help.

FIRST, contact the people who serviced your appliance. Explain why you are not pleased. In most cases, this will solve the problem.

NEXT, if you are still not pleased, write all the details—including your phone number—to:

Manager, Customer Relations
GE Appliances
Appliance Park
Louisville, KY 40225

IMPORTANT SAFETY INSTRUCTIONS

Read all instructions before using this appliance.



WARNING—When using this appliance, always exercise basic safety precautions, including the following:

- **This compactor is for household use only.** Use this appliance only for its intended purpose as described in this manual.
- **To prevent hazard of electrical shock, this compactor must be properly installed and grounded in accordance with the Installation Instructions before it is used. SAVE YOUR INSTALLATION INSTRUCTIONS FOR FUTURE USE SHOULD YOU MOVE OR RELOCATE YOUR COMPACTOR.** If you did not receive an Installation Instruction sheet with your compactor, you can obtain one by contacting the service location nearest you.

- **Close supervision is necessary when any appliance is operated near children.** Do not allow the compactor to be used as a toy, or to run unattended at any time.
- **Turn the key to OFF and remove it when not compacting trash.** This will help prevent anyone from tampering with the compactor or children from operating it.

- **Do not push trash into the drawer with hands or feet.** Trash might contain broken glass, sharp pieces of metal or other sharp objects that might cause injury.
- **When removing or carrying the trash bag,** keep the bag away from your body. Sharp objects may have pierced it.
- **When cleaning the inside of the cabinet,** be careful. Glass fragments may be stuck to the ram or be lying in the bottom of the cabinet.
- **When cleaning the trash drawer,** be careful. Glass fragments may be imbedded in the surface of the drawer.
- **Do not touch moving parts.**

- **Do not operate with a damaged cord set, plug, motor or after damage in any manner.** Have the appliance examined, repaired or adjusted by an authorized serviceman.

- **Do not take apart this appliance.** Incorrect reassembly can cause electric shock when subsequently used.
- **Do not compact food waste such as raw meat and fish, grapefruit rinds, personal hygiene items and disposable diapers.** These items create very strong odors and should not go into the compactor.

Precautions against unreasonable use of your compactor:

- Never compact shotgun shells, cartridges for firearms, fireworks, etc., which are highly explosive.
- Never compact flammable materials such as paint, oil- or gasoline-saturated rags, engine starting fluid cans, paint thinner cans, etc.—spontaneous combustion or explosive vapor concentrations could occur.
- Never compact containers of toxic chemicals such as strong insecticides or other poisonous materials—compaction could release hazardous fumes.
- Never compact aerosol cans containing explosive or highly toxic chemicals. (If you are sure the aerosol cans contain non-hazardous materials such as shaving cream, cheese spread and whipped cream, they may be compacted.)
- Do not compact lighted cigarettes, cigars or other hot or burning items.

-
- **Unplug the compactor before making any repairs. NOTE:** We strongly recommend that any servicing be performed by a qualified person.
 - **DO NOT USE AN ADAPTER PLUG OR AN EXTENSION CORD WITH THIS APPLIANCE.**
 - **Do not store or use gasoline or other flammable vapors and liquids in the vicinity of this or any other appliance.**

SAVE THESE INSTRUCTIONS



FEATURES OF YOUR COMPACTOR

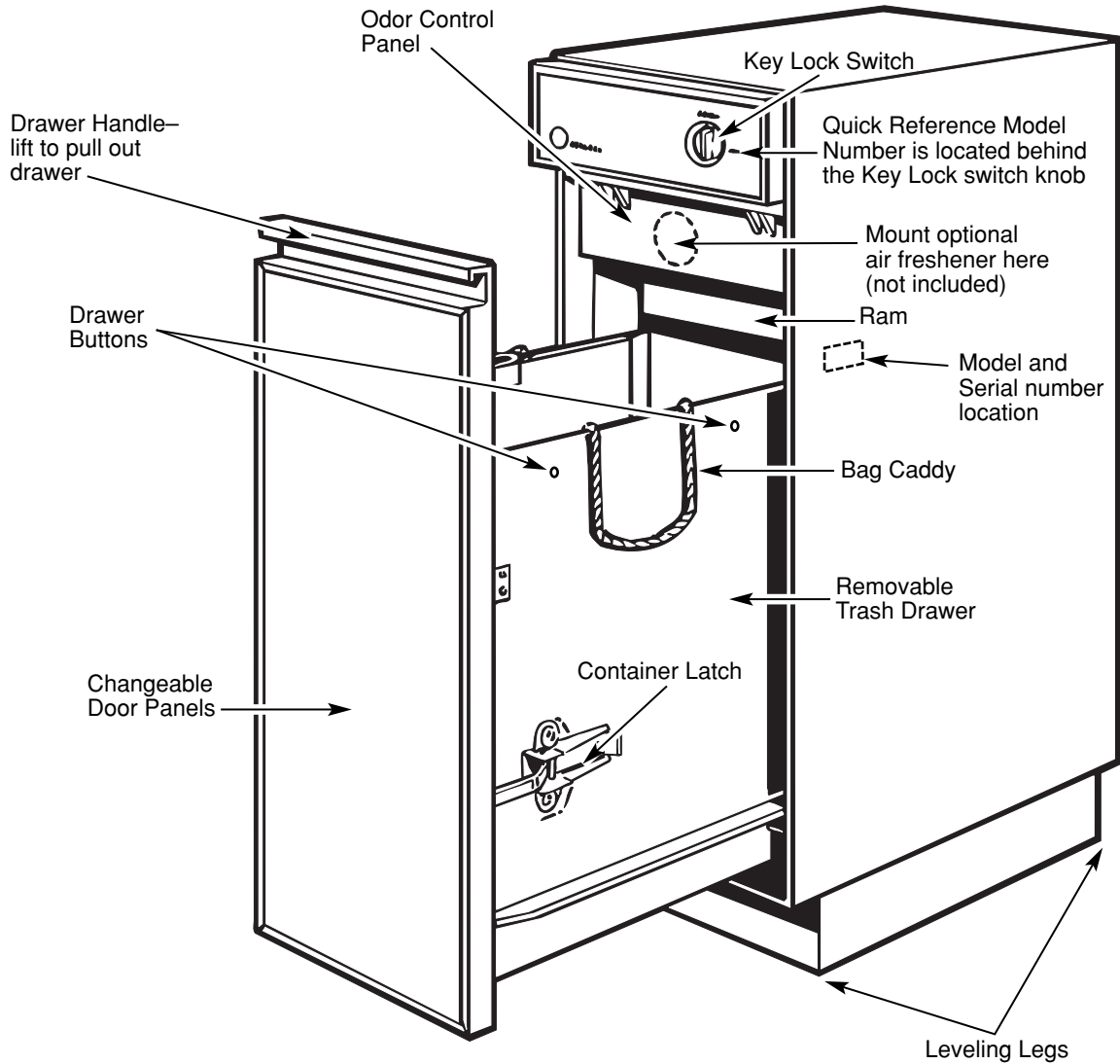

Models ZCG3100 and ZCG3300 come with reversible black and white panels. These units will also accept 1/4" and 3/4" custom panels.

Models ZCG3500 has a stainless steel wrapped drawer panel.



What It Does

Your compactor reduces household trash to as little as 25% of its original volume.

It compacts most refuse, including paper, cans, bottles, jars, plastic containers, wrappings, sweepings and some food wastes.

How it Works

Drop trash into a disposable bag that lines the trash drawer and close the drawer. When you start the compactor, an electrically-operated ram moves down into the drawer, compacts trash, moves back up again—and the compactor shuts off automatically.

NOTE: The trash drawer must be 1/2 full before you will notice compaction because the ram travels only about 2/3 of the way down into the drawer.

Key Lock Switch

A key lock switch is provided for your protection as a safety measure. When the key lock switch is in the OFF position, the compactor will not operate. Lock the compactor when it is not in use, and remove the key for safekeeping to keep children from operating the compactor or to prevent anyone from tampering with it.

Odor Control Panel

A panel behind the drawer front is designed to hold an adhesive backed freshener, such as a Stick-Up brand Air Freshener package. Simply open the drawer and fasten the opened air freshener package on the panel. Replace the air freshener as needed.

Adjustable Base

The base of this compactor can be adjusted forward or backward to achieve a toekick to match the cabinet (see Installation Instructions).



TRASH BAG INSTALLATION

Reinforced polyethylene bags come with your compactor. These bags are ready to be installed.

You must use the specially designed heavy-duty trash bags included with your compactor. Replacement bags can be obtained by calling 800.626.2002. The part number for replacement bags for your model is WC60X5015.

- With trash drawer pulled out to first stop, move the drawer to the second stop by lifting the front of the drawer slightly and pulling forward. Now lower the front edge of the drawer to the floor allowing the rear wheels to remain on the track. This will clear the back of the container from the cabinet for easy installation of the bag.

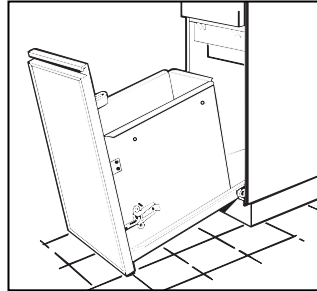

- Set bag caddy into drawer.
- Set trash bag into bag caddy and fold over rear of drawer only.
- Lift drawer in front and reengage wheels on track so that the drawer is self-supporting at its outermost position.

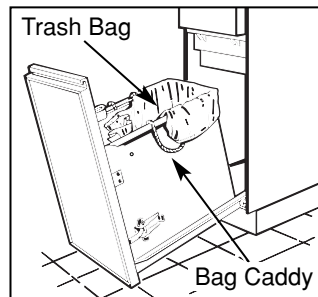

- Open container latch on right side of drawer and swing door open.
- Pull bag over front of drawer and smooth and shape the bag to conform to the drawer. Hook the prepunched holes in the bag over the drawer buttons.
- Gently swing door shut, assuring that the door guide “V” is aligned properly with the “V” groove in the drawer and that the bag is captured just above the “V” groove.

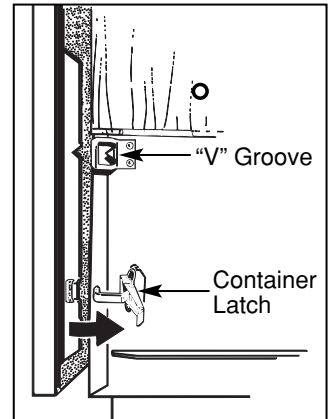
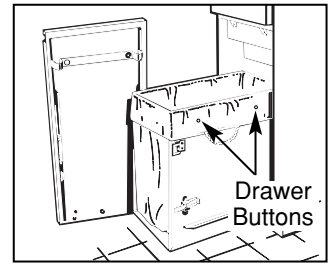

- Finally, use the container latch to completely close the door. This will pull the door guide “V” snug in the “V” groove in the drawer flange and tightly grasp the bag.

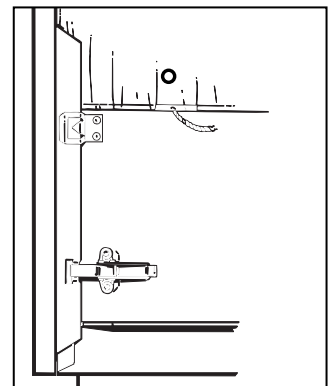

Failure to align the “V”s properly or to latch the drawer to the door may cause the compactor to not function properly.

To remove a full trash bag:

- Pull the drawer out to the first stop.
- Unhook the container latch from the door catch and swing the door open.
- Unbutton the bag and close it by twisting the bag top, much as you would close a garbage bag. Fasten with a twist tie.

- Slip your hand through both handles in the bag caddy and pull upward and forward, tipping the bag toward you. A full bag of compacted trash is easy to carry in this manner.

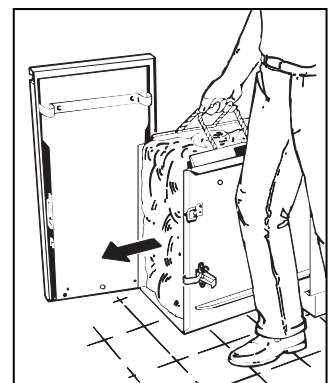

OPERATING YOUR COMPACTOR



After installing a trash bag, the compactor is ready to use.

Loading

Pull the trash drawer out as far as necessary to load the items.

- Bottles and large cans compact best when laid flat near the center of the drawer.
- To help keep the ram clean when compacting messy food waste, place a couple of folded sheets of newspaper or a large grocery bag on top of the load to be compacted.

- Folded newspaper will also help prevent glass fragments from flying out of the drawer into the mechanism when compacting a large glass bottle, or several bottles or jars, or any other items that might shatter.
- Refuse too bulky to go into the drawer can be folded to fit. If it cannot be folded to fit into the drawer, do not attempt to force it in.
- Although it is not necessary to compact until the drawer is full or nearly full, we suggest that, for maximum compaction, you start the compactor each time a significant amount of trash is added.

Compacting

To start the compactor:

1. Close the drawer.
2. Rotate the key past ON to the START position, hold it momentarily at START, and then release it back to ON. The motor will start and compacting will proceed.

CAUTION: DO NOT FORCE KEY WHEN TURNING. The key should always rotate easily. Forcing may break the key and damage the switch.

The ram travels downward into the drawer, compacting the trash. At the bottom of the stroke, the ram automatically reverses direction, retracts out of the drawer, returns to its starting position and the compactor shuts off automatically.

The cycle takes about one minute. As the trash drawer fills, cycle time gets progressively shorter.

Glass bottles can make a loud noise when they break during compaction. This is normal. Also, bottles in the trash drawer will not always break during the first cycle. Breaking glass and associated noise may occur several cycles later, depending on the type and volume of the trash.

When bottles and cans are compacted, small tears in the bag may occur. This is normal and in no way affects the performance of the compactor. Always use the bag caddy to carry the compacted trash to storage or pick-up areas, and keep the bag away from your body to prevent injury from sharp objects that may have pierced the bag.

CAUTION: When emptying waste baskets into the trash drawer, some items may spill into the compactor behind the drawer. Items behind the drawer could prevent it from closing completely and prevent the compactor from operating. To remove such items from behind the drawer, open the drawer and, if necessary, remove it to clean them out. See Care and Cleaning instructions.

To Stop Compacting

The compactor may be stopped at any time by turning the key to OFF. Restarting the compactor will allow the ram to move upward into its starting position.

Anti-Jamming Feature

Should unusual loads cause misalignment, compactor will automatically stop to prevent damage to the unit. To reset the unit and return the ram to the UP position, **turn the** key switch to START and hold momentarily at START, then release it back to ON. The motor will start and the ram will return to the UP position and stop. Redistribute the load evenly in the drawer, placing bottles and large cans flat and centered in the drawer, before recycling the compactor.



CARE AND CLEANING

The inside and outside of your compactor are finished with durable baked-on enamel.

Cleaning—Outside

Keep the outside clean. Do not wipe with a soiled dishwashing cloth—it may leave a residue that can damage the paint. Do not use harsh or gritty cleansers or scouring pads that may mar the finish. Apply a coat of kitchen/appliance wax when the compactor is new, and then several times a year. Appliance Polish and Wax Cleaner (Cat. No. WR97X216) is available from GE Appliance Parts Marts.

Stainless Steel Panels. The stainless steel panels can be cleaned with Stainless Steel Magic or a similar product using a clean, soft cloth. You can order Stainless Steel Magic (Cat. No. WX10X15) through GE Parts by calling 800.626.2002.

When going on vacation

For vacations or other extended absences, remove the trash bag to prevent a build-up of undesirable odor.

Cleaning—Inside

To clean the cabinet interior:

1. Pull out trash drawer until it stops.
2. Lift up on drawer slightly, then pull out drawer to second stop.
3. Lift drawer up and out of compactor.
4. Vacuum clean cabinet base, track channels and drawer, particularly in corners.
5. Wash the cabinet interior and trash drawer with normal mild household cleaners, rinse and dry with a clean cloth. Be sure trash drawer is thoroughly dry before inserting a new bag.

⚠ WARNING: Glass fragments may be lying in bottom of cabinet. To avoid injury, use care in cleaning.

To clean the ram:

With trash drawer out of cabinet, remove the ram as follows:

1. Remove bolt in center of ram with a 1/2" wrench.

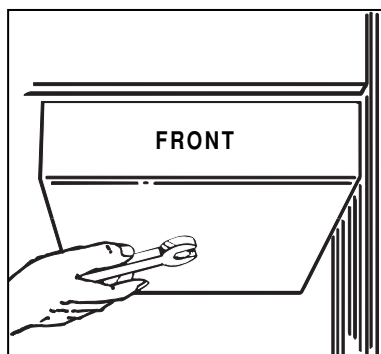

2. Place hand on ram face, being careful to support its entire length.

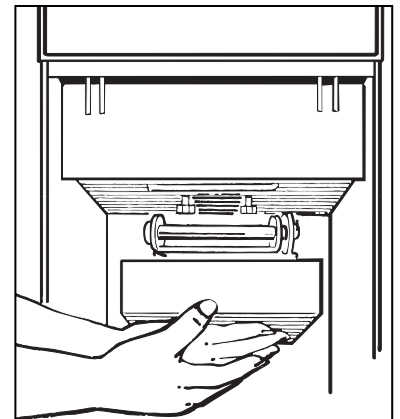

3. With other hand, press back on front of ram, sliding it until it releases.

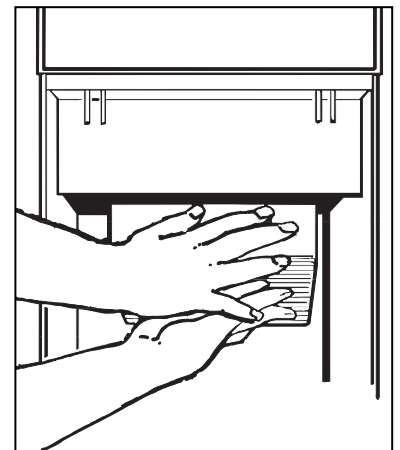

4. Clean ram with normal mild household cleaners, rinse and dry.
5. Fit ram into grooves on the compacting mechanism and slide it forward until it snaps into position.
6. Replace center bolt removed in Step 1.

⚠ CAUTION: WATCH FOR GLASS FRAGMENTS.



Changing Front Panel (Models ZCG3100 and ZCG3300 only)

Remove drawer by pulling to first stop and lifting front to clear second stop. Place drawer on its back. Remove two screws in bottom edge of trim. Slide panel out and reverse. Reinstall trim and place drawer back in compactor.

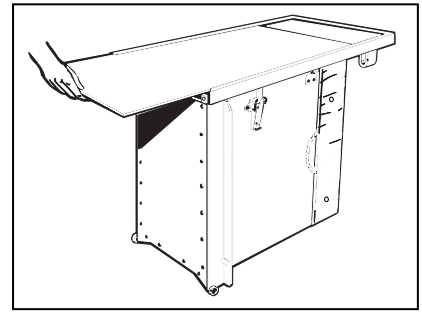
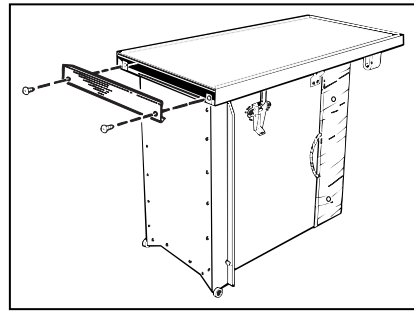

INSTALLATION

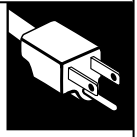

Electrical Requirements

⚠ CAUTION: Before Plugging In Compactor, Read The Following Electrical Requirements.

⚠ CAUTION: For Personal Safety, Do Not Use An Extension Cord Or Adapter Plug With This Appliance.

Do Not Under Any Circumstances, Cut Or Remove The Third Grounding Prong From The Power Cord.

Follow National Electrical Codes Or Prevailing Local Codes And Ordinances.

This appliance must be supplied with 120V, 60HZ and connected to an individual, properly grounded branch circuit protected by a 15 or 20 amp circuit breaker or time delay fuse.

If the electric supply provided does not meet the above requirements, call a licensed electrician.

Grounding Instructions

This appliance must be grounded. In the event of a malfunction or breakdown, grounding will reduce the risk of electric shock by providing a path of least resistance for electric current.

⚠ DANGER: Improper connection of the equipment grounding conductor can result in a risk of electric shock. Check with a qualified electrician if you are in doubt as to whether the appliance is properly grounded.

Do not modify the plug with this appliance. If it will not fit the outlet installed, have a proper outlet installed by a qualified electrician.

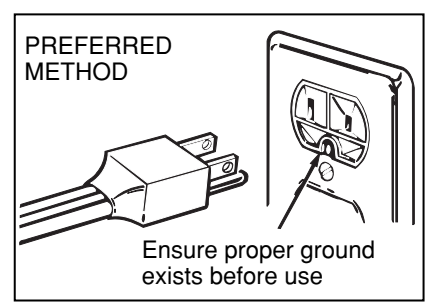

This appliance is equipped with a cord having an equipment grounding conductor and a grounding plug. The plug must be plugged into an appropriate outlet that is properly installed and grounded in accordance with local codes and ordinances.



QUESTIONS? USE THIS PROBLEM SOLVER

PROBLEM	POSSIBLE CAUSE
COMPACTOR DOES NOT OPERATE	<ul style="list-style-type: none">• May not be plugged into a live electrical outlet.• If plug is secure and compactor still fails to operate, plug a lamp or small appliance into the same outlet to determine if there is a tripped circuit breaker or burned-out fuse.• Key lock switch may not be in ON position.• Key lock switch may not have been held at START long enough to start the compaction cycle.• Drawer may not be firmly closed.• Compactor has an automatic thermal cutout. If you have just compacted repeatedly, this protector may have opened the motor circuit. Wait a few minutes and the cutout will reclose automatically.• In the unlikely event that the actuator (on the inside of the door) breaks off, the compactor will not operate. DO NOT ATTEMPT TO OPERATE COMPACTOR IN ANY OTHER MANNER. A replacement actuator can be ordered from Monogram Preferred Service, 800.444.1845.
DRAWER IS HARD TO CLOSE	<ul style="list-style-type: none">• Trash may have fallen behind the drawer and is preventing the safety switch from being closed.
DRAWER WILL NOT OPEN	<ul style="list-style-type: none">• On rare occasions, a large can placed near the side of the drawer may become wrapped around the edge of the ram, interfering with the opening of the drawer. Grasp the drawer handle and move the drawer back and forth until the stuck can becomes dislodged.• The Key/Lock switch may have been turned to OFF/LOCK before the ram returned to the full UP position. Close the drawer and turn the Key/Lock switch to ON. The ram will return to the UP position automatically.• Unusual or unbalanced loads may result in compactor stopping before ram has fully returned to UP position. Turn key switch to START and hold momentarily at START, then release it back to ON. The motor will start and the ram will return to the UP position and stop. To avoid an unbalanced load, distribute the trash evenly in the drawer, keeping bottles and large cans flat and in the center of the drawer.
LITTLE OR NO APPARENT COMPACTION	<ul style="list-style-type: none">• Drawer must be at least 1/2 full of trash before you will see any appreciable amount of compacting because the ram does not travel all the way to the bottom. Trash in bottom of drawer will be crushed during subsequent compaction cycles.
GREASE LEAKING FROM MECHANISM	<ul style="list-style-type: none">• Early in the life of your compactor, grease from the mechanism may drop into the drawer or be found on the front of the bag. This is normal, and will soon stop.

If you need more help...call, toll free:

GE Answer Center®

800.626.2000

consumer information service

With the purchase of your new Monogram appliance, receive the assurance that if you ever need information or assistance from GE, we'll be there. All you have to do is call—toll-free!

Monogram Preferred Service **800.444.1845**

A GE consumer service professional will provide expert repair service, scheduled at a time that's convenient for you. Many GE Consumer Service company-operated locations offer you service today or tomorrow, or at your convenience (7:00 a.m. to 7:00 p.m. weekdays, 9:00 a.m. to 2:00 p.m. Saturdays). Our factory-trained technicians know your appliance inside and out—so most repairs can be handled in just one visit.

GE Answer Center® **800.626.2000**

Whatever your question about any Monogram major appliance, GE Answer Center® information service is available to help. Your call—and your question—will be answered promptly and courteously. And you can call any time. GE Answer Center® service is open 24 hours a day, 7 days a week, or visit our website at: ge.com.

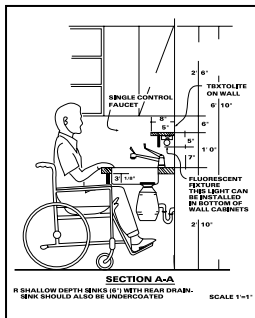

For Customers With Special Needs... **800.626.2000**

Upon request, GE will provide Braille controls for a variety of Monogram appliances, and a brochure to assist in planning a barrier-free kitchen for persons with limited mobility. To obtain these items, free of charge, call 800.626.2000.

Consumers with impaired hearing or speech who have access to a TDD or a conventional teletypewriter may call 800.TDD.GEAC (800.833.4322) to request information or service.

Service Contracts **800.626.2224**

You can have the secure feeling that GE Consumer Service will still be there after your warranty expires. Purchase a GE contract while your warranty is still in effect and you'll receive a substantial discount. With a multiple-year contract, you're assured of future service at today's prices.

Parts and Accessories **800.626.2002**

Individuals qualified to service their own appliances can have needed parts or accessories sent directly to their home. The GE parts system provides access to over 47,000 parts...and all GE Genuine Renewal Parts are fully warranted. VISA, MasterCard and Discover cards are accepted.

User maintenance instructions contained in this booklet cover procedures intended to be performed by any user. Other servicing generally should be referred to qualified service personnel. Caution must be exercised, since improper servicing may cause unsafe operation.

YOUR MONOGRAM COMPACTOR WARRANTY

Staple sales slip or cancelled check here. Proof of original purchase date is needed to obtain service under warranty.

WHAT IS COVERED

From the Date of the Original Purchase

ONE-YEAR

Any part of the compactor which fails due to a defect in materials or workmanship. During this limited one-year warranty, GE will also provide, free of charge, all labor and in-home service to replace the defective part.

.....
This warranty is extended to the original purchaser and any succeeding owner for the products purchased for ordinary home use in the 48 mainland states, Hawaii, Washington, D.C. or Canada. If the product is located in an area where service by a GE Authorized Servicer is not available, you may be responsible for a trip charge or you may be required to bring the product to an Authorized GE Service location for service. In Alaska the warranty is the same except that it is LIMITED because you must pay to ship the product to the service shop or for the service technician's travel cost to your home.

All warranty service will be provided by our Factory Service Centers or by our authorized Customer Care® servicers during normal working hours.

Should your appliance need service, during warranty period or beyond, in the U.S.A. call 800.444.1845. Please have serial number and model number available when calling for service.

WHAT IS NOT COVERED

- Service trips to your home to teach you how to use the product.
- Improper installation, delivery or maintenance.
- Replacement of house fuses or resetting of circuit breakers.
- Failure of the product if it is abused, misused, or used for other than the intended purpose or used commercially.
- Damage to the product caused by accident, fire, floods or acts of God.
- Incidental or consequential damage caused by possible defects with this appliance.
- Damage caused after delivery.
- Product not accessible to provide required service.

EXCLUSION OF IMPLIED WARRANTIES—Your sole and exclusive remedy is product repair as provided in this Limited Warranty. Any implied warranties, including the implied warranties of merchantability or fitness for a particular purpose, are limited to one year or the shortest period allowed by law.

Some states/provinces do not allow the exclusion or limitation of incidental or consequential damages, so the above limitation or exclusion may not apply to you. This warranty gives you specific legal rights, and you may also have other rights which vary from state to state/province to province. To know what your legal rights are in your state/province, consult your local or state/provincial consumer affairs office or your state's Attorney General.

**Warrantor in USA: General Electric Company,
Louisville, KY 40225**

165D4700P333
49-55013

11-05 JR

Printed in the United States



GE Consumer & Industrial
Appliances
General Electric Company
Louisville, KY 40225
ge.com