

**JENN-AIR**



Use and Care Manual

**COMPACTOR**

MODEL TC407

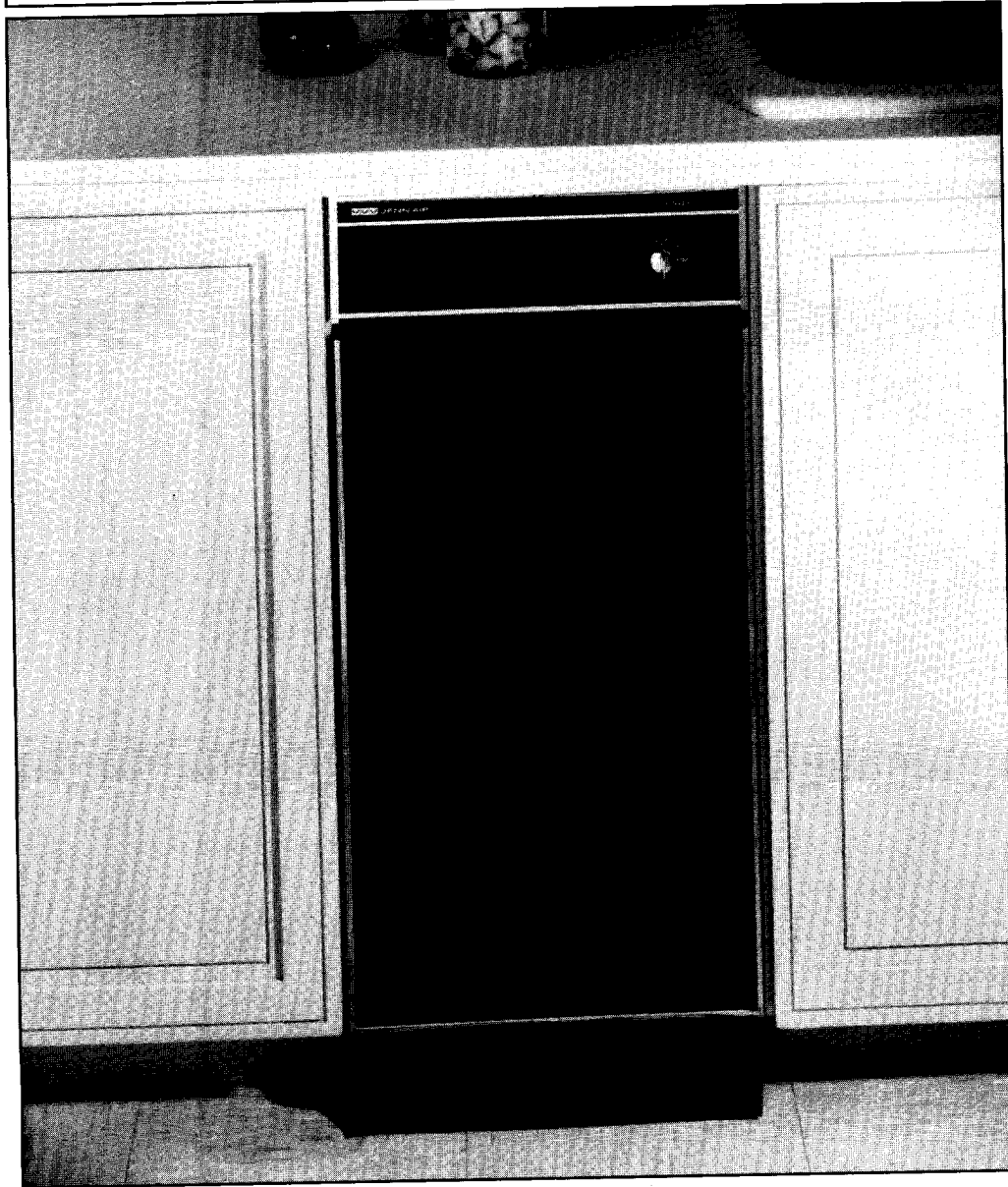

# Grounding Instructions

The compactor is for use on a single phase, 120-volt, 60 Hz, AC only 15 or 20 ampere fused and properly grounded circuit and is equipped with a grounding plug as shown above. Time delay fuse or circuit breaker is recommended. It is recommended that a separate circuit serving only this appliance be provided. For your personal safety, the compactor must be grounded. In the event of an electrical short circuit, grounding reduces the risk of electric shock by providing an escape wire for the electric current.

This appliance is equipped with a polarized 3-prong grounding plug. It must be plugged into a correctly polarized mating 3-prong grounding type outlet, properly installed and grounded in accordance with the National Electrical Code and local codes and ordinances. No adapter should be used with this appliance.

Polarized 3-prong  
grounding type  
outlet

3-Prong  
grounding  
plug

Power supply  
cord

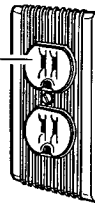

## **⚠ WARNING**

### **Electrical Shock Hazard**

**Do not modify the power supply plug provided with the compactor. If it will not fit the outlet, or if you are in doubt as to whether the wall outlet is properly grounded, check with a qualified electrician.**

**Failure to do so could result in electric or personal injury.**

# IMPORTANT SAFETY INSTRUCTIONS

## **⚠ WARNING**

**To reduce the risk of fire, electric shock, or injury to persons when using your compactor, follow basic precautions, including the following:**

- Read all instructions before using the compactor.
- Close supervision of children is necessary when the compactor is used near children.
- Do not allow compactor to be used as a toy, or to run unattended at any time. Lock key switch when not in use and store key out of reach of children.
- Do not touch moving parts.
- Have appliance examined, repaired or adjusted by an authorized serviceman.
- Do not compact:
  - lighted cigarettes, cigars or other hot or burning items.
  - any container or aerosol can containing insecticide, hair spray, paint, engine starting fluid or other poisonous, toxic, or explosive products.
  - volatile flammable material such as oily rags, thinner, etc., which would create a fire hazard.
- Do not take apart this appliance. Incorrect reassembly can cause electric shock when subsequently used.
- Use only for intended use as described in this manual. Do not use other than manufacturer's recommended attachments.
- Never lift the bag by the sides. Broken glass or other sharp objects in the bag can cause injury.
- This compactor is designed for household use only.

- Unplug compactor from electrical outlet before servicing.
- The compactor must be electrically grounded. See the grounding instructions.
- Do not overload trash bag with heavy material such as glass.
- Never operate the compactor if:
  - it is not working right.
  - it is damaged.
  - parts are missing.
  - the cord set, plug or motor is damaged in any manner.
- Never use or store flammable fluids (dry cleaning solvents, gasoline, kerosene, etc.) in or near your compactor. These substances give off vapors that can create a fire hazard or explosion.
- See Installation Instructions.

## SAVE THESE INSTRUCTIONS

### Additional Safety Instructions and Your Responsibilities

- Do not shove items down into the compactor with hands or feet. Let the compactor do the compacting.
- Always place glass bottles, etc., on their sides in the center of the drawer. The waste paper below and beside the bottle can help keep broken glass near center of bag.
- Do not use the compactor as a counter for electrical cooking appliances nor as a cutting board.
- Do not install or store compactor where it will be exposed to the weather.
- You are responsible for making sure that your compactor:
  - is used only for jobs normally expected of home compactors.
  - is properly installed and leveled on a floor that can support its weight.
- Do not set hot pans, etc., on the compactor top. Do not spill any liquids on the compactor top.

## About the Compactor

The compactor ram moves down inside the drawer and compresses waste material. The ram then moves back up into position and the compactor shuts off. A complete cycle takes about 27 seconds. As the bag fills, cycle time will decrease.

The compacting ram does not go to the drawer bottom. Only after the drawer is about one-third full will waste material be compacted.

When items such as glass are broken, loud noises will be heard. Strong glass bottles may not break at all. NOTE: Many glass bottles can be recycled.

The trash in a full compactor bag will be about one-fourth the size of its original bulk. More waste will be compacted if the compactor is run through a cycle after each time waste material is added and after bag is at least one-third full.

Since this manual explains how you can obtain the best use of your compactor, it is essential that you follow the instructions carefully. This will enable you to more fully enjoy and properly maintain your appliance.

Should you have any questions about your Jenn-Air appliance, please write to us.

**Consumer Relations Department**  
**Jenn-Air Company**  
 3035 Shadeland  
 Indianapolis, Indiana 46226-0901

# Parts of the Compactor

---

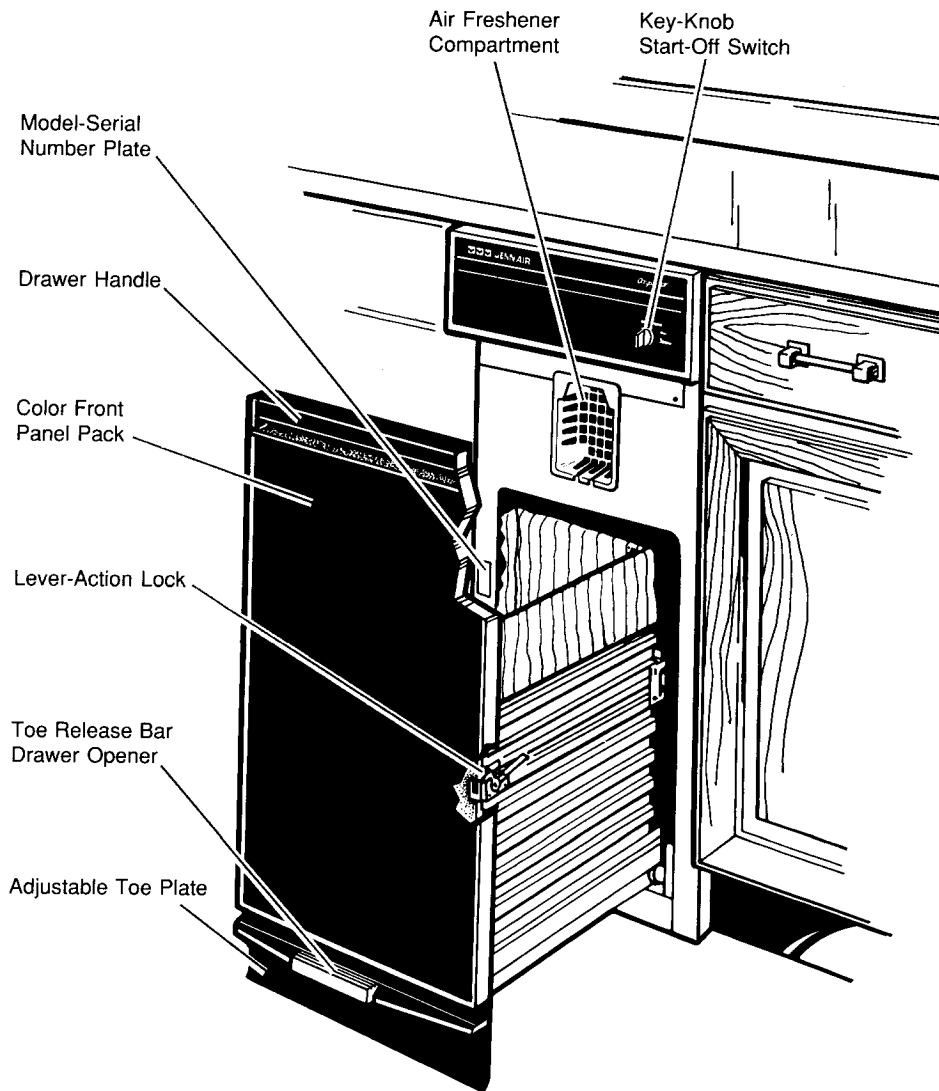

# Using the Compactor

---

## To Start

1. Open the drawer by pressing the toe release bar or pull handle.
2. Drop in the trash, folding or crushing oversized items. Make sure trash does not fall behind container. Never fill container beyond rim.
3. Close drawer completely or compactor will not operate..
4. Turn key-knob to START; let knob go. Compactor will automatically stop at the end of the cycle. When the compactor has stopped, the key-knob will remain at the ON position.

## To Stop

1. To stop compactor during a cycle, turn key-knob to LOCK/OFF. Then turn it to ON. The compacting ram will rise.
2. Once ram stops rising, drawer can be opened. Compactor is also ready for routine operation.

## To Lock

1. The compactor can be locked so that it cannot be operated. This is especially important to prevent small children from operating or playing with compactor.
2. To lock, turn key-knob to LOCK/OFF position, remove knob and place in a secure location. This locks the control panel but not the drawer. Therefore, before running the compactor, check to see if any item has been mistakenly placed in the drawer.

## Loading Tips

- The compactor is designed to handle most dry trash. However *it is not a substitute for a food waste disposer*. Most food waste will become sour and odoriferous when held at room temperature.
- Load bottles or cans on their sides in the *center* of the drawer.
- Wrap all wet or messy food waste in newspapers or paper towels to help absorb moisture.

## Do Not Compact The Following Items

- Highly flammable materials, such as paint or oil-filled rags and paint cans that might cause a concentration of explosive vapors and thus a fire hazard.
- Any container or aerosol can which might contain poisonous or explosive products.
- Items that may develop offensive odors such as raw meat, fish, citrus rinds, disposable diapers and personal hygiene items.

# Installing and Removing the Bag

## To Install New Bag

1. Fit the bag caddy in the drawer. (See Fig. A)
2. Place folded bag into drawer. Open bag and pull top edges over the drawer top.
3. Lock bag in place by pulling the 4 prepunched holes over the bag retainer buttons. Holes will expand over the buttons without harming the bag. (See Fig. B)

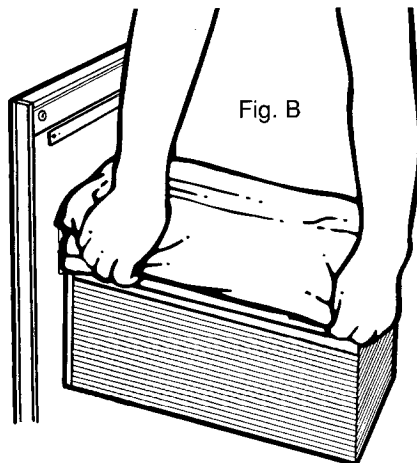
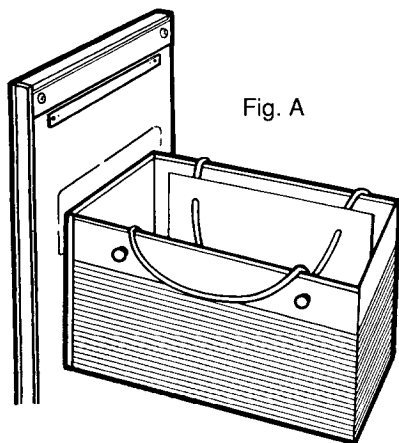

4. Press inside of bag against drawer bottom, sides and corners for a smooth fit. (See Fig. C)

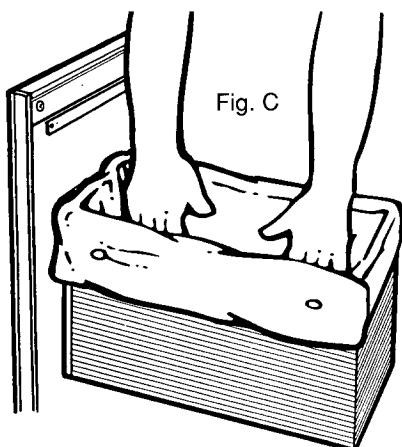

NOTE: Additional bags (Model No. TCB 12) may be purchased from Jenn-Air dealers. For more information regarding Trash Compactor bags, call 1-800-JENN-AIR (1-800-536-6247).

Use only Trash Compactor bags. DO NOT use grocery bags or other bags not designed especially for a compactor. These bags are neither strong enough nor large enough to hold compacted waste.

## To Remove a Filled Bag

1. Pull the drawer completely open.
2. Remove top of bag from bag retainer buttons. Pull up all 4 bag cuffs. (See Fig. D)
3. Close bags with twist ties provided. (See Fig. E)

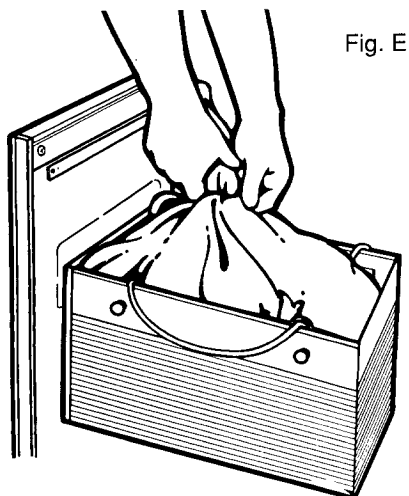
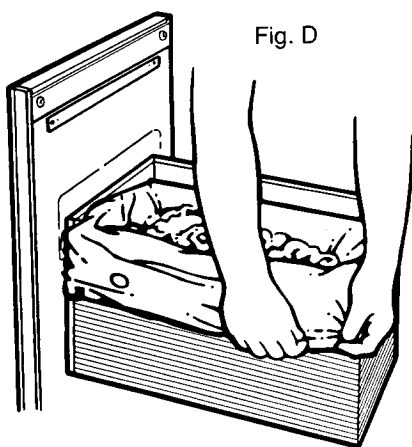

4. Push Side-Lock Latch down and tilt drawer side open. (See Fig. F)
5. Lift bag by bag carrier handles. (See Fig. G)

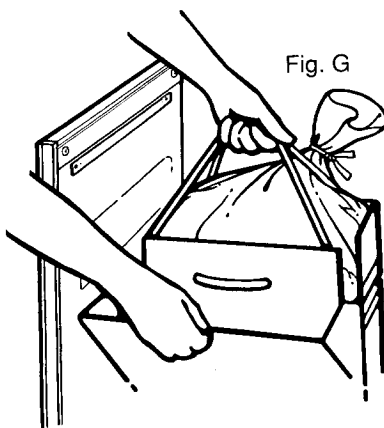
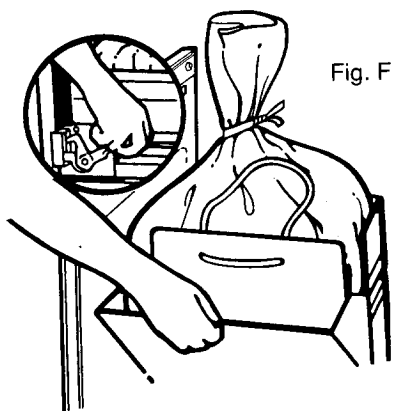

6. Push side of drawer to close. Lock the lever-action lock. Place clean bag in drawer.

# Other Hints on Caring for the Compactor

## Cleaning Compactor

**Exterior surfaces:** Wipe with warm, sudsy water and a damp cloth. Rinse. Dry with a soft cloth.

**Inside of drawer:** While cleaning inside of drawer, wear rubber gloves. There may be bits of glass in the drawer. Wash with a damp cloth using warm, sudsy water. Rinse and dry.

For ease in cleaning, the drawer side can be removed. Press down lever-action lock and tilt side of drawer; hold latch down until drawer clears. Lift out drawer side. (See Fig. H) To replace, slide it back in the tilted position. Press latch down and push side of drawer in upright position. Lock latch.

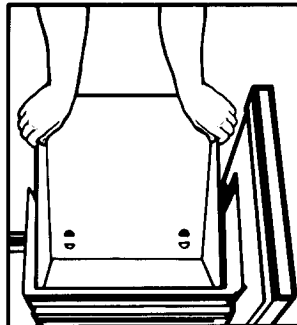

Fig. H

**Inside of cabinet.** Remove drawer by pulling it out until it stops. Note the tracks in which the drawer rollers move. Lift the drawer front to clear the drawer stops. Grasp drawer on the sides, as shown in Fig. I, and lift out of cabinet. Set aside.

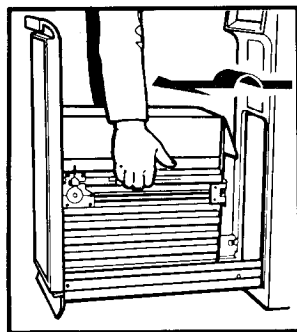

Fig. I

While drawer is out of cabinet, check the ram cover and clean if necessary. While wearing rubber gloves, wipe glass particles off ram cover with a cloth or paper towels. Use warm sudsy water to remove foods. Rinse and dry. (See Fig. J)

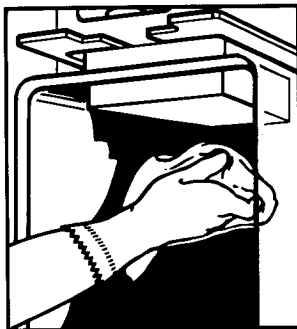

Fig. J

Vacuum inside of cabinet if necessary. While wearing rubber gloves, wash, rinse and dry cabinet interior.

To replace drawer, insert rollers into tracks. Lift drawer to clear stop tabs. Push in drawer.



## **Air Freshener**

Using an air freshener will help control odors that might develop in the trash. Place a solid air freshener, such as a stick-on disc shaped freshener, into the air freshener compartment. There are many solid air fresheners available at supermarkets and department stores. The air freshener should last 4 to 6 weeks depending on room temperature and how dry room air is.

Compartment that holds air freshener can be removed for cleaning if necessary.

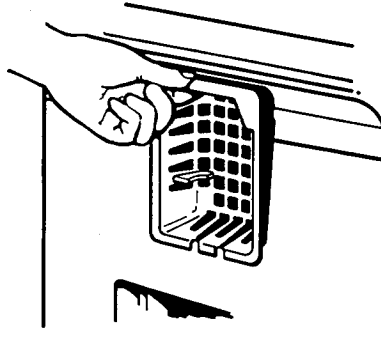

## **Adjustable Toe Plate**

In some installations the toe plate may rub the floor covering. If this occurs, the toe plate clearance may be changed as follows:

- Determine the amount of interference of the toe plate with the carpet or flooring.
- Slide the drawer from the unit.
- Lay drawer bottom up.
- With a ruler and pencil draw a line where toe plate interferes with the floor covering.
- Use a pair of scissors and cut toe plate along this line.
- Replace drawer in the unit.

# Changing Front Panels

Your Jenn-Air Model TC407B compactor comes equipped with two reversible front panels painted Black/White and Almond/Harvest Gold. To change the color of your compactor's front panel, follow the directions below. All you need is a medium sized screwdriver.

(NOTE: Your Model TC407W compactor comes equipped with only one reversible front panel painted Black/White.)

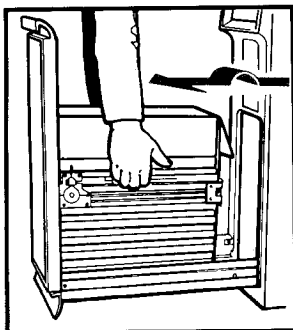
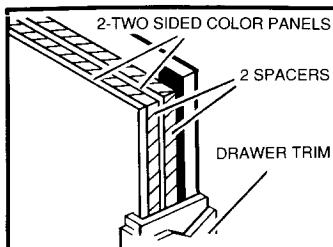

- Slide drawer out until it stops.
- Lift front to clear stops.
- Pull straight out.

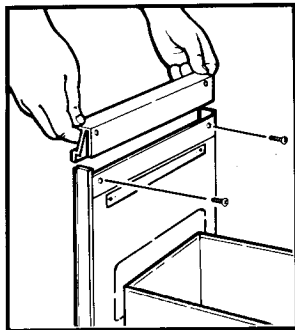

- Remove two screws shown.
- Remove handle.

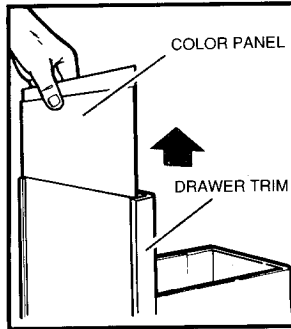

- Remove the color panel you want.
- Be careful—edges may be sharp.

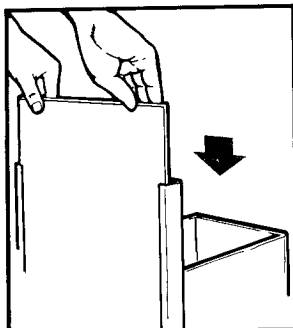

- Install desired color panel in front, behind drawer trim.
- Reinstall the remaining color panel between spacers.
- Make sure panels are all the way down.
- Replace handle and screws.

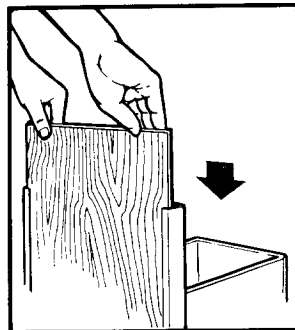

Option: Match your kitchen's color scheme by replacing your color panel with your own creation (wallpaper, paneling). See "Installation Instructions."

- Replace the drawer:
  - Put drawer rollers over stops in the drawer guides.
  - Slide drawer back to stops.
  - Lift front of drawer to clear stops.
  - Slide it all the way in.

## **⚠ WARNING**

**REPLACE HANDLE BEFORE OPERATING COMPACTOR TO AVOID INJURY FROM MOVING PARTS.**

# Before You Call For Service

---

Check the following list to be sure a service call is really necessary. A quick reference of this manual, as well as reviewing additional information on items to check, may prevent an unneeded service call.

## **If the compactor won't operate:**

- Have you checked the main fuse or circuit breaker box?
- Is the drawer completely closed?
- Is the key-knob turned all the way to START before it is released?
- Is the electric cord securely plugged in?

## **If compactor stops during operation:**

- Push drawer in while turning key-knob to START. Repeat if necessary. Rearrange trash load – do not load rigid items at front of drawer.

## **Trash not compacted:**

- Drawer must be at least 1/3 full to see compaction.

## **Not enough compaction or force:**

- Compacting works best when only a few items are loaded. Use the compacting cycle frequently.

## **Bottles don't break:**

- Not all bottles will break every time, depending upon trash load below them.

## **Drawer won't open:**

- Drawer will open only when ram is all the way up.
- To raise the ram, push drawer in firmly; turn key-knob to START; release key-knob.
- Open drawer; lay cans and bottles flat in center of drawer.
- Start compactor again.

## **If You Need Service**

- Call the dealer from whom your appliance was purchased or the authorized Jenn-Air Service Contractor listed in the Yellow Pages. Your Jenn-Air Service Contractor can provide better and faster service if you can accurately describe problems and give the model and serial number of your appliance. Be sure to retain proof of purchase to verify warranty status. Refer to WARRANTY for further information on owner's responsibilities for warranty service.
- If the dealer or service company cannot resolve the problem, write to MAYCOR Parts and Service Co., P.O. Box 2370, Cleveland, TN 37320-2370, 615-472-3333.
- Use and care manuals, service manuals, and parts catalogs are available from MAYCOR for a nominal charge.

All specifications subject to change by manufacturer without notice.