

This Owner's Manual is provided and hosted by [Appliance Factory Parts](http://ApplianceFactoryParts.com).



GE JE1340WY02 Owner's Manual

[Shop genuine replacement parts for GE JE1340WY02](#)

DOOR PARTS

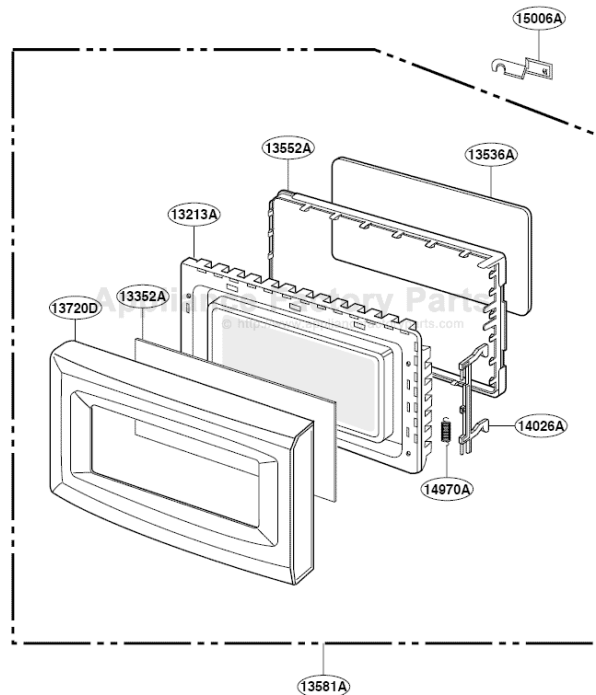

[Find Your GE Microwave Parts - Select From 3055 Models](#)

----- Manual continues below -----

DOOR PARTS

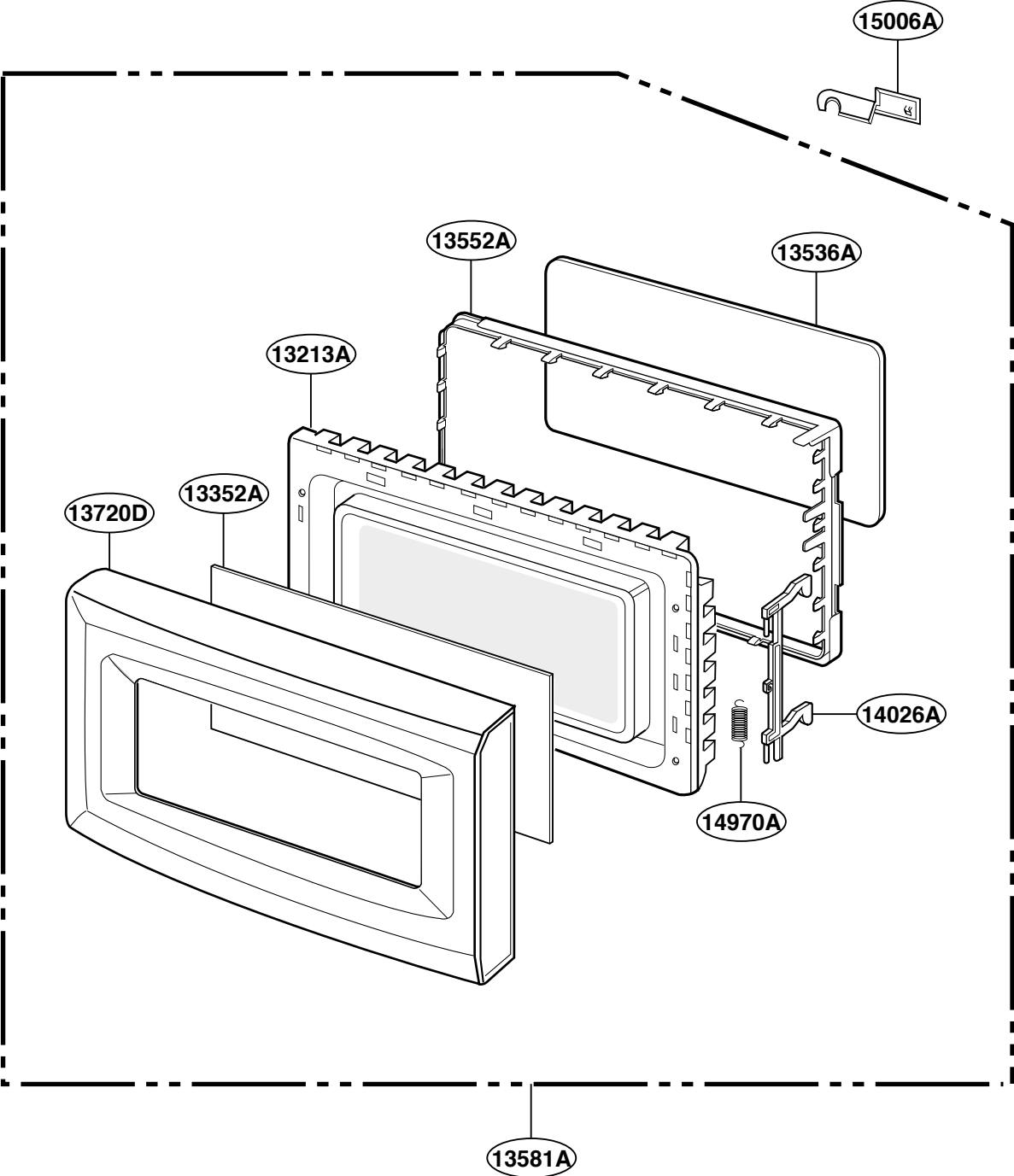

CONTROL PANEL PARTS

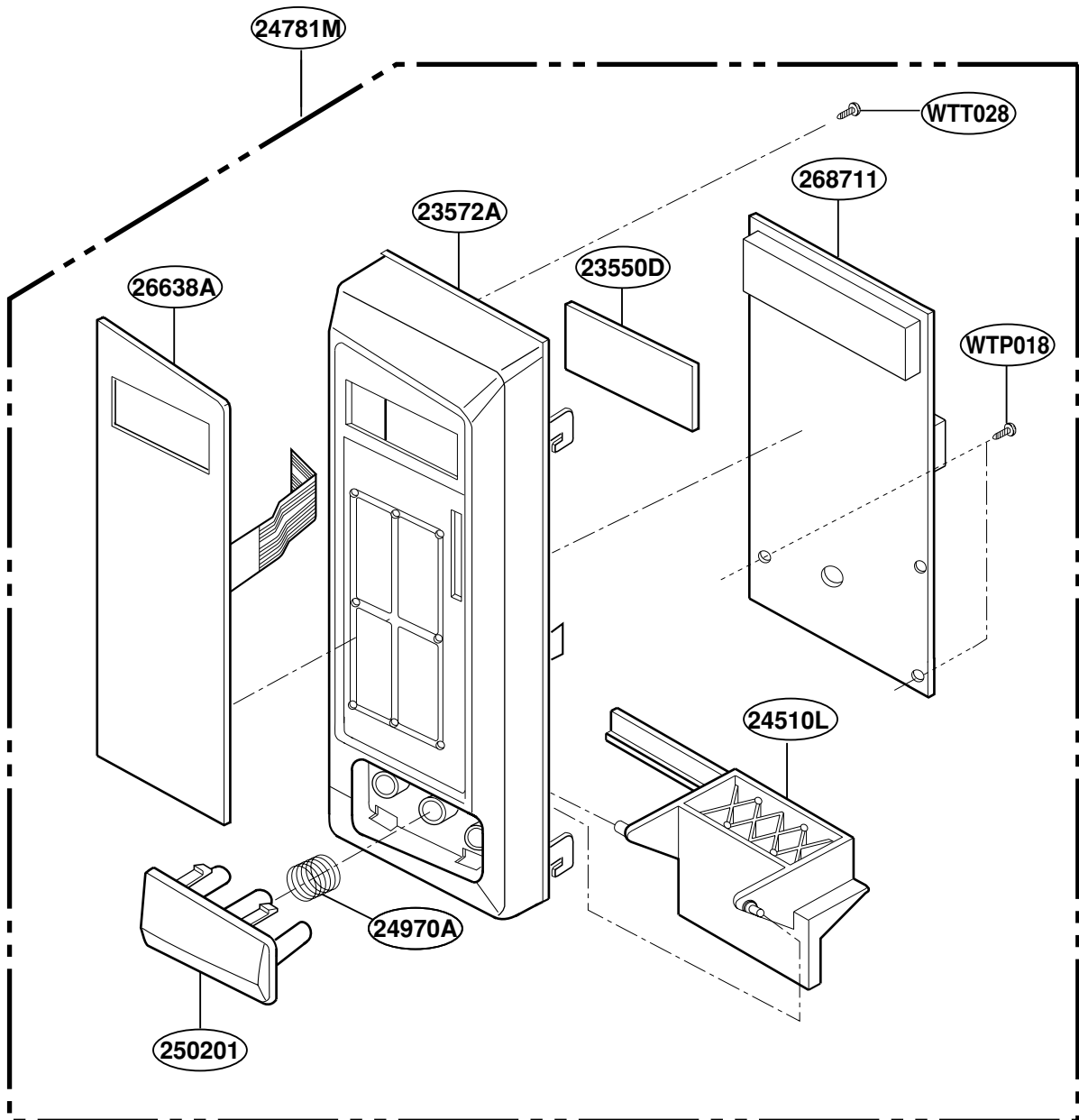

OVEN CAVITY PARTS

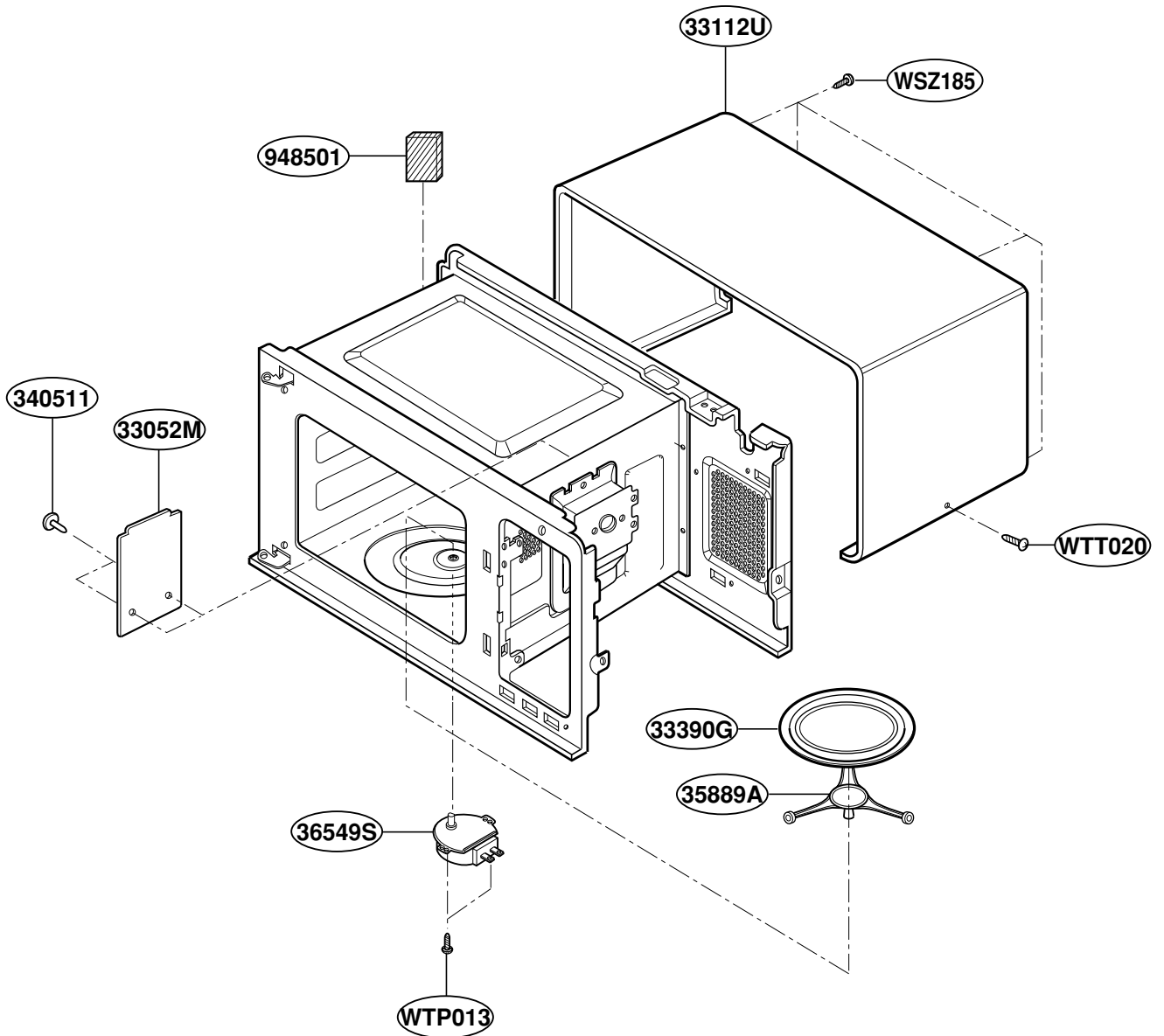

LATCH BOARD PARTS

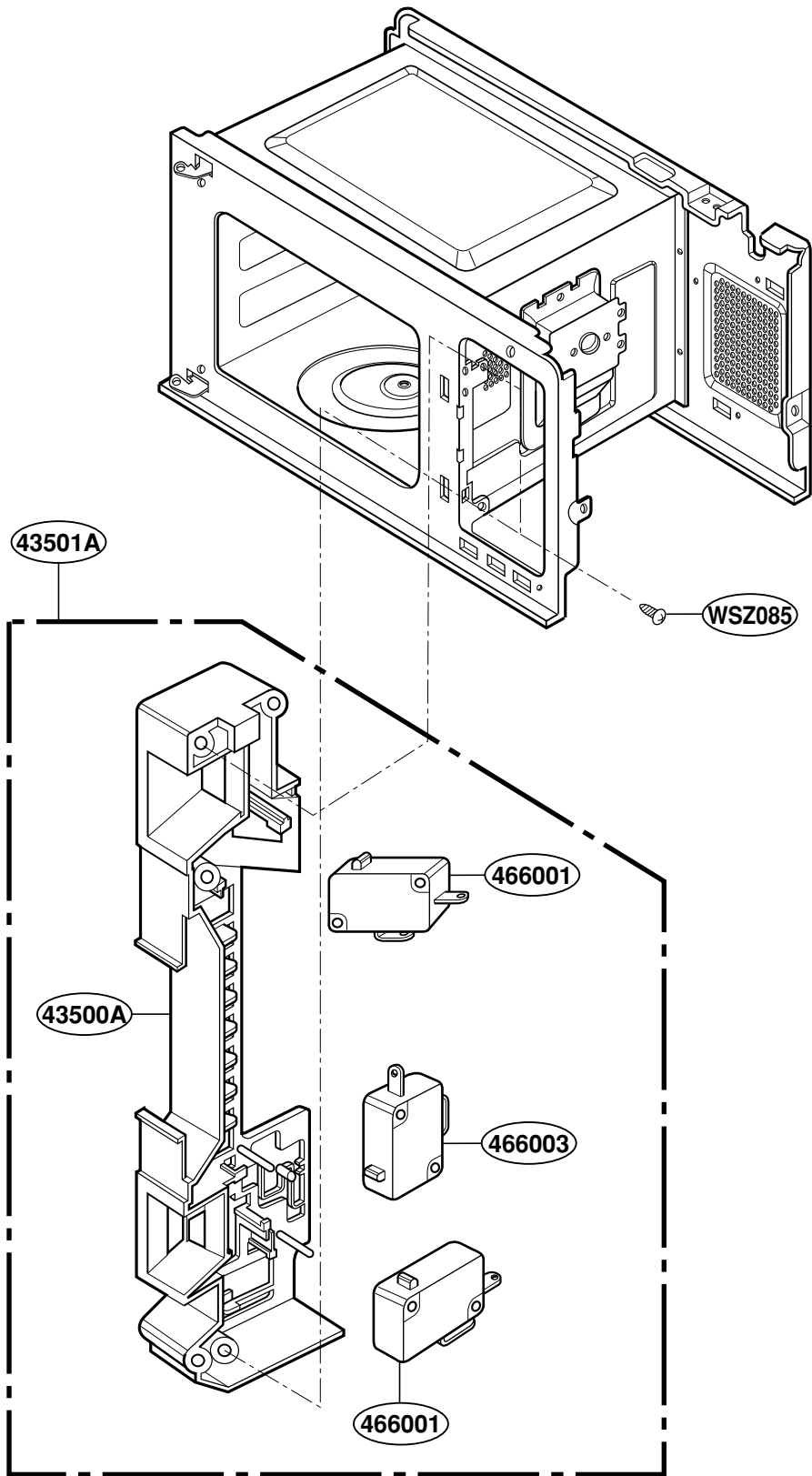

INTERIOR PARTS

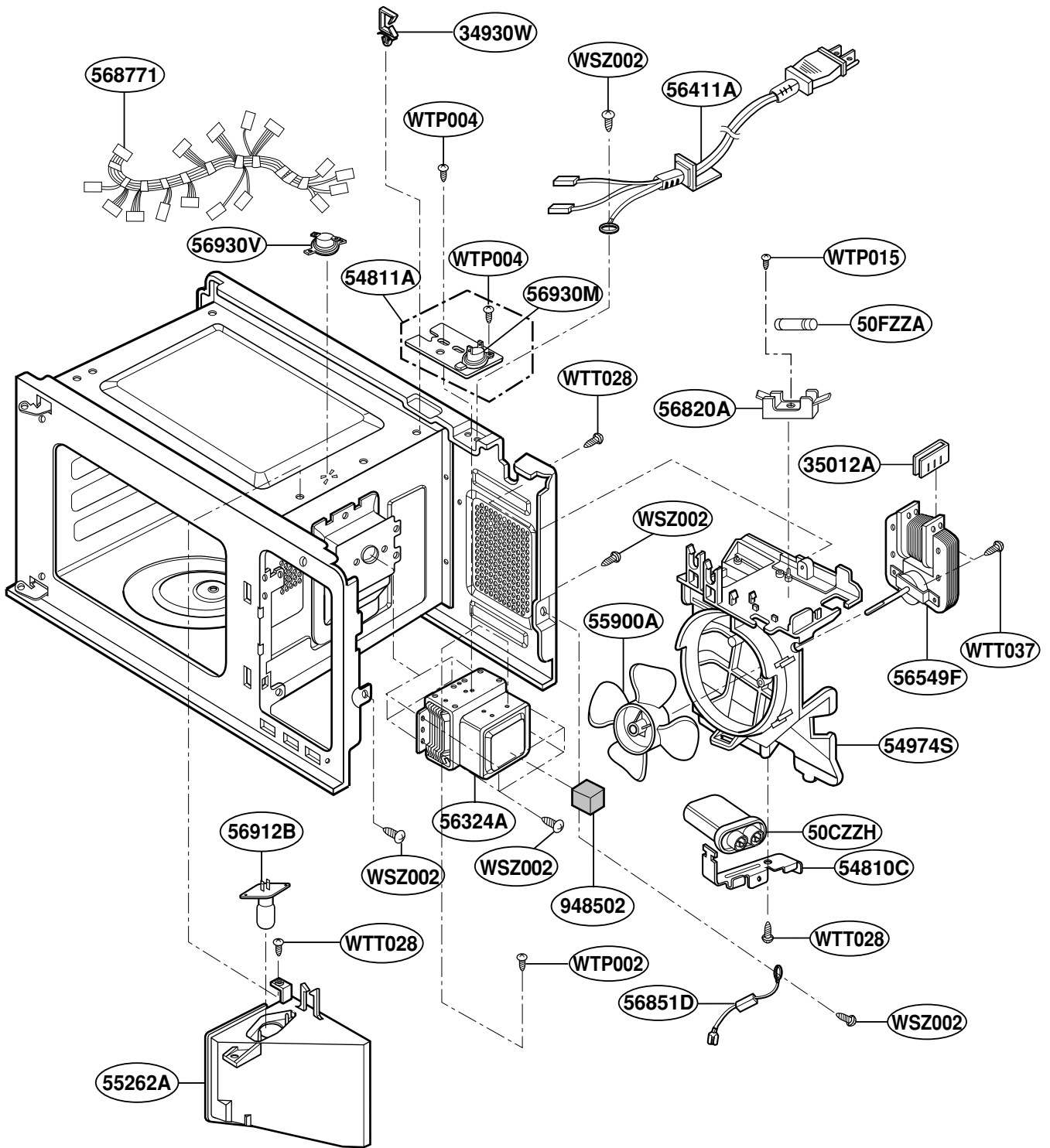

BASE PLATE PARTS

