

EXPLODED VIEW

INTRODUCTION

MODEL: JE1590

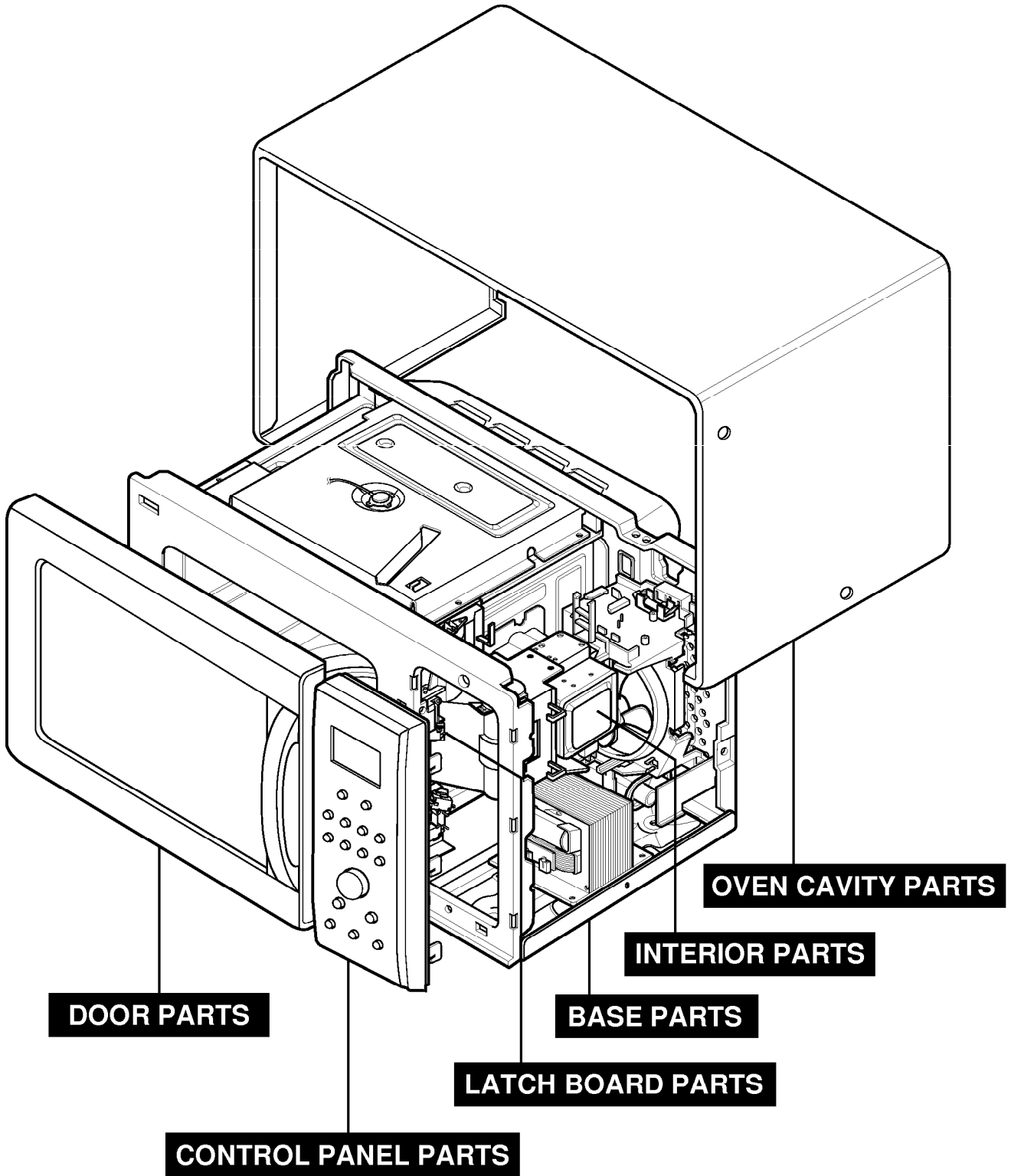

DOOR PARTS

MODEL: JE1590

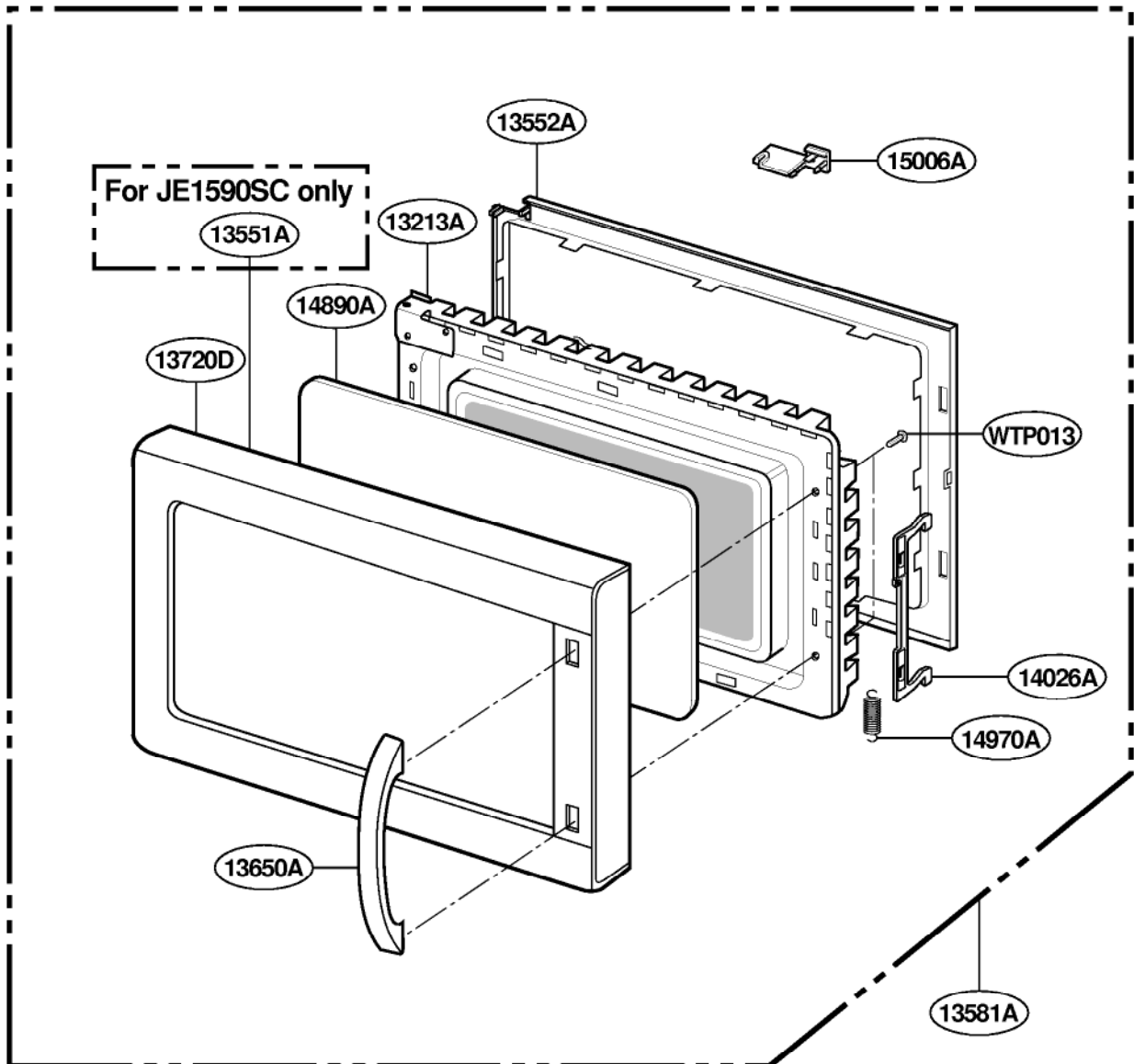

CONTROLLER PARTS

MODEL: JE1590

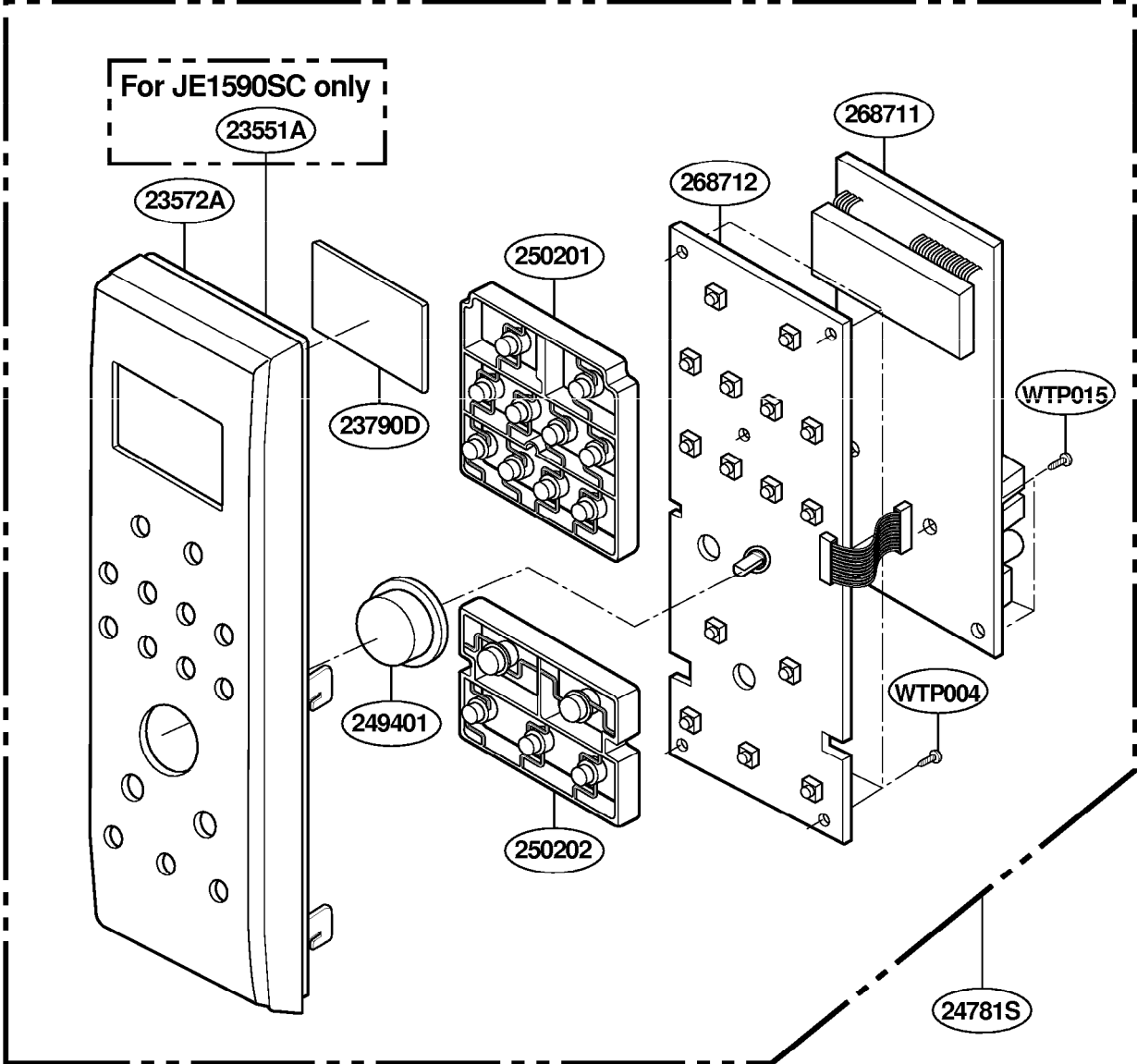

OVEN CAVITY PARTS

MODEL: JE1590

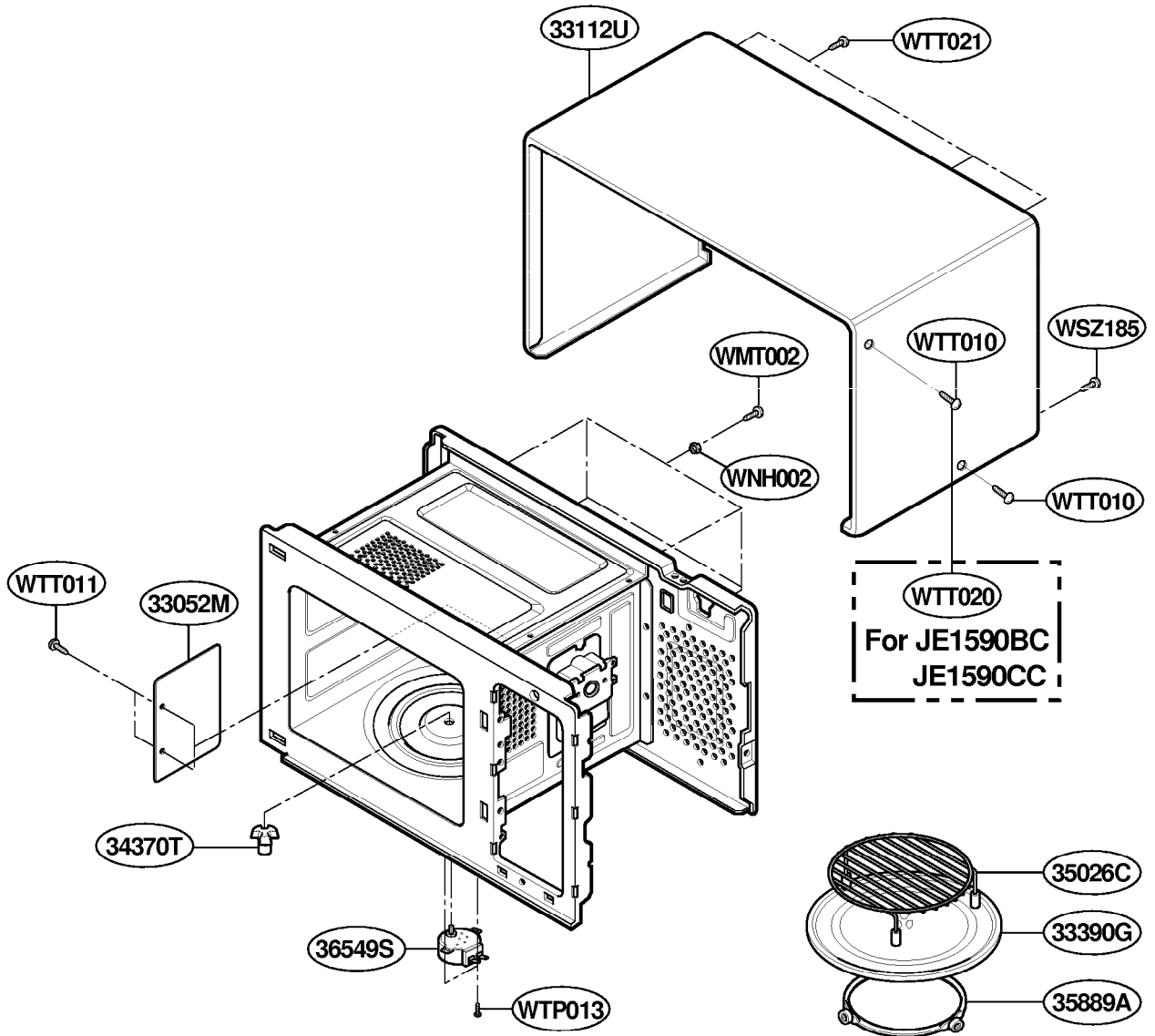

LATCH BOARD PARTS

MODEL: JE1590

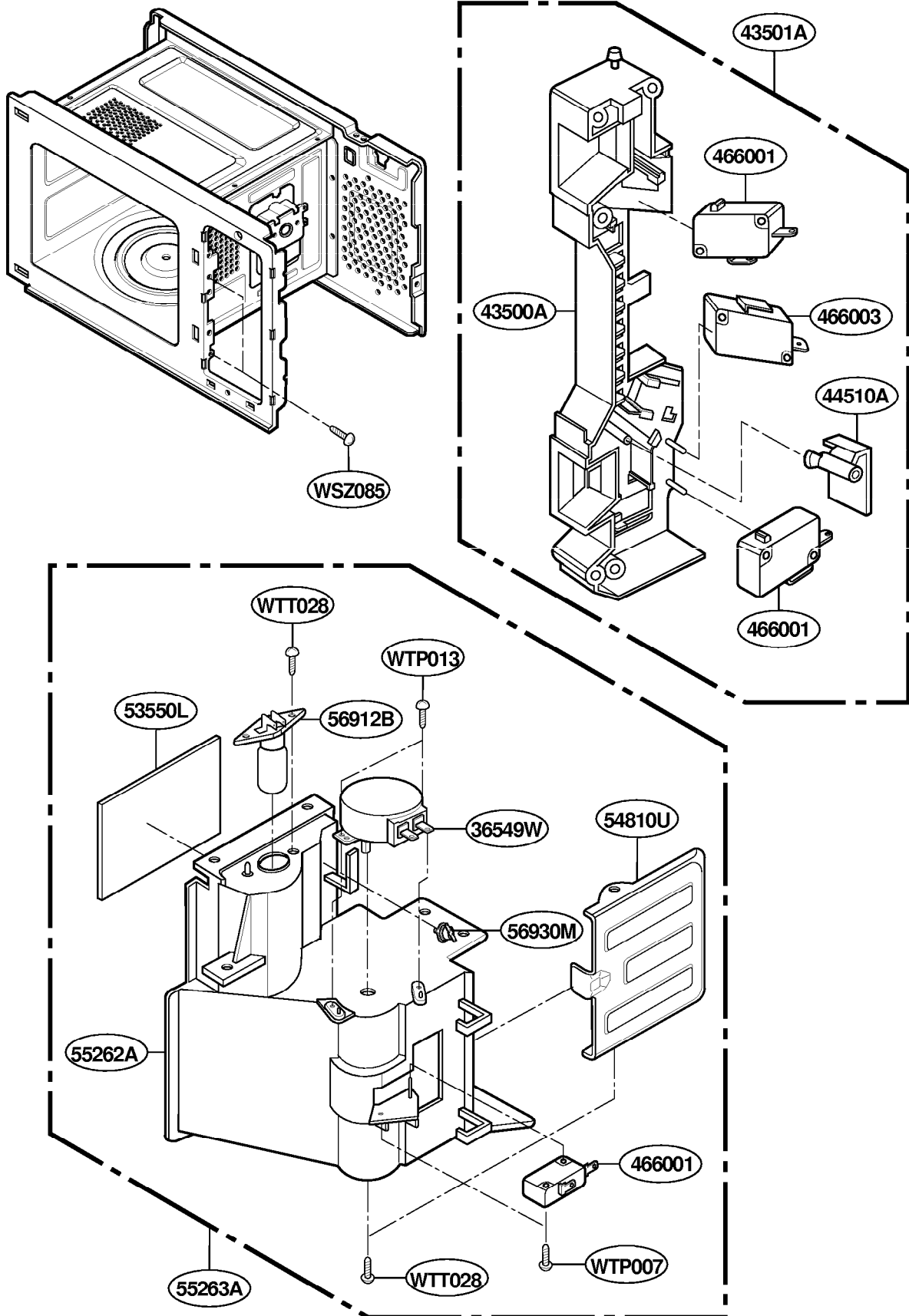

INTERIOR PARTS

MODEL: JE1590

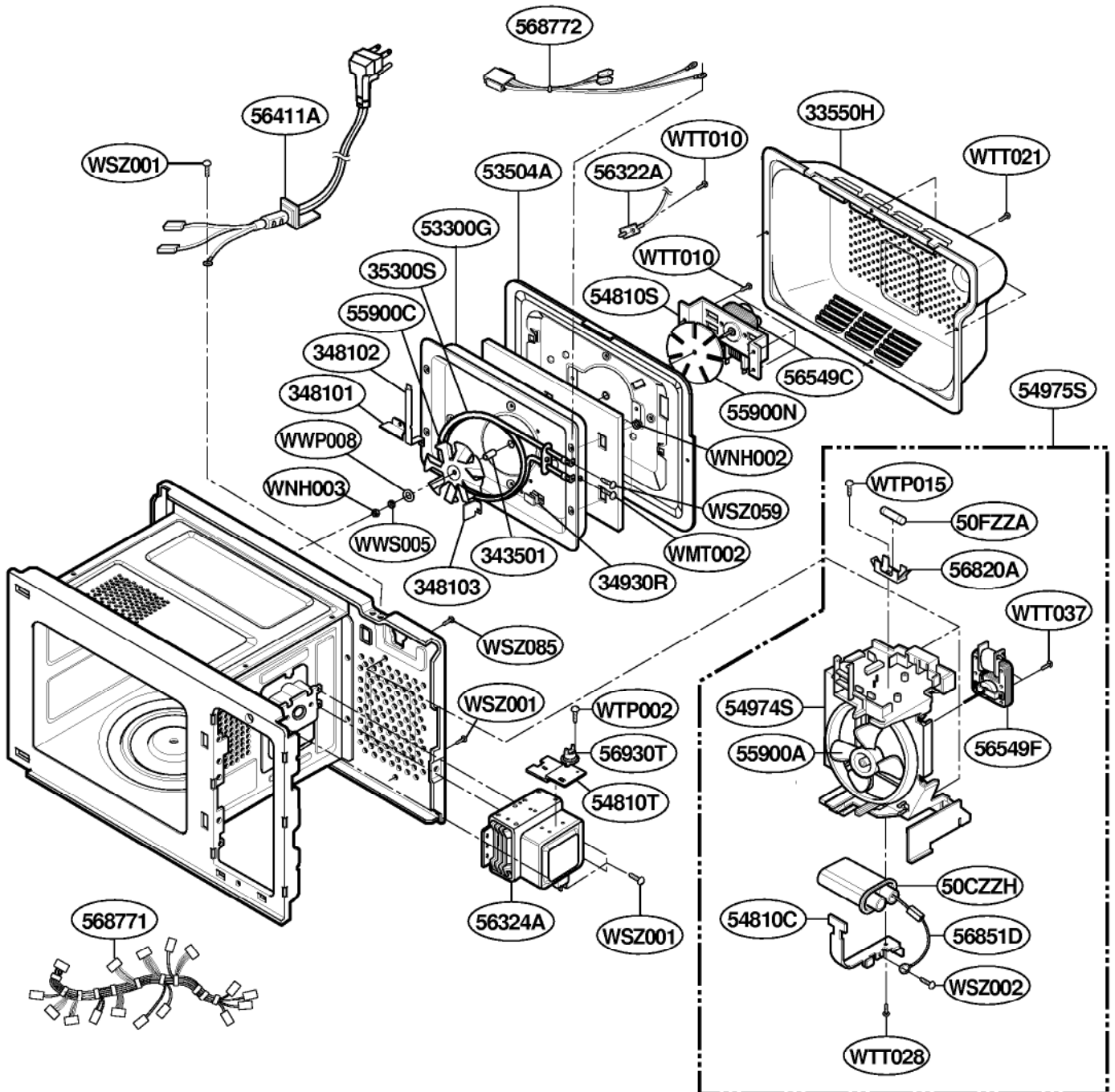

BASE PLATE PARTS

MODEL: JE1590

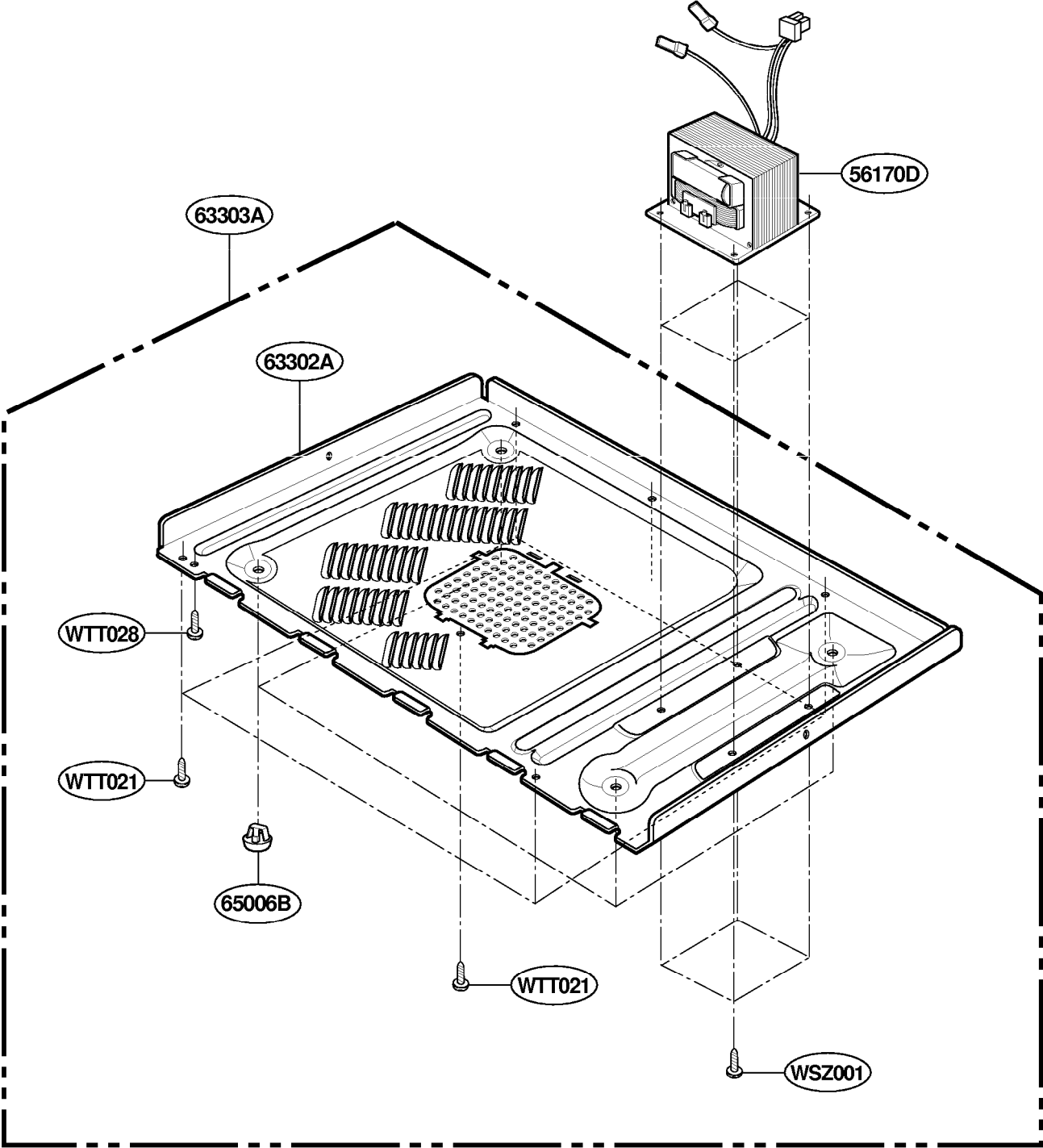

SENSOR PARTS

MODEL: JE1590

