

EXPLODED VIEW

INTRODUCTION

Model : JE1860WH / JE1860BH
JE1860CH / JE1860WB
JE1860GB / JE1860CB
JE1860SB / JE1860SH
JES1851GB / JES1851WB
JES1851AB / JES1851SB

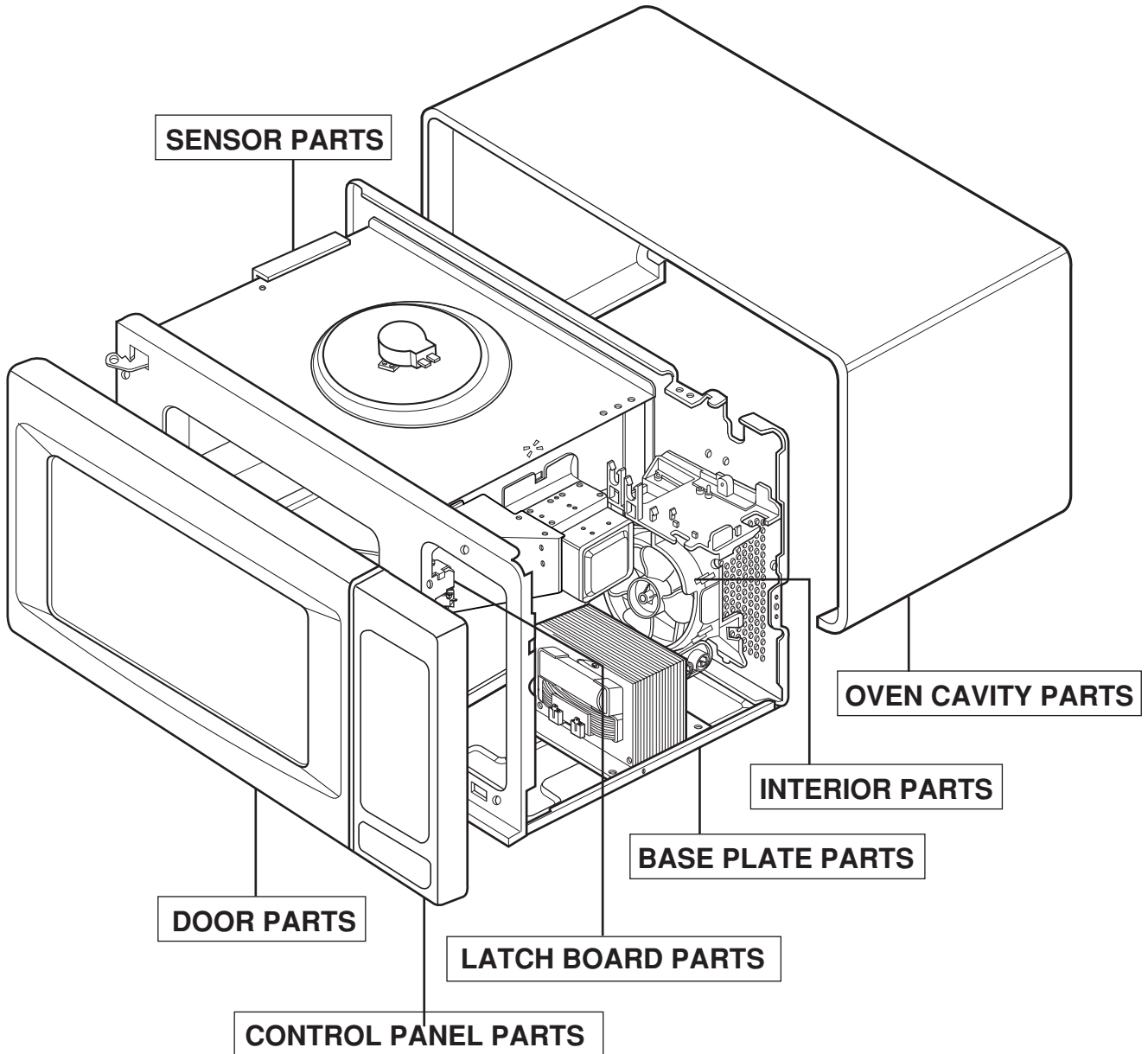

DOOR PARTS

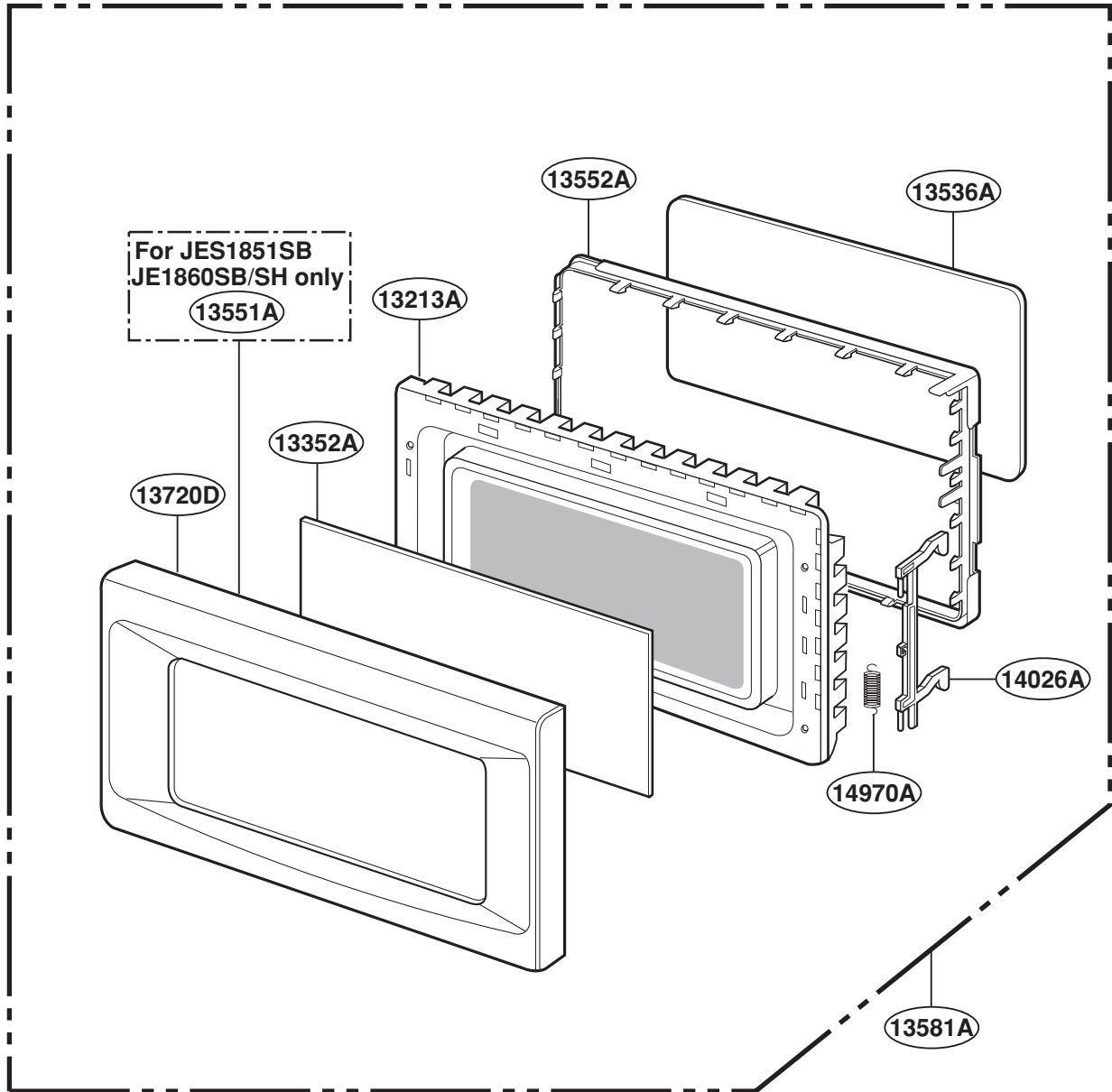

CONTROL PANEL PARTS

For Model : JE1860WH
JE1860BH
JE1860CH
JE1860WB
JE1860GB
JE1860CB
JES1851GB
JES1851WB
JES1851AB

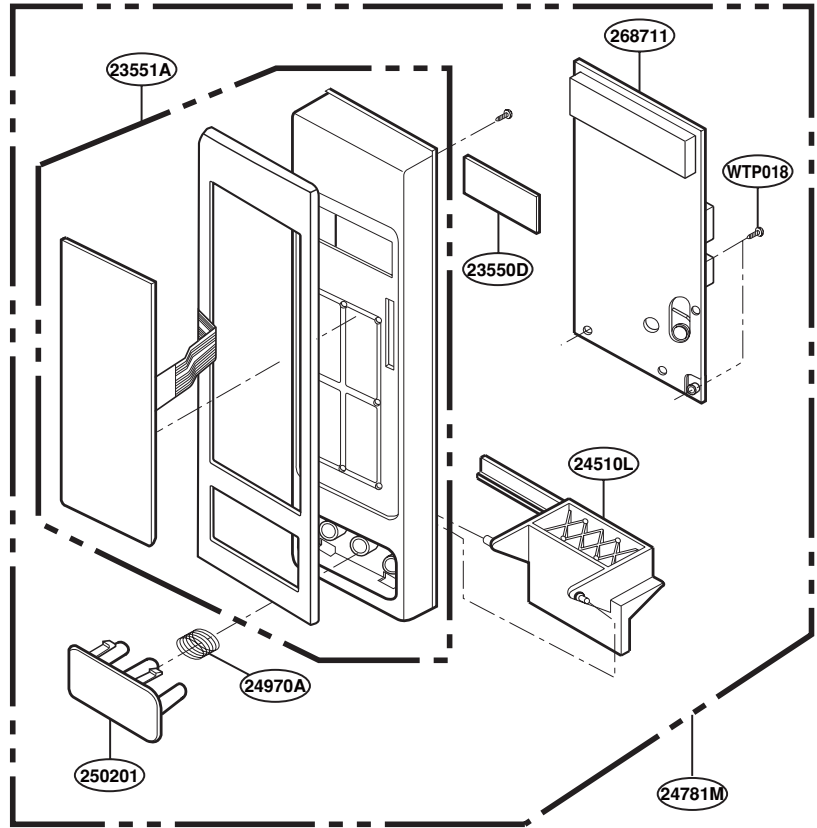

For Model : JE1860SB
JE1860SH
JES1851SB

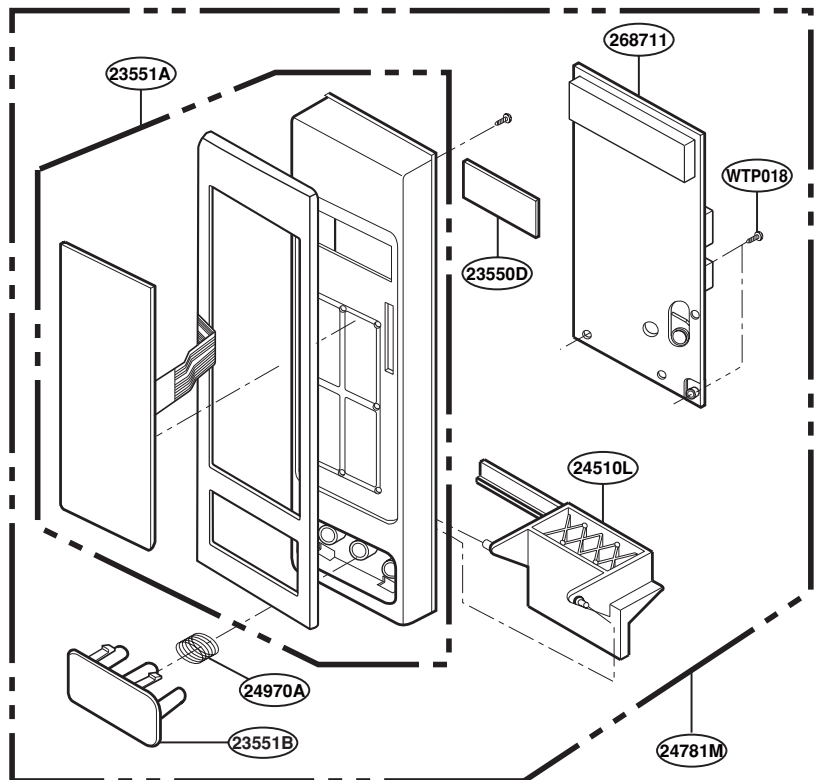

OVEN CAVITY PARTS

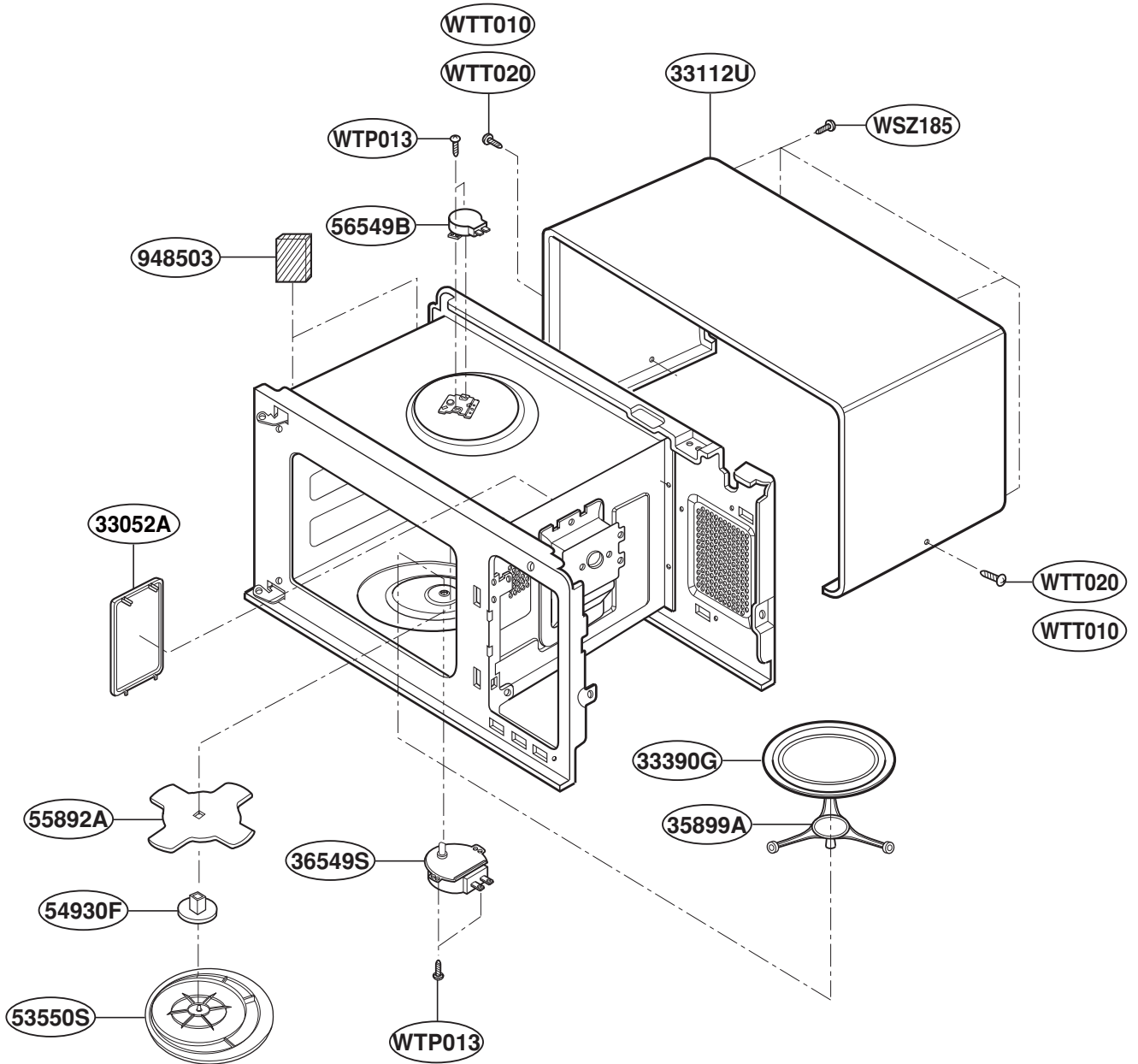

LATCH BOARD PARTS

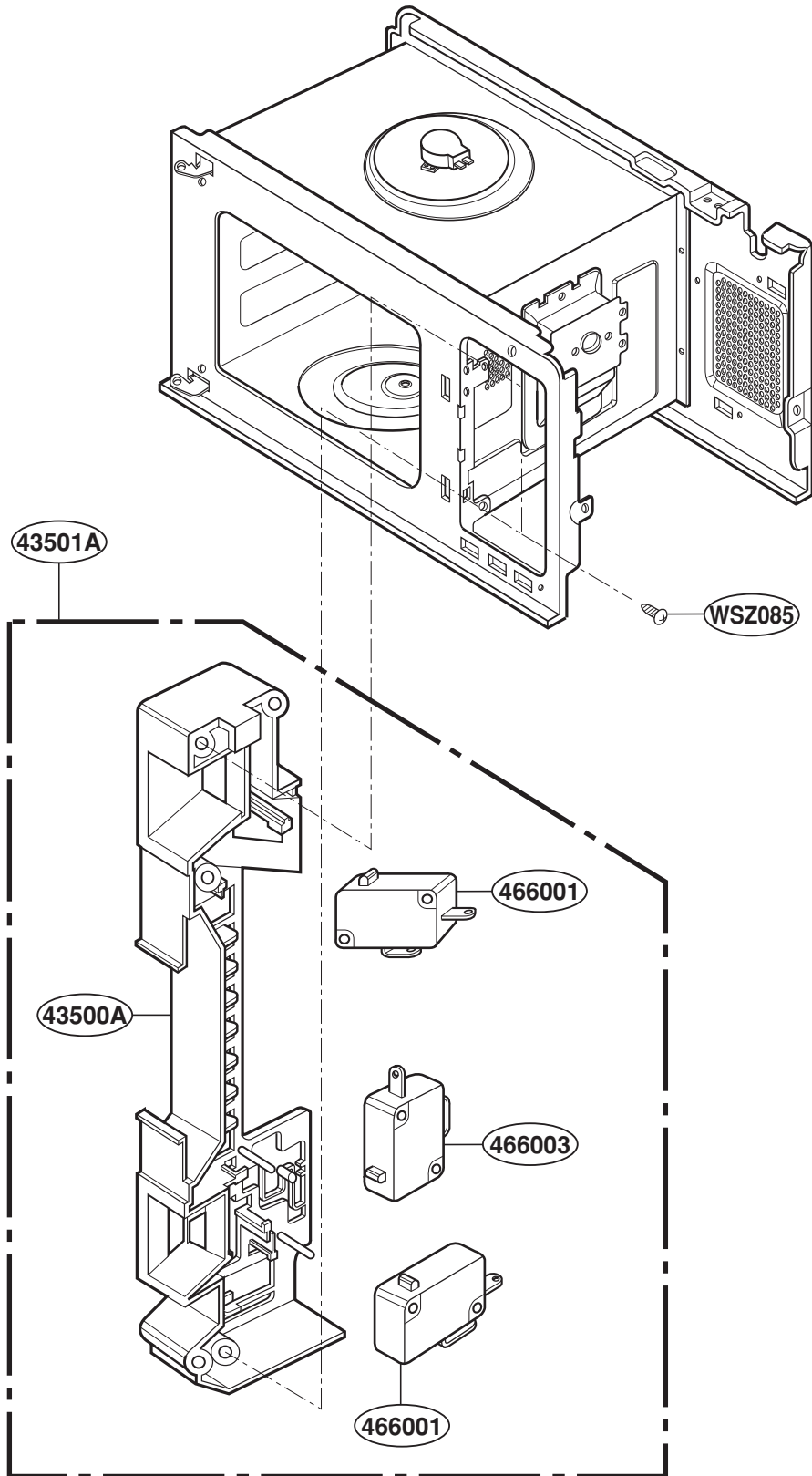

INTERIOR PARTS

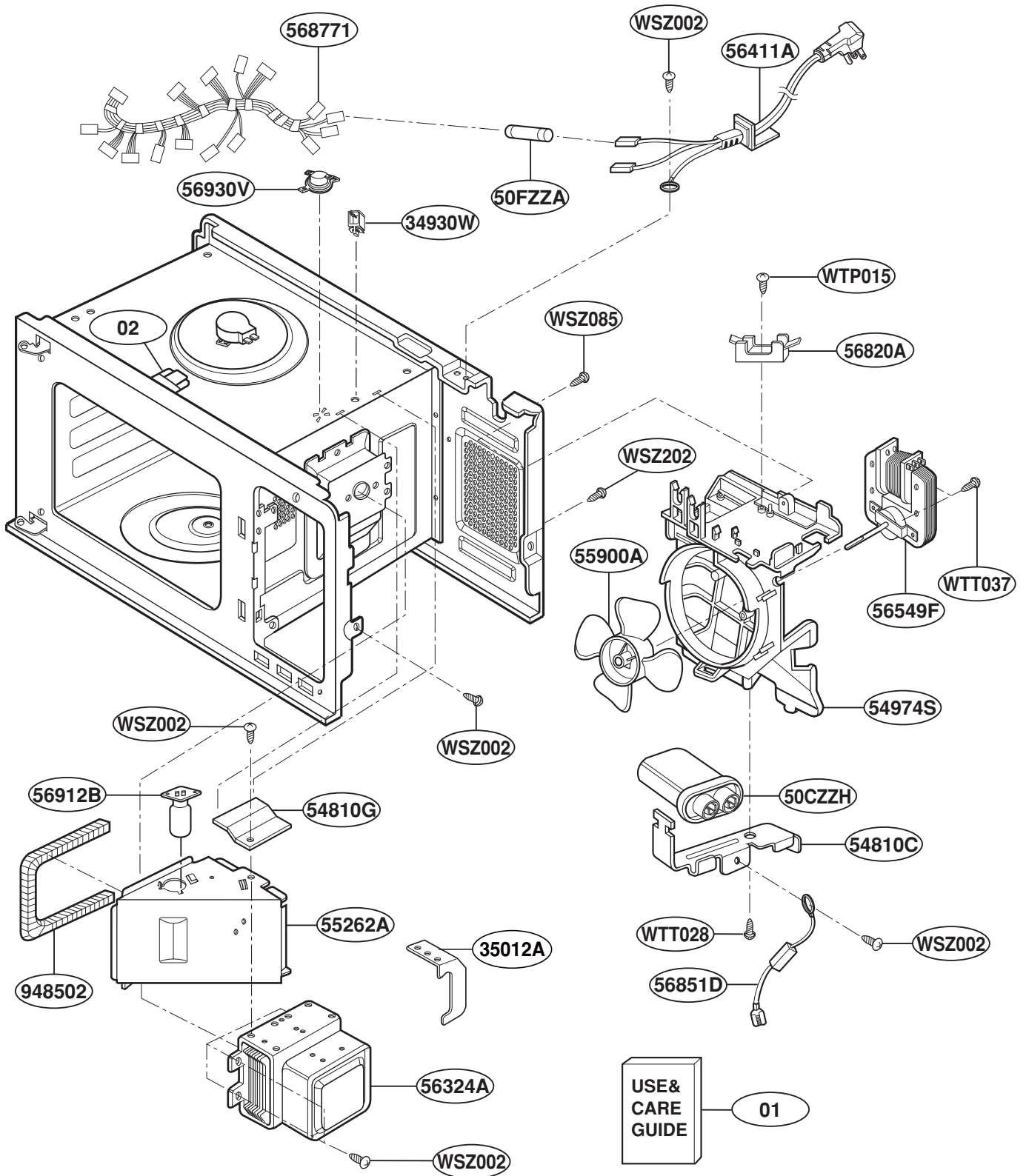

BASE PLATE PARTS

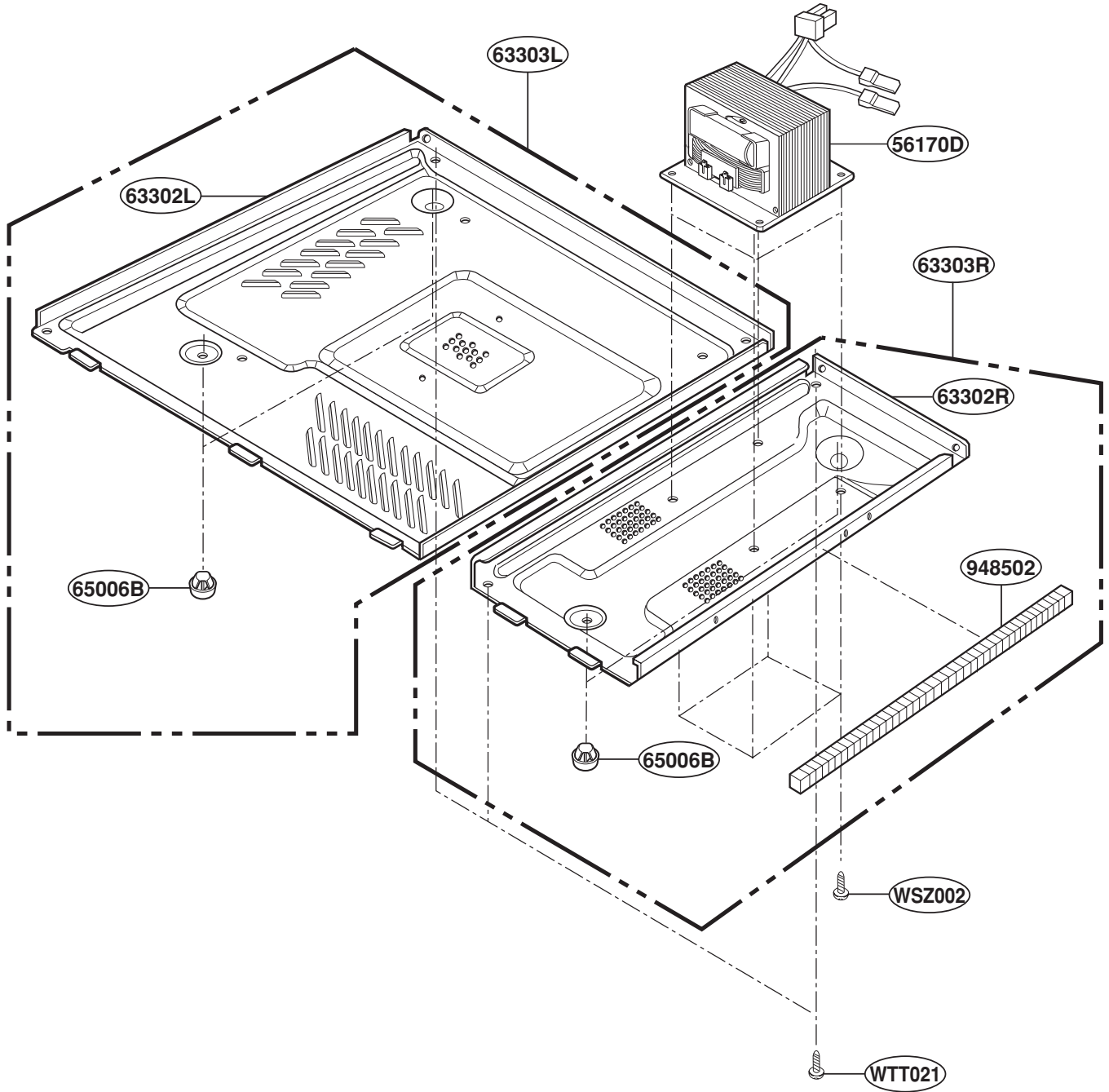

SENSOR PARTS

