

This Owner's Manual is provided and hosted by [Appliance Factory Parts](#).



GE JE1860WB001 Owner's Manual

[Shop genuine replacement parts for GE JE1860WB001](#)



[Find Your GE Microwave Parts - Select From 3055 Models](#)

----- Manual continues below -----

EXPLODED VIEW

INTRODUCTION

Model : JE1860WH / JE1860BH
JE1860CH / JE1860WB
JE1860GB / JE1860CB
JE1860SB / JE1860SH
JES1851GB / JES1851WB
JES1851AB / JES1851SB

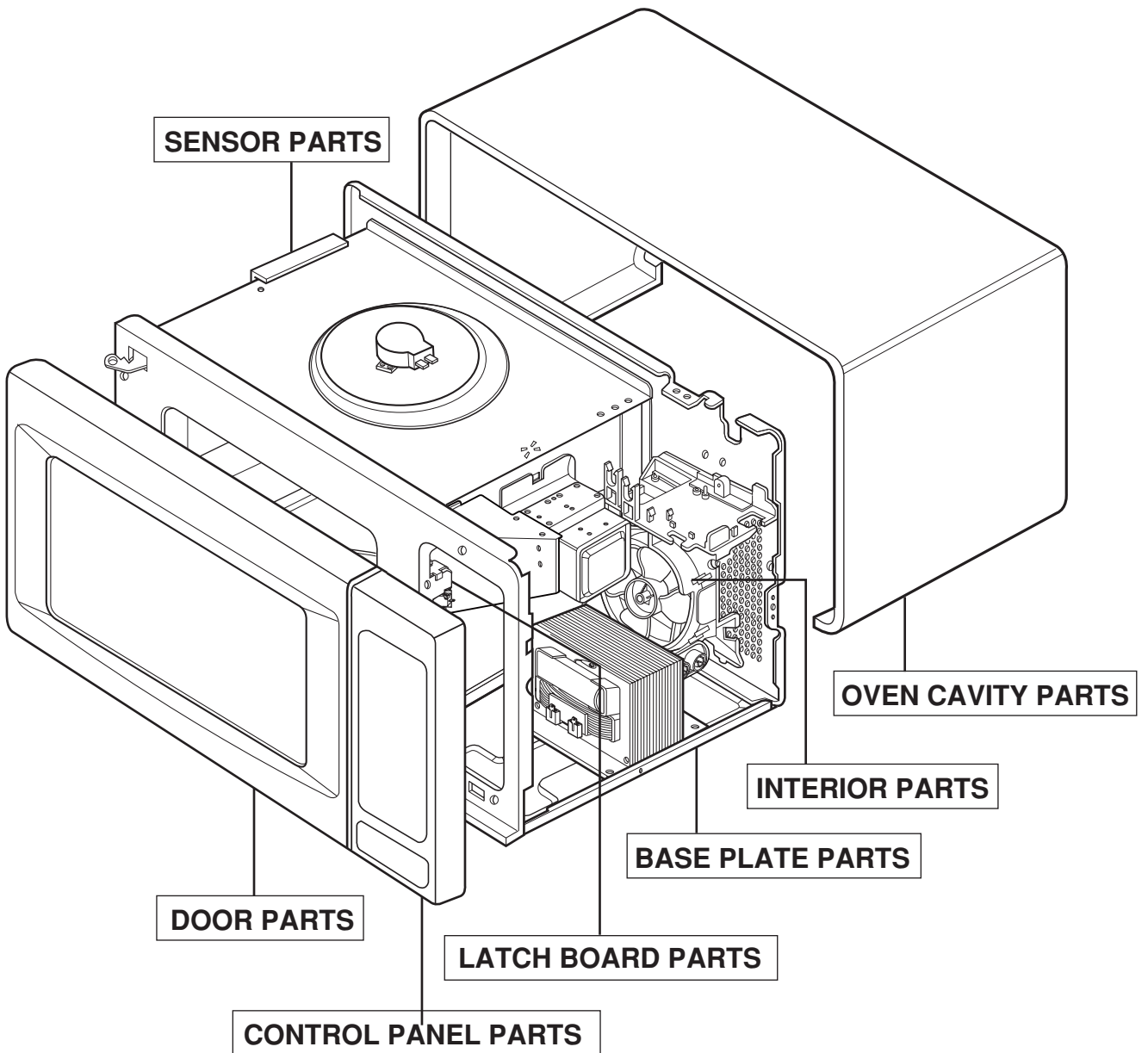

DOOR PARTS

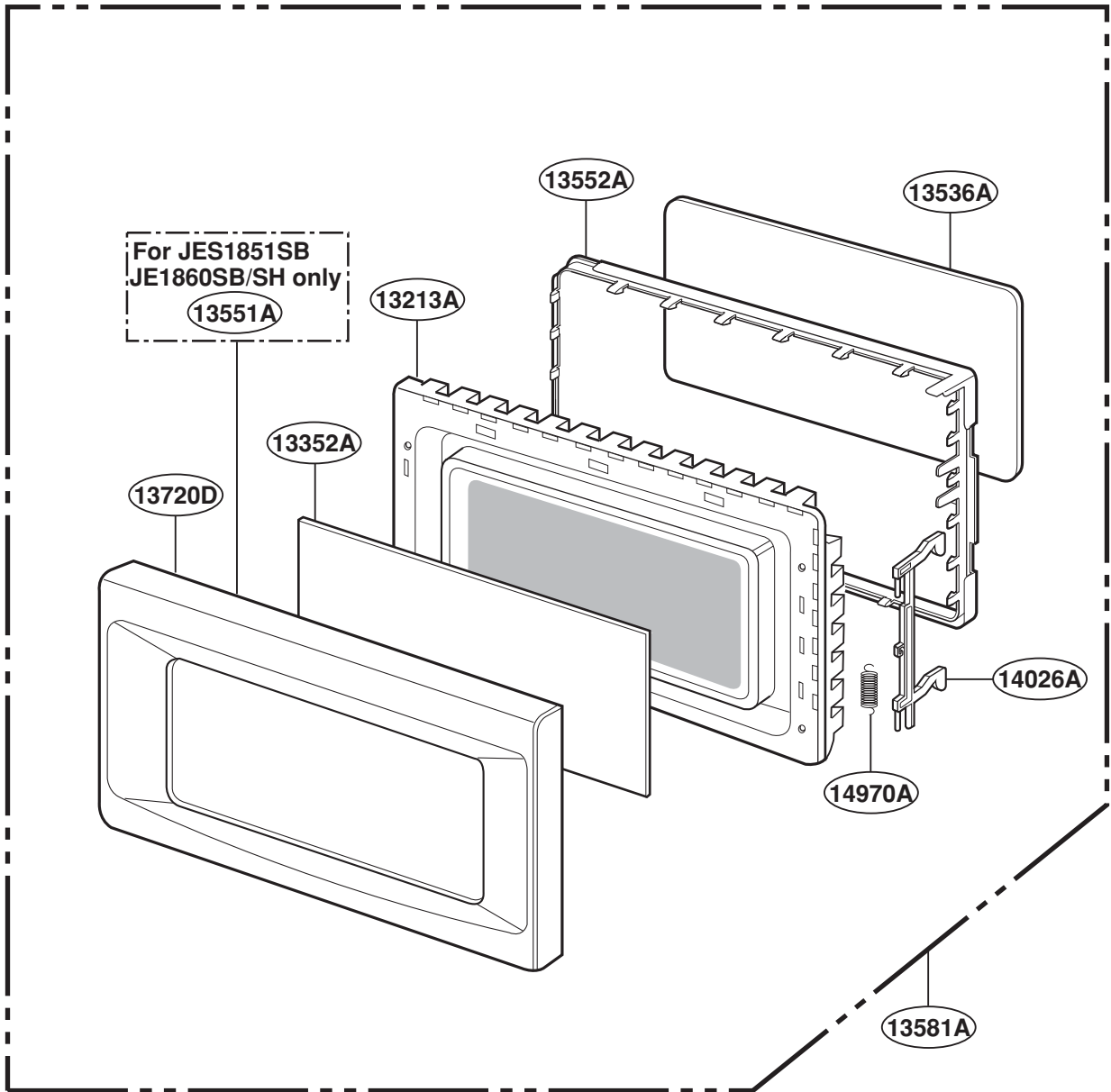

CONTROL PANEL PARTS

For Model :

- JE1860WH
- JE1860BH
- JE1860CH
- JE1860WB
- JE1860GB
- JE1860CB
- JES1851GB
- JES1851WB
- JES1851AB

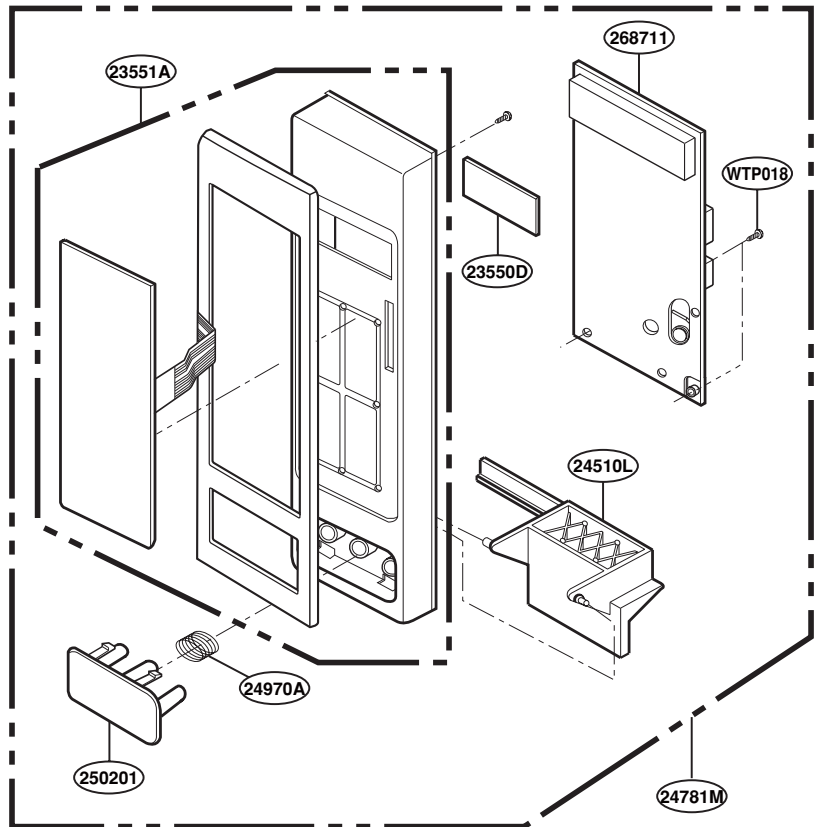

For Model :

- JE1860SB
- JE1860SH
- JES1851SB

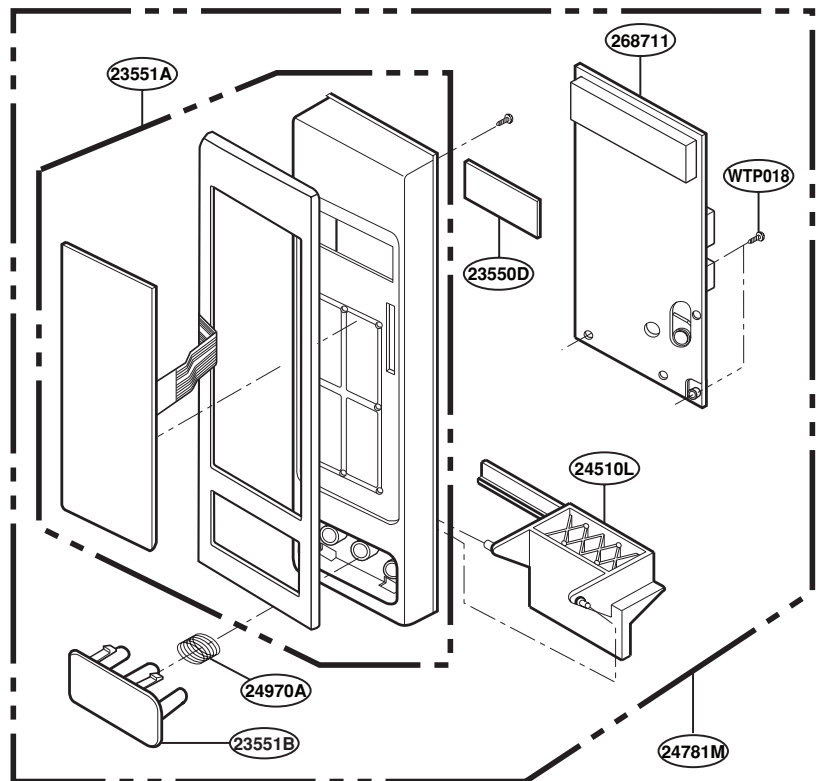

OVEN CAVITY PARTS

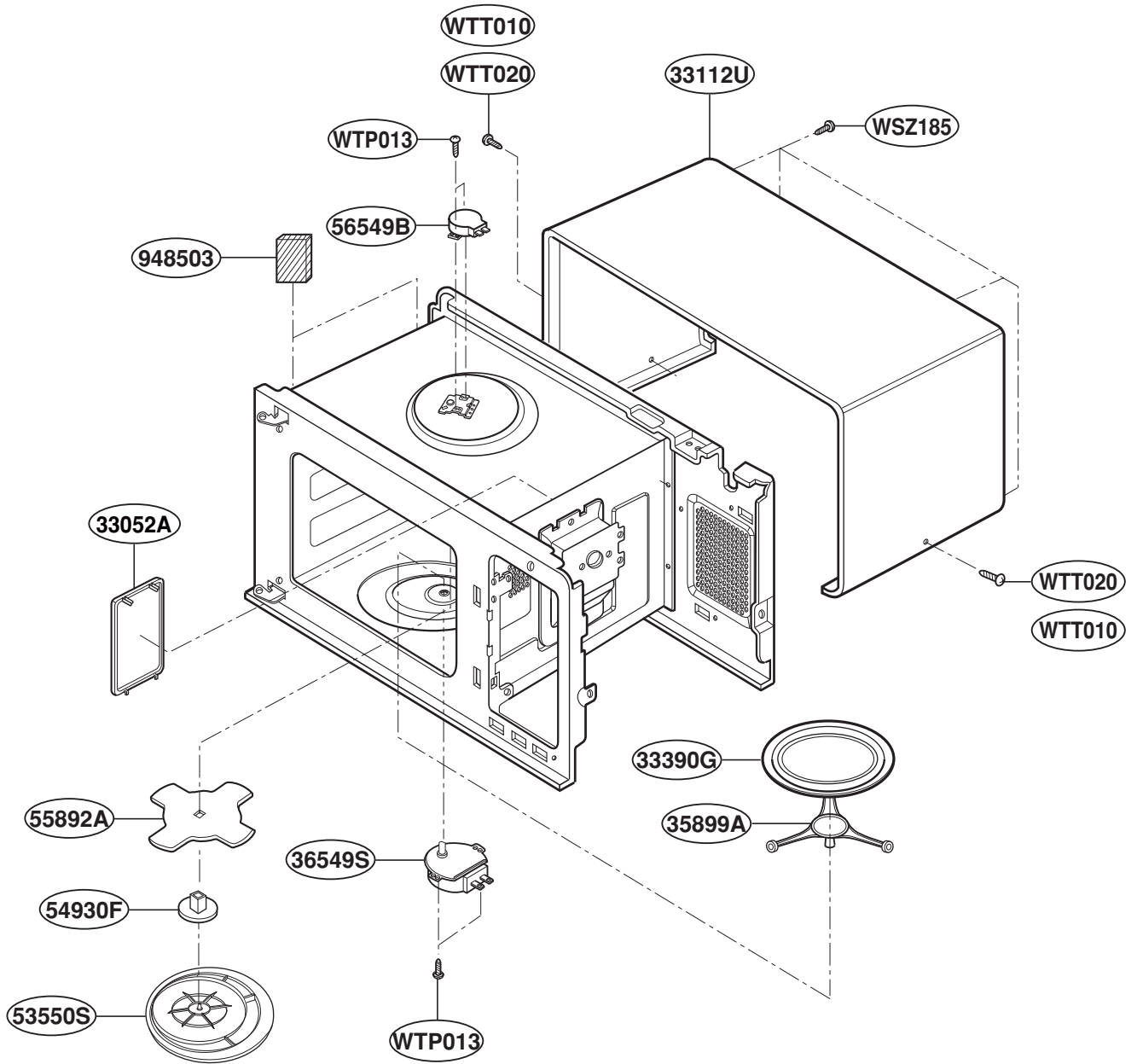

LATCH BOARD PARTS

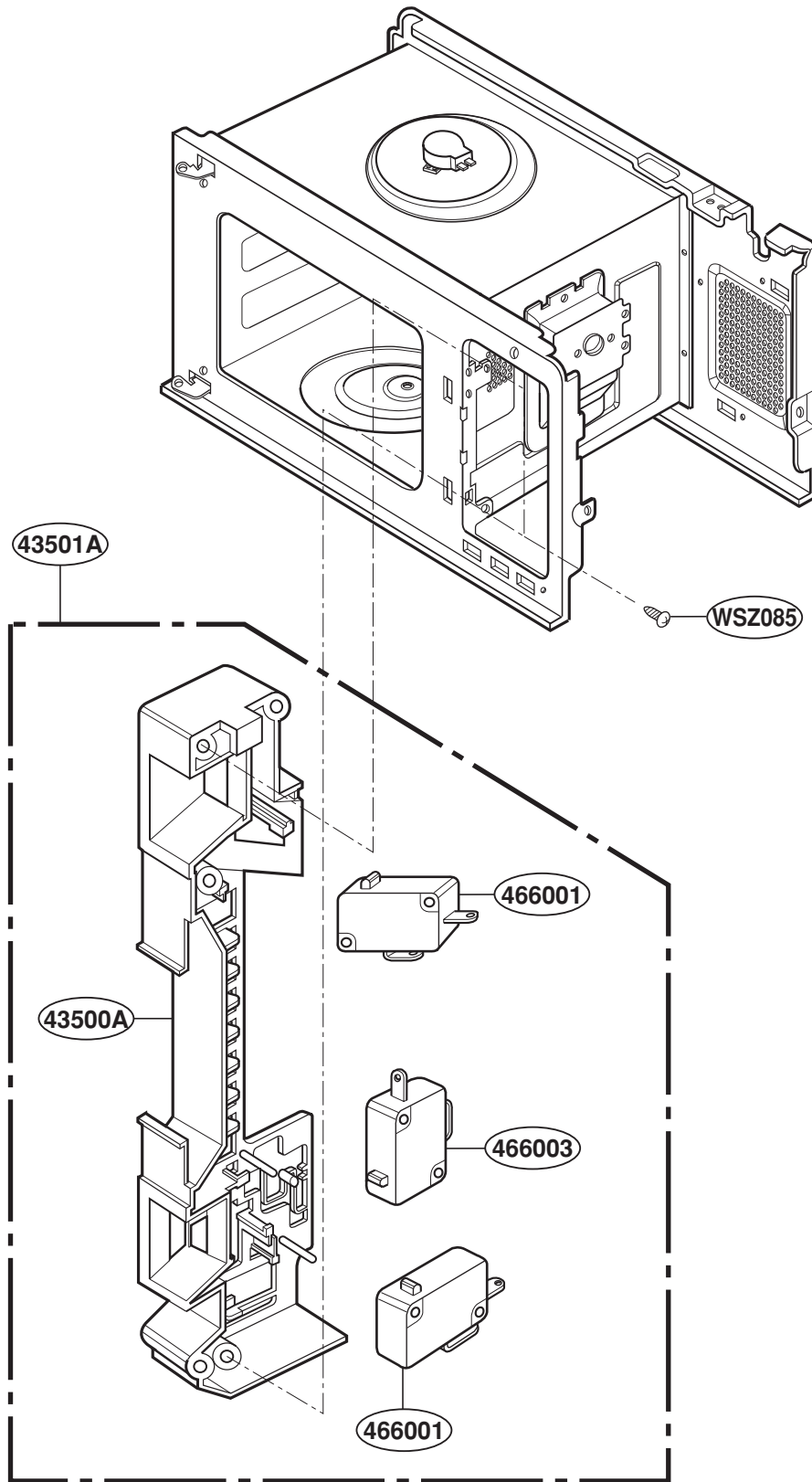

INTERIOR PARTS

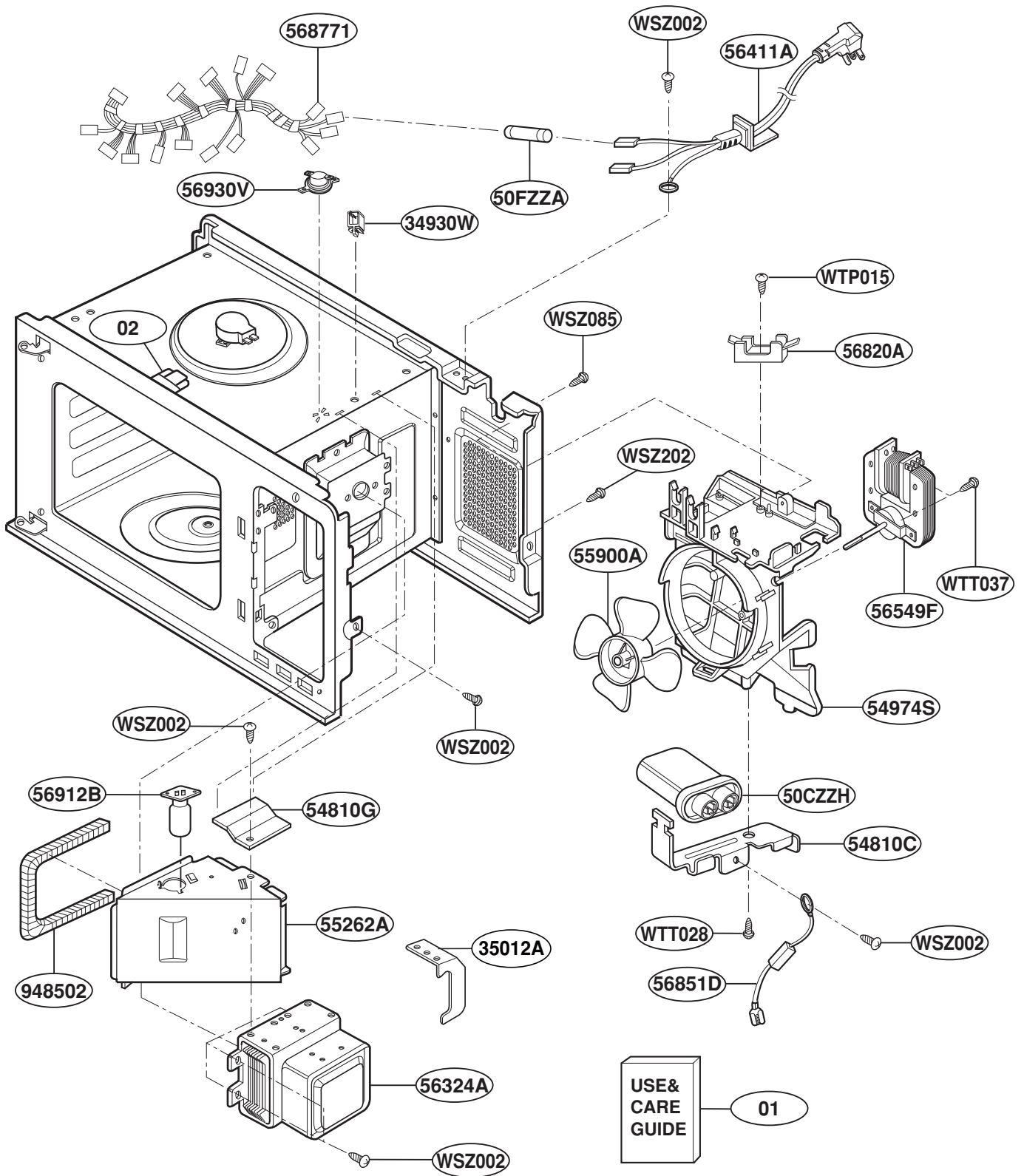

BASE PLATE PARTS

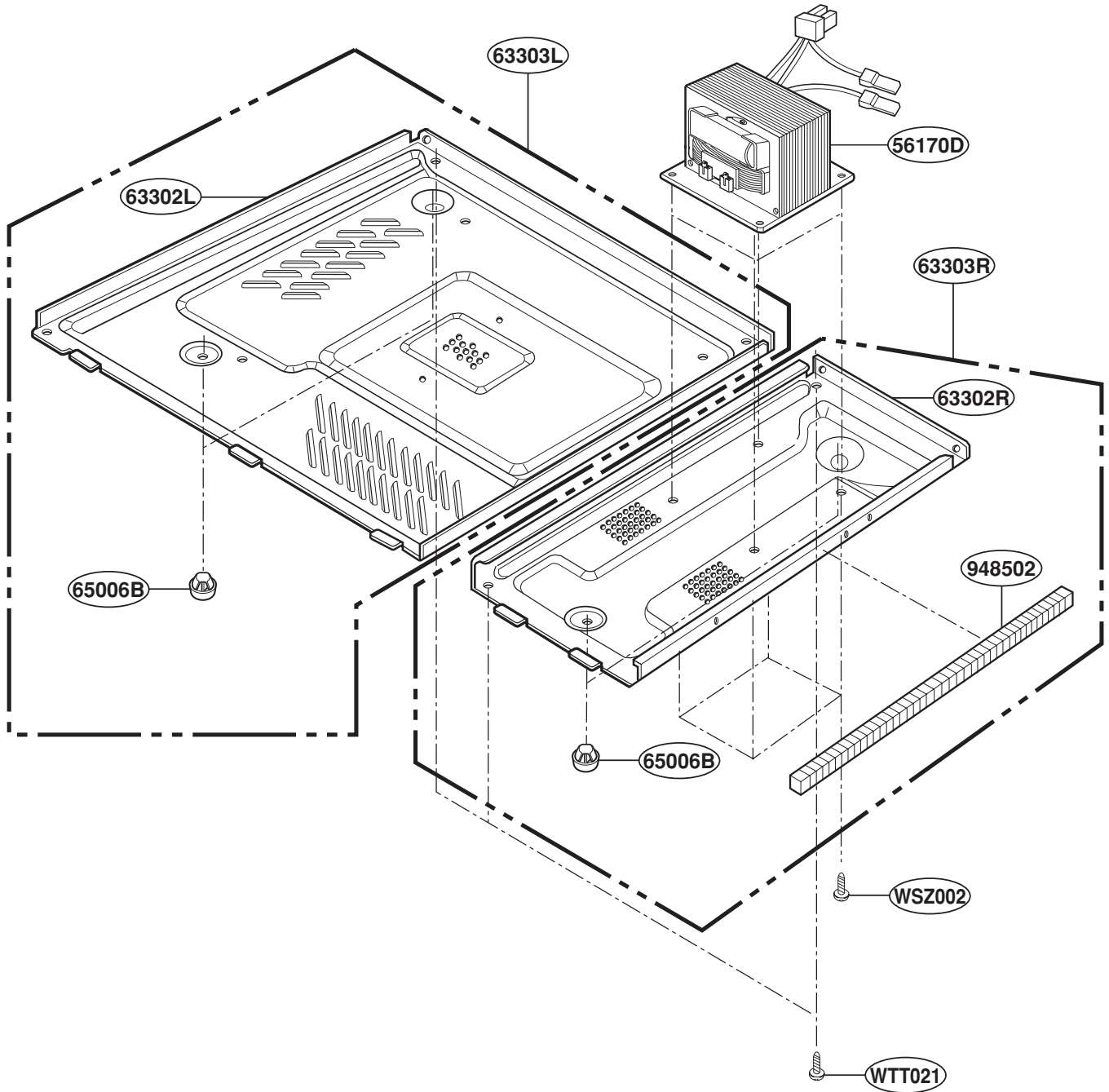

SENSOR PARTS

