

This Owner's Manual is provided and hosted by [Appliance Factory Parts](#).



# GE JES1851WB01 Owner's Manual

[Shop genuine replacement parts for GE JES1851WB01](#)

## DOOR PARTS

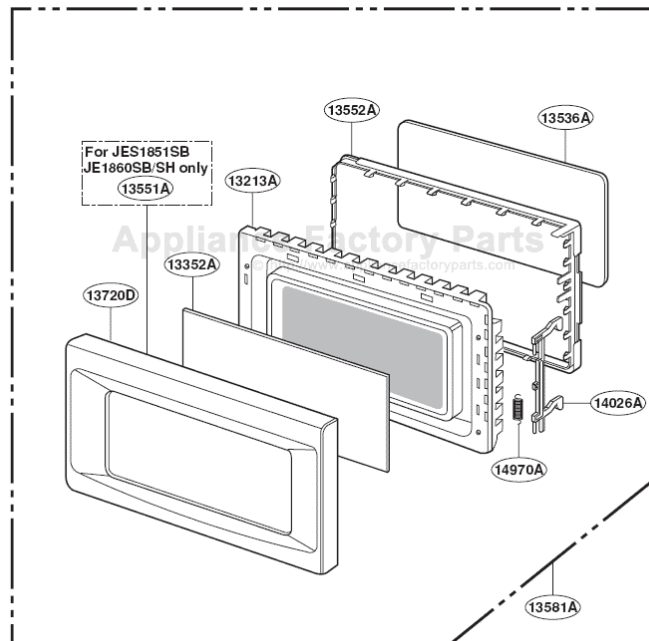

[Find Your GE Microwave Parts - Select From 3055 Models](#)

----- Manual continues below -----

# EXPLODED VIEW

## INTRODUCTION

JES1656

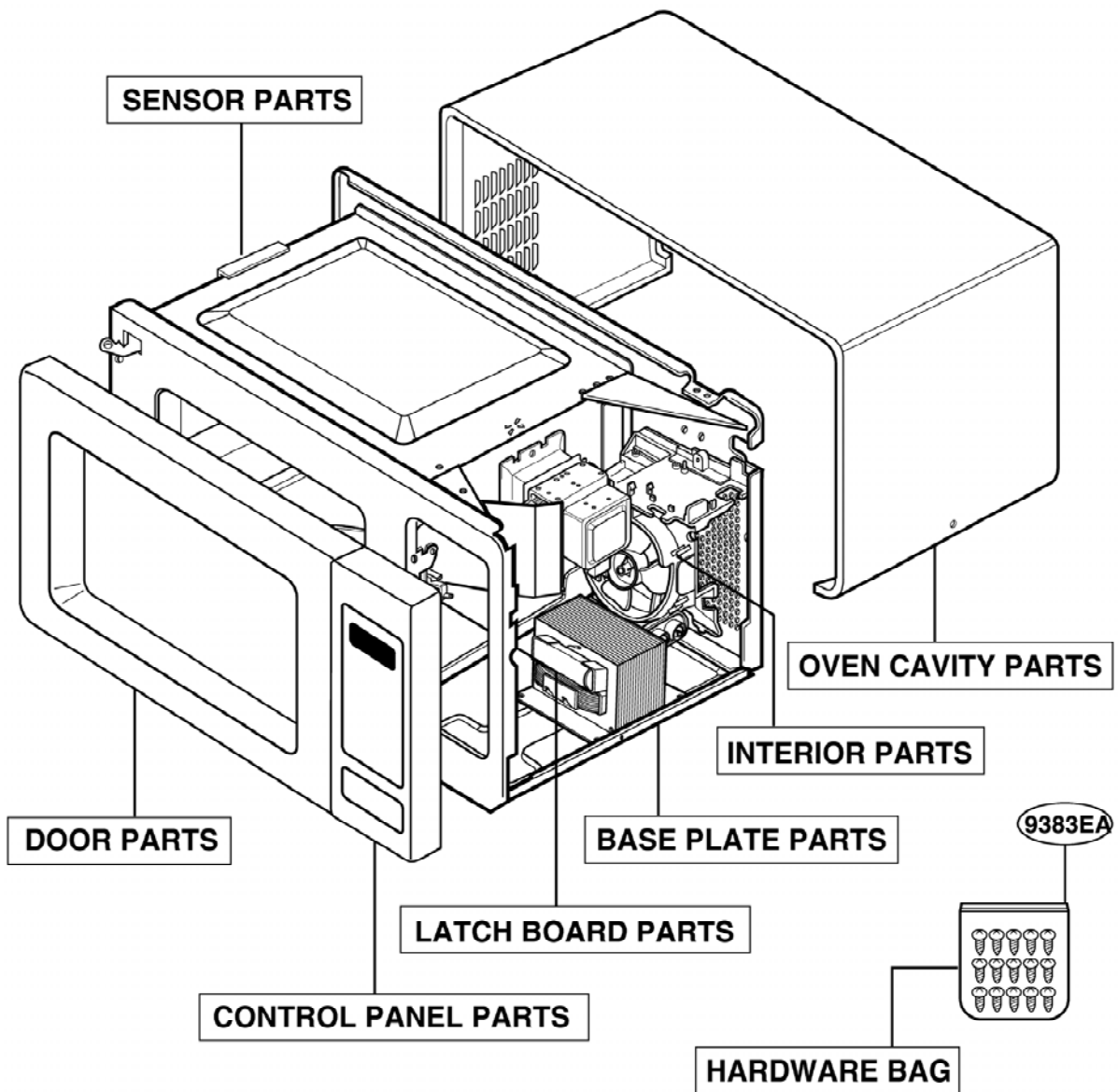

# DOOR PARTS

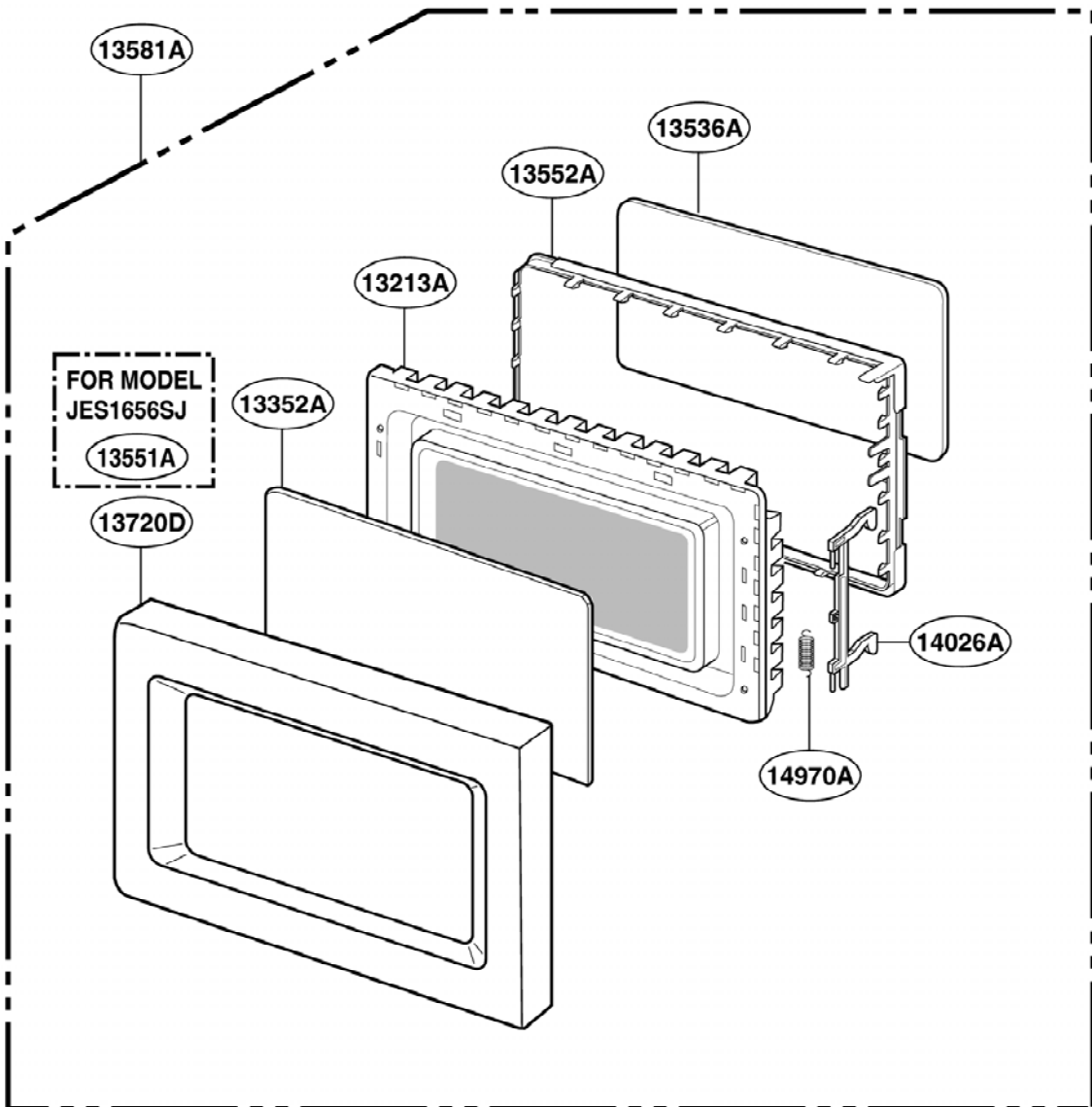

# CONTROL PANEL PARTS

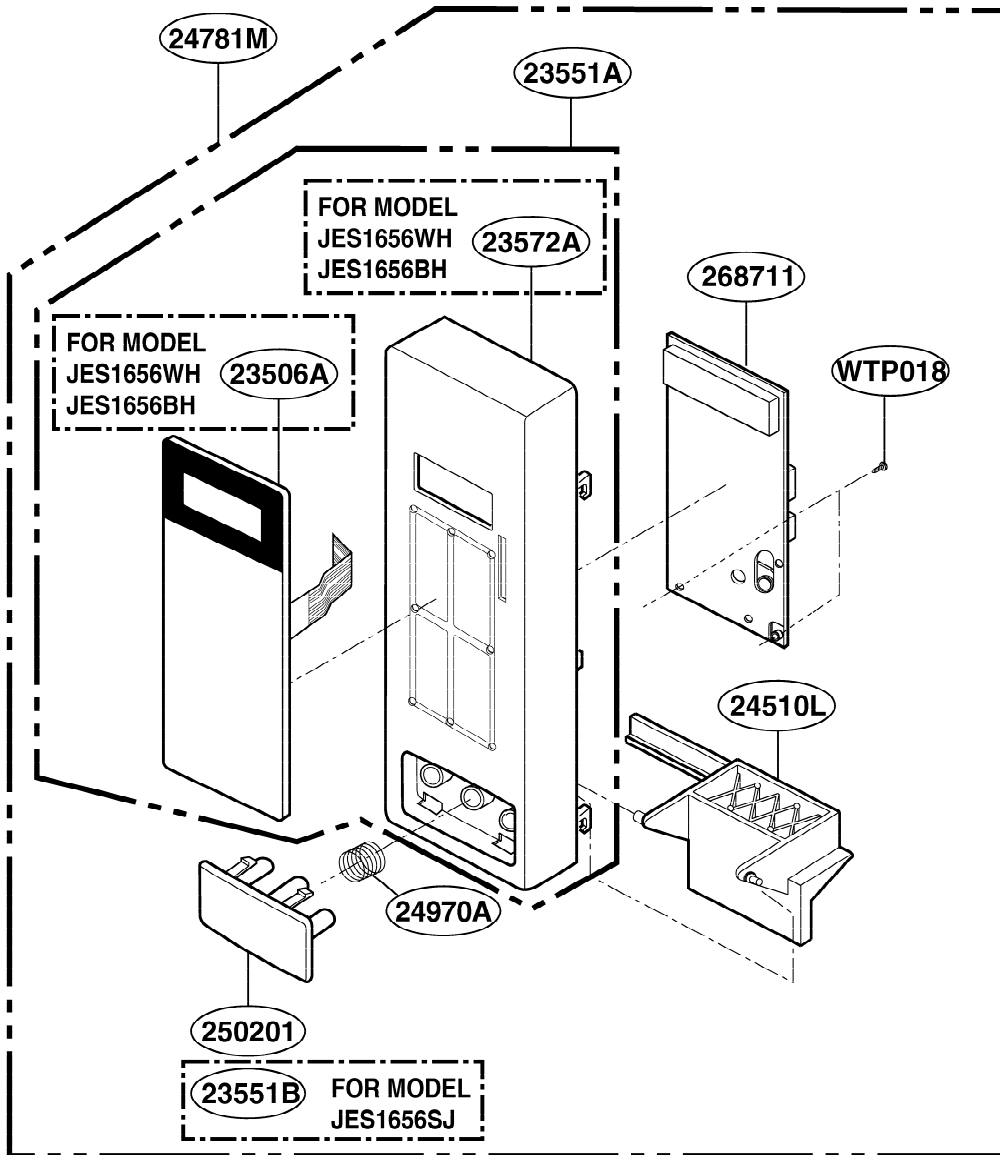

# OVEN CAVITY PARTS

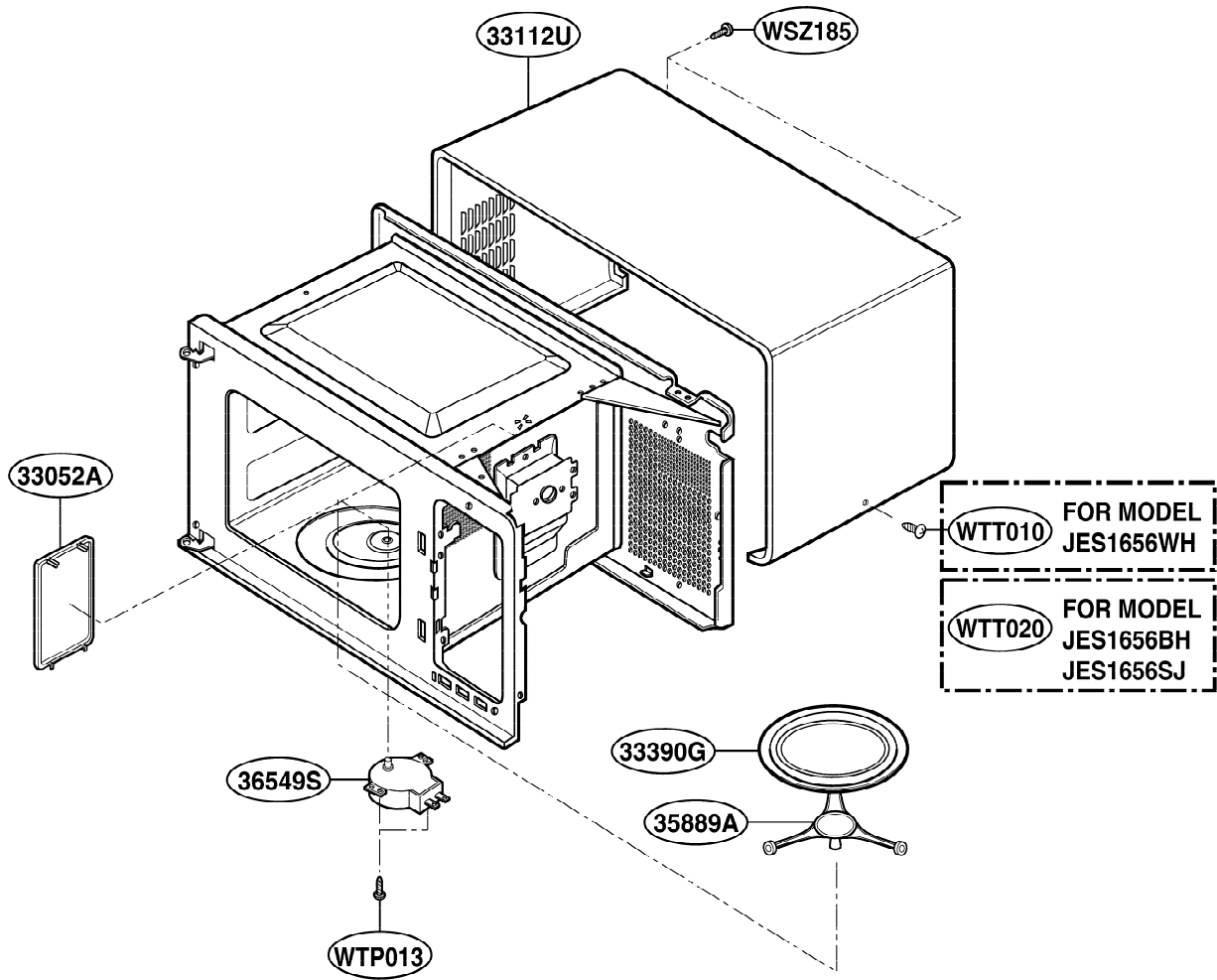

# LATCH BOARD PARTS

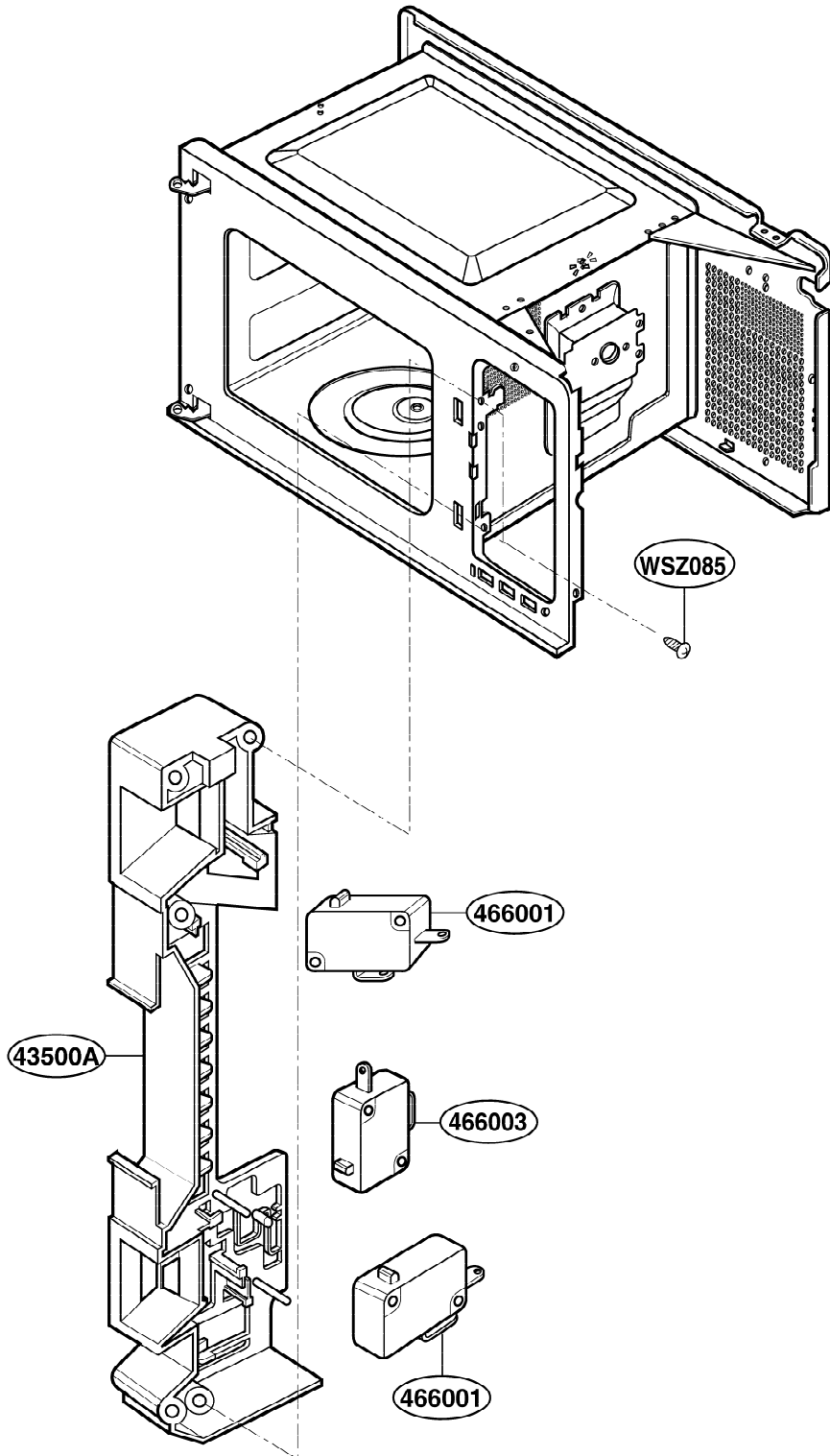

# INTERIOR PARTS (I)

Model: JES1656WH 01  
JES1656BH 01  
JES1656SJ 01

Check the rating label of **Model** and order SVC parts according to the **Model No.**

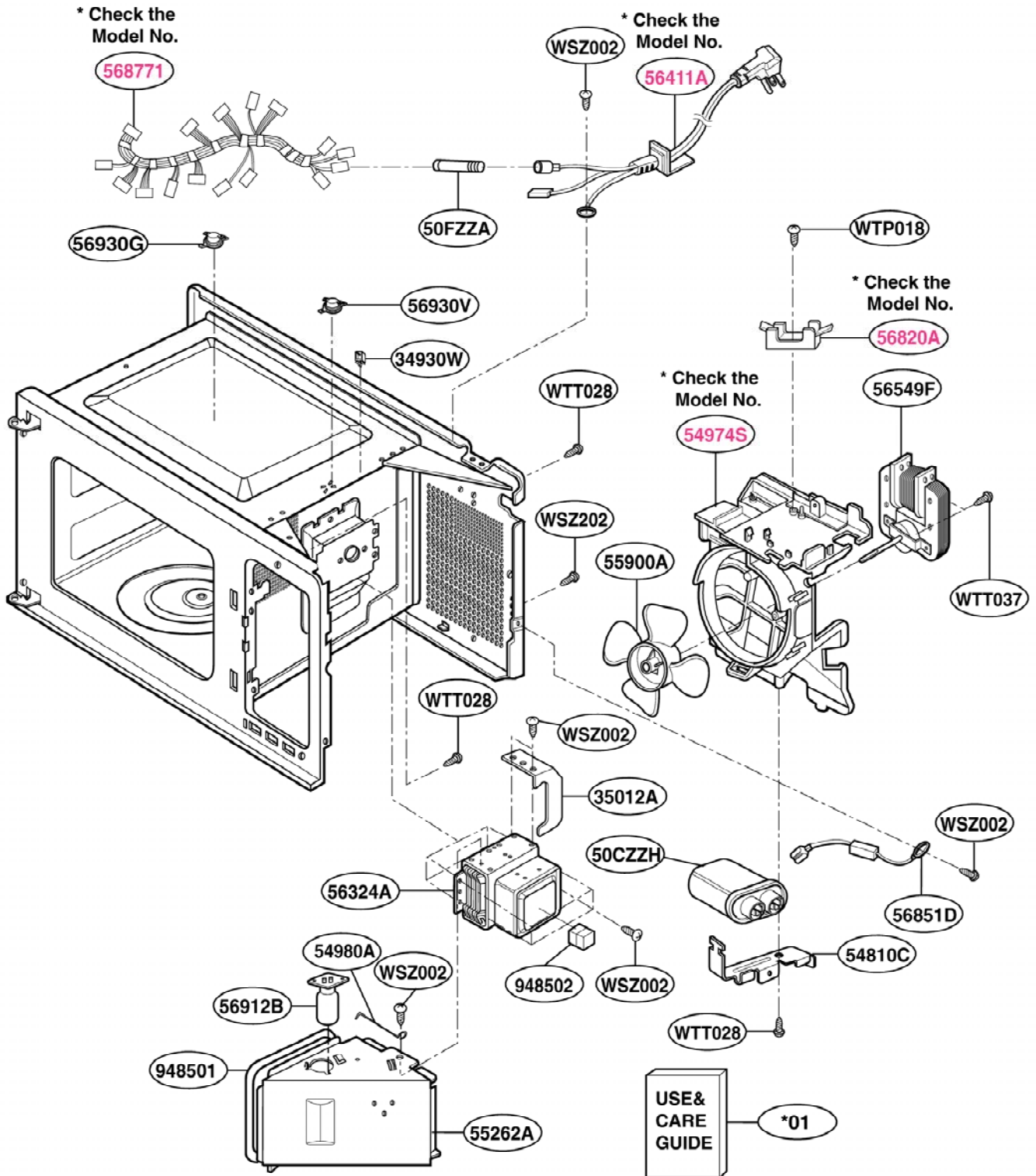

# INTERIOR PARTS (II)

Model: JES1656WH 02  
JES1656BH 02  
JES1656SJ 02

Check the rating label of **Model** and order SVC parts according to the **Model No.**

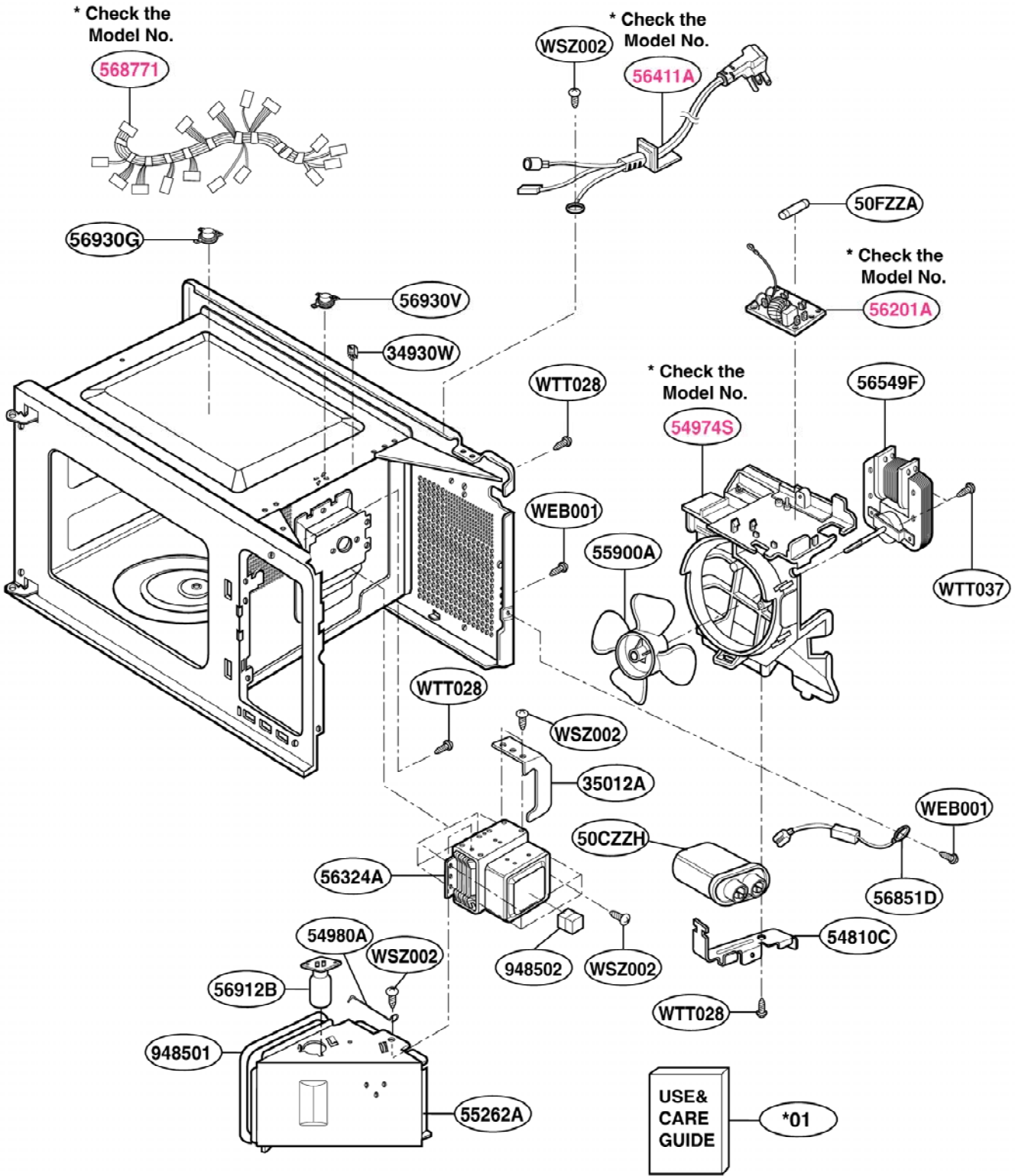

# BASE PLATE PARTS

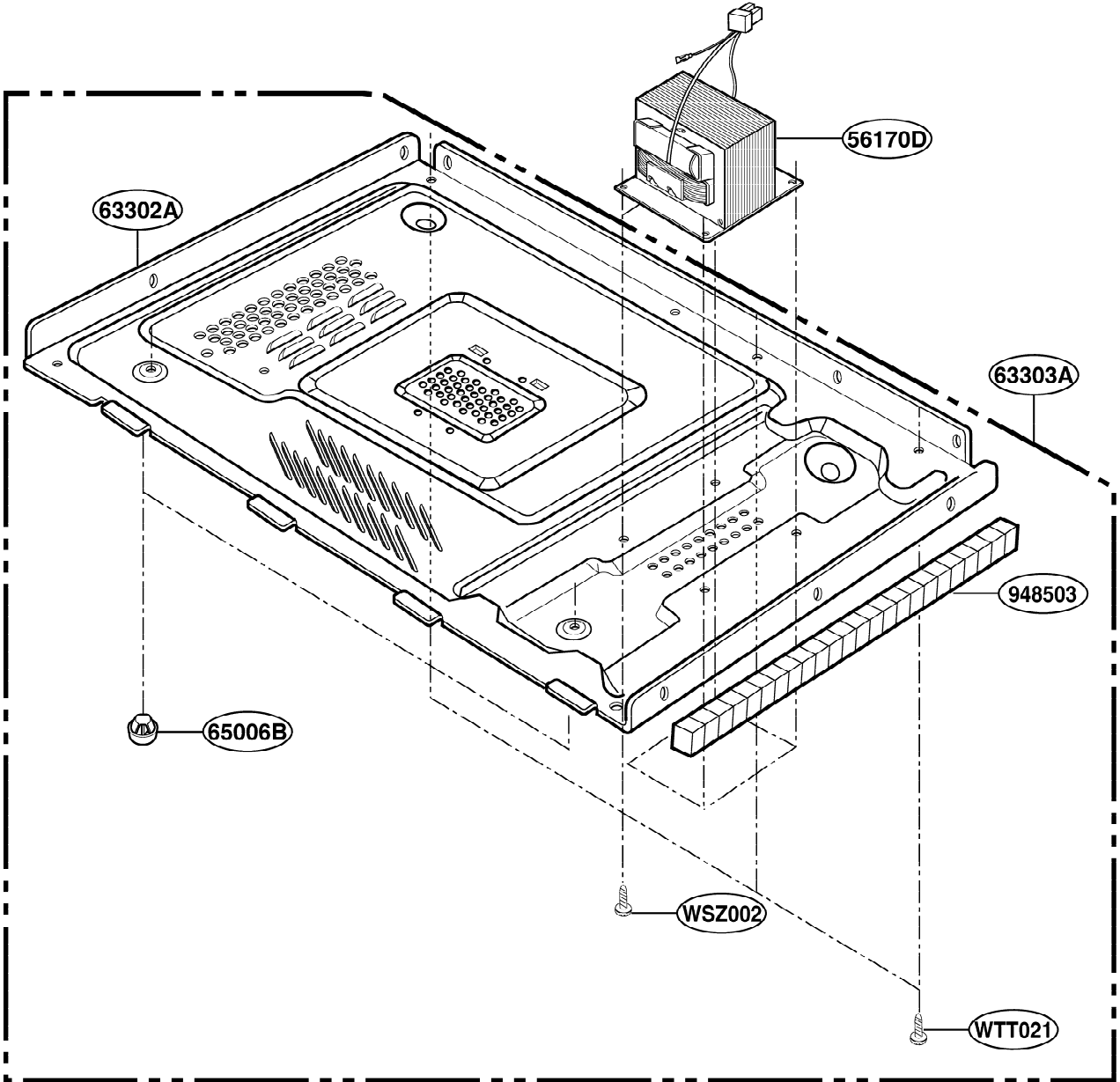

# SENSOR PARTS

