

Installation Instructions

Above the Cooktop Oven

Model JVM2052

Questions? Call 800.GE.CARES (800.432.2737) or Visit our Website at: ge.com

BEFORE YOU BEGIN

Read these instructions completely and carefully.

- **IMPORTANT** – Save these instructions for local inspector's use.
- **IMPORTANT** – Observe all governing codes and ordinances.
- **Note to Installer** – Be sure to leave these instructions with the Consumer.
- **Note to Consumer** – Keep these instructions for future reference.
- **Skill level** – Installation of this appliance requires basic mechanical and electrical skills.
- **Proper installation** is the responsibility of the installer.
- **Product failure** due to improper installation is not covered under the Warranty.

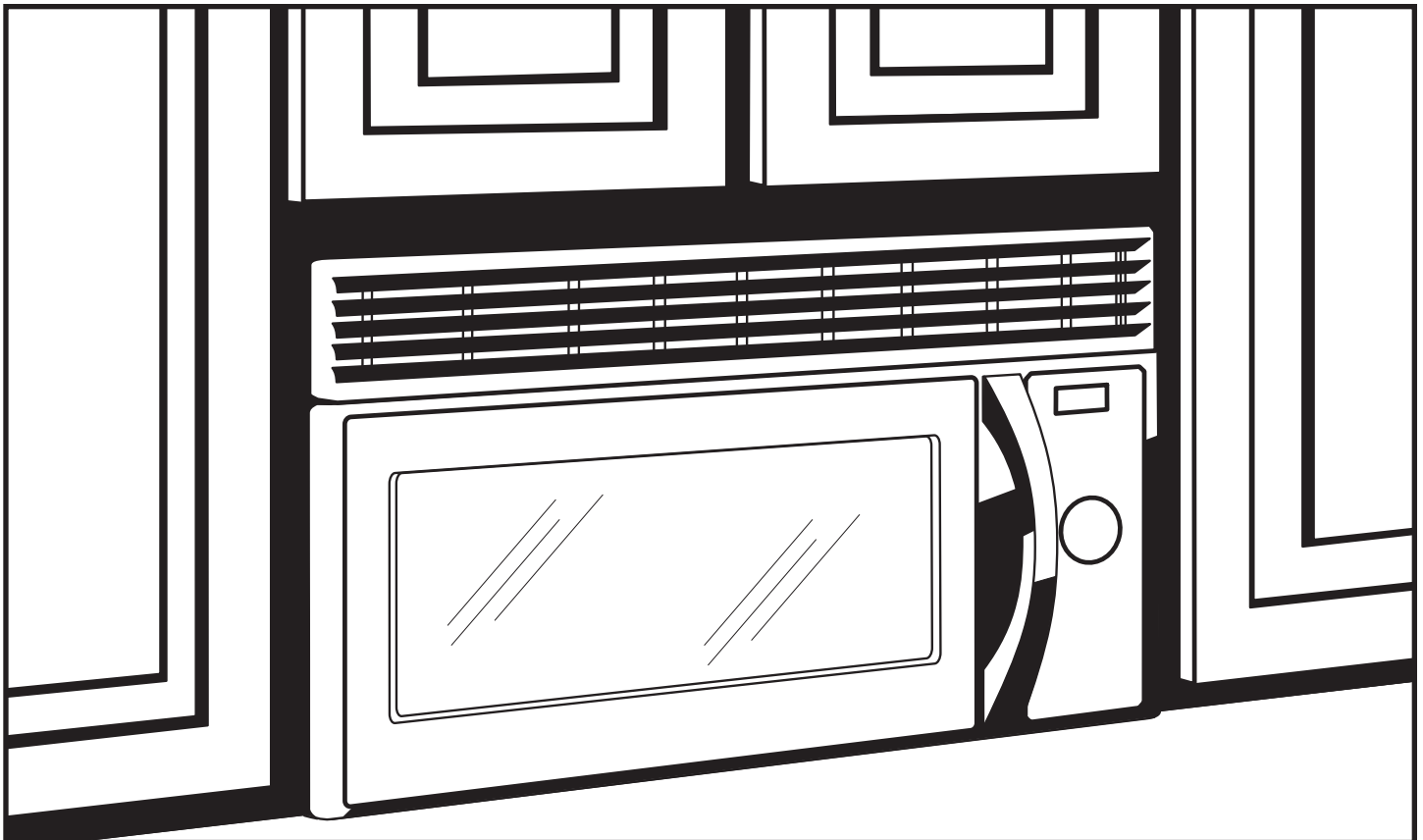

MFL57007101

49-40587

09-08 JR

**READ CAREFULLY.
KEEP THESE INSTRUCTIONS.**

Installation Instructions

CONTENTS

General information

Important Safety Instructions	3
Electrical Requirements	3
Hood Exhaust	4-5
Damage—Shipment/Installation	6
Parts Included	6
Tools You Will Need	7
Mounting Space	7

Step-by-step installation guide

Prepare the Electrical Connections	8
Prepare the Venting System	9
Prepare the Venting	10-11
Before You Start	10
Remove the Mounting Plate	10
Installation Types	10-11
Room-Vented (recirculating) Installation	10
Wall-Vented Installation	10-11
Roof-Vented Installation.....	11
Prepare the Wall & Upper Cabinet	12-13
Measure and Tack/Tape up the Templates	12
Drill the Holes in the Wall and Upper Cabinet.....	12-13
Install the Mounting Plate	13-14
Wall Stud	13-14
Wall-Vented	14
Attach the Oven to the Wall	15

Installation Instructions

IMPORTANT SAFETY INSTRUCTIONS

This product requires a three-prong grounded outlet. The installer must perform a ground continuity check on the power outlet box before beginning the installation to insure that the outlet box is properly grounded. If not properly grounded, or if the outlet box does not meet electrical requirements noted (under ELECTRICAL REQUIREMENTS), a qualified electrician should be employed to correct any deficiencies.

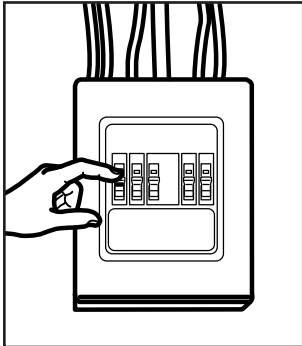

⚠ CAUTION: For personal safety, remove house fuse or open circuit breaker before beginning installation to avoid severe or fatal shock injury.

⚠ CAUTION: For personal safety, the mounting surface must be capable of supporting the cabinet load, in addition to the added weight of this 63–85 pound product, plus additional oven loads of up to 50 pounds or a total weight of 113–135 pounds.

⚠ CAUTION: For personal safety, this product cannot be installed in cabinet arrangements such as an island or a peninsula. It must be mounted to BOTH a top cabinet AND a wall.

NOTE: For easier installation and personal safety, it is recommended that two people install this product.

IMPORTANT—PLEASE READ CAREFULLY.
FOR PERSONAL SAFETY, THIS APPLIANCE MUST BE PROPERLY GROUNDED TO AVOID SEVERE OR FATAL SHOCK.

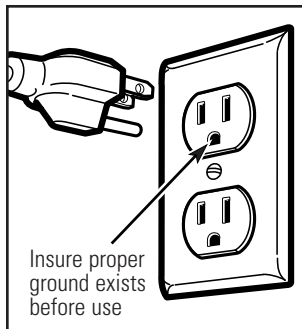

The power cord of this appliance is equipped with a three-prong (grounding) plug which mates with a standard three-prong (grounding) wall receptacle to minimize the possibility of electric shock hazard from this appliance.

Insure proper ground exists before use

You should have the wall receptacle and circuit checked by a qualified electrician to make sure the receptacle is properly grounded.

Where a standard two-prong wall receptacle is encountered, it is very important to have it replaced with a properly grounded three-prong wall receptacle, installed by a qualified electrician.

DO NOT, UNDER ANY CIRCUMSTANCES, CUT, DEFORM OR REMOVE ANY OF THE PRONGS FROM THE POWER CORD. DO NOT USE WITH AN EXTENSION CORD.

ELECTRICAL REQUIREMENTS

Product rating is 120 volts ACE, 60 Hertz, 14.5 amps and 1.70 kilowatts. This product must be connected to a supply circuit of the proper voltage and frequency. Wire size must conform to the requirements of the National Electrical Code or the prevailing local code for this kilowatt rating. The power supply cord and plug should be brought to a separate 15 to 20 ampere branch circuit single grounded outlet. The outlet box should be located in the cabinet above the oven. The outlet box and supply circuit should be installed by a qualified electrician and conform to the National Electrical Code or the prevailing local code.

Installation Instructions



HOOD EXHAUST

NOTE: Read these next two pages only if you plan to vent your exhaust to the outside. If you plan to recirculate the air back into the room, proceed to page 6.

OUTSIDE TOP EXHAUST (EXAMPLE ONLY)

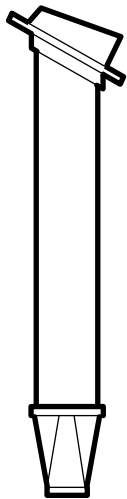
The following chart describes an example of one possible ductwork installation.



DUCT PIECES		EQUIVALENT LENGTH	x	NUMBER USED	=	EQUIVALENT LENGTH	
	Roof Cap	24 Ft.	x	(1)	=	24 Ft.	
	12 Ft. Straight Duct (6" Round)	12 Ft.	x	(1)	=	12 Ft.	
	Rectangular-to-Round Transition Adapter*	5 Ft.	x	(1)	=	5 Ft.	
Total Length						=	41 Ft.



Equivalent lengths of duct pieces are based on actual tests and reflect requirements for good venting performance with any vent hood.

***IMPORTANT:** If a rectangular-to-round transition adapter is used, the bottom corners of the damper will have to be cut to fit, using the tin snips, in order to allow free movement of the damper.

OUTSIDE BACK EXHAUST (EXAMPLE ONLY)

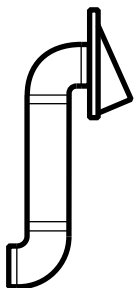
The following chart describes an example of one possible ductwork installation.

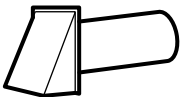

DUCT PIECES		EQUIVALENT LENGTH*	x	NUMBER USED	=	EQUIVALENT LENGTH	
	Wall Cap	40 Ft.	x	(1)	=	40 Ft.	
	3 Ft. Straight Duct (3/4" x 10" Rectangular)	3 Ft.	x	(1)	=	3 Ft.	
	90° Elbow	10 Ft.	x	(2)	=	20 Ft.	
Total Length						=	63 Ft.

Equivalent lengths of duct pieces are based on actual tests and reflect requirements for good venting performance with any vent hood.

NOTE: For back exhaust, care should be taken to align exhaust with space between studs, or wall should be prepared at the time it is constructed by leaving enough space between the wall studs to accommodate exhaust.

Installation Instructions

NOTE: If you need to install ducts, note that the total duct length of 3¼" x 10" rectangular or 6" diameter round duct **should not exceed 120 equivalent feet.**

Outside ventilation requires a HOOD EXHAUST DUCT. Read the following carefully.

NOTE: It is important that venting be installed using the most direct route and with as few elbows as possible. This ensures clear venting of exhaust and helps prevent blockages. **Also, make sure dampers swing freely and nothing is blocking the ducts.**

Exhaust connection:







The hood exhaust has been designed to mate with a standard 3¼" x 10" rectangular duct.

If a round duct is required, a rectangular-to-round transition Adapter must be used. **Do not use less than a 6" diameter duct.**

Maximum duct length:

For satisfactory air movement, the total duct length of 3¼" x 10" rectangular or 6" diameter round duct **should not exceed 120 equivalent feet.**

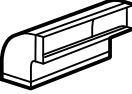
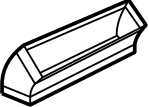
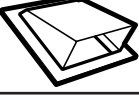
Elbows, transitions, wall and roof caps, etc., present additional resistance to airflow and are equivalent to a section of straight duct which is longer than their actual physical size. When calculating the total duct length, add the equivalent lengths of all transitions and adapters plus the length of all straight duct sections. The chart below shows you how to calculate total equivalent ductwork length using the approximate feet of equivalent length of some typical ducts.

DUCT PIECES	EQUIVALENT LENGTH	x	NUMBER USED	=	EQUIVALENT LENGTH
 Rectangular-to-Round Transition Adapter*	5 Ft.	x	()	=	Ft.
 Wall Cap	40 Ft.	x	()	=	Ft.
 90° Elbow	10 Ft.	x	()	=	Ft.
 45° Elbow	5 Ft.	x	()	=	Ft.
 90° Elbow	25 Ft.	x	()	=	Ft.
 45° Elbow	5 Ft.	x	()	=	Ft.
 Roof Cap	24 Ft.	x	()	=	Ft.
 Straight Duct 6" Round or 3¼" x 10" Rectangular	1 Ft.	x	()	=	Ft.
Total Ductwork =					Ft.



*** IMPORTANT:** If a rectangular-to-round transition Adapter is used, the bottom corners of the damper will have to be cut to fit, using the tin snips, in order to allow free movement of the damper.

Equivalent lengths of duct pieces are based on actual tests and reflect requirements for good venting performance with any vent hood.





Installation Instructions

DAMAGE – SHIPMENT/ INSTALLATION

- If the unit is damaged in shipment, return the unit to the store in which it was bought for repair or replacement.
- If the unit is damaged by the customer, repair or replacement is the responsibility of the customer.
- If the unit is damaged by the installer (if other than the customer), repair or replacement must be made by arrangement between customer and installer.

PARTS INCLUDED

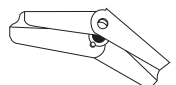
HARDWARE PACKET

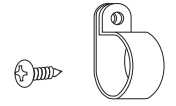
PART	QUANTITY
 Lag Screws (1/4" x 2") (for wall stud holes)	4
 Toggle Bolts (1/4" x 3") (for drywall holes)	4
 Spring Toggle Heads (for toggle bolts)	4
 Bolts (for securing to the upper cabinet)	2
 Tapping Screws (1/8" x 1/2") (for attaching the damper duct connector)	1 black 2 bronze
 Power Cord Clamp and Dark-Colored Mounting Screw (to hold the power cord)	1





You will find the installation hardware contained in a packet with the unit. Check to make sure you have all these parts.

NOTE: Some extra parts are included.

NOTE: You need to install at least two lag screws into a 2" x 4" stud and four anchor bolts into the wall. Also, the mounting area must meet the 150 lbs. weight requirement.

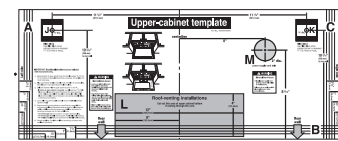
PARTS INCLUDED

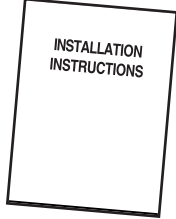
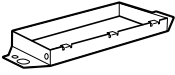
ADDITIONAL PARTS

PART	QUANTITY
 Upper Cabinet Template	1
 Rear Wall Template (3 pieces mounting plate only)	1
 Installation Instructions	1
 Exhaust Adapter	1
 Damper	1
 Power Cord Clamp Bushing (for the cord hole in a metal upper cabinet)	1

Installation Instructions

TOOLS YOU WILL NEED

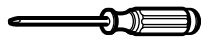

Phillips screwdriver

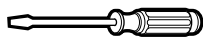

Flat blade screwdriver



Ruler or tape measure and straight edge

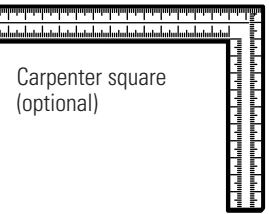
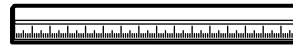

Carpenter square (optional)

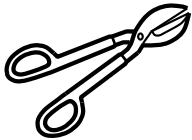

Tin snips (for cutting damper, if required)



Pencil



Scissors (to cut template, if necessary)

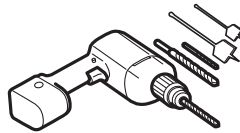

Electric drill with $\frac{3}{8}$ " and $\frac{3}{4}$ " wood drill bits and $\frac{3}{16}$ " and $\frac{1}{2}$ " drill bits



Plumb line



Gloves

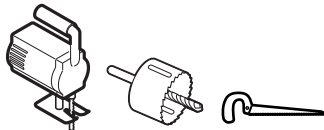

Saw (saber, hole or keyhole)



Stud finder

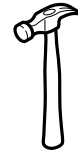

or Hammer (optional)

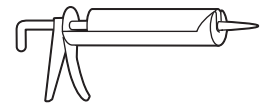

Caulking gun



Safety goggles



Clear tape (for taping the templates to the wall)

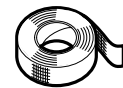

Duct and masking tape

MOUNTING SPACE

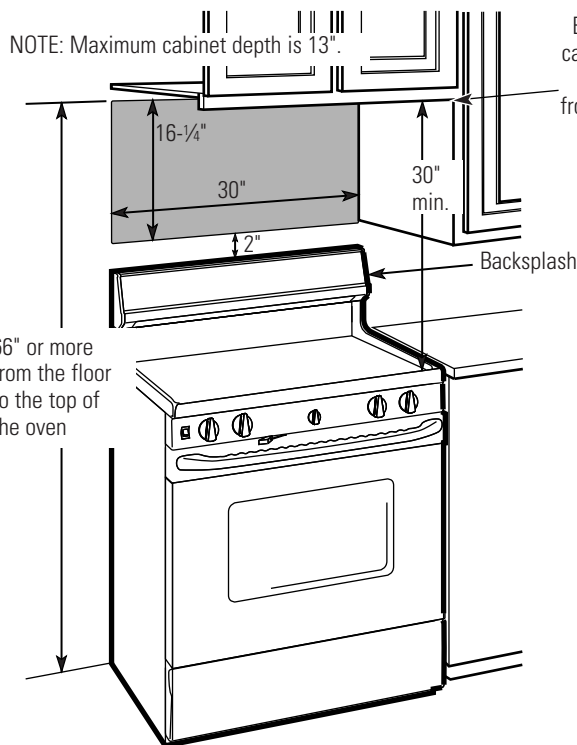

Bottom edge of cabinet needs to be 30" or more from the cooking surface

NOTES:

- The space between the cabinets must be 30" wide and free of obstructions.
- If the space between the cabinets is greater than 30", a Filler Panel Kit may be used to fill in the gap between the oven and the cabinets. Your Owner's Manual contains the kit number for your model.
- This oven is for installation over ranges up to 36" wide.
- If you are going to vent your oven to the outside, see Hood Exhaust Section for exhaust duct preparation.
- **When installing the oven beneath smooth, flat cabinets, be careful to follow the instructions on the upper cabinet template for power cord clearance.**
- Maximum cabinet depth above and beside the unit is 13".
- **For models with top venting holes:** Do not allow cabinetry or other objects to block the airflow of the vent.

Installation Instructions

1 PREPARE THE ELECTRICAL CONNECTIONS

⚠ WARNING: Avoid electrical shock!
This appliance must be grounded!

1 Locate the grounded electric outlet for this oven in the cabinet above the oven, as shown at right.

NOTE: The outlet should be on a circuit dedicated to the microwave oven (120V, 60 Hz., AC only) with a 15 or 20A fused electrical supply.

IMPORTANT: If you do not have the proper wall outlet, you **MUST** have one installed by a qualified electrician.

⚠ WARNING: Improper grounding could result in electric shock or other personal injury.

- DO NOT, UNDER ANY CIRCUMSTANCES, REMOVE THE POWER SUPPLY CORD GROUNDING PRONG!
- This appliance **MUST** be grounded!

2 You will cut the power-supply-cord hole (shown below) later when you prepare the wall and upper cabinet in Step 4.

NOTE: Do not use an extension cord. Keep the power cord dry and do not pinch or crush it.

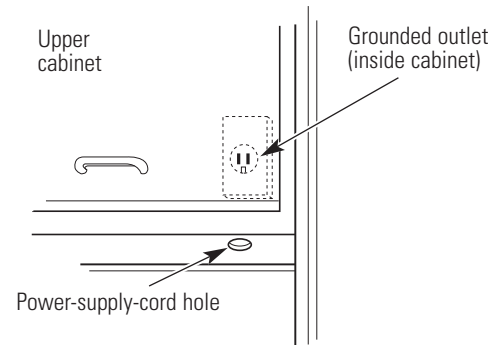

Installation Instructions

2 PREPARE THE VENTING SYSTEM

NOTE: The ductwork you need for outside ventilation is not included with your oven. The standard ductwork fittings and length are shown on pages 4 and 5.

⚠ WARNING: This oven must be properly vented.

You may vent your oven in one of three ways. Do NOT vent into a wall cavity, an attic or an unused area.

Roof Venting—If your oven is located on an outside wall near the roof, as shown below (3 1/4" x 10" duct or 6" round duct).

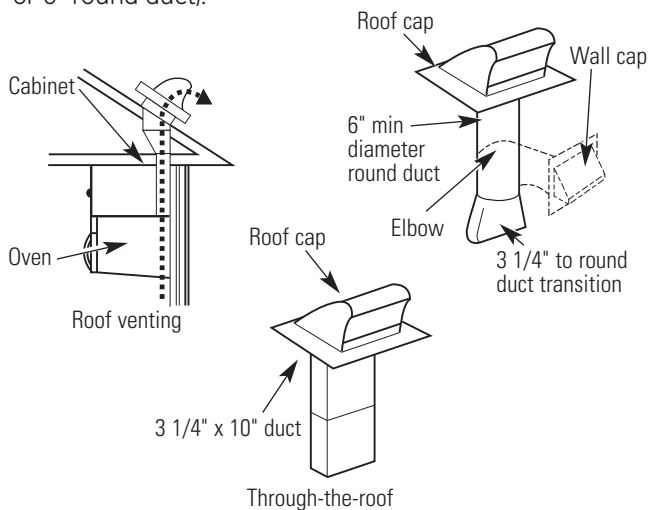

Wall Venting—If your oven is located on an outside wall of your house, as shown below (3 1/4" x 10" duct or 6" round duct.)

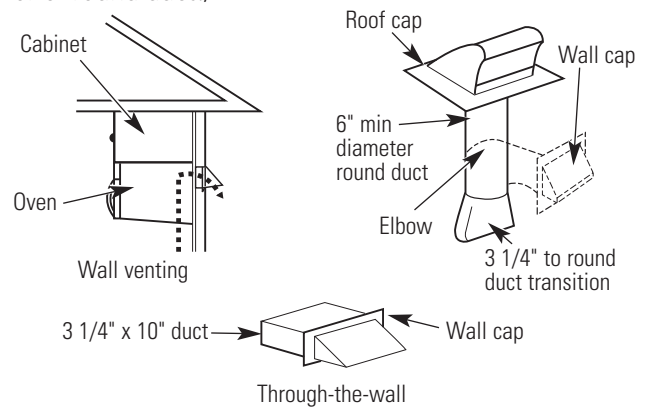

Room Venting—If your oven is located on an inside wall of your house, as shown below.

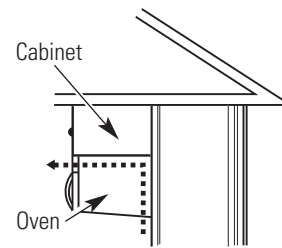

NOTE: If you choose the rear exhaust method (roof- or wall-venting), be sure there is enough clearance within the wall for the exhaust duct.

REMEMBER AS YOU INSTALL THE VENTING: Keep the length of the ductwork and the number of elbows to a minimum to ventilate your oven efficiently. See examples on page 5. Keep the size of the ductwork the same. Do not install two elbows together. Use duct tape to seal all joints in the duct system. Use caulking to seal the exterior wall or roof opening around the cap.

Installation Instructions

3 PREPARE THE VENTING

⚠ WARNING:

- To avoid the risk of property damage, unplug the microwave oven or disconnect power at the source by removing the fuse or throwing the circuit breaker.
- To avoid the risk of personal injury, wear protective gloves when handling the mounting plate.
- DO NOT PULL OR STRETCH THE BLOWER WIRING! Pulling and stretching the blower wiring could result in electrical shock.

NOTE: Your microwave oven is shipped with the blower assembled for room venting. If you want wall-vented or roof-vented installation, you must change the blower, as detailed below.

A BEFORE YOU START

- 1 Remove any shipping materials and parts from inside the microwave oven.
- 2 Cover the counter top or cooktop with a thick, protective covering to protect it from damage and dirt.

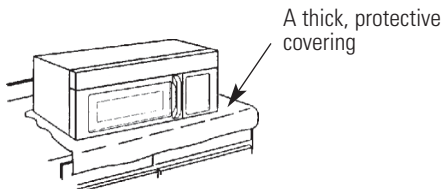

NOTE: If you have a free-standing range, disconnect it, move it onto a piece of cardboard or hardboard and pull it away from the wall. This allows you to get closer to the upper cabinet and back wall for easier measuring and drilling.

B REMOVE THE MOUNTING PLATE

- 1 Remove the mounting plate screw(s) (1 or 2 screws) from the mounting plate as shown and discard.

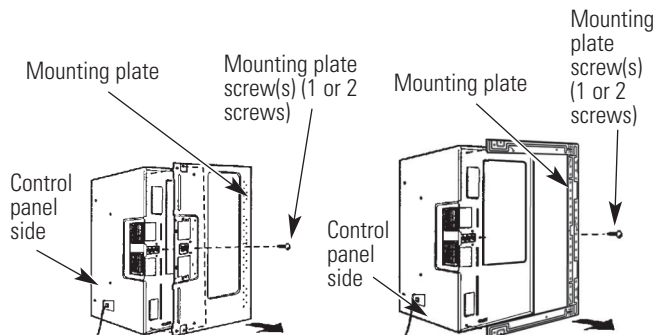

- 2 This plate will be used as the rear mounting plate. (It will be used to locate and mark the mounting holes on the rear wall.)
- 3 Locate the exhaust adapter, grease filters and hardware packet.
- 4 At this point, remove any adhesive tape (if there is any), on the exhaust adapter, the grease filters and the power supply cord.

C INSTALLATION TYPES

Room-Vented (recirculating) Installation:

This oven is shipped assembled for room venting.

Wall-Vented Installation:

- 1 Remove one blower unit mounting screw and one or two blower plate screw(s). Remove the blower plate from the cabinet.

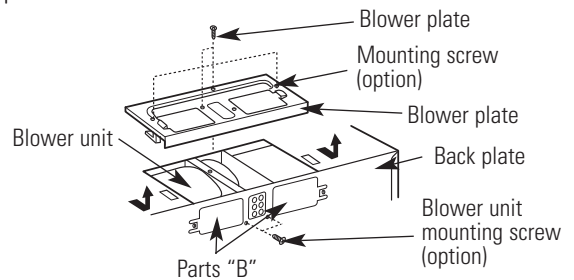

- 2 Carefully lift the blower unit out of the microwave oven.
- 3 Use side cutters or tin snips to cut and remove knockouts "B" from back plate. Discard the knockouts. Be careful not to distort the plate.

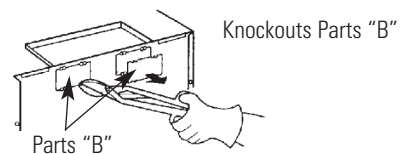

Installation Instructions

3 PREPARE THE VENTING (cont.)

C INSTALLATION TYPES (cont.)

Wall-Vented Installation (cont.):

- 4 Reassemble the blower wire.

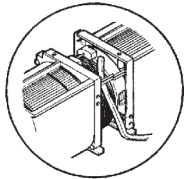

- 5 Rotate the unit so that the exhaust ports face the rear of the cabinet. When you insert the blower unit, the blower wire must be as shown.

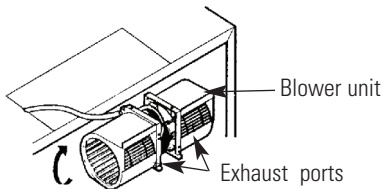

- 6 Place the blower unit back into the cabinet. Check that the exhaust ports face toward the rear of the cabinet.

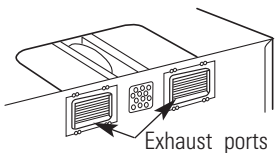

- 7 Reattach the blower plate to the cabinet so the exhaust ports and blower plate opening are aligned. Attach with one blower unit mounting screw and then one blower plate mounting screw.

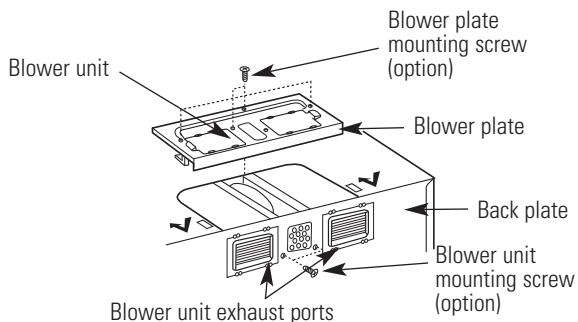

Roof-Vented Installation:

- 1 Remove one blower unit mounting screw and one or two blower plate screw(s). Remove the blower plate from the cabinet.

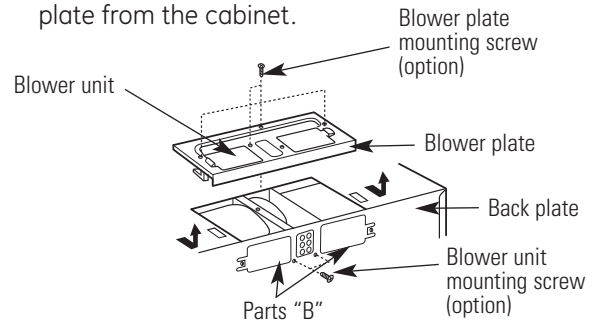

- 2 Use side cutter or tin snips to cut and remove knockouts "A" from the blower plate. Discard knockouts. Be careful not to distort the plate.

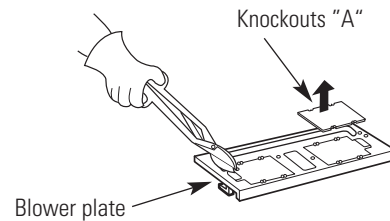

- 3 Carefully lift the blower unit out of the microwave oven.

- 4 Rotate the blower unit 90° so the exhaust ports face the top of the cabinet.

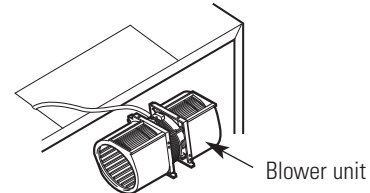

- 5 Reassemble the blower wire.

- 6 Place the blower unit back into the microwave oven.

- 7 Reattach the blower plate to the microwave oven. Attach with the one blower unit mounting screw and then the one or two blower plate mounting screw(s).

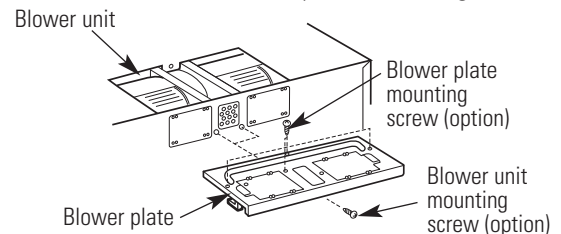

- 8 Attach the exhaust adapter to the blower plate by sliding it into the Guide.

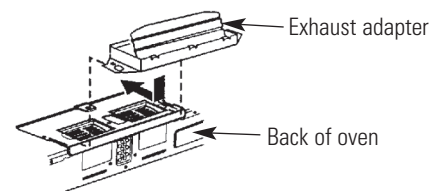

Installation Instructions

4 PREPARE THE WALL AND UPPER CABINET

⚠ WARNING: To avoid personal injury or property damage, do not attempt to install this microwave oven if you cannot find a wall stud.

Measure and Tack/Tape Up the Templates

- 1 Using a plumb line and measuring tape, find and mark the vertical center line on the back wall, as shown.

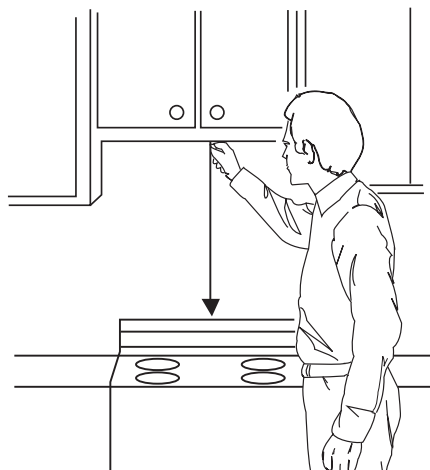

- 2 Find and mark one or two points where the studs are on the wall. Then measure and mark the stud locations. If you cannot find any wall stud, consult a local building contractor.

CAUTION: DO NOT ATTEMPT TO INSTALL THE MICROWAVE OVEN IF YOU CANNOT FIND A WALL STUD.

- 3 Line up the plumb line on the wall with the center line on the mounting plate.

NOTE: Be sure the minimum width is 30 inches and the distance from the top of the wall template to the range or counter top is at least 30 inches.

- 4 Center the mounting plate by lining up the plumb line on the wall with the center line on the mounting plate. Make sure the minimum width is 30 inches and that the top of the mounting plate is located a minimum of 30 inches above the cooking surface.

NOTE: If the cabinets are not plumb, adjust the mounting plate to the cabinets. If the front edge of the cabinet is lower than the back edge, adjust the mounting plate to be level with the cabinet front.

- 5 Measure the bottom of the upper cabinet frame. Trim the edges A, B and C on the upper cabinet template so that the template will fit on the bottom of the upper cabinet. If the upper cabinet has a recessed area, trim the template so it fits inside the recessed area. Align the center line of the upper cabinet template with the center line of the mounting plate, then securely tape or tack the upper cabinet template in place.

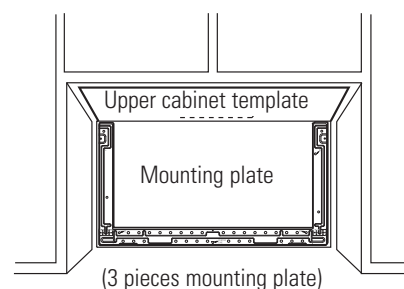
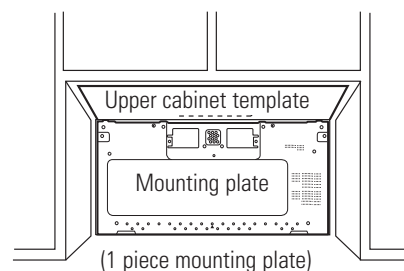

⚠ WARNING: To avoid the risk of personal injury, electrical shock or death:

- Note where electrical outlets and electrical wires are before you drill into the wall.
- Locate and disconnect power to any electrical circuits that could be affected by installing this oven.

⚠ WARNING: To avoid the risk of personal injury, electrical shock or death, cover the edge of the power supply cord hole with the power supply cord bushing.

Drill the Holes in the Wall and Upper Cabinet

- 1 Drill holes on the circles. If there is a stud, drill a 3/16" hole for lag screws. If there is no stud, drill a 3/4" hole for toggle screws. Make sure to use at least 1 lag screw in a stud and 4 toggle screws in the drywall or the plaster.

Installation Instructions

4 PREPARE THE WALL AND UPPER CABINET (cont.)

Drill the Holes in the Wall and Upper Cabinet (cont.)

- 2 Drill a 3/8" hole at points J and K on the upper cabinet template.

NOTE: If the bottom of the upper cabinet is recessed 3/4" or more, you will need 2" x 2" filler blocks (not included) to provide additional support for the bolts.

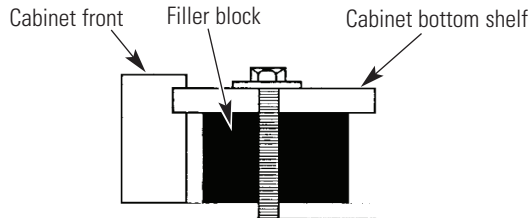

- Mark the center of each filler block and drill a 3/8" diameter hole at the marks.
- Align filler blocks over the two openings in the top of the microwave oven cabinet and attach to the cabinet with masking tape.

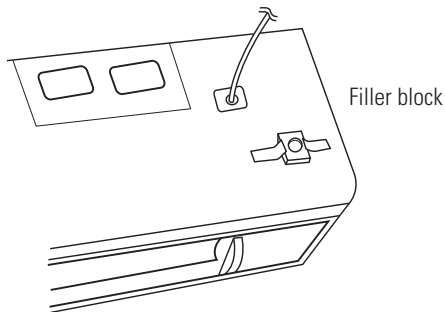

- 3 Cut or drill a 2" diameter hole at the area marked M. Power supply cord hole on the upper cabinet template. If the upper cabinet is metal, you will need to cover the edge of the hole with the power supply cord bushing (supplied) to prevent damage to the cord from the rough metal edge.

- 4 Cut out the venting areas (with the saber saw):

- **Roof-Vented:** Cut out the shaded area marked L on the upper cabinet template.
- **Wall-Vented:** Tape the rear wall template to the rear wall, lining up with the holes previously drilled for holes A and B in the plate. Cut out the shaded area marked F on the REAR WALL TEMPLATE.
- **Room-Vented:** Go to STEP 5, INSTALL THE MOUNTING PLATE, on page 14.

- 5 Complete whichever venting system you have chosen. Use caulking compound to seal the exterior wall or roof opening around the wall cap or roof cap.

5 INSTALL THE MOUNTING PLATE

The Oven Must Be Connected to at Least One Wall Stud.

- 1 Draw a vertical line on the wall at the center of the 30 wide space. Use the mounting plate as the template for the rear wall. Place the mounting plate on the wall, making sure that the tabs are against the bottom of the cabinet. Line up the notch and center line on the mounting plate to the center line on the wall.
- 2 While holding the mounting plate with one hand, draw circles on the wall at holes A, B, C and D. Four holes must be used for mounting. If the holes are not used, the installation will not be secure. Installer must use these holes for proper installation. Use toggle bolts through these holes unless one of them lines up with a stud. Use a wood screw for studs.

NOTE: Draw a fifth circle inside area E, through one of the bottom holes to match the location of a stud.

For wall-vented: The oven requires a rear wall cutout opening for the rear wall duct and the exhaust adapter must be attached to the mounting plate. See the next page on how to prepare the rear wall cutout opening and the exhaust adapter/mounting plate for wall-vented.

- 3 Drill holes on the circles. If there is a stud, drill a 3/16" hole for lag screws. If there is no stud, drill a 5/8" hole for toggle bolts. Make sure to use at least 1 lag screw in a stud, and 4 toggle bolts in the drywall or the plaster.
- 4 Attach the plate to the wall. **To use spring toggle headbolts:** Remove the toggle wings from the bolts. Insert the bolts into the mounting plate and replace the spring toggle head to 3/4" past the bolt ends. Insert the spring toggle head into the holes in the wall to mount the plate. You may pull forward on the plate to help in tightening the toggle bolts. Tighten all bolts.

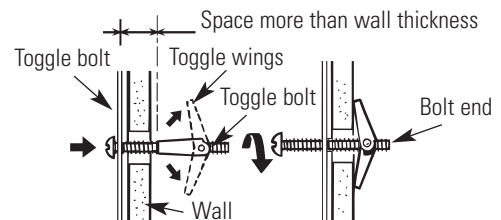

Installation Instructions

5 INSTALL THE MOUNTING PLATE (cont.)

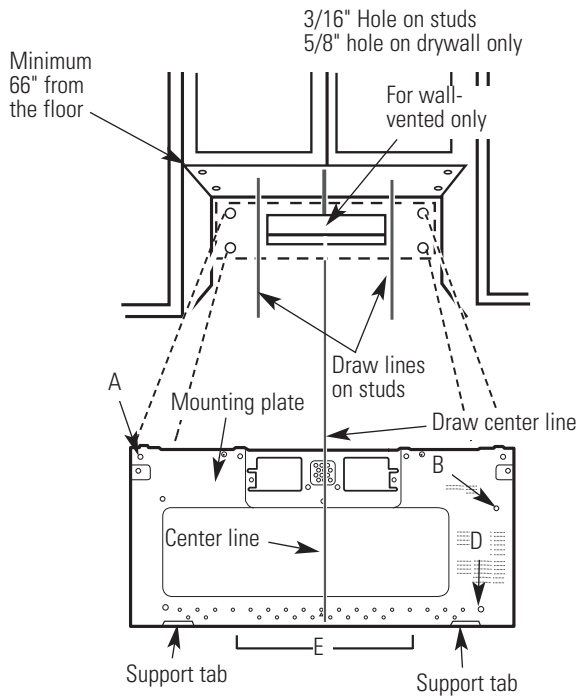

For Wall-Vented

- Make the box cutout for the rear wall duct.

1 piece mounting plate:

Using a pencil, put dots through slots **F** and **G**, and through holes **H** and **I**. Remove the mounting plate and draw lines extending through the points. This will give the location and size of the box cutout for the rear wall duct.

3 pieces mounting plate:

Use the wall template to determine the location and size of the box cutout for the rear wall duct.

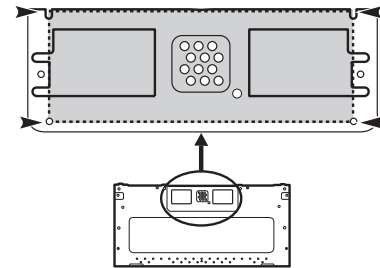

- Attach the exhaust adapter to the rear mounting plate (backplate) wall side. Push in securely until it is past the top locking tabs and in the lower locking tabs. Take care to assure the damper hinge is installed so that it is at the top and that the damper swings freely.
- **Before using the screws to attach the plate to the wall:** Carefully guide the exhaust adapter, now attached to the mounting plate, into the house duct. This will assure proper alignment for installation.
- Return to step 5, item 3 to continue. After completing the installation of the mounting plate, again check the rear damper for free movement to assure it will operate properly.

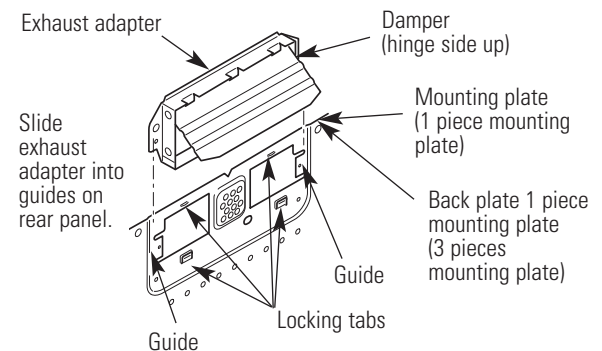

Installation Instructions

6 ATTACH THE OVEN TO THE WALL

⚠ WARNING:

To avoid the risk of personal injury or property damage, you will need two people to install this microwave oven.

- Carefully lift the microwave oven and hang it on the support tabs at the bottom of the mounting plate. Reaching through the upper cabinet, thread the power supply cord through the power supply cord hole in the bottom of the upper cabinet.

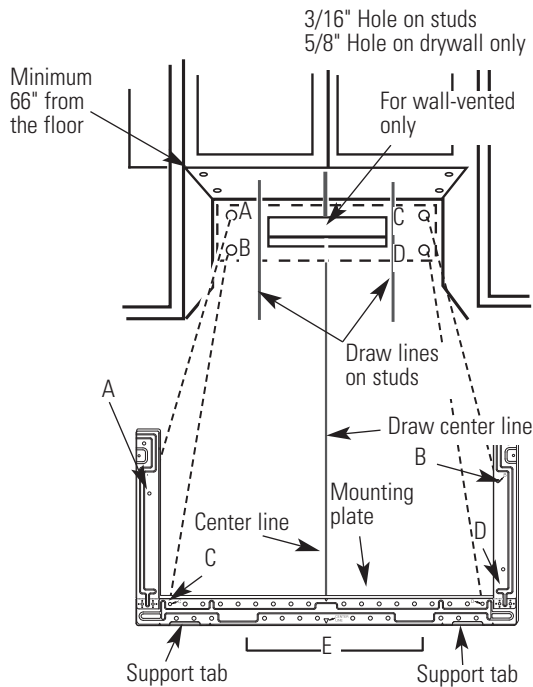

- Rotate the microwave oven upward so the top of oven is against the bottom of the upper cabinet or cabinet frame.

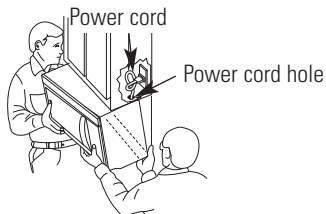

- Then insert a bolt down through each hole in the upper cabinet bottom. Tighten the bolts until the gap between the upper cabinet and the microwave oven is closed.

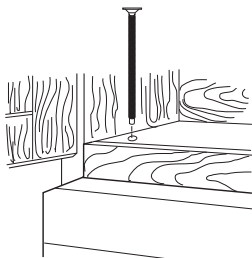

- If wall-vented or room-vented installation is used, go to Step 7.
- Roof venting installation:** Install ductwork through the vent opening in the upper cabinet. Complete the venting system through the roof according to the method needed. See "Prepare The Venting System", STEP 2. Use a caulking gun to seal the exterior roof opening around the exhaust cap. See the Roof-Venting illustration on page 9.

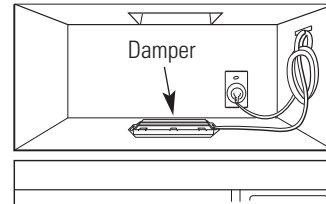

- Use the power supply cord clamp to bundle the power supply cord. Install the power supply cord clamp, using a screw as shown, to the inside of the cabinet.

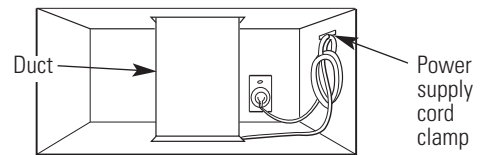

- Grasp the filter screen with one hand holding the ring and the other hand holding the opposite end. Insert the end of the filter screen without the ring into the opening and slide toward the side of the microwave oven. Insert the ring end of the filter screen into the opening and slide the entire screen toward the center of the microwave oven until the screen is securely in position. Repeat for the other filter screen.

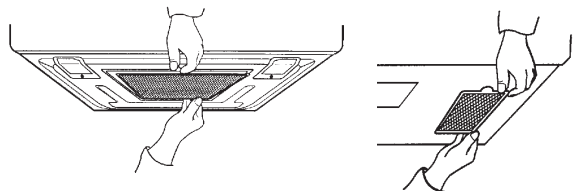

- Plug in the power supply cord.
- Read your Owner's Manual, then check the operation of your microwave oven.

