

This Owner's Manual is provided and hosted by [Appliance Factory Parts](#).



GE HDM1853SJ03 Owner's Manual

[Shop genuine replacement parts for GE HDM1853SJ03](#)



(ART NO. WB13176 C2)

[Find Your GE Microwave Parts - Select From 3055 Models](#)

----- Manual continues below -----



Spacemaker Microwave Oven

Safety Instructions2-9

Operating Instructions

Auto Features20

Care and

Cleaning33, 34

Changing the

Power Level13

Cooking Guide15, 16

Defrosting Guide18

Exhaust Feature37, 38

Features of Your

Microwave Oven11, 12

Microwave Terms32

Other Features25-31

Replacing Bulbs35, 36

Sensor Features21-24

Time Features14-19

Troubleshooting Tips39

Things That Are

Normal With Your

Microwave Oven40

Consumer Support

Consumer

SupportBack Cover

Optional Kits10

Product

Registration41, 42

Warranty43

Español

For a Spanish version of this manual, visit our Website at ge.com.

Para consultar una version en español de este manual de instrucciones, visite nuestro sitio de internet ge.com.

Owner's Manual

JVM1850

JVM1851

JVM1870

JVM1871

JVM2050

JVM3670

HDM1853

EMO4000

Write the model and serial numbers here:

Model # _____

Serial # _____

Find these numbers on a label inside the oven.



IMPORTANT SAFETY INFORMATION. READ ALL INSTRUCTIONS BEFORE USING.

WARNING!

For your safety, the information in this manual must be followed to minimize the risk of fire or explosion, electric shock, or to prevent property damage, personal injury, or loss of life.

PRECAUTIONS TO AVOID POSSIBLE EXPOSURE TO EXCESSIVE MICROWAVE ENERGY

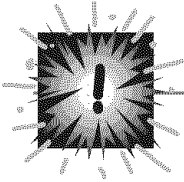

- **Do Not Attempt** to operate this oven with the door open since open-door operation can result in harmful exposure to microwave energy. It is important not to defeat or tamper with the safety interlocks.
- **Do Not Place** any object between the oven front face and the door or allow soil or cleaner residue to accumulate on sealing surfaces.
- **Do Not Operate** the oven if it is damaged. It is particularly important that the oven door close properly and that there is no damage to the:
 - 1 door (bent),
 - 2 hinges and latches (broken or loosened),
 - 3 door seals and sealing surfaces.
- **The Oven Should Not** be adjusted or repaired by anyone except properly qualified service personnel.

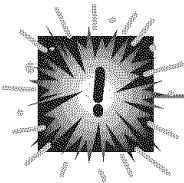

SAFETY PRECAUTIONS

When using electrical appliances, basic safety precautions should be followed, including the following:

- Read and follow the specific precautions in the *Precautions to Avoid Possible Exposure to Excessive Microwave Energy* section above.
- This appliance must be grounded. Connect only to a properly grounded outlet. See the *Grounding Instructions* section on page 8.
- Install or locate this appliance only in accordance with the provided Installation Instructions.
- This microwave oven is intended for household use and is UL listed for installation over electric and gas ranges.
- This microwave oven is not approved or tested for marine use.

Use this appliance only for its intended purpose as described in this Owner's Manual.

- Do not mount this appliance over a sink.
- This over-the-range oven was designed for use over ranges no wider than 36". It may be installed over both gas and electric cooking equipment.
- Do not operate this appliance if it has a damaged power cord or plug, if it is not working properly or if it has been damaged or dropped. If the power cord is damaged, it must be replaced by General Electric Service or an authorized service agent using a power cord available from General Electric.
- Do not cover or block any openings on the appliance.
- Use this appliance only for its intended use as described in this manual. Do not use corrosive chemicals or vapors in this appliance. This microwave oven is specifically designed to heat, dry or cook food, and is not intended for laboratory or industrial use.
- Do not store this appliance outdoors. Do not use this product near water—for example, in a wet basement, near a swimming pool, near a sink or in similar locations.
- Keep power cord away from heated surfaces.
- Do not immerse power cord or plug in water.
- Do not store anything directly on top of the microwave oven surface when the microwave oven is in operation.
- To reduce the risk of fire in the oven cavity:
 - Do not overcook food. Carefully attend appliance when paper, plastic or other combustible materials are placed inside the oven while cooking.
 - Remove wire twist-ties and metal handles from paper or plastic containers before placing them in the oven.
 - Do not use the oven for storage purposes. Do not leave paper products, cooking utensils or food in the oven when not in use.
 - If materials inside the oven ignite, keep the oven door closed, turn the oven off and disconnect the power cord, or shut off power at the fuse or circuit breaker panel. If the door is opened, the fire may spread.
 - Do not use the Sensor Features twice in succession on the same food portion. If food is undercooked after the first countdown, use **Time Cook** for additional cooking time.
- See door surface cleaning instructions in the *Care and cleaning of the microwave oven* section of this manual.
- This appliance should be serviced only by qualified service personnel. Contact nearest authorized service facility for examination, repair or adjustment.
- As with any appliance, close supervision is necessary when used by children.

IMPORTANT SAFETY INFORMATION. READ ALL INSTRUCTIONS BEFORE USING.

⚠ WARNING!



ARCING

If you see arcing, press the **CLEAR/OFF** pad and correct the problem.

Arcing is the microwave term for sparks in the oven. Arcing is caused by:

- The metal shelf not installed correctly so it touches the microwave wall.
- Metal or foil touching the side of the oven.
- Foil not molded to food (upturned edges act like antennas).
- Metal, such as twist-ties, poultry pins or gold-rimmed dishes, in the microwave.
- Recycled paper towels containing small metal pieces being used in the microwave.



FOODS

- Do not pop popcorn in your microwave oven unless in a special microwave popcorn accessory or unless you use popcorn labeled for use in microwave ovens.
- Some products such as whole eggs and sealed containers—for example, closed jars—are able to explode and should not be heated in this microwave oven. Such use of the microwave oven could result in injury.
- Do not boil eggs in a microwave oven. Pressure will build up inside egg yolk and will cause it to burst, possibly resulting in injury.
- Operating the microwave with no food inside for more than a minute or two may cause damage to the oven and could start a fire. It increases the heat around the magnetron and can shorten the life of the oven.
- Foods with unbroken outer “skin” such as potatoes, hot dogs, sausages, tomatoes, apples, chicken livers and other giblets, and egg yolks should be pierced to allow steam to escape during cooking.

■ **SUPERHEATED WATER**

Liquids, such as water, coffee or tea are able to be overheated beyond the boiling point without appearing to be boiling. Visible bubbling or boiling when the container is removed from the microwave oven is not always present. THIS COULD RESULT IN VERY HOT LIQUIDS SUDDENLY BOILING OVER WHEN THE CONTAINER IS DISTURBED OR A SPOON OR OTHER UTENSIL IS INSERTED INTO THE LIQUID.

To reduce the risk of injury to persons:

- Do not overheat the liquid.
- Stir the liquid both before and halfway through heating it.
- Do not use straight-sided containers with narrow necks.
- After heating, allow the container to stand in the microwave oven for a short time before removing the container.
- Use extreme care when inserting a spoon or other utensil into the container.

■ Avoid heating baby food in glass jars, even with the lid off. Make sure all infant food is thoroughly cooked. Stir food to distribute the heat evenly. Be careful to prevent scalding when warming formula or breast milk. The container may feel cooler than the milk really is. Always test the milk before feeding the baby.

■ Don't defrost frozen beverages in narrow-necked bottles (especially carbonated beverages). Even if the container is opened, pressure can build up. This can cause the container to burst, possibly resulting in injury.

■ Hot foods and steam can cause burns. Be careful when opening any containers of hot food, including popcorn bags, cooking pouches and boxes. To prevent possible injury, direct steam away from hands and face.

■ Do not overcook potatoes. They could dehydrate and catch fire, causing damage to your oven.

■ Cook meat and poultry thoroughly—meat to at least an INTERNAL temperature of 160°F and poultry to at least an INTERNAL temperature of 180°F. Cooking to these temperatures usually protects against food-borne illness.

IMPORTANT SAFETY INFORMATION. READ ALL INSTRUCTIONS BEFORE USING.

⚠ WARNING!



MICROWAVE-SAFE COOKWARE

Make sure all cookware used in your microwave oven is suitable for microwaving. Most glass casseroles, cooking dishes, measuring cups, custard cups, pottery or china dinnerware which does not have metallic trim or glaze with a metallic sheen can be used. Some cookware is labeled "suitable for microwaving."

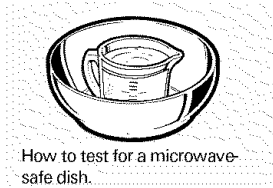

How to test for a microwave-safe dish.

- If you are not sure if a dish is microwave-safe, use this test: Place in the oven both the dish you are testing and a glass measuring cup filled with 1 cup of water—set the measuring cup either in or next to the dish. Microwave 30–45 seconds at high. If the dish heats, it should not be used for microwaving.
- If the dish remains cool and only the water in the cup heats, then the dish is microwave-safe.
- If you use a meat thermometer while cooking, make sure it is safe for use in microwave ovens.
- Do not use recycled paper products. Recycled paper towels, napkins and waxed paper can contain metal flecks which may cause arcing or ignite. Paper products containing nylon or nylon filaments should be avoided, as they may also ignite.
- Some styrofoam trays (like those that meat is packaged on) have a thin strip of metal embedded in the bottom. When microwaved, the metal can burn the floor of the oven or ignite a paper towel.
- Do not use the microwave to dry newspapers.
- Not all plastic wrap is suitable for use in microwave ovens. Check the package for proper use.
- Paper towels, waxed paper and plastic wrap can be used to cover dishes in order to retain moisture and prevent spattering. Be sure to vent plastic wrap so steam can escape.
- Cookware may become hot because of heat transferred from the heated food. Pot holders may be needed to handle the cookware.

- “Boilable” cooking pouches and tightly closed plastic bags should be slit, pierced or vented as directed by package. If they are not, plastic could burst during or immediately after cooking, possibly resulting in injury. Also, plastic storage containers should be at least partially uncovered because they form a tight seal. When cooking with containers tightly covered with plastic wrap, remove covering carefully and direct steam away from hands and face.
- Use foil only as directed in this manual. When using foil in the microwave oven, keep the foil at least 1” away from the sides of the oven.
- Plastic cookware – Plastic cookware designed for microwave cooking is very useful, but should be used carefully. Even microwave-safe plastic may not be as tolerant of overcooking conditions as are glass or ceramic materials and may soften or char if subjected to short periods of overcooking. In longer exposures to overcooking, the food and cookware could ignite.

Follow these guidelines:

 - 1 Use microwave-safe plastics only and use them in strict compliance with the cookware manufacturer’s recommendations.
 - 2 Do not microwave empty containers.
 - 3 Do not permit children to use plastic cookware without complete supervision.

IMPORTANT SAFETY INFORMATION. READ ALL INSTRUCTIONS BEFORE USING.

⚠ WARNING!

Improper use of the grounding plug can result in a risk of electric shock.



GROUNDING INSTRUCTIONS

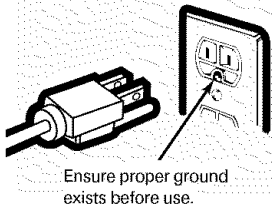

Ensure proper ground exists before use.

This appliance must be grounded. In the event of an electrical short circuit, grounding reduces the risk of electric shock by providing an escape wire for the electric current.

This appliance is equipped with a power cord having a grounding wire with a grounding plug. The

plug must be plugged into an outlet that is properly installed and grounded.

Consult a qualified electrician or service technician if the grounding instructions are not completely understood, or if doubt exists as to whether the appliance is properly grounded.

If the outlet is a standard 2-prong wall outlet, it is your personal responsibility and obligation to have it replaced with a properly grounded 3-prong wall outlet.

Do not under any circumstances cut or remove the third (ground) prong from the power cord.

Do not use an adapter plug with this appliance.

Do not use an extension cord with this appliance. If the power cord is too short, have a qualified electrician or service technician install an outlet near the appliance.

For best operation, plug this appliance into its own electrical outlet to prevent flickering of lights, blowing of fuse or tripping of circuit breaker.

THE VENT FAN

The fan will operate automatically under certain conditions (see Automatic Fan feature). Take care to prevent the starting and spreading of accidental cooking fires while the vent fan is in use.

- Clean the underside of the microwave often. Do not allow grease to build up on the microwave or the fan filter.
- In the event of a grease fire on the surface units below the microwave oven, smother a flaming pan on the surface unit by covering the pan completely with a lid, a cookie sheet or a flat tray.
- Use care when cleaning the vent fan filter. Corrosive cleaning agents, such as lye-based oven cleaners, may damage the filter.
- When preparing flaming foods under the microwave, turn the fan on.
- Never leave surface units beneath your microwave oven unattended at high heat settings. Boilovers cause smoking and greasy spillovers that may ignite and spread if the microwave vent fan is operating. To minimize automatic fan operation, use adequate-sized cookware and use high heat on surface units only when necessary.



READ AND FOLLOW THIS SAFETY INFORMATION CAREFULLY.

SAVE THESE INSTRUCTIONS

About optional kits.

OPTIONAL KITS

Filler Panel Kits

JX52WH – White

JX52BL – Black

When replacing a 36" range hood, filler panel kits fill in the additional width to provide a custom built-in appearance.

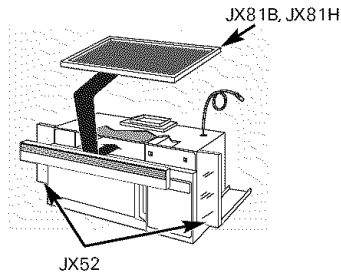

For installation between cabinets only; not for end-of-cabinet installation. Each kit contains two 3"-wide filler panels.

Filter Kits

JX81B – Recirculating Charcoal Filter Kit (1800 and 3600 Series models)

JX81H – Recirculating Charcoal Filter Kit (2000 Series models)

Filter kits are used when the microwave oven cannot be vented to the outside.

Available at extra cost from your GE supplier. See the back cover for ordering by phone or at ge.com.

About the features of your microwave oven.

ge.com

Throughout this manual, features and appearance may vary from your model.

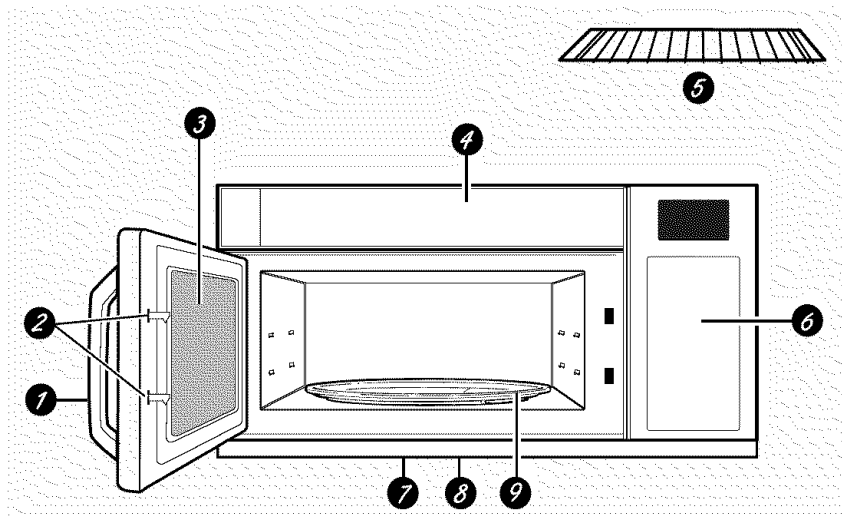

Features of the Oven

- 1 Door Handle.** Pull to open the door. The door must be securely latched for the microwave to operate.
- 2 Door Latches.**
- 3 Window with Metal Shield.** Screen allows cooking to be viewed while keeping microwaves confined in the oven.
- 4 Active Vent (on some models).** The vent door swings open when the fan operates and closes when the fan shuts off.
- 5 Shelf.** Lets you microwave several foods at once. Food microwaves best when placed directly on the turntable.
- 6 Touch Control Panel Display.**
- 7 Cooktop Light.**
- 8 Grease Filter.**
- 9 Removable Turntable.** Turntable and support **must** be in place when using the oven. The turntable may be removed for cleaning.

NOTE: Rating plate is located on the inside wall of the microwave, or on the upper left front behind the door. Oven vent(s) and oven light are located on the inside walls of the microwave oven.

Safety Instructions

Operating Instructions

Troubleshooting Tips

Consumer Support

About the features of your microwave oven.

You can microwave by time, with the sensor features or with the auto features.

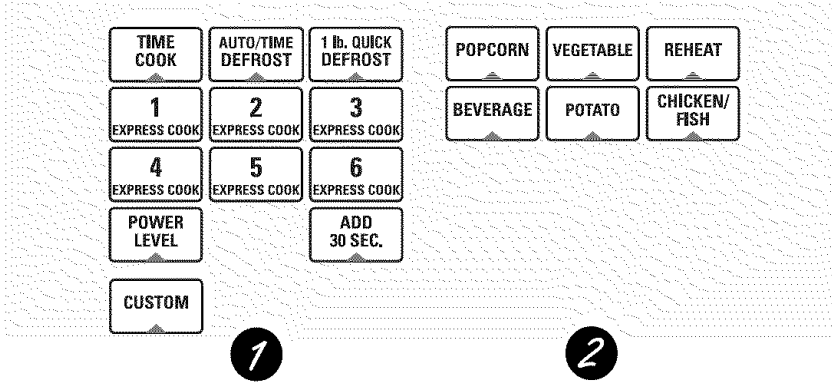

Cooking Controls

1 Time and Auto Features

Press	Enter
TIME COOK I & II Press once or twice	Amount of cooking time
AUTO/TIME DEFROST Press twice	Amount of defrosting time
CUSTOM (on some models)	Follow displayed instructions
EXPRESS COOK	Starts immediately!
ADD 30 SEC	Starts immediately!
POWER LEVEL	Power level 1–10
AUTO/TIME DEFROST Press once	Food weight up to 6 lbs.
1 lb. QUICK DEFROST	Starts immediately!

2 Sensor Features

Press	Enter	Option
POPCORN	Starts immediately!	more/less time
BEVERAGE	Starts immediately!	
REHEAT	Starts immediately!	more/less time
POTATO	Starts immediately!	more/less time
VEGETABLE	Starts immediately!	
Press once (fresh vegetables)		more/less time
Press twice (frozen vegetables)		more/less time
Press three times (canned vegetables)		more/less time (on some models)
CHICKEN/FISH (on some models) Press once (chicken pieces) Press twice (fish)	Starts immediately!	more/less time

About changing the power level.

ge.com

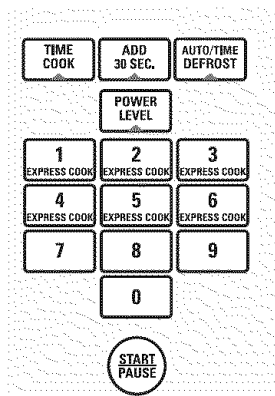

Variable power levels add flexibility to microwave cooking. The power levels on the microwave oven can be compared to the surface units on a range. High (power level 10) or full power is the fastest way to cook and gives you 100% power. Each power level gives you microwave energy a certain percent of the time. Power level 7 is microwave energy 70% of the time. Power level 3 is energy 30% of the time.

A high setting (10) will cook faster but food may need more frequent stirring, rotating or turning over. Most cooking will be done on High (power level 10). A lower setting will cook more evenly and need less stirring or rotating of the food.

Some foods may have better flavor, texture or appearance if one of the lower settings is used. Use a lower power level when cooking foods that have a tendency to boil over, such as scalloped potatoes.

Rest periods (when the microwave energy cycles off) give time for the food to “equalize” or transfer heat to the inside of the food. An example of this is shown with power level 3—the defrost cycle. If microwave energy did not cycle off, the outside of the food would cook before the inside was defrosted.

Here are some examples of uses for various power levels:

Power Level	Best Uses
High 10	Fish, bacon, vegetables, boiling liquids.
Med-High 7	Gentle cooking of meat and poultry; baking casseroles and reheating.
Medium 5	Slow cooking and tenderizing such as stews and less tender cuts of meat.
Low 2 or 3	Defrosting without cooking; simmering; delicate sauces.
Warm 1	Keeping food warm without overcooking; softening butter.

How to Change the Power Level

The power level may be entered or changed immediately after entering the feature time for **TIME COOK**, **TIME DEFROST**, **EXPRESS COOK** or **ADD 30 SEC.**

The power level may also be changed during time countdown.

- 1 Press **TIME COOK** or select **Time Defrost**.
- 2 Enter cooking or defrosting time.
- 3 Press **POWER LEVEL**.
- 4 Select desired power level 1–10.
- 5 Press **START**.

Safety Instructions

Operating Instructions

Troubleshooting Tips

Consumer Support

About the time features.

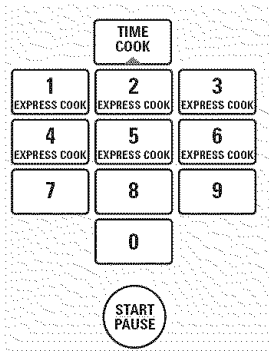

Time Cook I

Allows you to microwave for any time up to 99 minutes and 99 seconds.

Power level 10 (High) is automatically set, but you may change it for more flexibility.

You may open the door during **TIME COOK** to check the food. Close the door and press **START** to resume cooking.

Time Cook II

Lets you change power levels automatically during cooking. Here's how to do it:

- 1 Press **TIME COOK**.
- 2 Enter cooking time.
- 3 Change power level if you don't want full power. (Press **POWER LEVEL**. Select a desired power level 1-10.)
- 4 Press **START**.

- 1 Press **TIME COOK**.
- 2 Enter the first cook time.
- 3 Change the power level if you don't want full power. (Press **POWER LEVEL**. Select a desired power level 1-10.)
- 4 Press **TIME COOK** again.
- 5 Enter the second cook time.
- 6 Change the power level if you don't want full power. (Press **POWER LEVEL**. Select a power level 1-10.)
- 7 Press **START**.

At the end of **Time Cook I**, **Time Cook II** counts down.

Cooking Guide for Time Cook I and Time Cook II

NOTE: Use power level High (10) unless otherwise noted.

Vegetable	Amount	Time	Comments
Asparagus			
(fresh spears)	1 lb.	6 to 9 min., Med-High (7)	In 1½-qt. oblong glass baking dish, place 1/4 cup water.
(frozen spears)	10-oz package	5 to 7 min.	In 1-qt. casserole.
Beans			
(fresh green)	1 lb. cut in half	9 to 11 min.	In 1½-qt. casserole, place 1/2 cup water.
(frozen green)	10-oz package	6 to 8 min.	In 1-qt. casserole, place 2 tablespoons water.
(frozen lima)	10-oz package	6 to 8 min.	In 1-qt. casserole, place 1/4 cup water.
Beets			
(fresh, whole)	1 bunch	17 to 21 min.	In 2-qt. casserole, place 1/2 cup water.
Broccoli			
(fresh cut)	1 bunch (1¼ to 1½ lbs.)	7 to 10 min.	In 2-qt. casserole, place 1/2 cup water.
(fresh spears)	1 bunch (1¼ to 1½ lbs.)	9 to 13 min.	In 2-qt. oblong glass baking dish, place 1/4 cup water.
(frozen, chopped)	10-oz package	5 to 7 min.	In 1-qt. casserole.
(frozen spears)	10-oz package	5 to 7 min.	In 1-qt. casserole, place 3 tablespoons water.
Cabbage			
(fresh)	1 medium head (about 2 lbs.)	8 to 11 min.	In 1½- or 2-qt. casserole, place 1/4 cup water.
(wedges)		7 to 10 min.	In 2- or 3-qt. casserole, place 1/4 cup water.
Carrots			
(fresh, sliced)	1 lb.	7 to 9 min.	In 1½-qt. casserole, place 1/4 cup water.
(frozen)	10-oz package	5 to 7 min.	In 1-qt. casserole, place 2 tablespoons water.
Cauliflower			
(flowerets)	1 medium head	9 to 14 min.	In 2-qt. casserole, place 1/2 cup water.
(fresh, whole)	1 medium head	10 to 17 min.	In 2-qt. casserole, place 1/2 cup water.
(frozen)	10-oz package	5 to 7 min.	In 1-qt. casserole, place 2 tablespoons water.

About the time features.

Vegetable	Amount	Time	Comments
Corn			
(frozen kernel)	10-oz package	5 to 7 min.	In 1-qt. casserole, place 2 tablespoons water.
Corn on the cob			
(fresh)	1 to 5 ears	3 to 4 min. per ear	In 2-qt. oblong glass baking dish, place corn. If corn is in husk, use no water; if corn has been husked, add 1/4 cup water. Rearrange after half of time.
(frozen)	1 ear	5 to 6 min.	Place in 2-qt. oblong glass baking dish.
	2 to 6 ears	3 to 4 min. per ear	Cover with vented plastic wrap. Rearrange after half of time.
Mixed vegetables			
(frozen)	10-oz package	5 to 7 min.	In 1-qt. casserole, place 3 tablespoons water.
Peas			
(fresh, shelled)	2 lbs. unshelled	9 to 12 min.	In 1-qt. casserole, place 1/4 cup water.
(frozen)	10-oz package	5 to 7 min.	In 1-qt. casserole, place 2 tablespoons water.
Potatoes			
(fresh, cubed, white)	4 potatoes (6 to 8 oz each)	9 to 12 min.	Peel and cut into 1 inch cubes. Place in 2-qt. casserole with 1/2 cup water. Stir after half of time.
(fresh, whole, sweet or white)	1 (6 to 8 oz)	3 to 4 min.	Pierce with cooking fork. Place in center of the oven. Let stand 5 minutes.
Spinach			
(fresh)	10 to 16 oz	5 to 7 min.	In 2-qt. casserole, place washed spinach.
(frozen, chopped and leaf)	10-oz package	5 to 7 min.	In 1-qt. casserole, place 3 tablespoons water.
Squash			
(fresh, summer and yellow)	1 lb. sliced	5 to 7 min.	In 1½-qt. casserole, place 1/4 cup water.
(winter, acorn, butternut)	1 to 2 squash (about 1 lb. each)	8 to 11 min.	Cut in half and remove fibrous membranes. In 2-qt. oblong glass baking dish, place squash cut-side-down. Turn cut-side-up after 4 minutes.

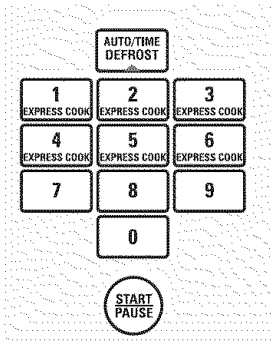

- 1 Press **AUTO/TIME DEFROST** twice.
- 2 Enter defrosting time.
- 3 Press **START**.

Time Defrost

Allows you to defrost for the length of time you select. See the Defrosting Guide for suggested times.

Power level 3 is automatically set, but you may change this for more flexibility. You may defrost small items more quickly by raising the power level after entering the time. However, they will need more frequent attention than usual.

Power level 7 cuts the total defrosting time in about half; power level 10 cuts the total time to approximately 1/3. Rotate or stir food frequently.

A dull thumping noise may be heard during defrosting. This sound is normal when the oven is not operating at High power.

Defrosting Tips

- For best results, place food directly on the defrost rack and place the rack on the turntable.
- Foods frozen in paper or plastic can be defrosted in the package. Tightly closed packages should be slit, pierced or vented **AFTER** food has partially defrosted. Plastic storage containers should be at least partially uncovered.
- Family-size, prepackaged frozen dinners can be defrosted and microwaved. If the food is in a foil container, transfer it to a microwave-safe dish.
- Foods that spoil easily, such as milk, eggs, fish, stuffings, poultry and pork should not be allowed to sit out for more than one hour after defrosting. Room temperature promotes the growth of harmful bacteria.
- For more even defrosting of larger foods, such as beef, lamb and veal roasts, use **Auto Defrost**.
- Be sure large meats are completely defrosted before cooking.
- When defrosted, food should be cool but softened in all areas. If still slightly icy, return to the microwave very briefly, or let it stand a few minutes.

About the time features.

Defrosting Guide

Food	Time	Comments
Breads, Cakes		
Bread, buns or rolls (1 piece)	1 min.	
Sweet rolls (approx. 12 oz)	3 to 5 min.	
Fish and Seafood		
Fillets, frozen (1 lb.)	6 to 8 min.	
Shellfish, small pieces (1 lb.)	5 to 7 min.	Place block in casserole. Turn over and break up after half the time.
Fruit		
Plastic pouch – 1 to 2 (10-oz package)	3 to 6 min.	
Meat		
Bacon (1 lb.)	2 to 5 min.	Place unopened package in oven. Let stand 5 minutes after defrosting.
Franks (1 lb.)	2 to 5 min.	Place unopened package in oven. Microwave just until franks can be separated. Let stand 5 minutes, if necessary, to complete defrosting.
Ground meat (1 lb.)	5 to 7 min.	Turn meat over after half the time.
Roast: beef, lamb, veal, pork per lb.	12 to 16 min.	Use power level 1.
Steaks, chops and cutlets per lb.	5 to 7 min.	Place unwrapped meat in cooking dish. Turn over after half the time and shield warm areas with foil. When finished, separate pieces and let stand to complete defrosting.
Poultry		
Chicken, broiler-fryer cut up (2½ to 3 lbs.)	15 to 19 min.	Place wrapped chicken in dish. Unwrap and turn over after half the time. When finished, separate pieces and microwave 2 to 4 minutes more, if necessary. Let stand to finish defrosting.
Chicken, whole (2½ to 3 lbs.)	17 to 21 min.	Place wrapped chicken in dish. After half the time, unwrap and turn chicken over. Shield warm areas with foil. Finish defrosting. If necessary, run cold water in the cavity until giblets can be removed.
Cornish hen per lb.	7 to 13 min.	Place unwrapped hen in the oven breast-side-up. Turn over after half the time. Run cool water in the cavity until giblets can be removed.
Turkey breast (4 to 6 lbs.) per lb.	5 to 9 min.	Place unwrapped breast in dish breast-side-down. After half the time, turn over and shield warm areas with foil. Finish defrosting. Let stand 1 to 2 hours in refrigerator to complete defrosting.

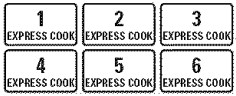

Express Cook

This is a quick way to set cooking time for 1–6 minutes.

Press one of the **Express Cook** pads (from 1 to 6) for 1 to 6 minutes of cooking at **power level 10**.

For example, press the **2** pad for 2 minutes of cooking time.

The power level can be changed as time is counting down. Press **POWER LEVEL** and enter 1–10.



Add 30 Seconds

You can use this feature two ways:

- It will add 30 seconds to the time counting down each time the pad is pressed.
- It can be used as a quick way to set 30 seconds of cooking time.

About the auto features.

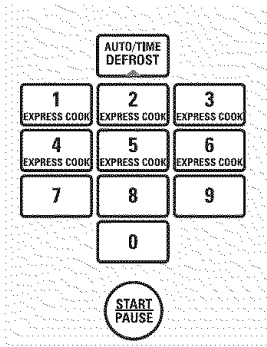

1 Press **AUTO/TIME DEFROST** once for **Auto Defrost**.

2 Using the Conversion Guide at right, enter food weight. For example, press pads 1 and 2 for 1.2 pounds (1 pound, 3 ounces). Enter weight up to 6 pounds for **Auto Defrost**.

3 Press **START**.

Auto Defrost

Auto Defrost automatically sets the defrosting times and power levels to give even defrosting results for meats, poultry and fish weighing up to six pounds.

- For best results, remove food from the package, place food directly on the defrost rack and place the rack on the turntable.
- Twice during **Auto Defrost**, the oven signals **Turn Food Over**. At each signal, turn the food over. Remove defrosted meat or shield warm areas with small pieces of foil.
- After defrosting, most meats need to stand 5 minutes to complete defrosting. Large roasts should stand for about 30 minutes.

Conversion Guide

If the weight of food is stated in pounds and ounces, the ounces must be converted to tenths (.1) of a pound.

Weight of Food in Ounces	Enter Food Weight (tenths of a pound)	Weight of Food in Ounces	Enter Food Weight (tenths of a pound)
1-2	.1	9-10	.6
3	.2	11	.7
4-5	.3	12-13	.8
6-7	.4	14-15	.9
8	.5		

1 lb. QUICK DEFROST

1 lb. Quick Defrost

1 lb. Quick Defrost automatically sets the defrosting times and power levels for foods weighing one pound.

Press **1 lb. Quick Defrost**. The oven starts automatically. When the oven signals, turn food over.

- For best results, remove food from the package, place food directly on the defrost rack and place the rack on the turntable.

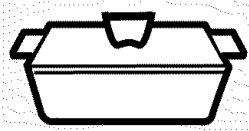

Covered

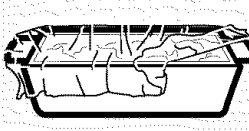

Vented

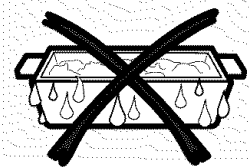

Dry off dishes so they don't mislead the sensor.

Humidity Sensor

What happens when using the Sensor Features:

The Sensor Features detect the increasing humidity released during cooking. The oven automatically adjusts the cooking time to various types and amounts of food.

Do not use the Sensor Features twice in succession on the same food portion—it may result in severely overcooked or burnt food. If food is undercooked after the countdown, use **Time Cook** for additional cooking time.

The proper containers and covers are essential for best sensor cooking.

Always use microwave-safe containers and cover them with lids or vented plastic wrap. Never use tight sealing plastic containers—they can prevent steam from escaping and cause food to overcook.

Be sure the outside of the cooking containers and the inside of the microwave oven are dry before placing food in the oven. Beads of moisture turning into steam can mislead the sensor.



Beverage

Press **BEVERAGE** once to heat an 8–10 oz cup of coffee or other beverage.

Drinks heated with the Beverage feature may be very hot. Remove the container with care.

If food is undercooked after the countdown use **Time Cook** for additional cooking time.

NOTE: Do not use this feature twice in succession on the same food portion—it may result in severely overcooked or burnt food.

About the sensor features.

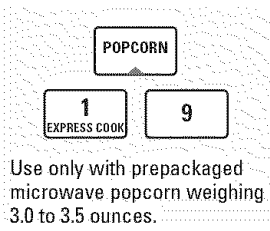

NOTE: Do not use the metal shelf when using the **Popcorn** feature.

NOTE: Do not use this feature twice in succession on the same food portion—it may result in severely overcooked or burnt food.

Popcorn

How to Use the Popcorn Feature

- 1 Follow package instructions, using **Time Cook** if the package is less than 3.0 ounces or larger than 3.5 ounces. Place the package of popcorn in the center of the microwave.
- 2 Press **POPCORN** for a regular size (3.0 to 3.5 oz) bag of popcorn. The oven starts immediately.

If you open the door while **POPCORN** is displayed, an error message will appear. Close the door and press **START**.

If food is undercooked after the countdown use **Time Cook** for additional cooking time.

How to Adjust the Popcorn Program to Provide a Shorter or Longer Cook Time

If you find that the brand of popcorn you use underpops or overcooks consistently, you can add or subtract 20–30 seconds to the automatic popping time.

To add time:

After pressing **POPCORN**, press **9** within the first 30 seconds after the oven starts for an extra 20 seconds.

Press **9** again to add another 10 seconds (total 30 seconds additional time).

To subtract time:

After pressing **POPCORN**, press **1** within the first 30 seconds after the oven starts for 20 seconds less cooking time.

Press **1** again to reduce cooking time another 10 seconds (total 30 seconds less time).

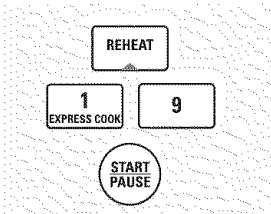

For reheating single servings of previously cooked foods or a plate of leftovers.

NOTE: Do not use the metal shelf when using the **Reheat** feature.

NOTE: Do not use this feature twice in succession on the same food portion—it may result in severely overcooked or burnt food.

Reheat

How to Use the Reheat feature:

- 1 Place the cup of liquid or covered food in the oven. Press **REHEAT** once, twice or three times. The oven starts immediately. Press once for a plate of leftovers. Press twice for pasta (8–12 oz). Press three times for vegetables (1/2 to 2 cups).
- 2 The oven signals when steam is sensed and the time remaining begins counting down.

Do not open the oven door until time is counting down. If the door is opened, close it and press **START** immediately.

After removing food from the oven, stir, if possible, to even out the temperature. Reheated foods may have wide variations in temperature. Some areas may be extremely hot.

If food is not hot enough after the countdown use **Time Cook** for additional reheating time.

How to Change the Automatic Settings:

To reduce time by 10%:

Press **1** within 30 seconds after pressing the **REHEAT** pad.

To add 10% to cooking time:

Press **9** within 30 seconds after pressing the **REHEAT** pad.

Some Foods Not Recommended For Use With Reheat:

It is best to use **Time Cook** for these foods:

- Bread products.
- Foods that must be reheated uncovered.
- Foods that need to be stirred or rotated.
- Foods calling for a dry look or crisp surface after reheating.

About the sensor features.

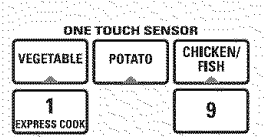

Sensor cooking gives you easy, automatic results with a variety of foods (see the Cooking Guide below).

NOTE: Do not use the metal shelf with Sensor Cooking.

NOTE: Do not use this feature twice in succession on the same food portion—it may result in severely overcooked or burnt food.

Sensor Cooking

(Fish and Chicken Pieces on some models)

- 1 Place covered food in the oven. Press the food pad. For vegetables, press the **VEGETABLE** pad once for fresh vegetables, twice for frozen vegetables or three times for canned vegetables. For chicken or fish, press the **CHICKEN/FISH** pad once for chicken pieces or twice for fish. The oven starts immediately.
- 2 The oven signals when steam is sensed and the time remaining begins counting down. Turn or stir the food if necessary.

Do not open the oven door until time is counting down. If the door is opened, close it and press **START** immediately.

If food is undercooked after the countdown use **Time Cook** for additional cooking time.

How to Change the Automatic Settings (automatic settings for canned vegetables cannot be adjusted on some models):

You can adjust the cooking time for all foods to suit your personal taste.

To reduce time by 10%:

Press **1** within 30 seconds after pressing the food pad.

To add 10% to cooking time:

Press **9** within 30 seconds after pressing the food pad.

Cooking Guide

Food Type	Amount	Comments
Canned Vegetables	4–16 oz	Cover with lid or vented plastic wrap.
Frozen Vegetables	4–16 oz	Follow package instructions for adding water. Cover with lid or vented plastic wrap.
Fresh Vegetables	4–16 oz	Add 1/4 cup water per serving. Cover with lid or vented plastic wrap.
Potatoes	8–32 oz	Pierce skin with fork. Place potatoes on the turntable.
Fish*	4–16 oz	Cover with vented plastic wrap.
Chicken Pieces*	2–8 pieces	Cover with vented plastic wrap.

*On some models

Other features your model may have.

ge.com

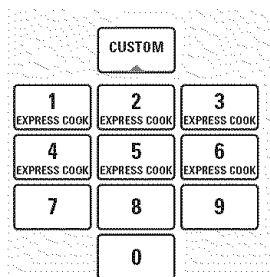

Custom

The **CUSTOM** pad allows you to save your most frequently used settings. (Sensor cooking settings cannot be saved.)

To set and save a setting:

- 1 Press the **CUSTOM** pad.
- 2 Set the amount of cooking time.
- 3 Set the power level, if desired. (Full power will automatically be set if you do not change it.)
- 4 Press the **CUSTOM** pad.

Your custom setting will be remembered for future one touch use.

To clear the custom setting, press and hold the **CUSTOM** pad for 2 seconds.



Help

The **HELP** pad displays feature information and helpful hints. Press **HELP**; then select a feature pad.

Cooking Complete Reminder

To remind you that you have food in the oven, the oven will display **FOOD IS READY** and beep once a minute until you either open the oven door or press **CLEAR/OFF**.

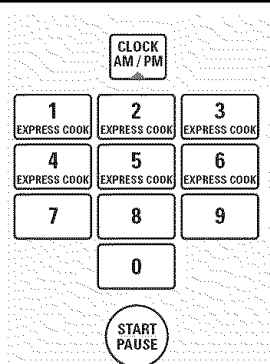

Clock

Press **CLOCK** to set the time of day.

- 1 Press **CLOCK**.
- 2 Enter the time of day.
- 3 Select AM or PM.
- 4 Press **START**.

To check the time of day while microwaving, press **CLOCK**.

Other features your model may have.

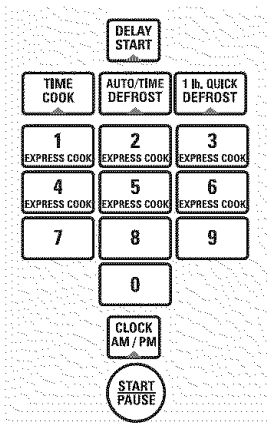

Delay Start

Delay Start allows you to set the microwave to delay cooking up to 24 hours.

- 1 Press **DELAY START**.
- 2 Select the cooking or defrosting feature you wish to delay; then enter the cooking or defrosting time.
- 3 Press **START**.
- 4 Enter the time you want the oven to start. (Be sure the microwave clock shows the correct time of day.)
- 5 Select AM or PM.
- 6 Press **START**.

The start time will be displayed and will remain until the oven automatically starts at the delayed time.

The time of day may be displayed by pressing **CLOCK**.

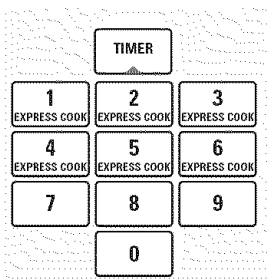

Timer

Timer operates as a minute timer and can be used at any time, even when the oven is operating.

- 1 Press **TIMER**.
- 2 Enter time you want to count down.
- 3 Press **TIMER** to start.

To pause the countdown, press **TIMER**.

When time is up, the oven will signal. To turn off the timer signal, press **TIMER**.

NOTE: The timer indicator will be lit while the timer is operating.

To cancel the timer, press and hold the **TIMER** pad for 2 seconds.

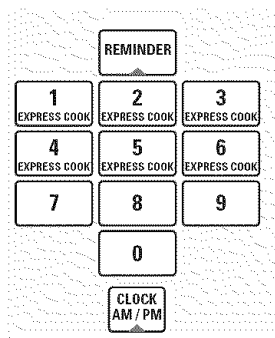

Reminder

The **Reminder** feature can be used like an alarm clock, and can be used at any time, even when the oven is operating. The **Reminder** time can be set up to 24 hours later.

- 1 Press **REMINDER**.
- 2 Enter the time you want the oven to remind you. (Be sure the microwave clock shows the correct time of day.)
- 3 Select AM or PM.
- 4 Press **REMINDER**. When **Reminder** signal occurs, press **REMINDER** to turn it off. The **Reminder** time may be displayed by pressing **REMINDER**.

NOTE: The **REM** indicator will remain lit to show that the **Reminder** is set. To clear the **Reminder** before it occurs, press and hold the **REMINDER** pad for 2 seconds.



Start/Pause

In addition to starting many functions, **START/PAUSE** allows you to stop cooking without opening the door or clearing the display.



Child Lock-Out

You may lock the control panel to prevent the microwave from being accidentally started or used by children.

To lock or unlock the controls, press and hold **CLEAR/OFF** for about three seconds. When the control panel is locked, **CONTROL LOCKED** or **LOCKED** will be displayed.

Other features your model may have.

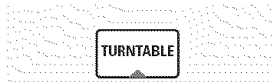

Turntable

For best cooking results, leave the turntable on. It can be turned off for large dishes. Press **TURNTABLE** to turn the turntable on or off.

Sometimes the turntable can become too hot to touch. Be careful touching the turntable during and after cooking.



Vent Fan

The vent fan removes steam and other vapors from surface cooking.



Press **VENT FAN** once for high fan speed, twice for medium fan speed, a third time for low fan speed or a fourth time to turn the fan off.

Press the **VENT FAN BOOST** pad (on some models) for extra fan speed.

Automatic Fan

An automatic fan feature protects the microwave from too much heat rising from the cooktop below it. It automatically turns on if it senses too much heat.

If you have turned the fan on, you may find that you cannot turn it off. The fan will automatically turn off when the internal parts are cool. It may stay on for 30 minutes or more after the cooktop and microwave controls are turned off.



Surface Light

Press **SURFACE LIGHT** once for bright light, twice for the night light, or three times to turn the light off.

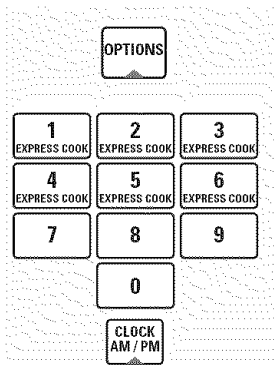

Options

Press the **OPTIONS** pad multiple times to cycle through the available options.

Auto Nite Light

The **Auto Nite Light** can be set to come on and go off at desired times.

To set the timer:

- 1** Press **1**.
- 2** Enter the time of day for the light to come on.
- 3** Select AM or PM.
- 4** Press the **OPTIONS** pad.
- 5** Enter the time of day for the light to go off.
- 6** Select AM or PM.
- 7** Press the **OPTIONS** pad.

To review the nite light settings, press **2** after selecting the **Auto Nite Light** option.

To turn the nite light off, press **0** after selecting the **Auto Nite Light** option.

Beeper Volume

The beeper sound level can be adjusted. Choose 0–3 for mute to loud.

Charcoal Filter Reminder

The **Charcoal Filter Reminder** is a 180-day timer to remind you when to change the charcoal filter. Press **0** to turn the reminder off. Press **1** to set the reminder. Press **2** to reset the reminder.

Display Language *(on some models)*

The language for the scrolling display may be set at either English or Spanish.

Press **1** for English or **2** for Spanish.

Display On/Off

You can choose to turn the clock display on or off. Press **0** to turn the display off. Press **1** to turn the display on.

Display Speed

The scroll speed of the display can be changed. Select 1–5 for slowest to fastest scroll speed.

Other features your model may have.

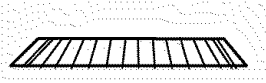

Shelf

Food microwaves best when placed on the turntable or on the shelf in the lower position.

Only use the shelf when reheating on more than one level. Do not store the shelf inside the oven cavity.

How to Use the Shelf When Microwaving

- Make sure the shelf is positioned properly inside the microwave to prevent damage to the oven from arcing.
- Do not use a microwave browning dish on the shelf. The shelf could overheat.
- Do not use the oven with the shelf on the microwave floor. This could damage the microwave.
- Use pot holders when handling the shelf—it may be hot.
- Do not use the shelf when cooking popcorn.
- Do not use the shelf with Sensor Cooking or **Reheat**.

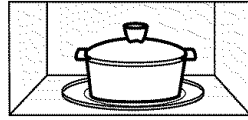

For best results

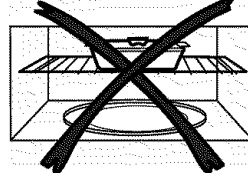

Uneven results

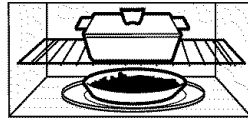
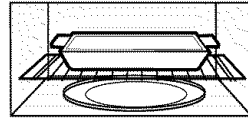

2-level reheating

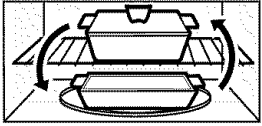

Switch places after 1/2 time

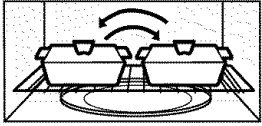

Switch places after 1/2 time

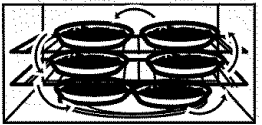

Switch places twice

Shelf and Reheating

To reheat on 2 levels

OR

To reheat 2 dishes on the lower level:

- 1 Multiply reheat time by 1½.
- 2 Switch places after 1/2 the time.

To reheat on 3 levels (on some models):

- 1 Turn the turntable off.
- 2 Double the reheating time.
- 3 Switch places twice and give the dishes a 1/2 turn during reheating. (Place dense foods, or those that require a longer cook time, on the upper shelf first.)

Microwave terms.

Term	Definition
Arcing	<p>Arcing is the microwave term for sparks in the oven. Arcing is caused by:</p> <ul style="list-style-type: none">■ the metal shelf being installed incorrectly and touching the microwave walls.■ metal or foil touching the side of the oven.■ foil that is not molded to food (upturned edges act like antennas).■ metal such as twist-ties, poultry pins, gold-rimmed dishes.■ recycled paper towels containing small metal pieces.
Covering	<p>Covers hold in moisture, allow for more even heating and reduce cooking time. Venting plastic wrap or covering with wax paper allows excess steam to escape.</p>
Shielding	<p>In a regular oven, you shield chicken breasts or baked foods to prevent over-browning. When microwaving, you use small strips of foil to shield thin parts, such as the tips of wings and legs on poultry, which would cook before larger parts.</p>
Standing Time	<p>When you cook with regular ovens, foods such as roasts or cakes are allowed to stand to finish cooking or to set. Standing time is especially important in microwave cooking. Note that a microwaved cake is not placed on a cooling rack.</p>
Venting	<p>After covering a dish with plastic wrap, you vent the plastic wrap by turning back one corner so excess steam can escape.</p>

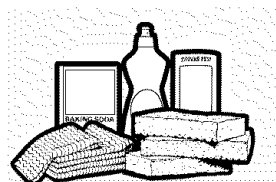

Helpful Hints

An occasional thorough wiping with a solution of baking soda and water keeps the inside fresh.

NOTE: Be certain the power is off before cleaning any part of this oven.

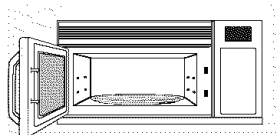

How to Clean the Inside

Walls, Floor, Inside Window, Metal and Plastic Parts on the Door

Some spatters can be removed with a paper towel; others may require a damp cloth. Remove greasy spatters with a sudsy cloth; then rinse with a damp cloth. Do not use abrasive cleaners or sharp utensils on oven walls.

Never use a commercial oven cleaner on any part of your microwave.

Removable Turntable and Turntable Support

To prevent breakage, do not place the turntable into water just after cooking. Wash it carefully in warm, sudsy water or in the dishwasher. The turntable and support can be broken if dropped. Remember, do not operate the oven without the turntable and support in place.

Shelf

Clean with mild soap and water or in the dishwasher.

Do not clean in a self-cleaning oven.

Temperature Probe (on some models)

Clean immediately after using. To clean, wipe with a sudsy cloth, then rub lightly with a plastic scouring ball if necessary. Rinse and dry. The probe can also be washed in the dishwasher.

Care and cleaning of the microwave oven.

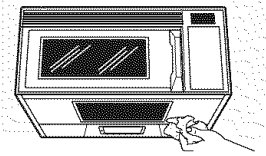

How to Clean the Outside

We recommend against using cleaners with ammonia or alcohol, as they can damage the appearance of the microwave oven. If you choose to use a common household cleaner, first apply the cleaner directly to a clean cloth, then wipe the soiled area.

Case

Clean the outside of the microwave with a sudsy cloth. Rinse and then dry. Wipe the window clean with a damp cloth.

Control Panel

Wipe with a damp cloth. Dry thoroughly. Do not use cleaning sprays, large amounts of soap and water, abrasives or sharp objects on the panel—they can damage it. Some paper towels can also scratch the control panel.

Door Panel

Before cleaning the front door panel, make sure you know what type of panel you have. Refer to the eighth digit of the model number: "S" is stainless steel, "G" is Graphite, "L" is CleanSteel and "B", "W" or "C" are plastic colors.

Stainless Steel

The stainless steel panel can be cleaned with Stainless Steel Magic or a similar product using a clean, soft cloth. Apply stainless cleaner carefully to avoid the surrounding plastic parts. Do not use appliance wax, polish, bleach or products containing chlorine on Stainless Steel finishes.

CleanSteel, Graphite

Use a clean, soft, light and lightly dampened cloth, then dry thoroughly. Do not use appliance wax, polish, bleach or products containing any chemical agent on the CleanSteel surfaces.

Plastic Color Panels

Use a clean, soft, lightly dampened cloth, then dry thoroughly.

Door Seal

It's important to keep the area clean where the door seals against the microwave. Use only mild, non-abrasive detergents applied with a clean sponge or soft cloth. Rinse well.

Bottom

Clean off the grease and dust on the bottom often. Use a solution of warm water and detergent.

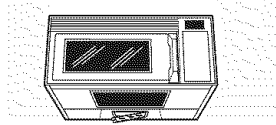
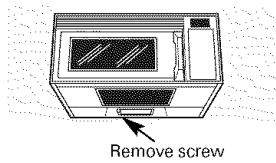

Cooktop Light/Night Light

On models JVM1850, JVM1851, EMO4000 and HDM1853, replace the burned-out bulb with a 120 volt, 40-watt incandescent bulb (WB36X10003), available from your GE supplier.

On models JVM1870, JVM1871, JVM3670 and JVM2050, replace the burned-out bulb with a 120 volt, 20-watt halogen bulb (WB36X10213), available from your GE supplier.

- 1 To replace the bulb(s), first disconnect the power at the main fuse or circuit breaker panel or pull the plug.
- 2 Remove the screw at the left edge of the light cover and push on the right edge of the cover to open.
- 3 Be sure the bulb(s) to be replaced are cool before removing. After breaking the adhesive seal, remove the bulb by either gently turning (for models JVM1850, JVM1851 and EMO4000) or pulling straight out (for models JVM1870, JVM1871, JVM2050 and JVM3670). Replace with the same size and type bulb.
- 4 Raise the light shield and replace the screw. Connect electrical power to the oven.

Replacing the light bulbs.

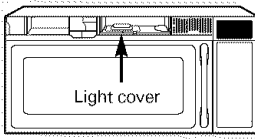
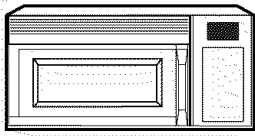

On some models

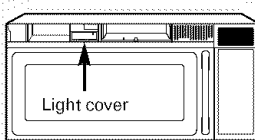

On some models

Oven Light

Replace the burned-out bulb with a 120 volt, 20-watt halogen bulb (WB36X10213), available from your GE supplier.

- 1 To replace the oven light, first disconnect the power at the main fuse or circuit breaker panel or pull the plug.
- 2 Remove the top grille by taking out the screws on top of the grille that hold it in place and sliding the grille to the left (opening the door makes grille removal easier).
- 3 Next, remove the light cover.

On some models, the light cover is located in the center of the top opening. Remove the screw that secures the light cover and lift the cover off.

On some models, the light cover is located at the left of the top opening. Lift the cover off.
- 4 Pinch the clips that hold the light socket in place and lift the socket out.
- 5 Remove the bulb from the light socket by pulling straight out. Replace with the same size and type bulb, then replace the light socket and cover.
- 6 Replace the grille and screws. Connect electrical power to the oven.

Charcoal Filter
(on some models)

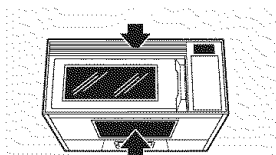

Reusable Grease Filter
(on all models)

The Vent Fan

The vent fan has a metal reusable grease filter.

Models that recirculate air back into the room also use a charcoal filter.

Reusable Grease Filter

The reusable grease filter traps grease released by foods on the cooktop. It also prevents flames from foods on the cooktop from damaging the inside of the microwave.

For this reason, the filter must ALWAYS be in place when the hood is used. The grease filter should be cleaned once a month, or as needed.

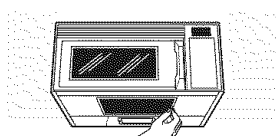

Removing and Cleaning the Filter

To remove, slide it to the side using the tab. Pull it down and out.

To clean the grease filter, soak it and then swish it around in hot water and detergent. Don't use ammonia or ammonia products because it will darken the metal. Light brushing can be used to remove embedded dirt.

Rinse, shake and let it dry before replacing.

To replace, slide the filter in the frame slot at the side of the opening. Pull up and in to lock into place.

About the exhaust feature.

Charcoal Filter (on some models)

The charcoal filter cannot be cleaned. It must be replaced.

For JVM1800 and JVM3600 Series models, order Part No. WB2X10733 from your GE supplier.

For JVM2000 Series models, order Part No. WB2X10956 from your GE supplier.

If the model is not vented to the outside, the air will be recirculated through a disposable charcoal filter that helps remove smoke and odors.

The charcoal filter should be replaced when it is noticeably dirty or discolored (usually after 6 to 12 months, depending on hood usage). See "Optional Kits", page 10, for more information.

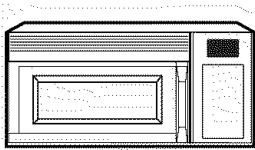

Remove grille screws to remove the grille.

To Remove Charcoal Filter

To remove the charcoal filter, disconnect power at the main fuse or circuit breaker panel or pull the plug.

Remove the top grille by removing the screws on top of the grille that hold it in place and sliding the grille to the left (opening the door makes grille removal easier). Slide the filter towards the front of the oven and remove it.

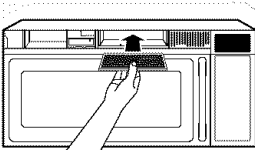

To Install Charcoal Filter

To install a new filter, remove plastic and other outer wrapping from the new filter.

Insert the filter into the top opening of the oven as shown. It will rest at an angle on 2 side support tabs and in front of the right rear tab. Replace the grille and screws.



Troubleshooting Tips

Save time and money! Review the charts on the following pages first and you may not need to call for service.

Problem	Possible Causes	What To Do
Oven will not start	A fuse in your home may be blown or the circuit breaker tripped.	* Replace fuse or reset circuit breaker.
	Power surge.	* Unplug the microwave oven; then plug it back in.
	Plug not fully inserted into wall outlet.	* Make sure the 3-prong plug on the oven is fully inserted into wall outlet.
	Door is not closed.	* Open and close the door securely.
Floor of the oven is warm, even when the oven has not been used	Heat from the cooktop light may make the oven floor get warm.	* This is normal.
"CONTROL LOCKED" or "LOCKED" appears on the display	The control has been locked.	* Press and hold CLEAR/OFF for about 3 seconds to unlock the control.
"SENSOR ERROR" appears on the display	When using a Sensor feature, the door was opened before steam could be detected.	* Do not open door until steam is sensed and time is shown counting down on the display.
	Steam was not detected in maximum amount of time.	* Use Time Cook to heat for more time.
You hear an unusual, low-tone beep	You have tried to start the Reminder without a valid time of day.	* Start over and enter a valid time of day.
	You have tried to start the Auto Nite Light without a valid time of day entered for the on-time and off-time.	* Start over and enter a valid time of day.
	You have tried to change the power level when it is not allowed.	* Many of the oven's features are preset and cannot be changed.
Food amount too large for Sensor Reheat	Sensor Reheat is for single servings of recommended foods.	* Use Time Cook for large amounts of food.

Before you call for service...

Things That Are Normal With Your Microwave Oven

- Moisture on the oven door and walls while cooking. Wipe the moisture off with a paper towel or soft cloth.
- Moisture between the oven door panels when cooking certain foods. Moisture should dissipate shortly after cooking is finished.
- Steam or vapor escaping from around the door.
- Light reflection around door or outer case.
- Dimming oven light and change in the blower sound at power levels other than high.
- Dull thumping sound while oven is operating.
- TV/radio interference might be noticed while using the microwave. Similar to the interference caused by other small appliances, it does not indicate a problem with the microwave. Plug the microwave into a different electrical circuit, move the radio or TV as far away from the microwave as possible, or check the position and signal of the TV/radio antenna.
- The Active Vent door (on some models) will open during operation, and remain open while the microwave is running, to keep the electronics cool. It is also normal to hear a clicking noise as the vent door opens and closes.

GE Service Protection Plus™

GE, a name recognized worldwide for quality and dependability, offers you Service Protection Plus™—comprehensive protection on all your appliances—**No Matter What Brand!**

Benefits Include:

- Backed by GE
- All brands covered
- Unlimited service calls
- All parts and labor costs included
- No out-of-pocket expenses
- No hidden deductibles
- One 800 number to call

***We'll Cover Any Appliance.
Anywhere. Anytime.****

You will be completely satisfied with our service protection or you may request your money back on the remaining value of your contract. No questions asked. It's that simple.

Protect your refrigerator, dishwasher, washer and dryer, range, TV, VCR and much more—**any brand!** Plus there's no extra charge for emergency service and low monthly financing is available. Even icemaker coverage and food spoilage protection is offered. You can rest easy, knowing that all your valuable household products are protected against expensive repairs.

Place your confidence in GE and call us in the U.S. toll-free at **800.626.2224** for more information.

*All brands covered, up to 20 years old, in the continental U.S.

 *Cut here*

Please place in envelope and mail to:

General Electric Company
Warranty Registration Department
P.O. Box 32150
Louisville, KY 40232-2150

Consumer Product Ownership Registration

Dear Customer:

Thank you for purchasing our product and thank you for placing your confidence in us. We are proud to have you as a customer!

Follow these three steps to protect your new appliance investment:

1 Complete and mail your Consumer Product Ownership Registration today. Have the peace of mind of knowing we can contact you in the unlikely event of a safety modification.

2 After mailing the registration below, store this document in a safe place. It contains information you will need should you require service. Our service number is 800.GE.CARES (800.432.2737).

3 Read your Owner's Manual carefully. It will help you operate your new appliance properly.

Model Number

Serial Number

_____	_____
-------	-------

Important: If you did not get a registration card with your product, detach and return the form below to ensure that your product is registered, or register online at ge.com.

✂ *Cut here*

Consumer Product Ownership Registration



Model Number

Serial Number

_____	_____
-------	-------

Mr. Ms. Mrs. Miss

First Name _____ Last Name _____

Street Address _____

Apt. # _____ E-mail Address* _____

City _____ State _____ Zip Code _____

Date Placed In Use
Month _____ Day _____ Year _____ Phone Number _____-_____-_____



GE Consumer & Industrial
Appliances
General Electric Company
Louisville, KY 40225
ge.com

* Please provide your e-mail address to receive, via e-mail, discounts, special offers and other important communications from GE Appliances (GEA).

Check here if you do not want to receive communications from GEA's carefully selected partners.

GE Microwave Oven Warranty.



All warranty service provided by our Factory Service Centers, or an authorized Customer Care® technician. To schedule service, on-line, 24 hours a day, visit us at ge.com, or call 800.GE.CARES (800.432.2737). Please have serial and model numbers available when calling for service.

Staple your receipt here. Proof of the original purchase date is needed to obtain service under the warranty.

For The Period Of: GE Will Replace:

For GE and GE Profile Models:

One Year
From the date of the original purchase

Any part of the microwave oven which fails due to a defect in materials or workmanship. During this **limited one-year warranty**, GE will also provide, **free of charge**, all labor and related service to replace the defective part.

For GE Profile Models ONLY:

Five Years
From the date of original purchase

The magnetron tube, if the magnetron tube fails due to a defect in materials or workmanship. During this **five-year limited warranty**, you will be responsible for any labor or in-home service costs.

What GE Will Not Cover:

- Service trips to your home to teach you how to use the product.
- Improper installation, delivery or maintenance.
- Product not accessible to provide required service.
- Failure of the product or damage to the product if it is abused, misused (for example, cavity arcing from wire rack or metal/foil), or used for other than the intended purpose or used commercially.
- Replacement of house fuses or resetting of circuit breakers.
- Damage to the product caused by accident, fire, floods or acts of God.
- Incidental or consequential damage caused by possible defects with this appliance.
- Damage caused after delivery.

EXCLUSION OF IMPLIED WARRANTIES—Your sole and exclusive remedy is product repair as provided in this Limited Warranty. Any implied warranties, including the implied warranties of merchantability or fitness for a particular purpose, are limited to one year or the shortest period allowed by law.

This warranty is extended to the original purchaser and any succeeding owner for products purchased for home use within the USA. If the product is located in an area where service by a GE Authorized Servicer is not available, you may be responsible for a trip charge or you may be required to bring the product to an Authorized GE Service Location for service. In Alaska, the warranty excludes the service calls to your home.

Some states do not allow the exclusion or limitation of incidental or consequential damages. This warranty gives you specific legal rights, and you may also have other rights which vary from state to state. To know what your legal rights are, consult your local or state consumer affairs office or your state's Attorney General.

Warrantor: General Electric Company, Louisville, KY 40225

Consumer Support.



GE Appliances Website

ge.com

Have a question or need assistance with your appliance? Try the GE Appliances Website 24 hours a day, any day of the year! For greater convenience and faster service, you can now download Owner's Manuals, order parts, catalogs, or even schedule service on-line. You can also "Ask Our Team of Experts"™ your questions, and so much more...

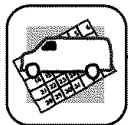

Schedule Service

ge.com

Expert GE repair service is only one step away from your door. Get on-line and schedule your service at your convenience 24 hours any day of the year! Or call 800.GE.CARES (800.432.2737) during normal business hours.



Real Life Design Studio

ge.com

GE supports the Universal Design concept—products, services and environments that can be used by people of all ages, sizes and capabilities. We recognize the need to design for a wide range of physical and mental abilities and impairments. For details of GE's Universal Design applications, including kitchen design ideas for people with disabilities, check out our Website today. For the hearing impaired, please call 800.TDD.GEAC (800.833.4322).



Extended Warranties

ge.com

Purchase a GE extended warranty and learn about special discounts that are available while your warranty is still in effect. You can purchase it on-line anytime, or call 800.626.2224 during normal business hours. GE Consumer Home Services will still be there after your warranty expires.

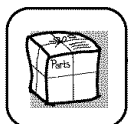

Parts and Accessories

ge.com

Individuals qualified to service their own appliances can have parts or accessories sent directly to their homes (VISA, MasterCard and Discover cards are accepted). Order on-line today, 24 hours every day or by phone at 800.626.2002 during normal business hours.

Instructions contained in this manual cover procedures to be performed by any user. Other servicing generally should be referred to qualified service personnel. Caution must be exercised, since improper servicing may cause unsafe operation.



Contact Us

ge.com

If you are not satisfied with the service you receive from GE, contact us on our Website with all the details including your phone number, or write to:

General Manager, Customer Relations
GE Appliances, Appliance Park
Louisville, KY 40225



Register Your Appliance

ge.com

Register your new appliance on-line—at your convenience! Timely product registration will allow for enhanced communication and prompt service under the terms of your warranty, should the need arise. You may also mail in the pre-printed registration card included in the packing material.

Printed in Malaysia