

This Owner's Manual is provided and hosted by [Appliance Factory Parts](#).



GE HDM1853WJ06 Owner's Manual

[Shop genuine replacement parts for GE HDM1853WJ06](#)



[Find Your GE Microwave Parts - Select From 3055 Models](#)

----- Manual continues below -----

Installation Instructions

Over the Range Microwave Oven

Questions? Call 800.GE.CARES (800.432.2737) or Visit our Website at: GEAppliances.com

BEFORE YOU BEGIN

Read these instructions completely and carefully.

- **IMPORTANT** – Save these instructions for local inspector's use.
- **IMPORTANT** – Observe all governing codes and ordinances.
- **Note to Installer** – Be sure to leave these instructions with the Consumer.
- **Note to Consumer** – Keep these instructions for future reference.
- **Skill level** – Installation of this appliance requires basic mechanical and electrical skills.
- Proper installation is the responsibility of the installer.
- Product failure due to improper installation is not covered under the Warranty.

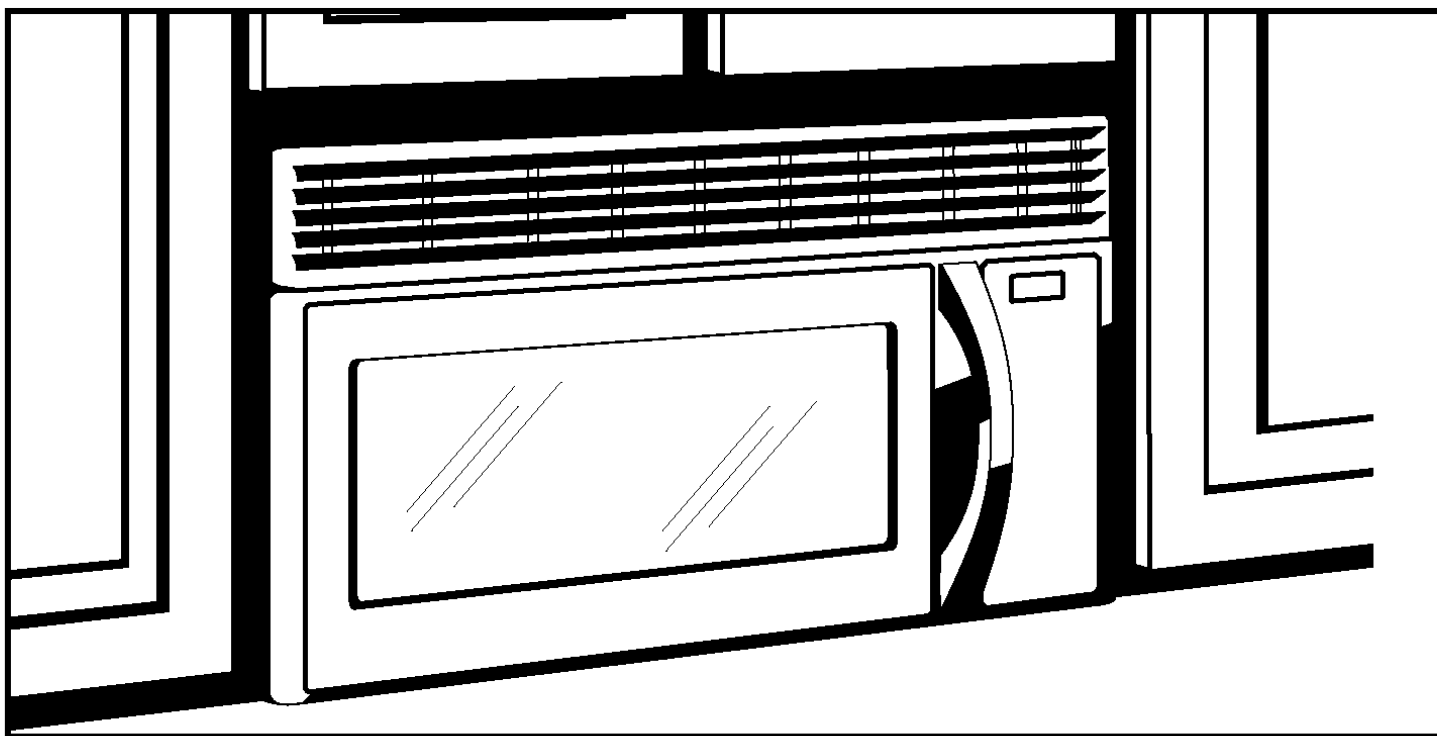

For a Spanish version of this manual, visit our Website at GEAppliances.com.

Para consultar una version en español de este manual de instrucciones, visite nuestro sitio de internet GEAppliances.com.

**READ CAREFULLY.
KEEP THESE INSTRUCTIONS.**

Installation Instructions

CONTENTS

General information

Important Safety Instructions	3
Electrical Requirements	3
Hood Exhaust	4, 5
Damage – Shipment/Installation.....	6
Parts Included.....	6
Tools You Will Need	7
Mounting Space	7

Step-by-step installation guide

Placement of Mounting Plate	8–10
Removing the Mounting Plate	8
Finding the Wall Studs.....	8
Determining Wall Plate Location	9
Aligning the Wall Plate.....	10

Installation Types..... 11–22

A Outside Top Exhaust	12–14
Attach Mounting Plate to Wall	12
Preparation of Top Cabinet	13
Checking for Proper Damper Operation.....	13
Mount the Microwave Oven	13
Adjust the Exhaust Adaptor	14
Connecting Ductwork.....	14
B Outside Back Exhaust.....	15–18
Preparing Rear Wall for Outside Back Exhaust.....	15
Remove Exhaust Adaptor	15
Attach Mounting Plate to Wall	16
Preparation of Top Cabinet	16
Adapting Microwave Blower for Outside Back Exhaust.....	16, 17
Mount the Microwave Oven	18

C Recirculating	19–22
Attach Mounting Plate to Wall	19
Preparation of Top Cabinet	19
Check Microwave Assembly	20
Adapting Microwave Blower for Recirculation	20, 21
Mount the Microwave Oven	21, 22
Installing the Charcoal Filter	22
Before You Use Your Microwave	23

Installation Instructions

IMPORTANT SAFETY INSTRUCTIONS

This product requires a three-prong grounded outlet. The installer must perform a ground continuity check on the power outlet box before beginning the installation to insure that the outlet box is properly grounded. If not properly grounded, or if the outlet box does not meet electrical requirements noted (under ELECTRICAL REQUIREMENTS), a qualified electrician should be employed to correct any deficiencies.



CAUTION: For personal safety, remove house fuse or open circuit breaker before beginning installation to avoid severe or fatal shock injury.

CAUTION: For personal safety, the mounting surface must be capable of supporting the cabinet load, in addition to the added weight of this 63–85 pound product, plus additional oven loads of up to 50 pounds or a total weight of 113–135 pounds.

CAUTION: For personal safety, this product cannot be installed in cabinet arrangements such as an island or a peninsula. It must be mounted to **BOTH** a top cabinet **AND** a wall.

NOTE: For easier installation and personal safety, it is recommended that two people install this product.

IMPORTANT – PLEASE READ CAREFULLY. FOR PERSONAL SAFETY, THIS APPLIANCE MUST BE PROPERLY GROUNDED TO AVOID SEVERE OR FATAL SHOCK.

The power cord of this appliance is equipped with a three-prong (grounding) plug which mates with a standard three-prong (grounding) wall receptacle to minimize the possibility of electric shock hazard from this appliance.



Ensure proper ground exists before use

You should have the wall receptacle and circuit checked by a qualified electrician to make sure the receptacle is properly grounded.

Where a standard two-prong wall receptacle is encountered, it is very important to have it replaced with a properly grounded three-prong wall receptacle, installed by a qualified electrician.

DO NOT, UNDER ANY CIRCUMSTANCES, CUT, DEFORM OR REMOVE ANY OF THE PRONGS FROM THE POWER CORD. DO NOT USE WITH AN EXTENSION CORD.

ELECTRICAL REQUIREMENTS

Product rating is 120 volts AC, 60 Hertz, 15 amps and 1.58 kilowatts. This product must be connected to a supply circuit of the proper voltage and frequency. Wire size must conform to the requirements of the National Electrical Code or the prevailing local code for this kilowatt rating. The power supply cord and plug should be brought to a separate 15- to 20- ampere branch circuit single grounded outlet. The outlet box should be located in the cabinet above the microwave oven. The outlet box and supply circuit should be installed by a qualified electrician and conform to the National Electrical Code or the prevailing local code.

Installation Instructions

HOOD EXHAUST

NOTE: Read these next two pages only if you plan to vent your exhaust to the outside. If you plan to recirculate the air back into the room, proceed to page 6.

OUTSIDE TOP EXHAUST (EXAMPLE ONLY)

The following chart describes an example of one possible ductwork installation.



DUCT PIECES		EQUIVALENT LENGTH	x	NUMBER USED	=	EQUIVALENT LENGTH	
	Roof Cap	24 Ft.	x	(1)	=	24 Ft.	
	12 Ft. Straight Duct (6" Round)	12 Ft.	x	(1)	=	12 Ft.	
	Rectangular-to-Round Transition Adaptor*	5 Ft.	x	(1)	=	5 Ft.	
Equivalent lengths of duct pieces are based on actual tests and reflect requirements for good venting performance with any vent hood.						Total Length =	41 Ft.

* **IMPORTANT:** If a rectangular-to-round transition adaptor is used, the bottom corners of the damper will have to be cut to fit, using the tin snips, in order to allow free movement of the damper.

OUTSIDE BACK EXHAUST (EXAMPLE ONLY)

The following chart describes an example of one possible ductwork installation.



DUCT PIECES		EQUIVALENT LENGTH*	x	NUMBER USED	=	EQUIVALENT LENGTH	
	Wall Cap	40 Ft.	x	(1)	=	40 Ft.	
	3 Ft. Straight Duct (3 1/4" x 10" Rectangular)	3 Ft.	x	(1)	=	3 Ft.	
	90° Elbow	10 Ft.	x	(2)	=	20 Ft.	
Equivalent lengths of duct pieces are based on actual tests and reflect requirements for good venting performance with any vent hood.						Total Length =	63 Ft.

NOTE: For back exhaust, care should be taken to align exhaust with space between studs, or wall should be prepared at the time it is constructed by leaving enough space between the wall studs to accommodate exhaust.

Installation Instructions

NOTE: If you need to install ducts, note that the total duct length of 3¼" x 10" rectangular or 6" diameter round duct **should not exceed 140 equivalent feet**. Outside ventilation requires a HOOD EXHAUST DUCT. Read the following carefully.

NOTE: It is important that venting be installed using the most direct route and with as few elbows as possible. This ensures clear venting of exhaust and helps prevent blockages. **Also, make sure dampers swing freely and nothing is blocking the ducts.**

Exhaust connection:







The hood exhaust has been designed to mate with a standard 3¼" x 10" rectangular duct.

If a round duct is required, a rectangular-to-round transition adaptor must be used. **Do not use less than a 6" diameter duct.**

Maximum duct length:

For satisfactory air movement, the total duct length of 3¼" x 10" rectangular or 6" diameter round duct **should not exceed 140 equivalent feet**.

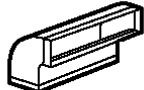
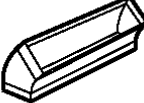
Elbows, transitions, wall and roof caps, etc., present additional resistance to airflow and are equivalent to a section of straight duct which is longer than their actual physical size. When calculating the total duct length, add the equivalent lengths of all transitions and adaptors plus the length of all straight duct sections. The chart below shows you how to calculate total equivalent ductwork length using the approximate feet of equivalent length of some typical ducts.

DUCT PIECES	EQUIVALENT LENGTH	x	NUMBER USED	=	EQUIVALENT LENGTH
 Rectangular-to-Round Transition Adaptor*	5 Ft.	x	()	=	Ft.
 Wall Cap	40 Ft.	x	()	=	Ft.
 90° Elbow	10 Ft.	x	()	=	Ft.
 45° Elbow	5 Ft.	x	()	=	Ft.
 90° Elbow	25 Ft.	x	()	=	Ft.
 45° Elbow	5 Ft.	x	()	=	Ft.
 Roof Cap	24 Ft.	x	()	=	Ft.
 Straight Duct 6" Round or 3¼" x 10" Rectangular	1 Ft.	x	()	=	Ft.
Total Ductwork				=	Ft.



*** IMPORTANT:** If a rectangular-to-round transition adaptor is used, the bottom corners of the damper will have to be cut to fit, using the tin snips, in order to allow free movement of the damper.

Equivalent lengths of duct pieces are based on actual tests and reflect requirements for good venting performance with any vent hood.

Installation Instructions

DAMAGE – SHIPMENT/ INSTALLATION

- If the unit is damaged in shipment, return the unit to the store in which it was bought for repair or replacement.
- If the unit is damaged by the customer, repair or replacement is the responsibility of the customer.
- If the unit is damaged by the installer (if other than the customer), repair or replacement must be made by arrangement between customer and installer.

PARTS INCLUDED

HARDWARE PACKET

PART		QUANTITY
	Wood Screws ($\frac{1}{4}$ " x 2")	2
	Toggle Bolts (and wing nuts) ($\frac{3}{16}$ " x 3")	4
	Self-Aligning Machine Screws ($\frac{1}{4}$ "-28 x $\frac{3}{4}$ ")	3
	Nylon Grommet (for metal cabinets)	2

You will find the installation hardware contained in a packet with the unit. Check to make sure you have all these parts.

NOTE: Some extra parts are included.

ADDITIONAL PARTS

PART		QUANTITY
	Top Cabinet Template	1
	Rear Wall Template	1
	Installation Instructions	1
	Separately Packed Grease Filters	2

Installation Instructions

TOOLS YOU WILL NEED

 # 1 and #2 Phillips screwdriver

 Pencil

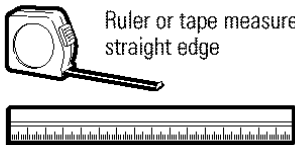
 Ruler or tape measure and straight edge

 Carpenter square (optional)

 Tin snips (for cutting damper, if required)

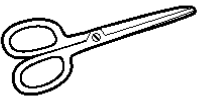
 Scissors (to cut template, if necessary)

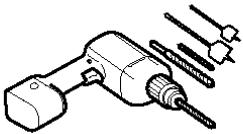
 Electric drill with $\frac{3}{16}$ " , $\frac{1}{2}$ " and $\frac{5}{8}$ " drill bits

 Filler blocks or scrap wood pieces, if needed for top cabinet spacing (used on recessed bottom cabinet installations only)

 Gloves

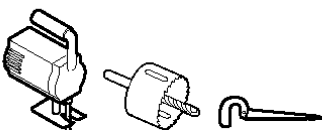
 Saw (saber, hole or keyhole)

 Stud finder or Hammer (optional)

 Safety goggles

 Level

 Duct and masking tape

MOUNTING SPACE



NOTES:

- The space between the cabinets must be 30" wide and free of obstructions.
- If the space between the cabinets is greater than 30", a Filler Panel Kit may be used to fill in the gap between the microwave oven and the cabinets. Your Owner's Manual contains the kit number for your model.
- This microwave oven is for installation over ranges up to 36" wide.
- If you are going to vent your microwave oven to the outside, see Hood Exhaust Section for exhaust duct preparation.
- When installing the microwave oven beneath smooth, flat cabinets, be careful to follow the instructions on the top cabinet template for power cord clearance.

Installation Instructions

1 PLACEMENT OF THE MOUNTING PLATE

A. REMOVING THE MICROWAVE OVEN FROM THE CARTON/ REMOVING THE MOUNTING PLATE

- 1 Remove the installation instructions, filters, glass tray and the small hardware bag. Do not remove the Styrofoam protecting the front of the oven.
- 2 Fold back all 4 carton flaps fully against carton sides. Then carefully roll the oven and carton over onto the top side. The oven should be resting in the Styrofoam.

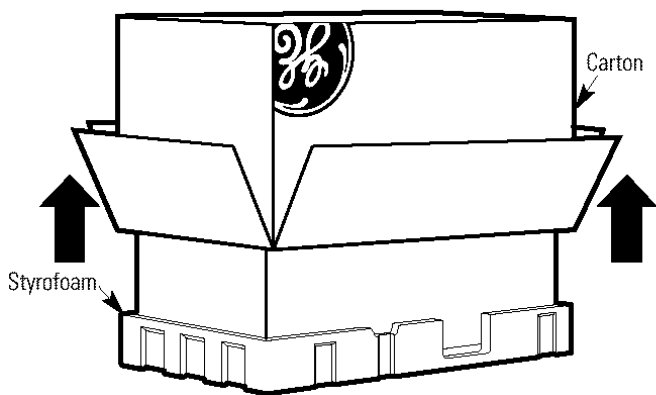

- 3 Pull the carton up and off the oven.
- 4 Remove and properly discard plastic bags.



- 5 Remove the 2 screws from the mounting plate. This plate will be used as the rear wall template and for mounting. You may discard these screws.

B. FINDING THE WALL STUDS



- 1 Find the studs, using one of the following methods:
 - A. Stud finder – a magnetic device which locates nails.

OR

 - B. Use a hammer to tap lightly across the mounting surface to find a solid sound. This will indicate a stud location.
- 2 After locating the stud(s), find the center by probing the wall with a small nail to find the edges of the stud. Then place a mark halfway between the edges. The center of any adjacent studs should be 16" or 24" from this mark.
- 3 Draw a line down the center of the studs.

THE MICROWAVE MUST BE CONNECTED TO AT LEAST ONE WALL STUD.

Installation Instructions

C. DETERMINING WALL PLATE LOCATION UNDER YOUR CABINET

Plate position – beneath flat bottom cabinet



Plate position – beneath framed recessed cabinet bottom



Plate position – beneath recessed bottom cabinet with front overhang



Your cabinets may have decorative trim that interferes with the microwave installation. Remove the decorative trim to install the microwave properly and to make it level.

THE MICROWAVE MUST BE LEVEL.

Use a level to make sure the cabinet bottom is level.

If the cabinets have a front overhang only, with no back or side frame, install the mounting plate down the same distance as the front overhang depth. This will keep the microwave level.

- 1 Measure the inside depth of the front overhang.
- 2 Draw a horizontal line on the back wall an equal distance below the cabinet bottom as the inside depth of the front overhang.
- 3 For this type of installation with front overhang only, align the mounting tabs with this horizontal line, not touching the cabinet bottom as described in Step D.

Installation Instructions

D. ALIGNING THE WALL PLATE



CAUTION: Wear gloves to avoid cutting fingers on sharp edges.

- 1** Draw a vertical line on the wall at the center of the 30" wide space.
- 2** Use the mounting plate **as the template** for the rear wall. Place the mounting plate on the wall, making sure that the tabs are **touching the bottom of the cabinet or the level line drawn in Step C for cabinets with front overhang. Line up the notch and centerline on the bottom of the mounting plate to the centerline on the wall.**
- 3** While holding the mounting plate with one hand, draw circles on the wall at holes A, B, C and D (see illustration above/actual plate marked with arrows). **Four holes must be used for mounting.**

NOTE: Holes C and D are inside area E. If neither C nor D is in a stud, find a stud somewhere in area E and draw a fifth circle to line up with the stud. It is important to use **at least one wood screw mounted firmly in a stud** to support the weight of the microwave. **Set the mounting plate aside.**

- 4** Drill holes on the circles. If there is a stud, drill a $\frac{3}{16}$ " hole for wood screws. For holes that don't line up with a stud, drill a $\frac{5}{8}$ " hole for toggle bolts.

NOTE: DO NOT MOUNT THE PLATE AT THIS TIME.

Installation Instructions

2 INSTALLATION TYPES (Choose A, B or C)

This microwave oven is designed for adaptation to the following three types of ventilation:

- A. Outside Top Exhaust (Vertical Duct)
- B. Outside Back Exhaust (Horizontal Duct)
- C. Recirculating (Non-Vented Ductless)

NOTE: This microwave is shipped assembled for Outside Top Exhaust (except for non-vented models). Select the type of ventilation required for your installation and proceed to that section.

A OUTSIDE TOP EXHAUST (VERTICAL DUCT)



B OUTSIDE BACK EXHAUST (HORIZONTAL DUCT)



C RECIRCULATING (NON-VENTED DUCTLESS)



A Charcoal Filter Accessory Kit is required for the non-vented exhaust. (See your Owner's Manual for the kit number.)

Installation Instructions

A OUTSIDE TOP EXHAUST (Vertical Duct)

INSTALLATION OVERVIEW

- A1. Attach Mounting Plate to Wall
- A2. Prepare Top Cabinet
- A3. Check Damper Operation
- A4. Mount Microwave Oven
- A5. Adjust Exhaust Adaptor
- A6. Connect Ductwork



A1. ATTACH THE MOUNTING PLATE TO THE WALL



Attach the plate to the wall using toggle bolts. At least one wood screw must be used to attach the plate to a wall stud.

- 1 Remove the toggle wings from the bolts.
- 2 Insert the bolts into the mounting plate through the holes designated to go into drywall and reattach the toggle wings to $\frac{3}{4}$ " onto each bolt.

To use toggle bolts:



- 3 Place the mounting plate against the wall and insert the toggle wings into the holes in the wall to mount the plate.

NOTE: Before tightening toggle bolts and wood screw, make sure the tabs on the mounting plate touch the bottom of the cabinet when pushed flush against the wall and that the plate is properly centered under the cabinet.

CAUTION: Be careful to avoid pinching fingers between the back of the mounting plate and the wall.

- 4 Tighten all bolts. Pull the plate away from the wall to help tighten the bolts.

Installation Instructions

A2. USE TOP CABINET TEMPLATE FOR PREPARATION OF TOP CABINET

You need to drill holes for the top support screws, a hole large enough for the power cord to fit through, and a cutout large enough for the exhaust adaptor.



- Read the instructions on the TOP CABINET TEMPLATE.
- Tape it underneath the top cabinet.
- Drill the holes, following the instructions on the TOP CABINET TEMPLATE.

CAUTION: Wear safety goggles when drilling holes in the cabinet bottom.

A3. CHECK FOR PROPER DAMPER OPERATION



- Place the microwave in its upright position, with the top of the unit facing up.
- This microwave oven may be shipped assembled for top exhaust (adaptor installed) or for recirculation exhaust (adaptor absent).
- **Make sure tape securing damper is removed and damper pivots easily before mounting microwave.**
- You will need to make adjustments to assure proper alignment with your house exhaust duct after the microwave is installed.

A4. MOUNT THE MICROWAVE OVEN



FOR EASIER INSTALLATION AND PERSONAL SAFETY, WE RECOMMEND THAT TWO PEOPLE INSTALL THIS MICROWAVE OVEN.

IMPORTANT: Do not grip or use handle during installation.

NOTE: If your cabinet is metal, use the nylon grommet around the power cord hole to prevent cutting of the cord.

NOTE: We recommend using filler blocks if the cabinet front hangs below the cabinet bottom shelf.

IMPORTANT: If filler blocks are not used, case damage may occur from overtightening screws.

NOTE: When mounting the microwave oven, thread power cord through hole in bottom of top cabinet. Keep it tight throughout Steps 1-3. Do not pinch cord or lift oven by pulling cord.

- 1 Lift microwave, tilt it forward, and hook slots at back bottom edge onto four lower tabs of mounting plate.



- 2 Rotate front of oven up against cabinet bottom.

- 3 Insert a self-aligning screw through top center cabinet hole. Temporarily secure the oven by turning the screw at least two full turns after the threads have engaged. (It will be completely tightened later.) **Be sure to keep power cord tight. Be careful not to pinch the cord, especially when mounting flush to bottom of cabinet.**

Installation Instructions

A4. MOUNT THE MICROWAVE OVEN (cont.)



4 Attach the microwave oven to the top cabinet.

5 Insert 2 self-aligning screws through outer top cabinet holes. Turn two full turns on each screw.



7 Tighten the outer two screws to the top of the microwave oven. (While tightening screws, hold the microwave oven in place against the wall and the top cabinet.)

1400 and 1600 Series

1800 Series

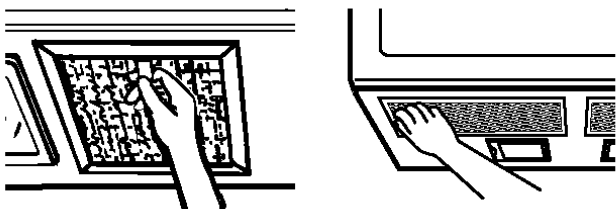

8 Install grease filters. See the Owner's Manual packed with the microwave.

A5. ADJUST THE EXHAUST ADAPTOR

Open the top cabinet and adjust the exhaust adaptor to connect to the house duct.

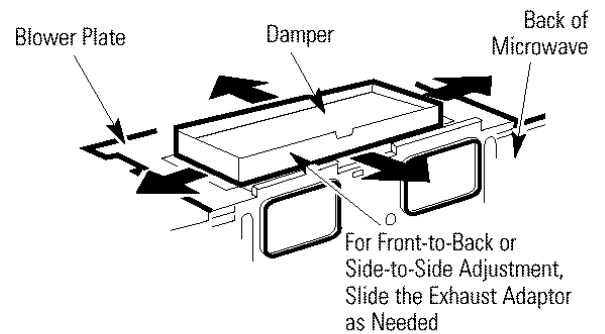

A6. CONNECTING DUCTWORK



1 Extend the house duct down to connect to the exhaust adaptor.

2 Seal exhaust duct joints using duct tape.

Installation Instructions

B OUTSIDE BACK EXHAUST (Horizontal Duct)

INSTALLATION OVERVIEW

- B1. Prepare Rear Wall
- B2. Remove Exhaust Adaptor
- B3. Attach Mounting Plate to Wall
- B4. Prepare Top Cabinet
- B5. Adjust Blower
- B6. Mount the Microwave Oven



B1. PREPARING THE REAR WALL FOR OUTSIDE BACK EXHAUST

You need to cut an opening in the rear wall for outside exhaust.



- Read the instructions on the REAR WALL TEMPLATE.
- Tape it to the rear wall, lining up with the holes previously drilled for holes A and B in the wall plate.
- Cut the opening, following the instructions of the REAR WALL TEMPLATE.

B2. REMOVE EXHAUST ADAPTOR

This microwave oven is shipped assembled for top exhaust. You will need the exhaust adaptor for installation in the rear wall opening. To remove the exhaust adaptor from the microwave oven:

- 1 Remove tape securing damper.
- 2 Remove and save screw that holds blower plate to microwave.
- 3 Lift off the blower plate and attached adaptor from the microwave.
- 4 Slide exhaust adaptor to one side and remove it.



Installation Instructions

B3. ATTACH THE MOUNTING PLATE TO THE WALL



Attach the plate to the wall using toggle bolts. At least one wood screw must be used to attach the plate to a wall stud.

- 1 Remove the toggle wings from the bolts.
- 2 Insert the bolts into the mounting plate through the holes designated to go into drywall and reattach the toggle wings to $\frac{3}{4}$ " onto each bolt.

To use toggle bolts:



- 3 Place the mounting plate against the wall and insert the toggle wings into the holes in the wall to mount the plate.

NOTE: Before tightening toggle bolts and wood screw, make sure the tabs on the mounting plate touch the bottom of the cabinet when pushed flush against the wall and that the plate is properly centered under the cabinet.

CAUTION: Be careful to avoid pinching fingers between the back of the mounting plate and the wall.

- 4 Tighten all bolts. Pull the plate away from the wall to help tighten the bolts.

B4. USE TOP CABINET TEMPLATE FOR PREPARATION OF TOP CABINET

You need to drill holes for the top support screws and a hole large enough for the power cord to fit through.



- Read the instructions on the TOP CABINET TEMPLATE.
- Tape it underneath the top cabinet.
- Drill the holes, following the instructions on the TOP CABINET TEMPLATE.

CAUTION: Wear safety goggles when drilling holes in the cabinet bottom.

B5. ADAPTING MICROWAVE BLOWER FOR OUTSIDE BACK EXHAUST

- 1 Remove and save screw that holds blower motor to microwave.



- 2 Carefully pull out the blower unit. The wires will extend far enough to allow you to adjust the blower unit.



Installation Instructions

B5. ADAPTING MICROWAVE BLOWER FOR OUTSIDE BACK EXHAUST (cont.)

- 3** Rotate blower unit counterclockwise 180°.

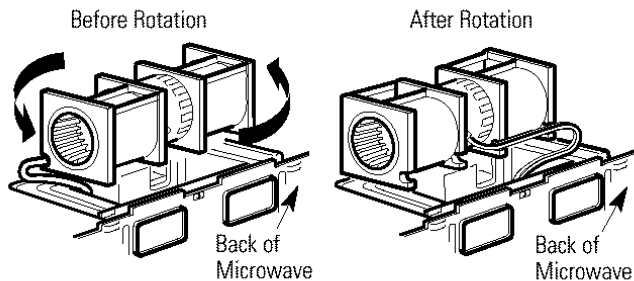

- 4** Gently remove the wires from the grooves. Reroute the wires through grooves on other side of the blower unit.

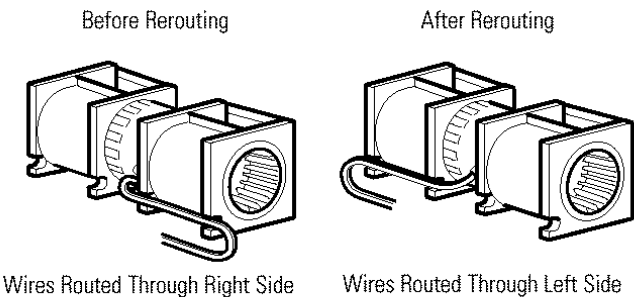

- 5** Roll the blower unit 90° so that fan blade openings are facing out the back of the microwave.

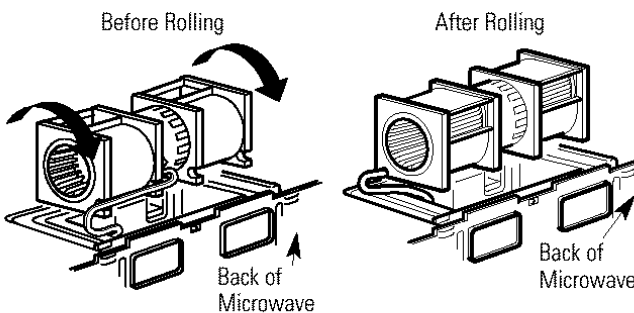

- 6** Place the blower unit back into the opening.

AFTER: Fan Blade Openings Facing Back



CAUTION: Do not pull or stretch the blower unit wiring. Make sure the wires are not pinched.

NOTE: The blower unit exhaust openings should match exhaust openings on rear of microwave oven.

- 7** Secure the blower unit to the microwave with the screw from Step 1.



- 8** Replace the blower plate in the same position as before with the screw.

- 9** Attach the exhaust adaptor to the rear of the oven by sliding it into the guides at the top center of the back of the oven.



Push in securely until it is in the lower locking tabs. Take care to assure that the damper hinge is installed so that it is at the top and that the damper swings freely.

Installation Instructions

B6. MOUNT THE MICROWAVE OVEN



FOR EASIER INSTALLATION AND PERSONAL SAFETY, WE RECOMMEND THAT TWO PEOPLE INSTALL THIS MICROWAVE OVEN.

IMPORTANT: Do not grip or use handle during installation.

NOTE: If your cabinet is metal, use the nylon grommet around the power cord hole to prevent cutting of the cord.

NOTE: We recommend using filler blocks if the cabinet front hangs below the cabinet bottom shelf.

IMPORTANT: If filler blocks are not used, case damage may occur from overtightening screws.

NOTE: When mounting the microwave oven, thread power cord through hole in bottom of top cabinet. Keep it tight throughout Steps 1-3. Do not pinch cord or lift oven by pulling cord.

1 Lift microwave, tilt it forward, and hook slots at back bottom edge onto four lower tabs of mounting plate.



2 Rotate front of oven up against cabinet bottom.

3 Insert a self-aligning screw through top center cabinet hole. Temporarily secure the oven by turning the screw at least **two full turns** after the threads have engaged. (It will be completely tightened later.) **Be sure to keep power cord tight. Be careful not to pinch the cord, especially when mounting flush to bottom of cabinet.**



4 Attach the microwave oven to the top cabinet.

5 Insert 2 self-aligning screws through outer top cabinet holes. Turn two full turns on each screw.



6 Tighten center screw completely.

7 Tighten the outer two screws to the top of the microwave oven. (While tightening screws, hold the microwave oven in place against the wall and the top cabinet.)

1400 and 1600 Series

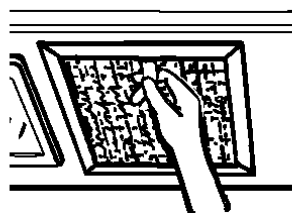

1800 Series

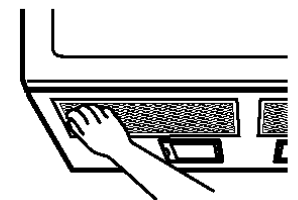

8 Install grease filters. See the Owner's Manual packed with the microwave.

Installation Instructions

C RECIRCULATING (Non-Vented Ductless)

INSTALLATION OVERVIEW

- C1. Attach Mounting Plate to Wall
- C2. Prepare Top Cabinet
- C3. Check Microwave Assembly
- C4. Adjust Blower
- C5. Mount the Microwave Oven
- C6. Install Charcoal Filter



C1. ATTACH THE MOUNTING PLATE TO THE WALL



Attach the plate to the wall using toggle bolts. At least one wood screw must be used to attach the plate to a wall stud.

- 1 Remove the toggle wings from the bolts.
- 2 Insert the bolts into the mounting plate through the holes designated to go into drywall and reattach the toggle wings to $\frac{3}{4}$ " onto each bolt.

To use toggle bolts:

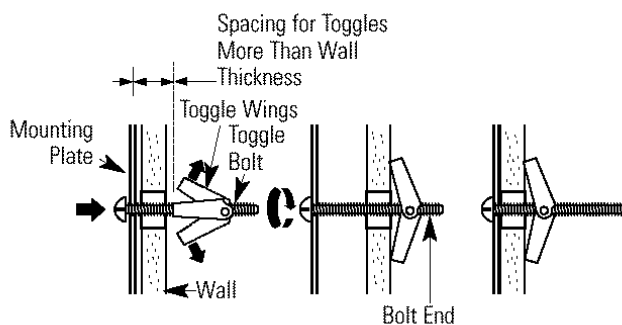

- 3 Place the mounting plate against the wall and insert the toggle wings into the holes in the wall to mount the plate.

NOTE: Before tightening toggle bolts and wood screw, make sure the tabs on the mounting plate touch the bottom of the cabinet when pushed flush against the wall and that the plate is properly centered under the cabinet.

CAUTION: Be careful to avoid pinching fingers between the back of the mounting plate and the wall.

- 4 Tighten all bolts. Pull the plate away from the wall to help tighten the bolts.

C2. USE TOP CABINET TEMPLATE FOR PREPARATION OF TOP CABINET

You need to drill holes for the top support screws and a hole large enough for the power cord to fit through.



- Read the instructions on the TOP CABINET TEMPLATE.
- Tape it underneath the top cabinet.
- Drill the holes, following the instructions on the TOP CABINET TEMPLATE.

CAUTION: Wear safety goggles when drilling holes in the cabinet bottom.

Installation Instructions

C3. CHECK MICROWAVE ASSEMBLY

Exhaust Adaptor (absent on models shipped for recirculation exhaust)



- Place the microwave in its upright position, with the top of the unit facing up.
- The microwave oven may be shipped assembled for top exhaust (adaptor installed) or for recirculation exhaust (adaptor absent).
- If the microwave was shipped for recirculation exhaust, skip to C5. If shipped for top exhaust, proceed with C4.

C4. ADAPTING MICROWAVE BLOWER FOR RECIRCULATION

- 1** Remove and save screw that holds blower plate to microwave.
- 2** Lift off the blower plate and attached adaptor from the microwave.



- 3** Slide exhaust adaptor to one side and remove it.
- NOTE:** The exhaust adaptor with damper is not needed for recirculating models. You may want to save them for possible future use.



- 4** Remove and save the screw that holds the blower motor to the microwave.

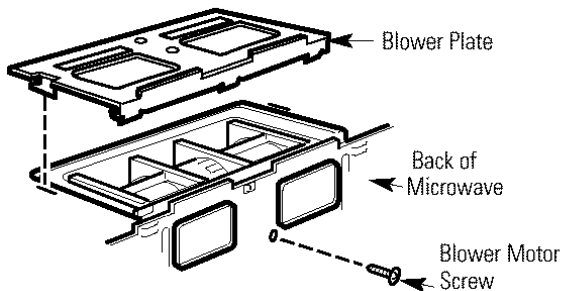

- 5** Carefully pull out the blower unit. The wires will extend far enough to allow you to adjust the blower unit.



- 6** Roll the blower unit 90° so that fan blade openings are facing toward the front of the microwave.

BEFORE: Fan Blade Openings Facing Up

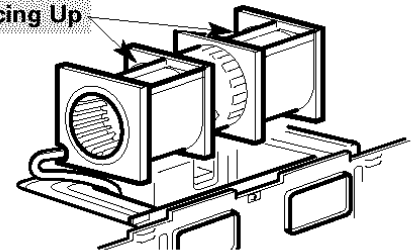

Roll



AFTER: Fan Blade Openings Facing Forward

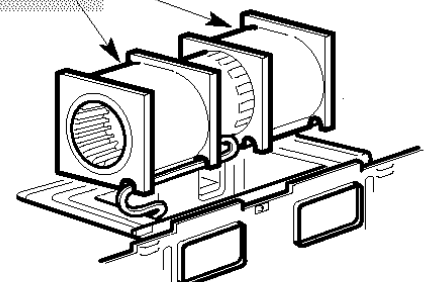

NOTE: Make sure wires remain routed in the grooves of the motor frame.

Installation Instructions

C4. ADAPTING MICROWAVE BLOWER FOR RECIRCULATION (cont.)

- 7 Place the blower unit back into the opening.
CAUTION: Do not pull or stretch the blower unit wiring. Make sure the wires are not pinched.



- 8 Secure blower unit to microwave with the screw removed in Step 4.
9 Replace blower plate with the screw removed in Step 1.

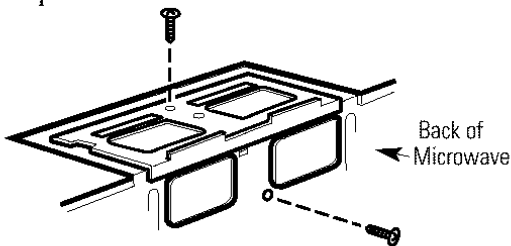

C5. MOUNT THE MICROWAVE OVEN



FOR EASIER INSTALLATION AND PERSONAL SAFETY, WE RECOMMEND THAT TWO PEOPLE INSTALL THIS MICROWAVE OVEN.

IMPORTANT: Do not grip or use handle during installation.

NOTE: If your cabinet is metal, use the nylon grommet around the power cord hole to prevent cutting of the cord.

NOTE: We recommend using filler blocks if the cabinet front hangs below the cabinet bottom shelf.

IMPORTANT: If filler blocks are not used, case damage may occur from overtightening screws.

NOTE: When mounting the microwave oven, thread power cord through hole in bottom of top cabinet. Keep it tight throughout Steps 1-3. Do not pinch cord or lift oven by pulling cord.

- 1 Lift microwave, tilt it forward, and hook slots at back bottom edge onto four lower tabs of mounting plate.



- 2 Rotate front of oven up against cabinet bottom.

- 3 Insert a self-aligning screw through top center cabinet hole. Temporarily secure the oven by turning the screw at least **two full turns** after the threads have engaged. (It will be completely tightened later.) **Be sure to keep power cord tight. Be careful not to pinch the cord, especially when mounting flush to bottom of cabinet.**

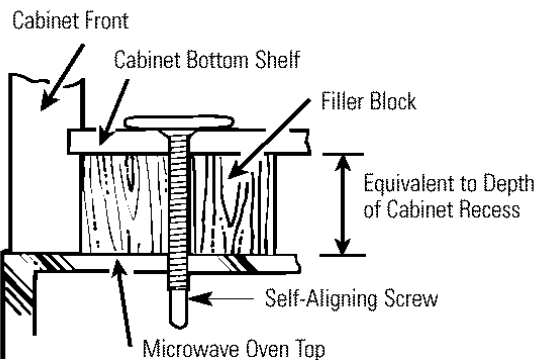

- 4 Attach the microwave oven to the top cabinet.

Installation Instructions

C5. MOUNT THE MICROWAVE OVEN (cont.)

- 5** Insert 2 self-aligning screws through outer top cabinet holes. Turn two full turns on each screw.



- 7** Tighten the outer two screws to the top of the microwave oven. (While tightening screws, hold the microwave oven in place against the wall and the top cabinet.)

1400 and 1600 Series

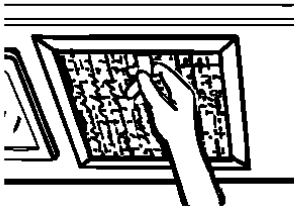

1800 Series



- 8** Install grease filters. See the Owner's Manual packed with the microwave.

C6. INSTALLING THE CHARCOAL FILTER

- 1** On 1400 and 1600 Series models, remove screws on front of grille using a #1 Phillips screwdriver. On 1800 Series models, remove screws on top front of grille using a #2 Phillips screwdriver.

- 2** Open the door.

- 3** Remove the grille.

On 1400 and 1600 Series models, pull the grille straight off.

On 1800 Series models, slide the grille to the left and pull it straight off.

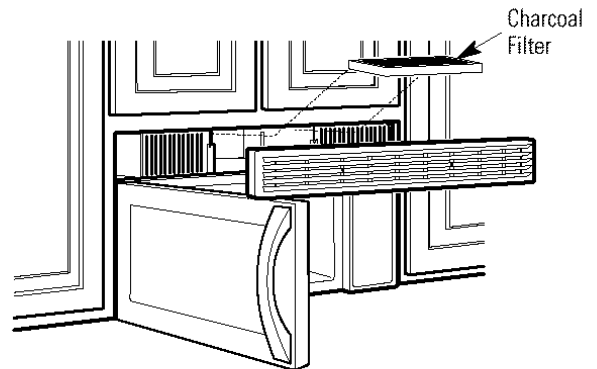

- 4** Install the charcoal filter. When properly installed, the wire mesh of the filter should be visible from the front.

- 5** Replace the grille and the screws.

- 6** Close the door.

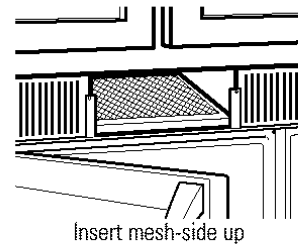

Installation Instructions

BEFORE YOU USE YOUR MICROWAVE

1. Make sure the microwave oven has been installed according to instructions.



6. Read the Owner's Manual.



2. Remove all packing material from the microwave oven.

3. Install turntable and ring in cavity.

4. Replace house fuse or turn breaker back on.



7. KEEP INSTALLATION INSTRUCTIONS FOR THE LOCAL INSPECTOR'S USE.



5. Plug power cord into a dedicated 15- to 20-amp electrical outlet.



I64D3370P208
49-40247

01-02 JR

Printed in Korea