

This Owner's Manual is provided and hosted by [Appliance Factory Parts](#).

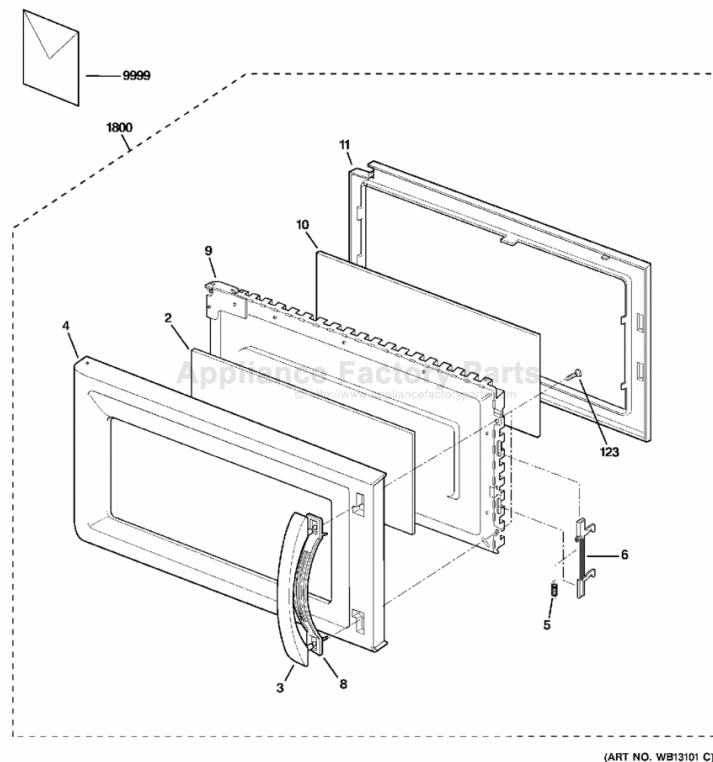

# GE JVM1630BB03 Owner's Manual

[Shop genuine replacement parts for GE JVM1630BB03](#)



[Find Your GE Microwave Parts - Select From 3055 Models](#)

----- Manual continues below -----

# EXPLODED VIEW

JVM1630

## DOOR PARTS

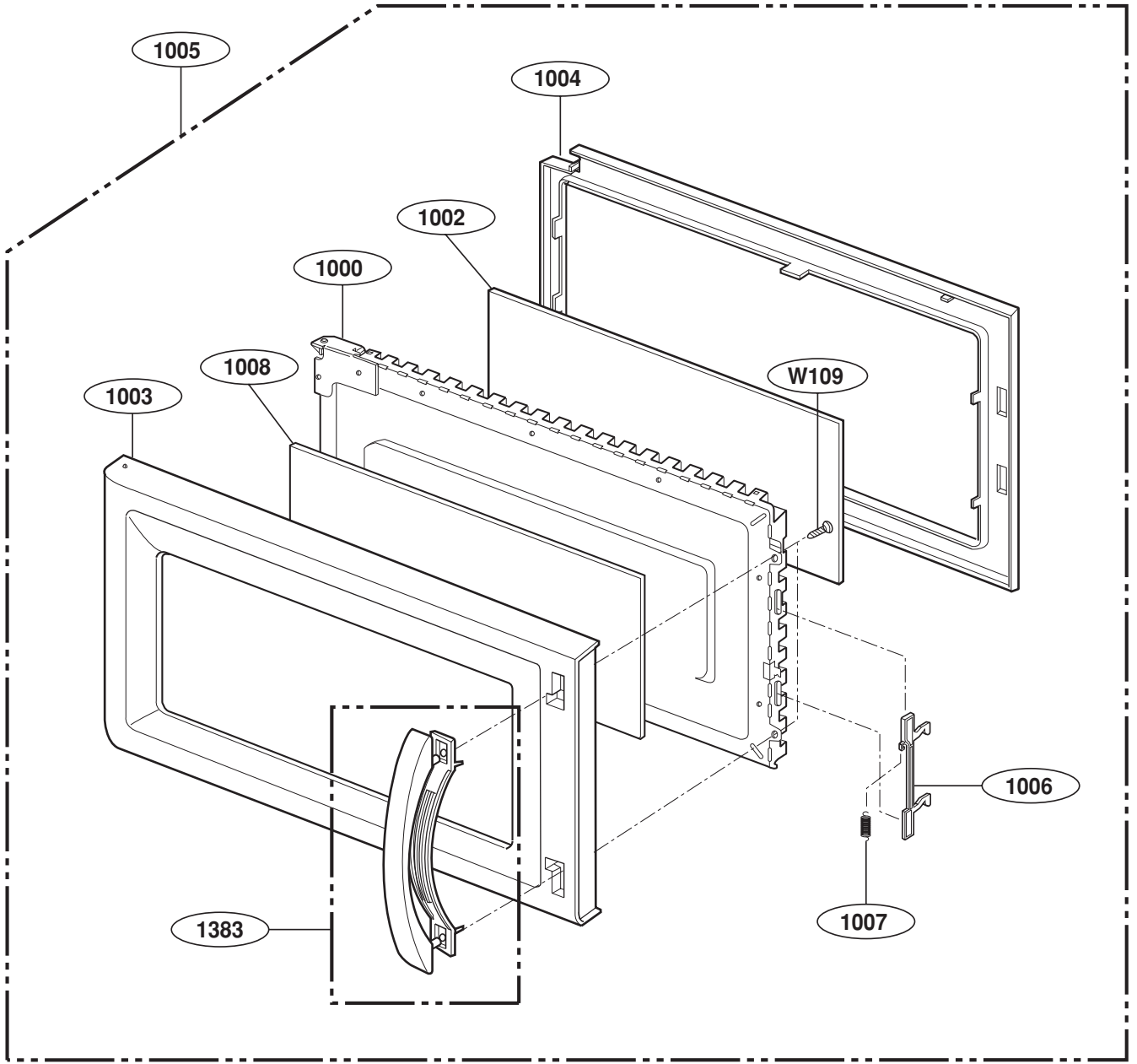

9382



HARDWARE BAG

P/No: 3828W5S5157

# CONTROLLER PARTS

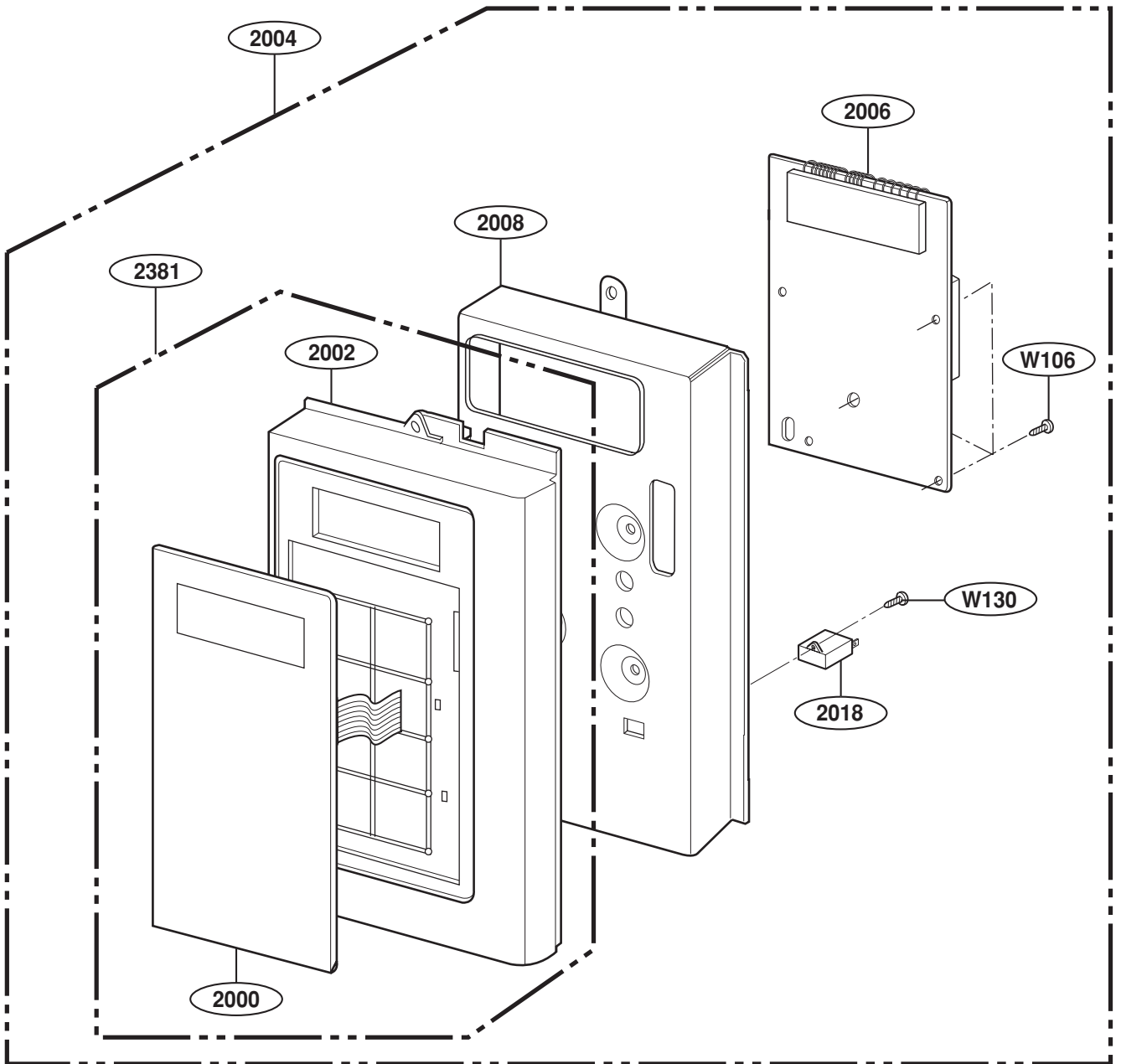

# OVEN CAVITY PARTS



# LATCH BOARD PARTS



# INTERIOR PARTS (I)

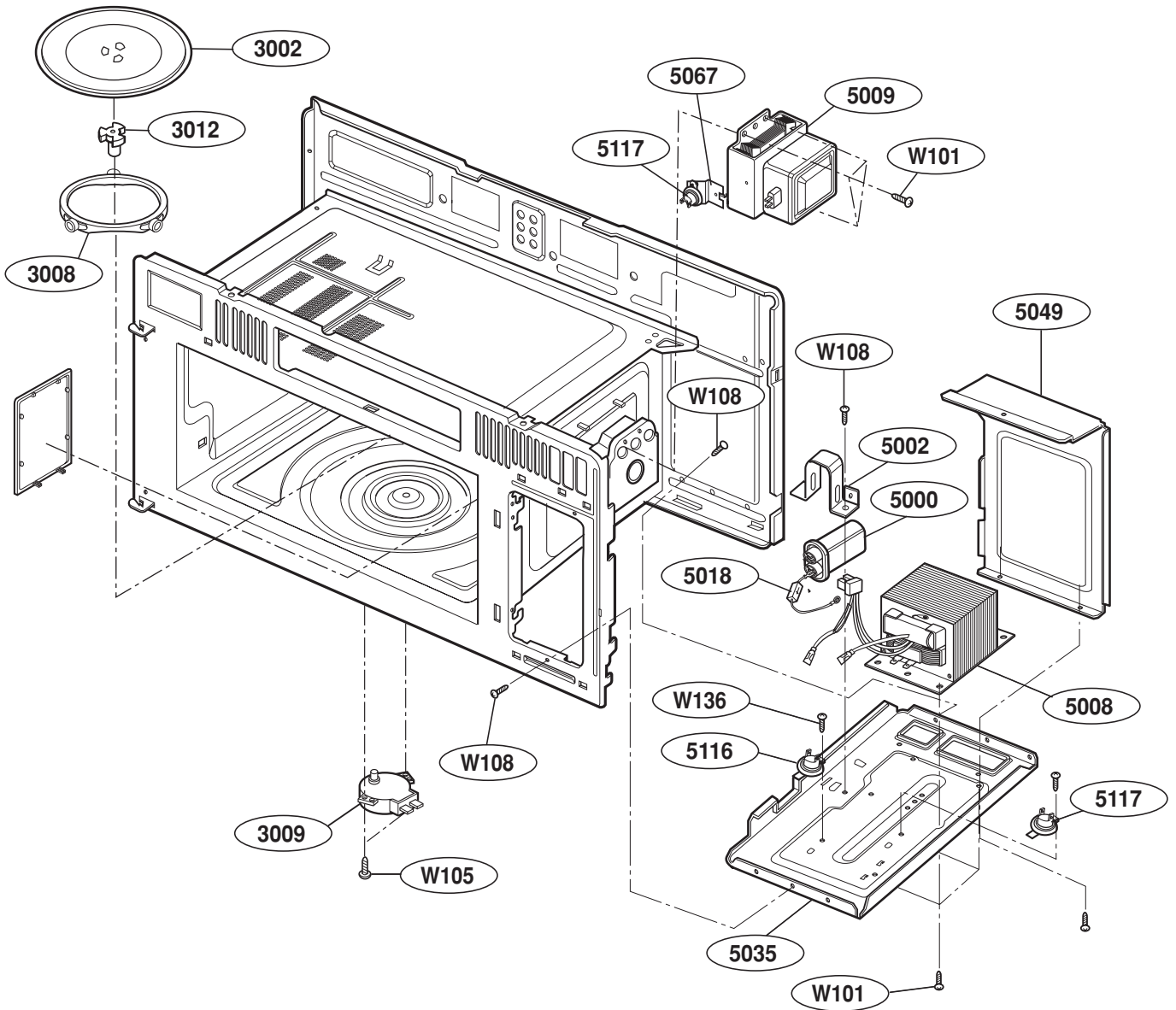

# INTERIOR PARTS (II - I)

Model: JVM1630WH 003  
JVM1630BH 003  
JVM1630CH 003  
JVM1630WJ 01 / 02  
JVM1630BJ 01 / 02  
JVM1630CJ 01 / 02

Check the rating label of **Model** and order SVC parts according to the **Model No.**

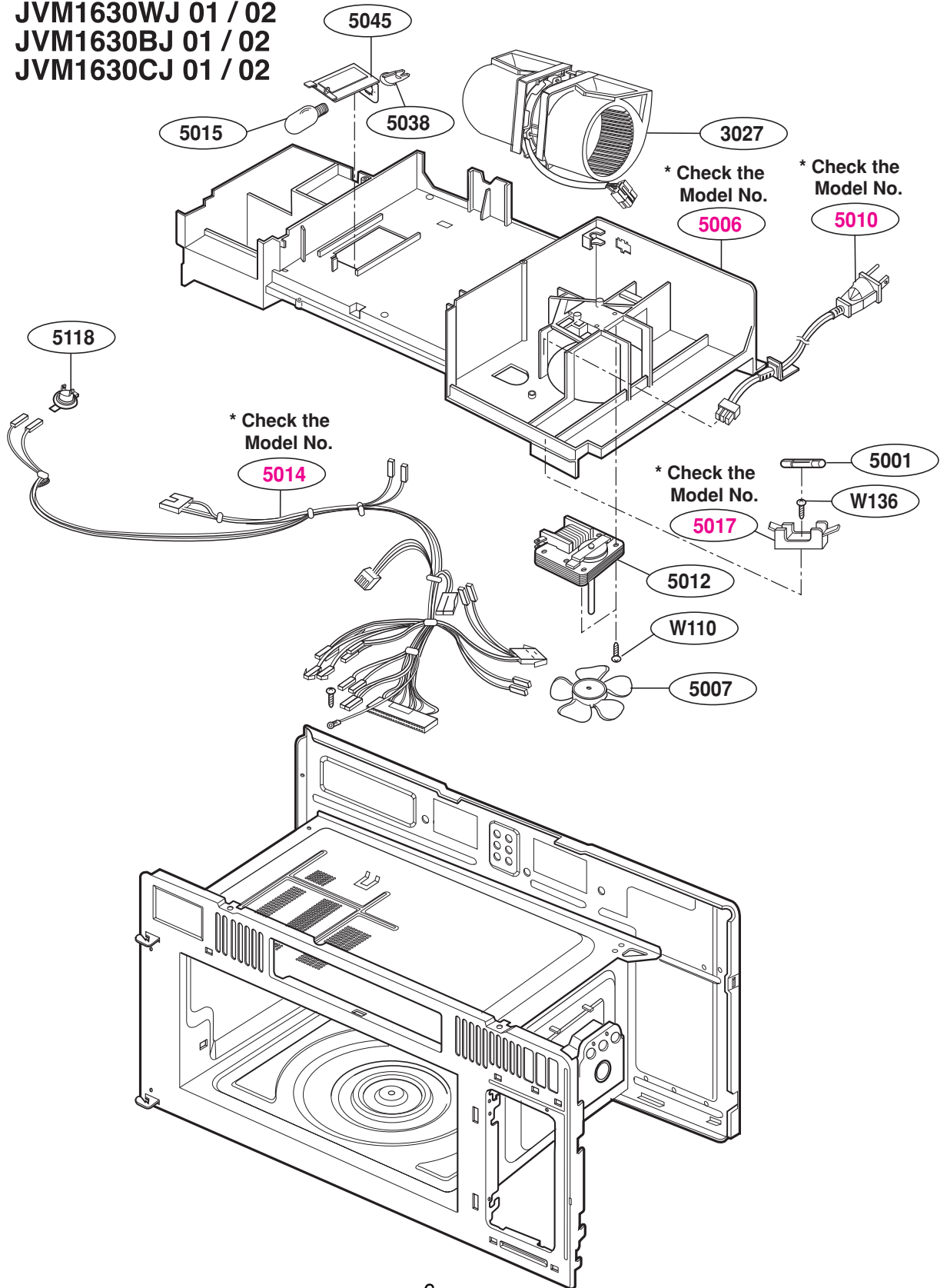

# INSTALLATION PARTS

