

This Owner's Manual is provided and hosted by [Appliance Factory Parts](#).



GE JVM1650WB03 Owner's Manual

[Shop genuine replacement parts for GE JVM1650WB03](#)



[Find Your GE Microwave Parts - Select From 3055 Models](#)

----- Manual continues below -----

EXPLODED VIEW

Model : JVM1650WH 05
JVM1650BH 05
JVM1650CH 05
JVM1650SH 05

DOOR PARTS

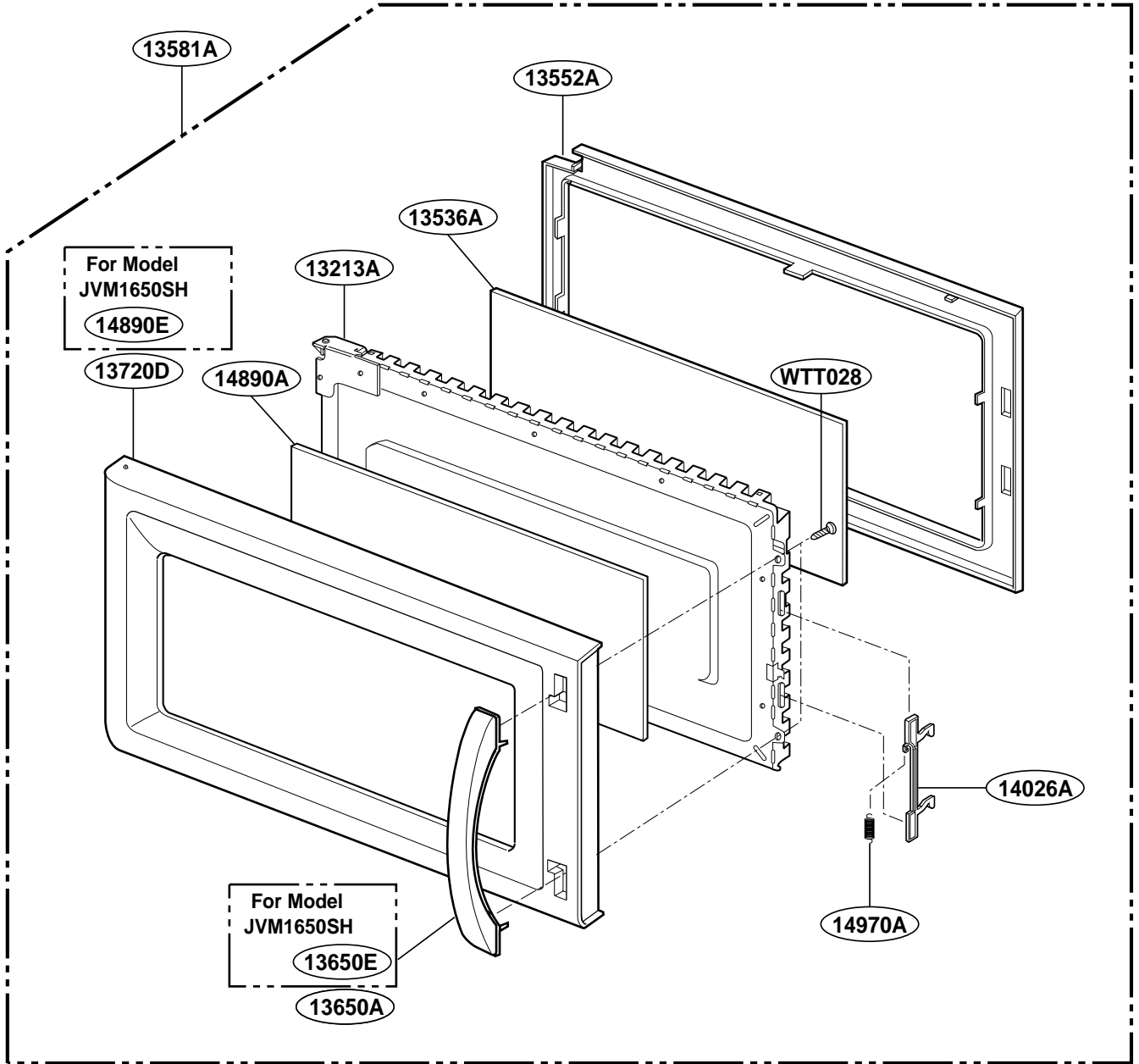

P/No.: 3828W5S5276

CONTROLLER PARTS



OVEN CAVITY PARTS

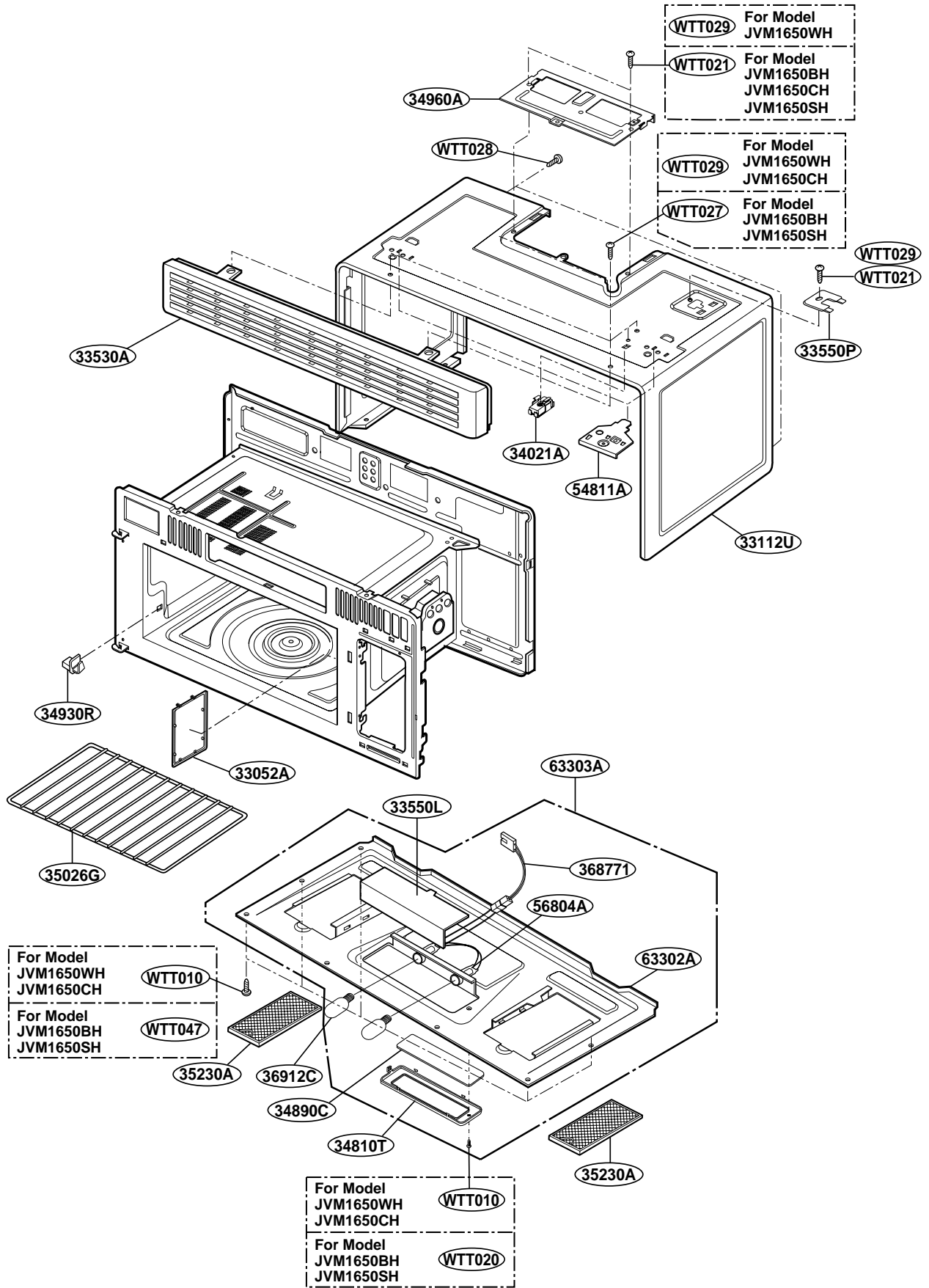

LATCH BOARD PARTS



INTERIOR PARTS (I)

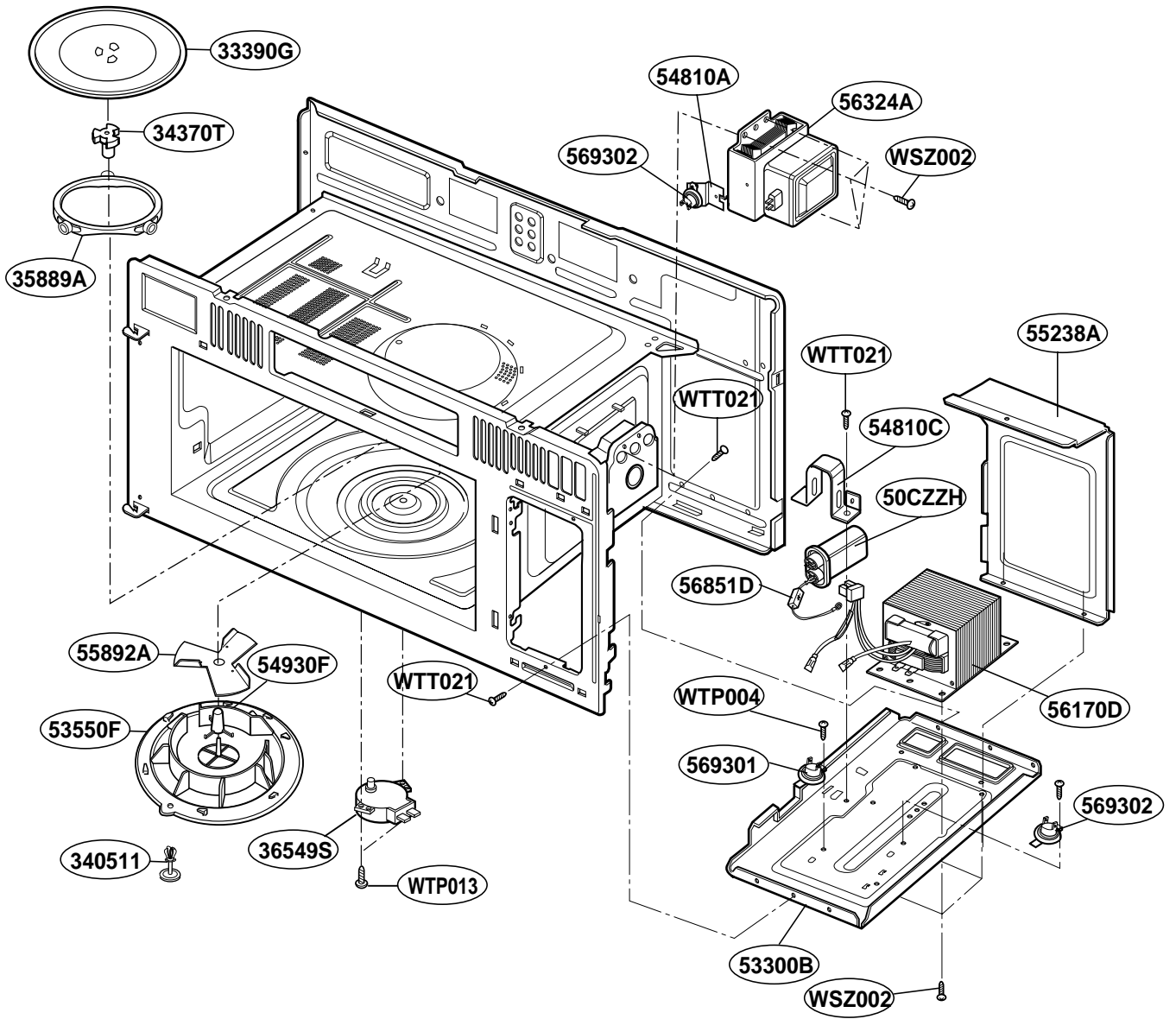

INTERIOR PARTS (II)

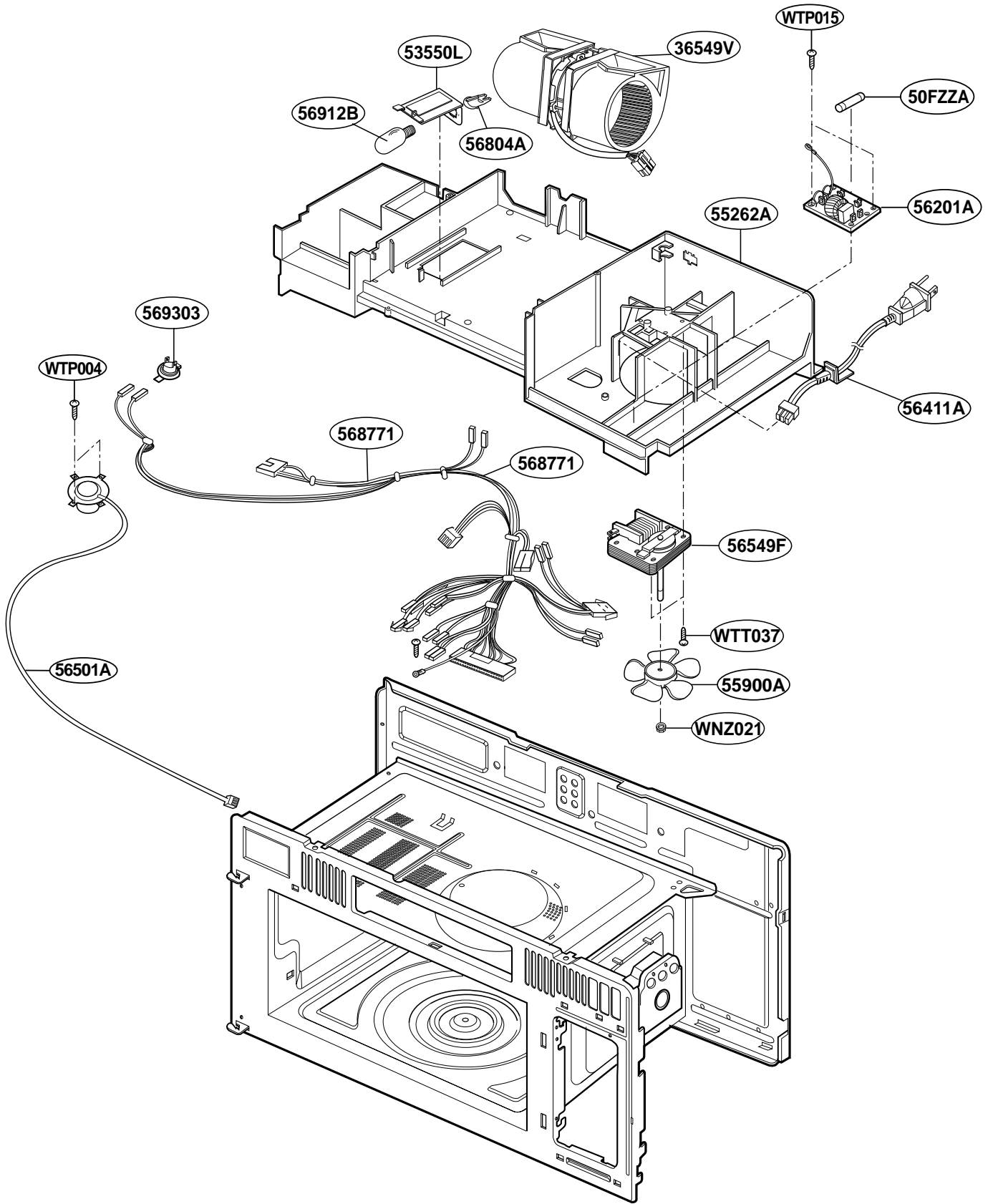

INSTALLATION PARTS

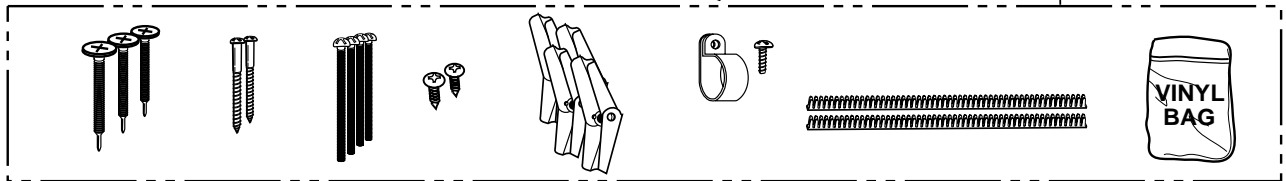
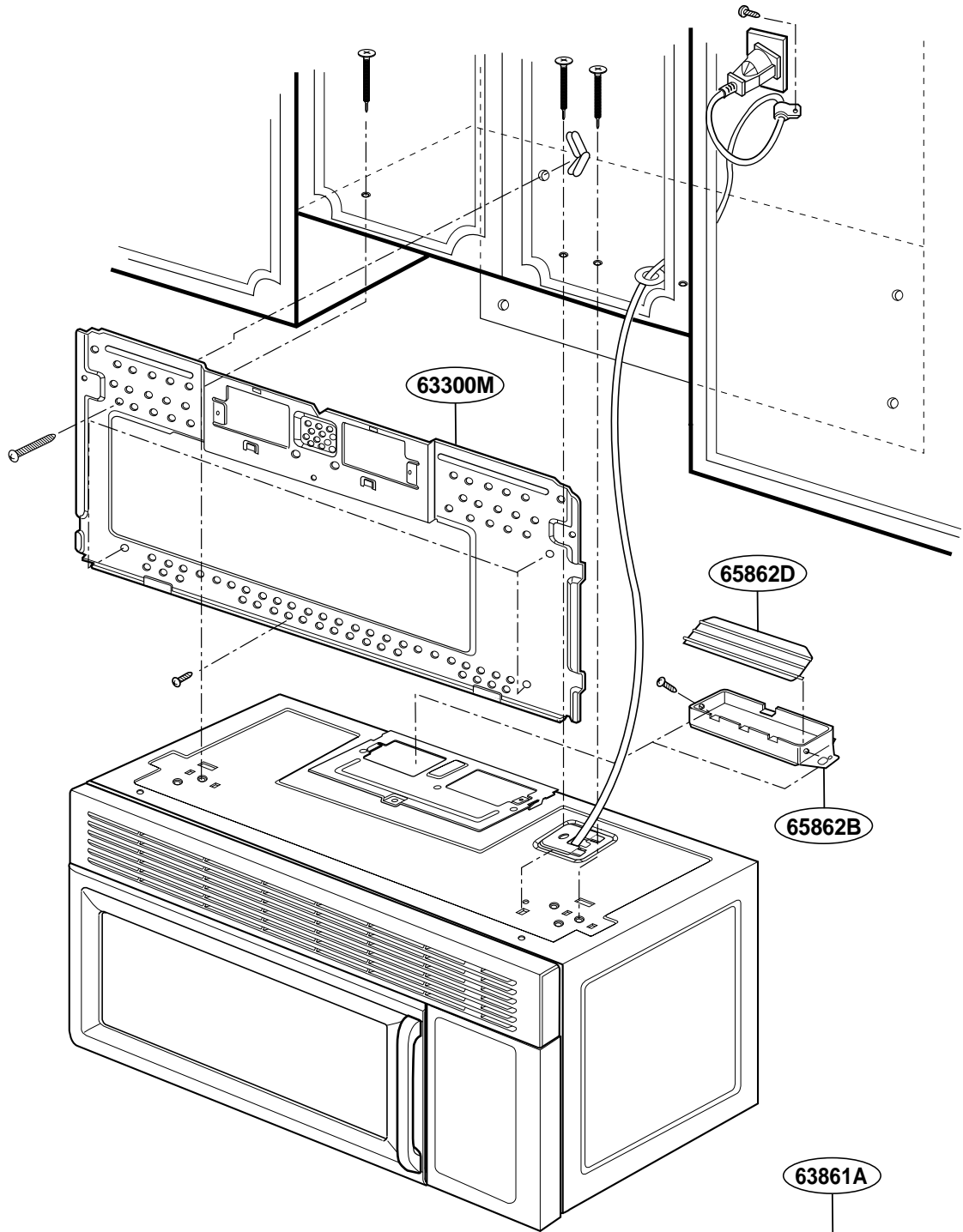

OWNERS
MANUAL

*01

INSTALLATION
MANUAL

*04

COOKING
GUIDE
LABEL

*05

TEMPLATE

*06