

This Owner's Manual is provided and hosted by [Appliance Factory Parts](#).



# GE JVM1650WB04 Owner's Manual

[Shop genuine replacement parts for GE JVM1650WB04](#)



[Find Your GE Microwave Parts - Select From 3055 Models](#)

----- Manual continues below -----

# EXPLODED VIEW

Model : JVM1650WH 05  
JVM1650BH 05  
JVM1650CH 05  
JVM1650SH 05

## DOOR PARTS

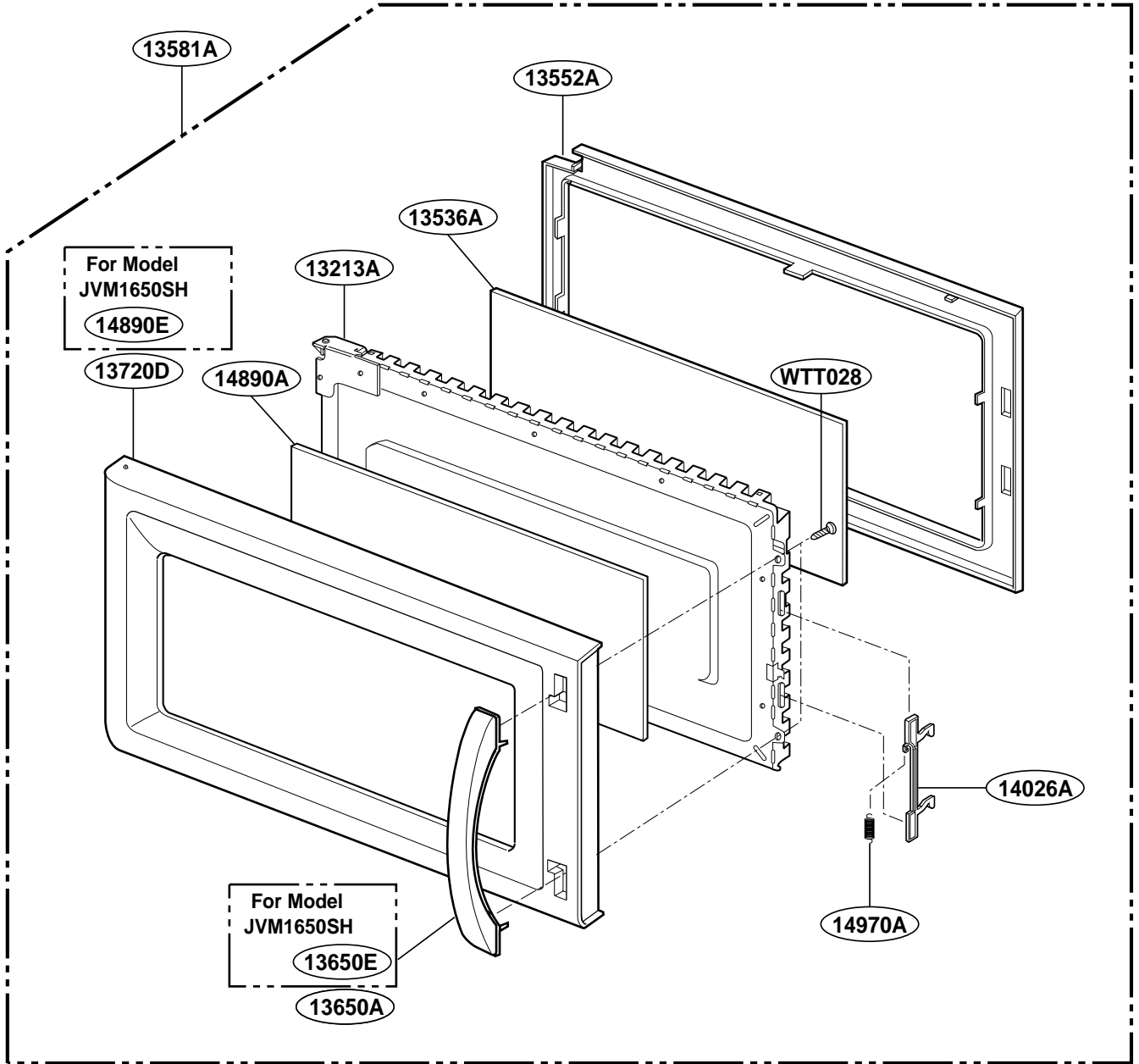

P/No.: 3828W5S5276

# CONTROLLER PARTS



# OVEN CAVITY PARTS

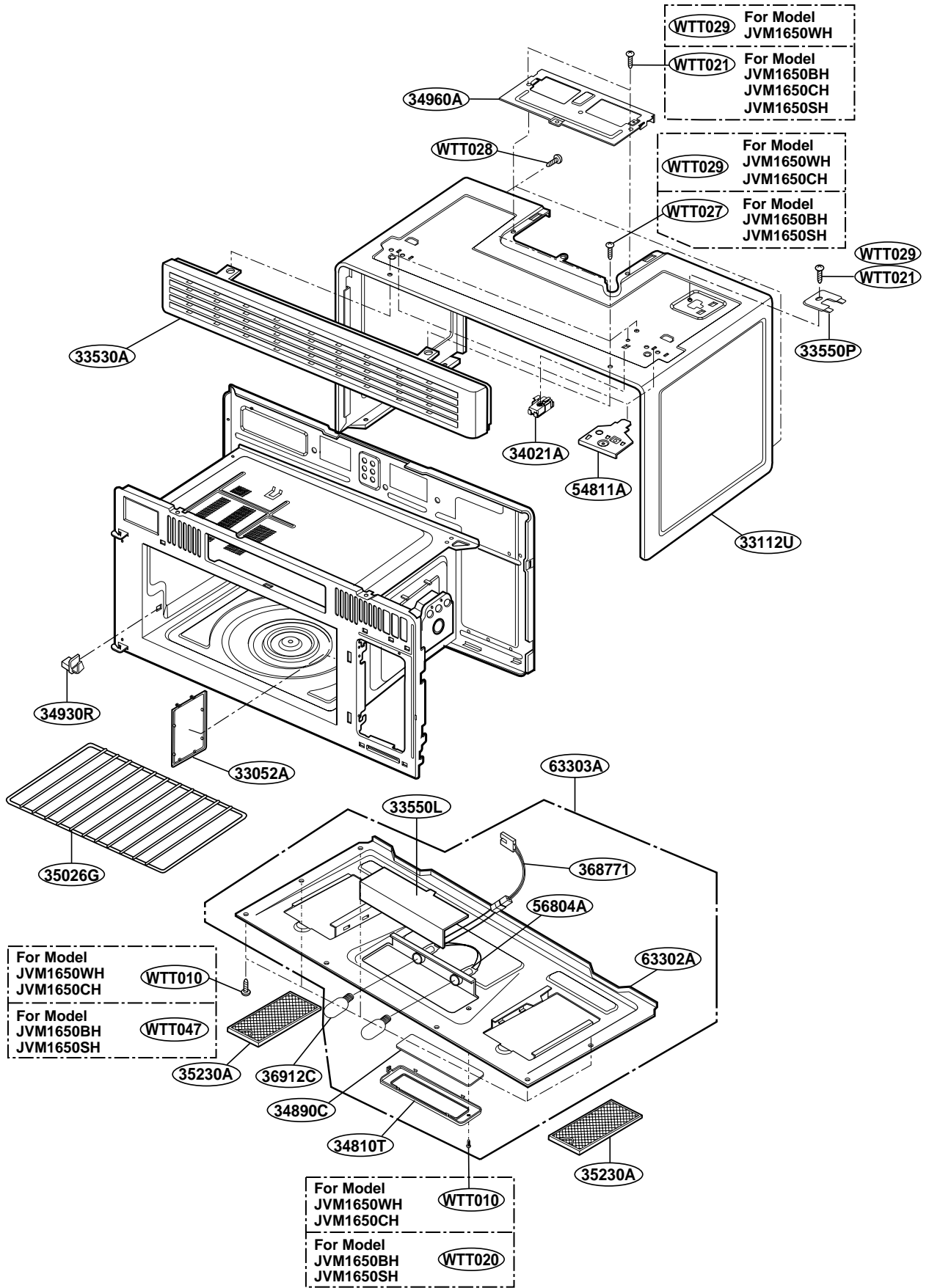

# LATCH BOARD PARTS



# INTERIOR PARTS (I)

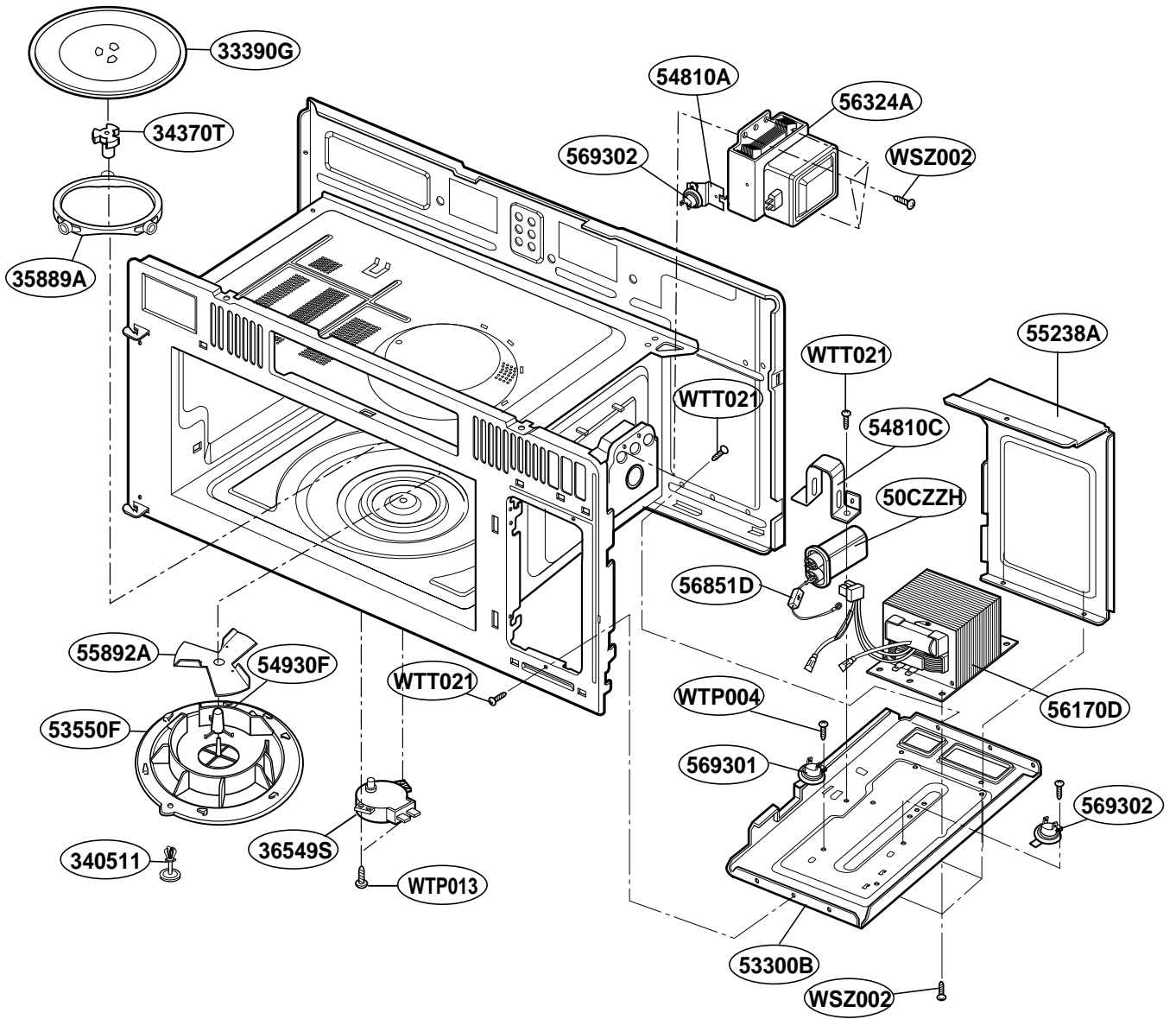

# INTERIOR PARTS (II)

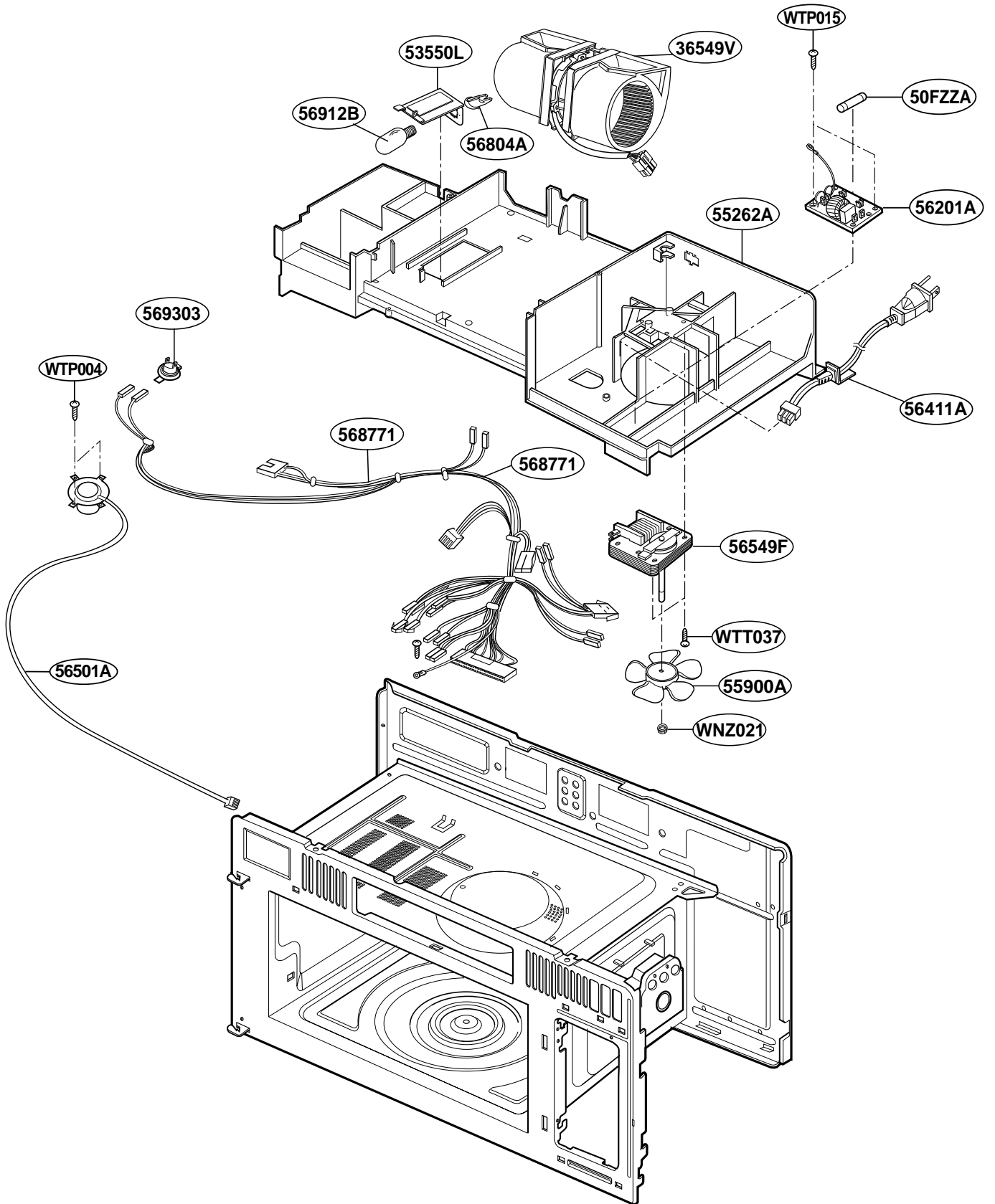

# INSTALLATION PARTS

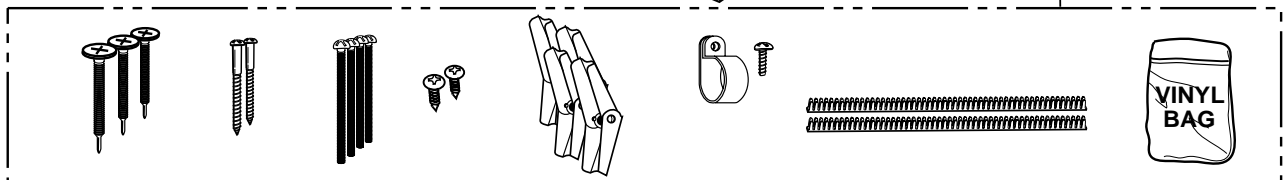
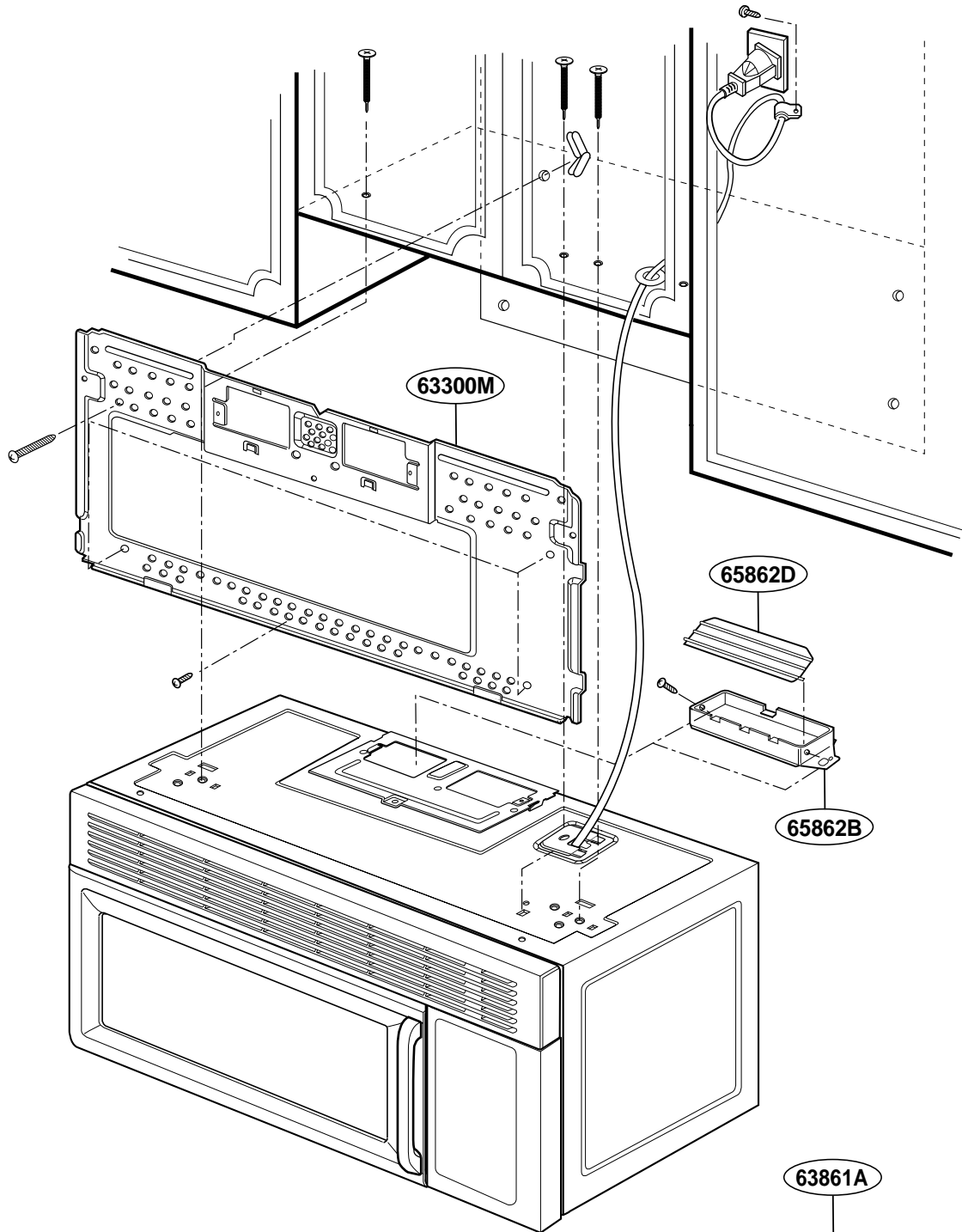

OWNERS  
MANUAL

\*01

INSTALLATION  
MANUAL

\*04

COOKING  
GUIDE  
LABEL

\*05

TEMPLATE

\*06