

This Owner's Manual is provided and hosted by [Appliance Factory Parts](http://ApplianceFactoryParts.com).

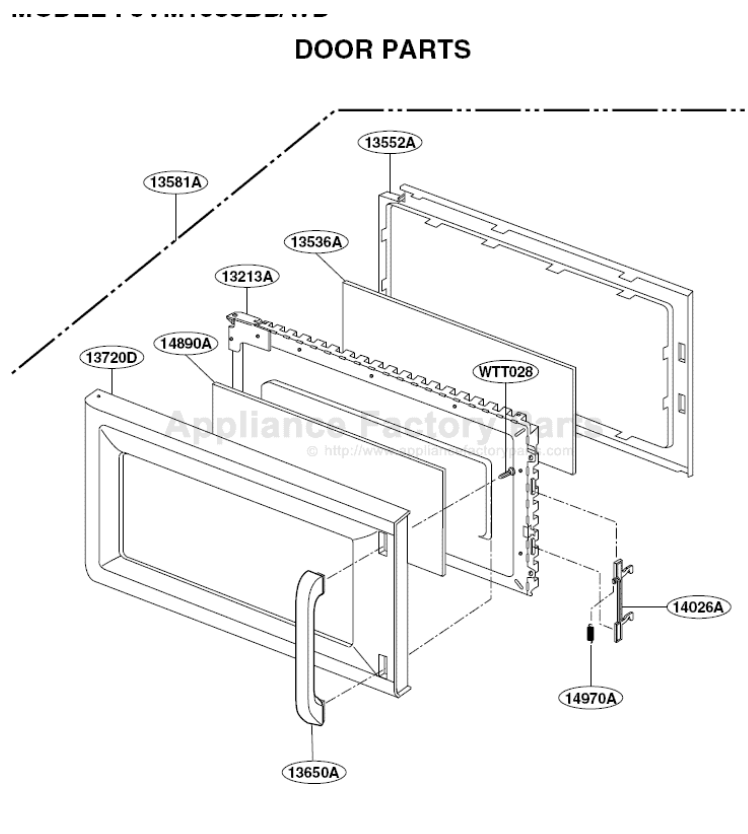

GE JVM1533BD003 Owner's Manual

[Shop genuine replacement parts for GE
JVM1533BD003](#)



[Find Your GE Microwave Parts - Select From 3055 Models](#)

----- Manual continues below -----

EXPLODED VIEW

MODEL : JVM1533BD/WD

DOOR PARTS

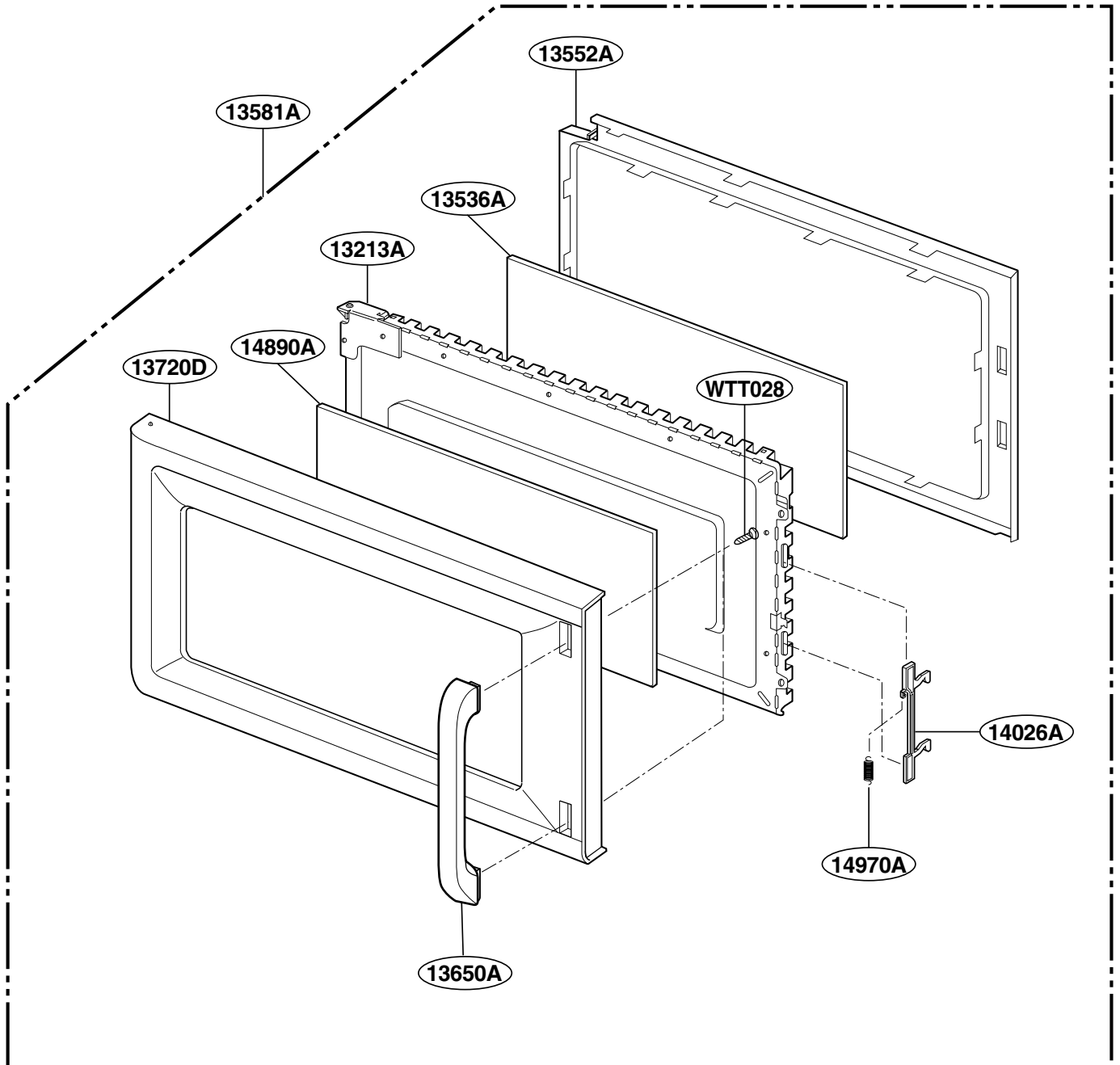

P/No: 3828W5S3292

CONTROLLER PARTS

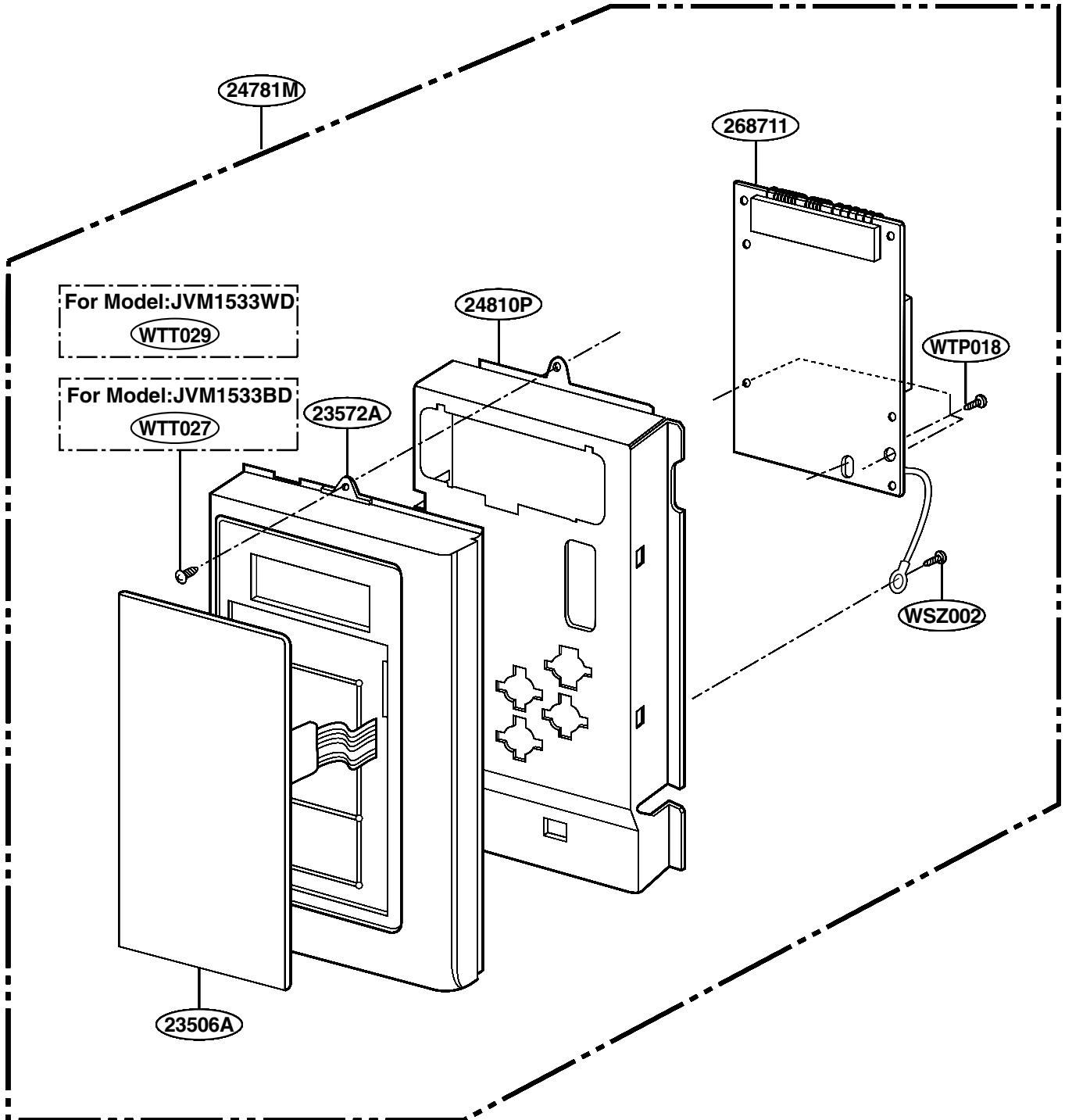

OVEN CAVITY PARTS

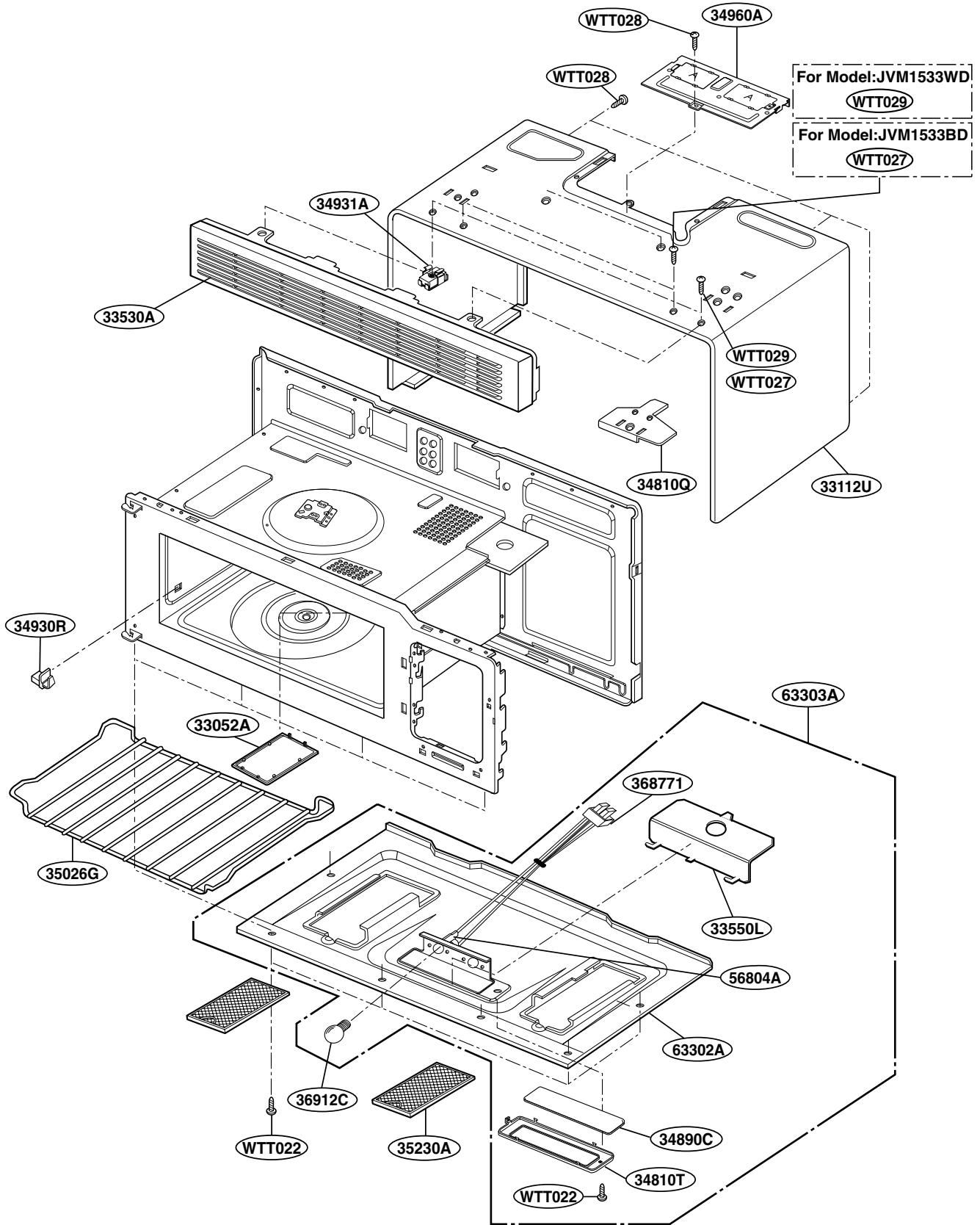

LATCH BOARD PARTS

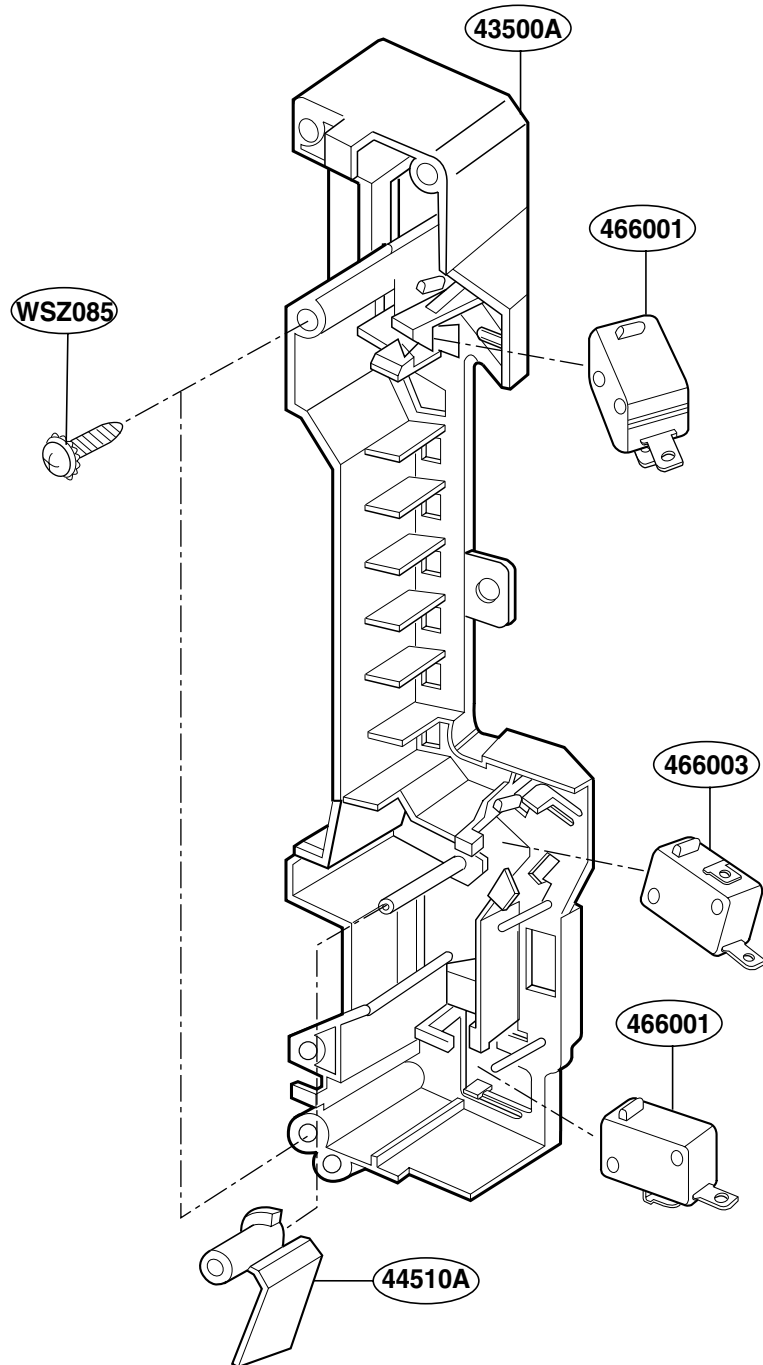

INTERIOR PARTS(I)

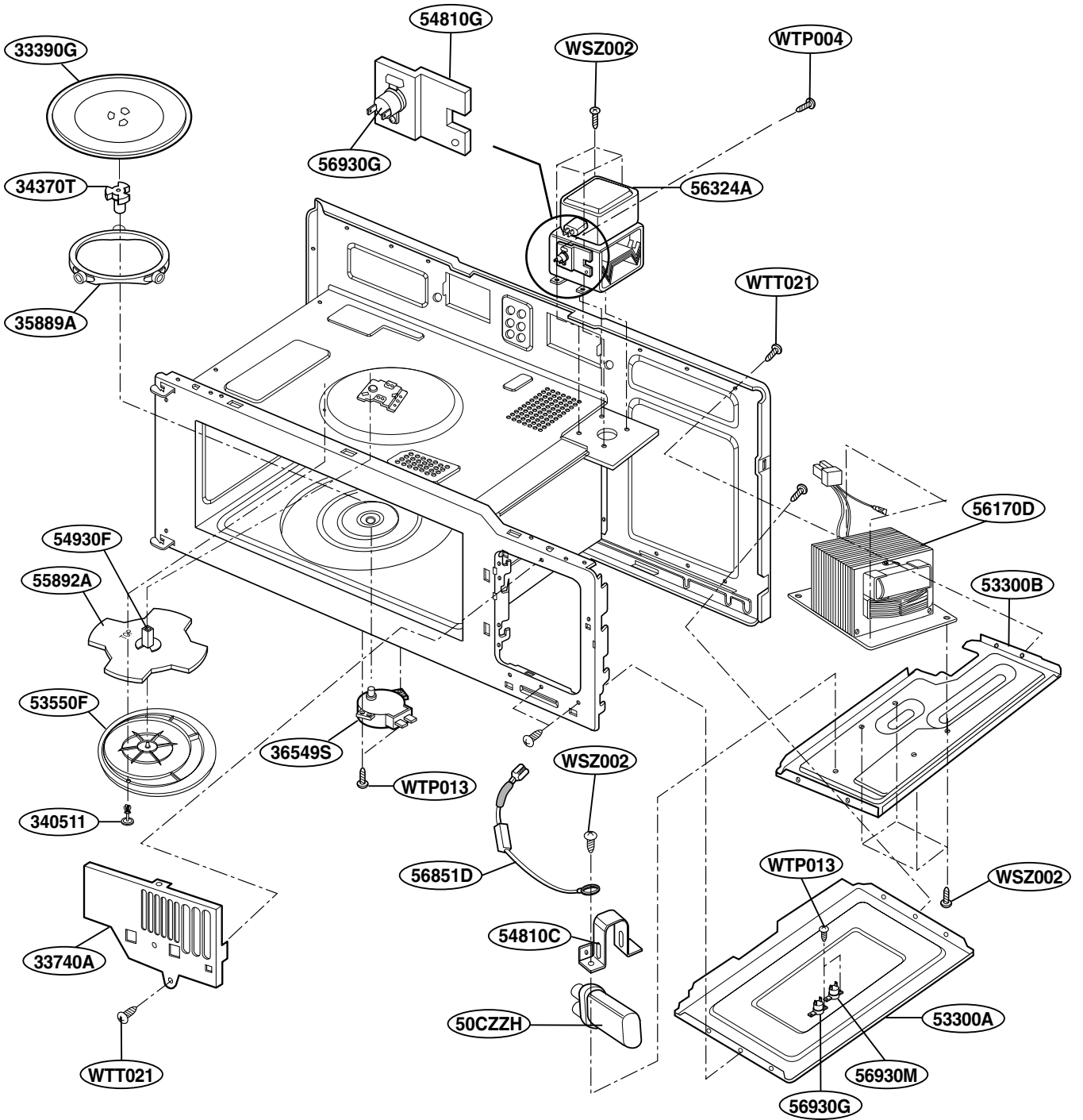

INTERIOR PARTS (II)

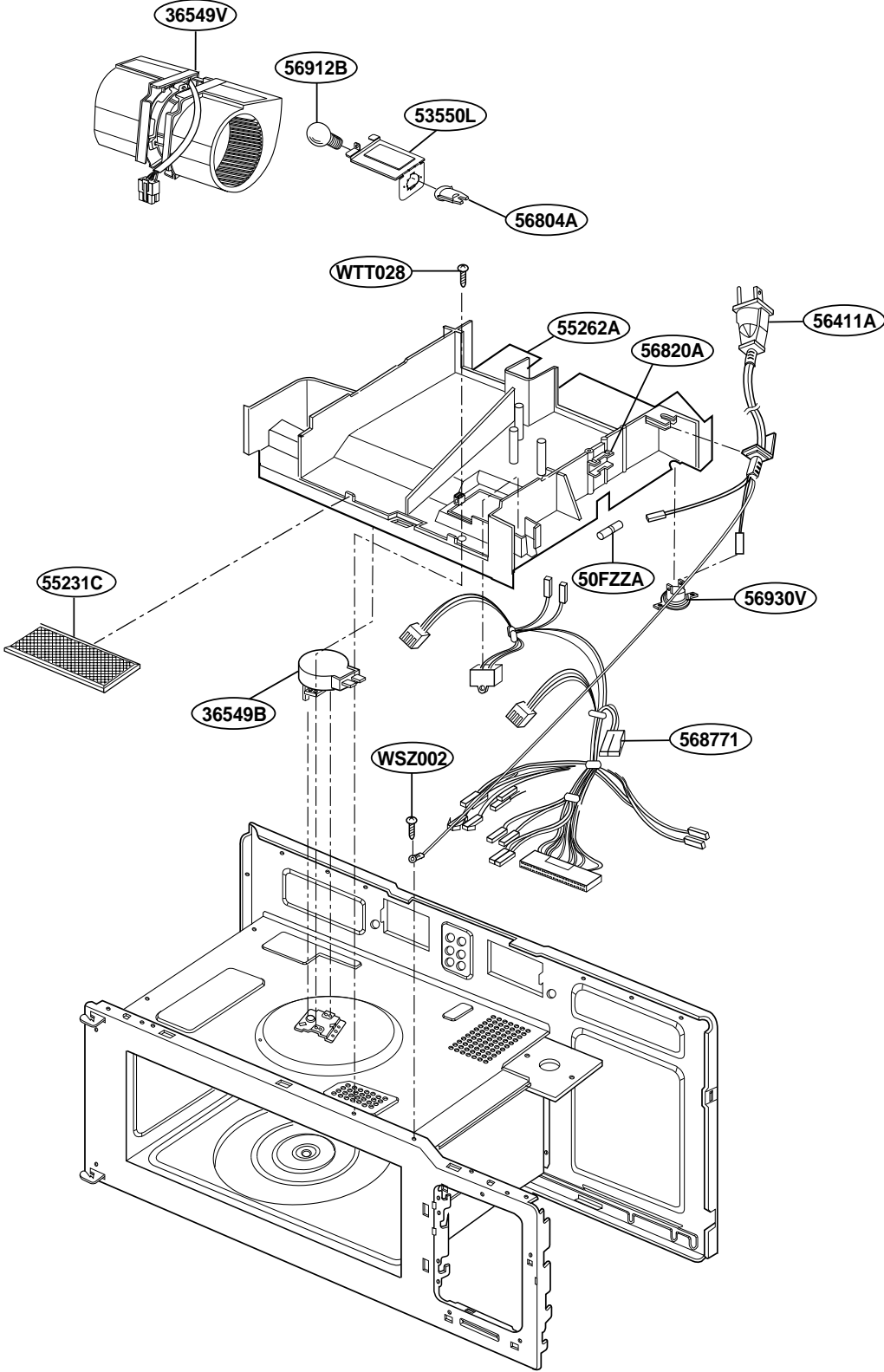

INSTALLATION PARTS

