

This Owner's Manual is provided and hosted by [Appliance Factory Parts](#).

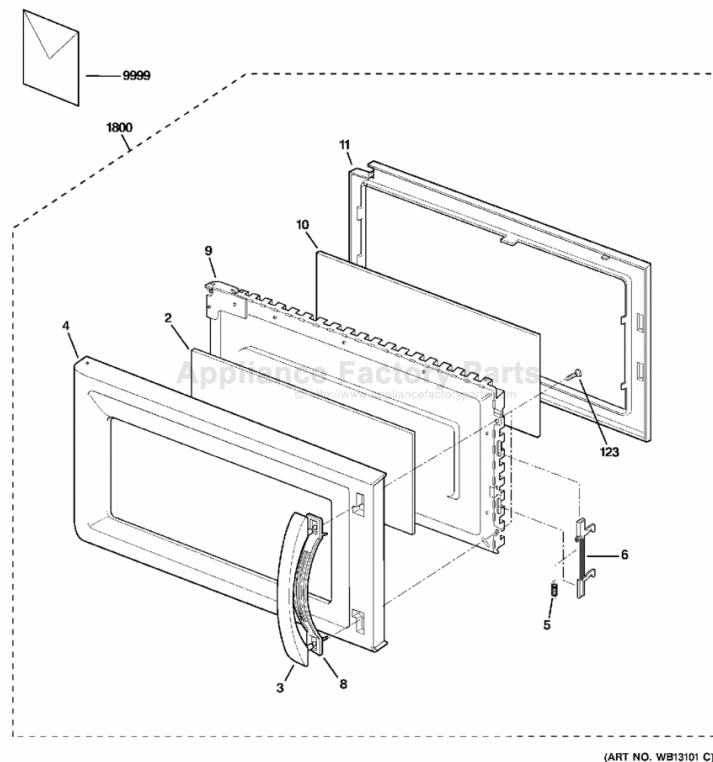

GE JVM1630BB002 Owner's Manual

[Shop genuine replacement parts for GE
JVM1630BB002](#)



[Find Your GE Microwave Parts - Select From 3055 Models](#)

----- Manual continues below -----

EXPLODED VIEW

JVM1630

DOOR PARTS

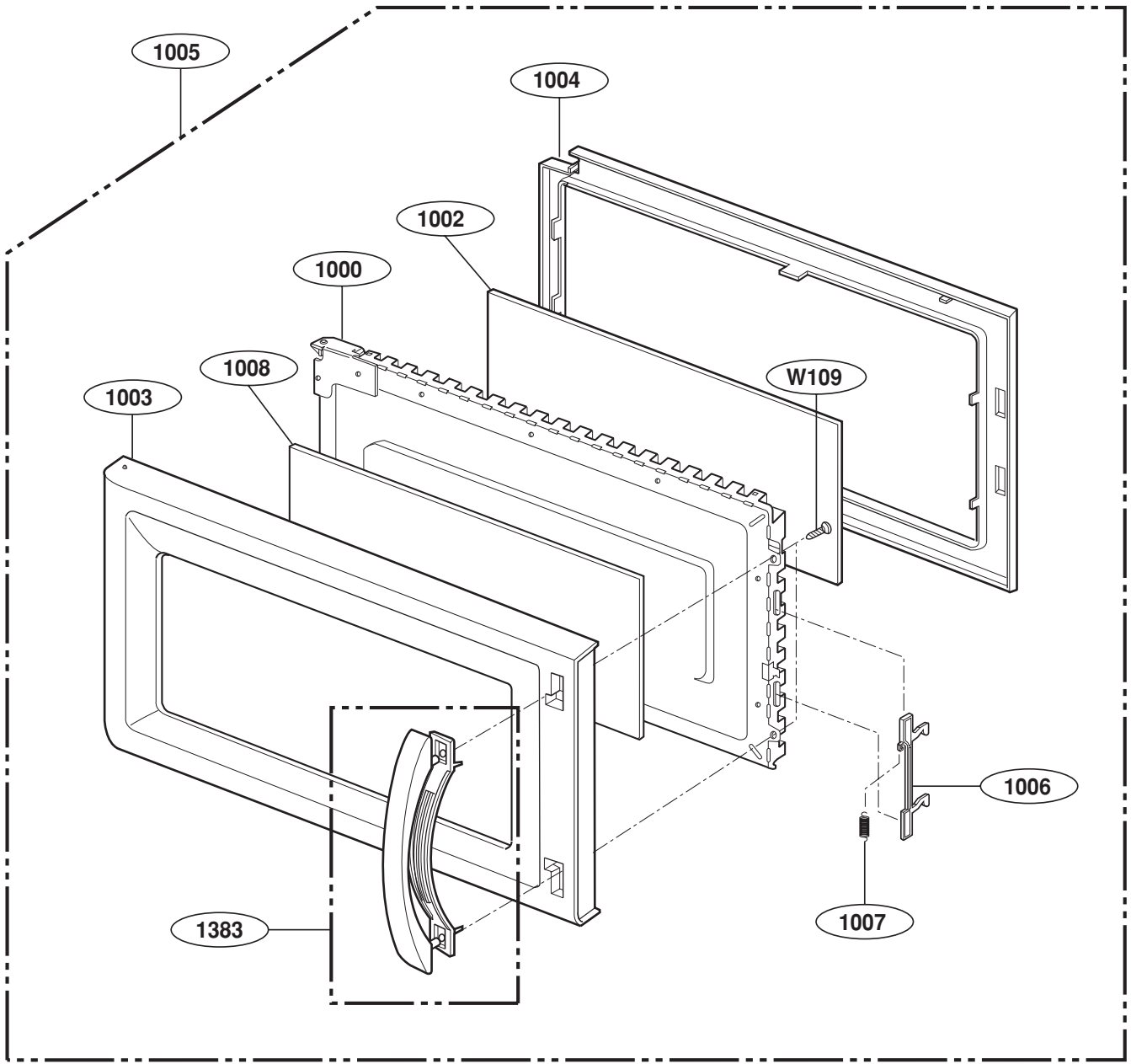

9382



HARDWARE BAG

P/No: 3828W5S5157

CONTROLLER PARTS

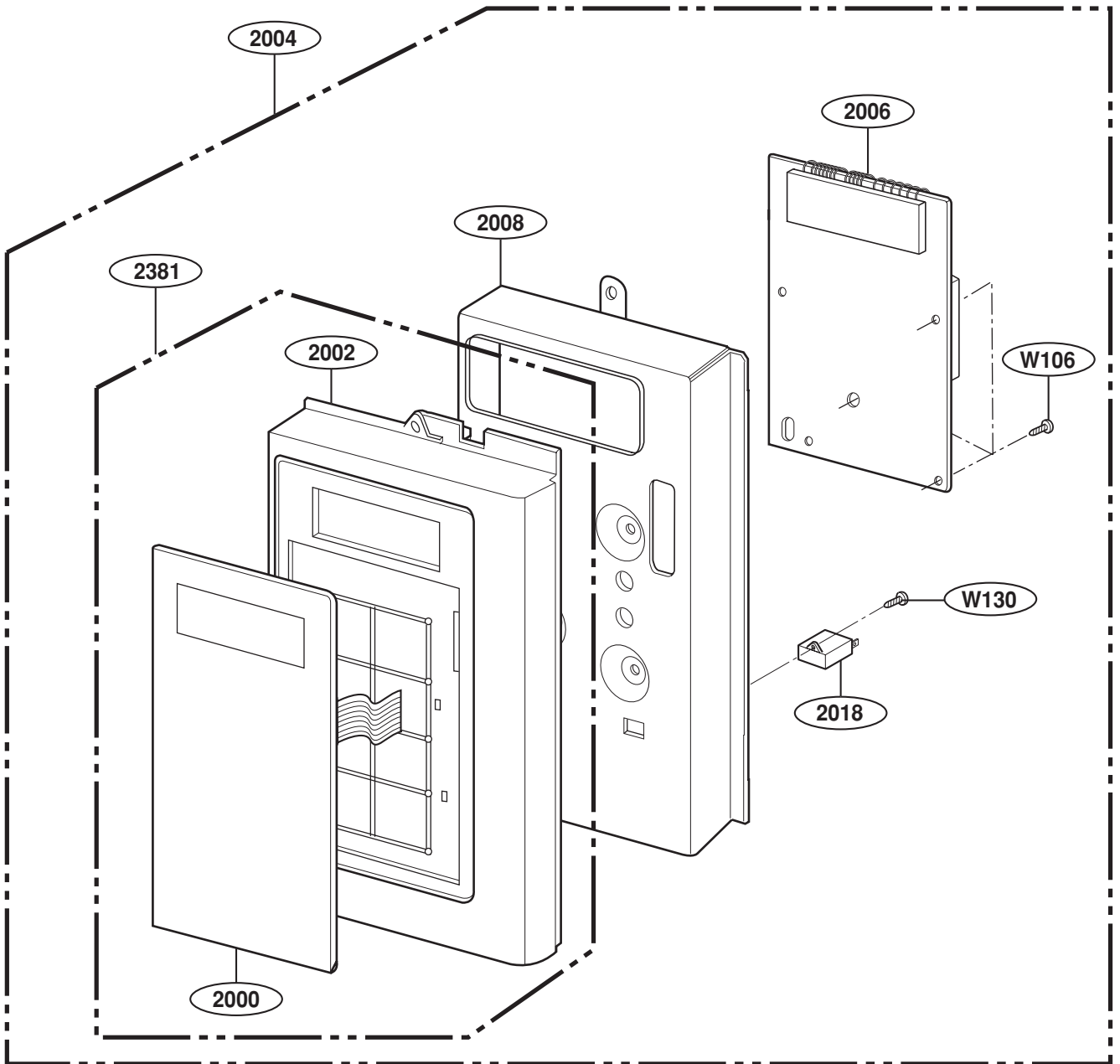

OVEN CAVITY PARTS



LATCH BOARD PARTS



INTERIOR PARTS (I)

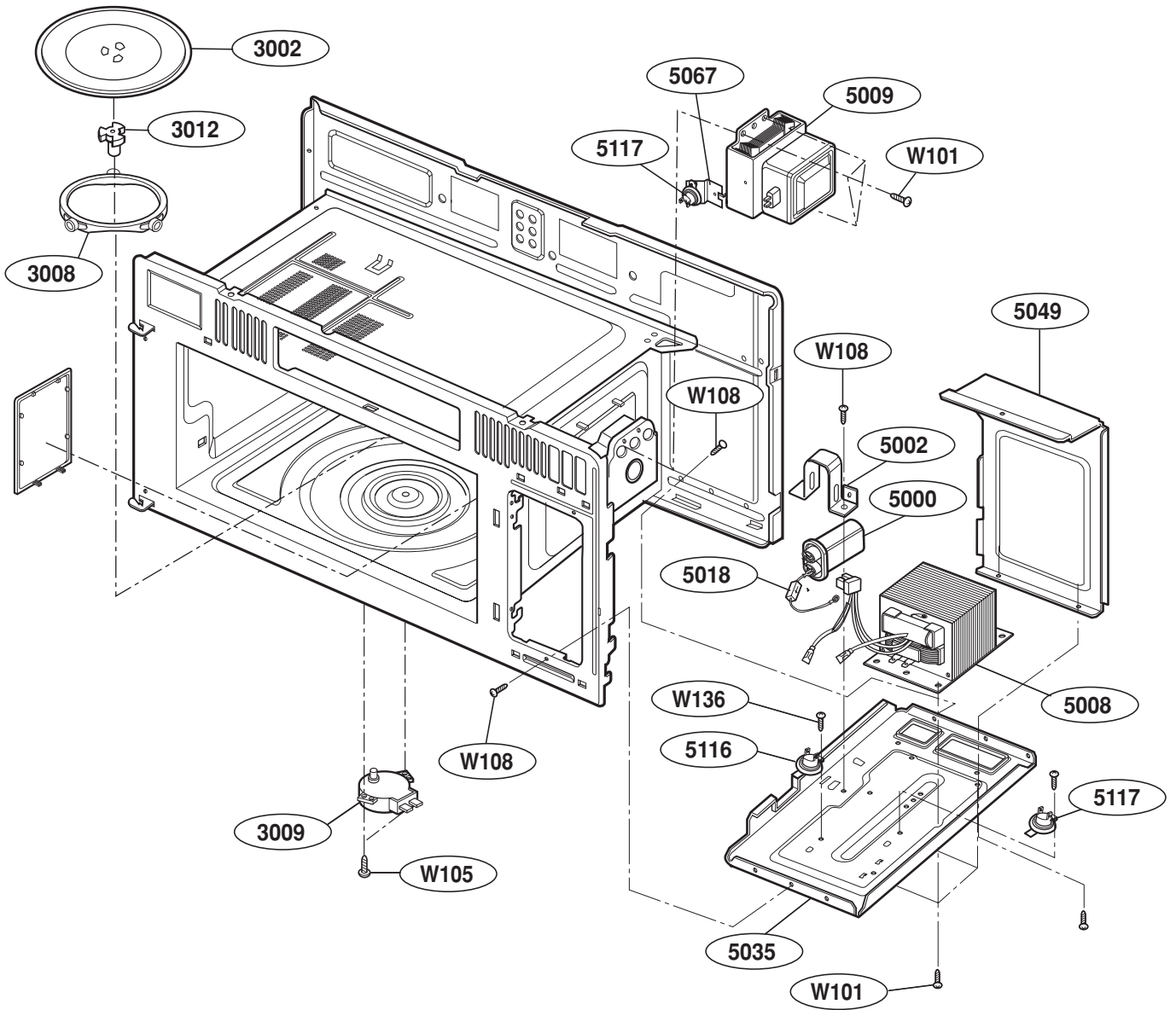

INTERIOR PARTS (II - I)

Model: JVM1630WH 003
JVM1630BH 003
JVM1630CH 003
JVM1630WJ 01 / 02
JVM1630BJ 01 / 02
JVM1630CJ 01 / 02

Check the rating label of **Model** and order SVC parts according to the **Model No.**

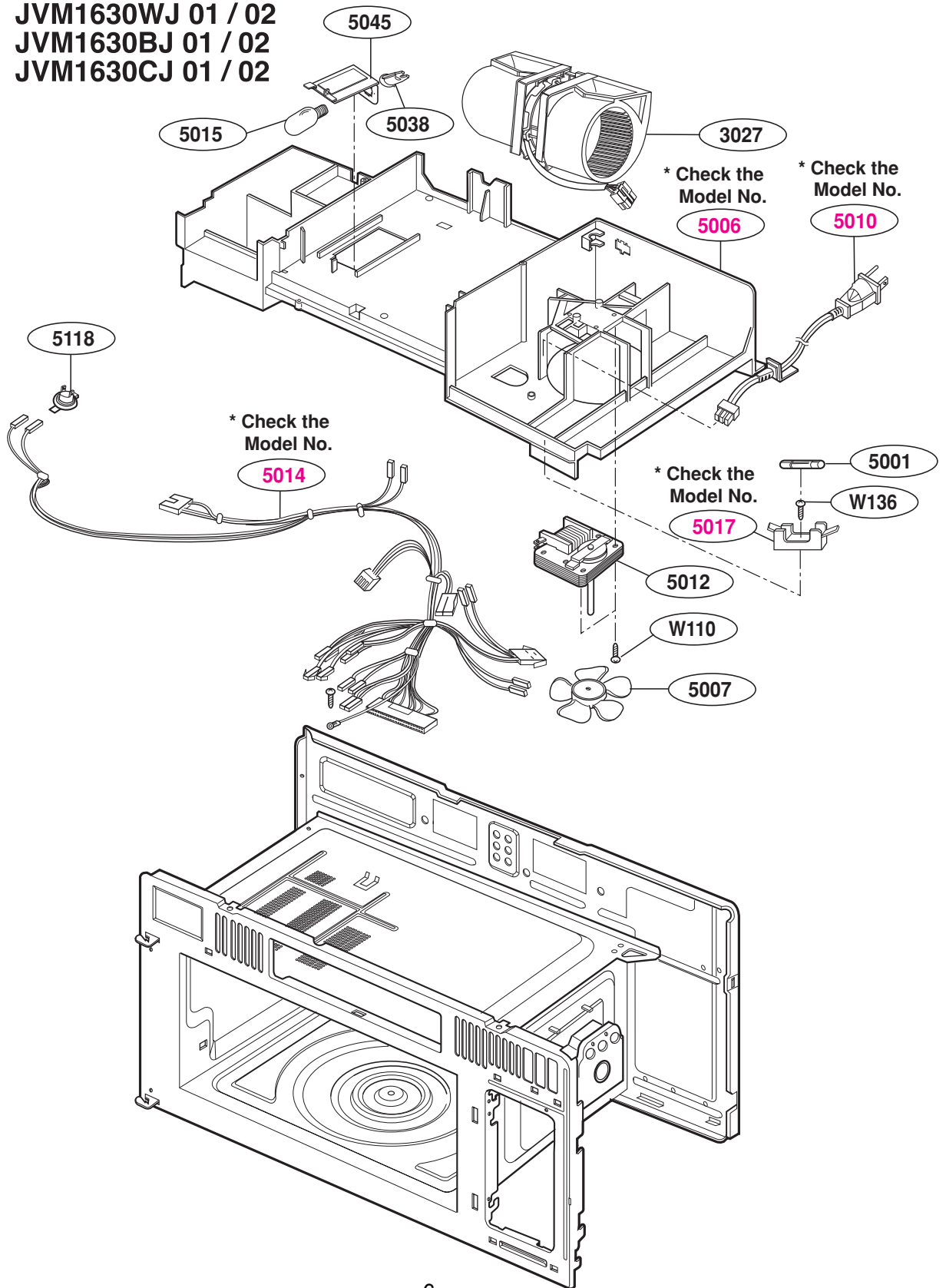

INSTALLATION PARTS

