

This Owner's Manual is provided and hosted by [Appliance Factory Parts](http://www.ApplianceFactoryParts.com).



GE JVM1631WH003 Owner's Manual

[Shop genuine replacement parts for GE
JVM1631WH003](#)

DOOR PARTS

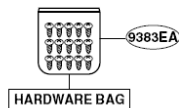
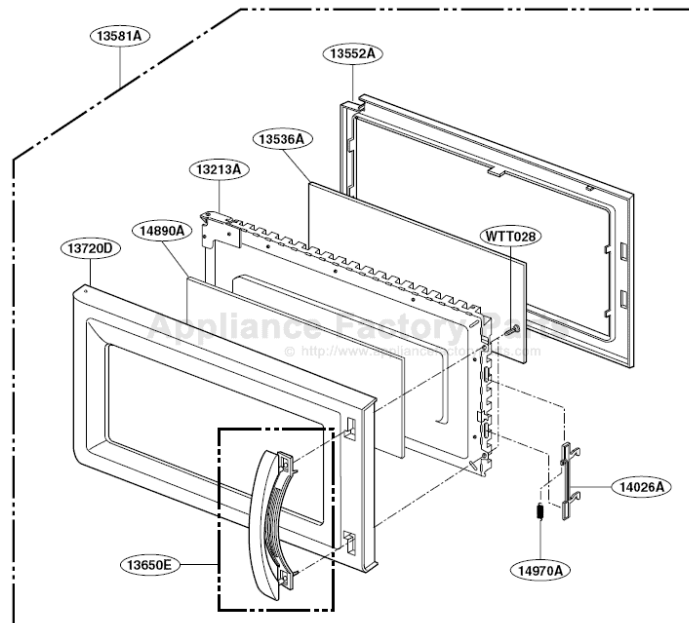

P/No: 3828W5S5154

[Find Your GE Microwave Parts - Select From 3055 Models](#)

----- Manual continues below -----

EXPLODED VIEW

JVM1631

DOOR PARTS

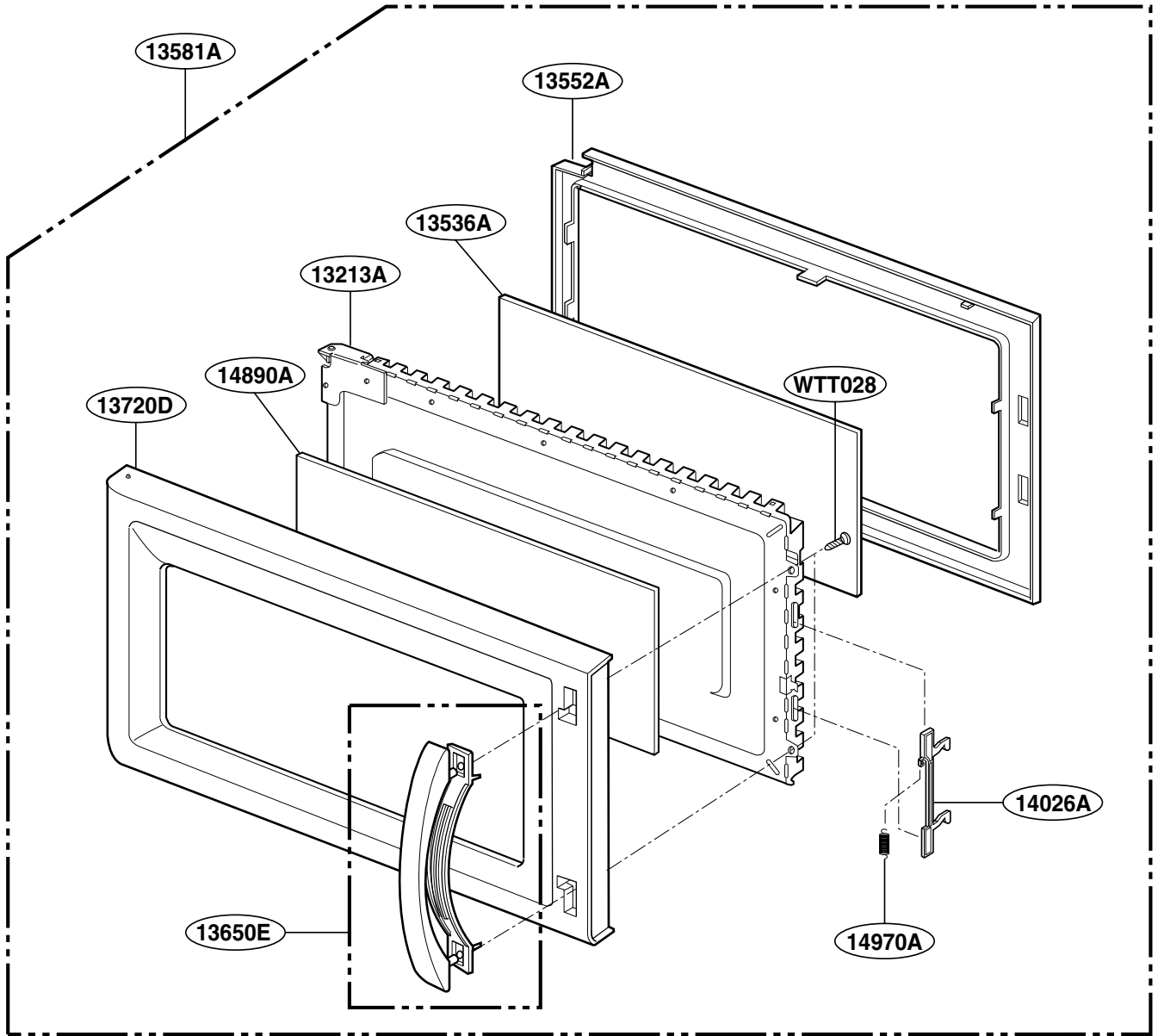

9383EA

HARDWARE BAG

P/No: 3828W5S5154

CONTROLLER PARTS

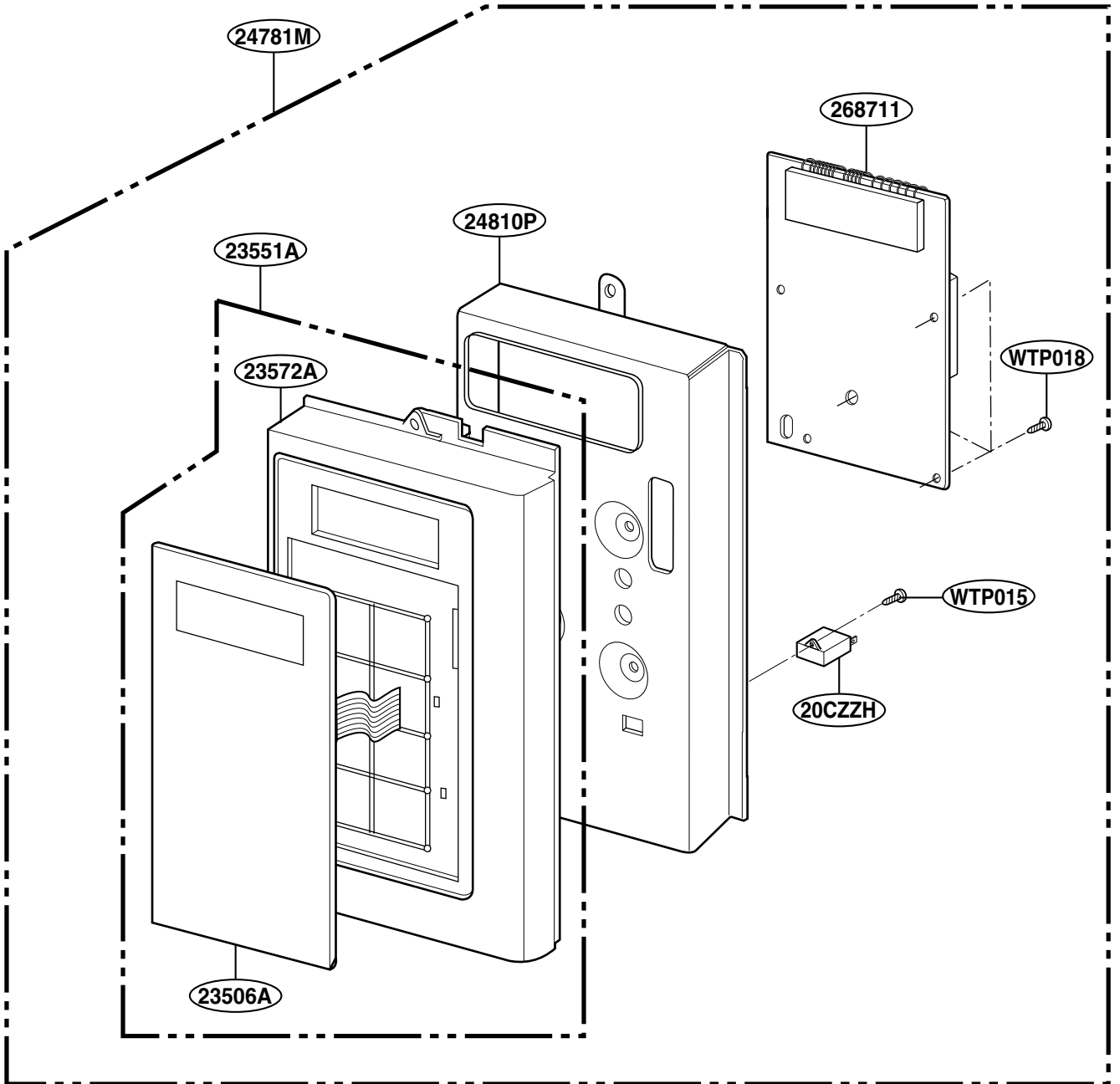

OVEN CAVITY PARTS

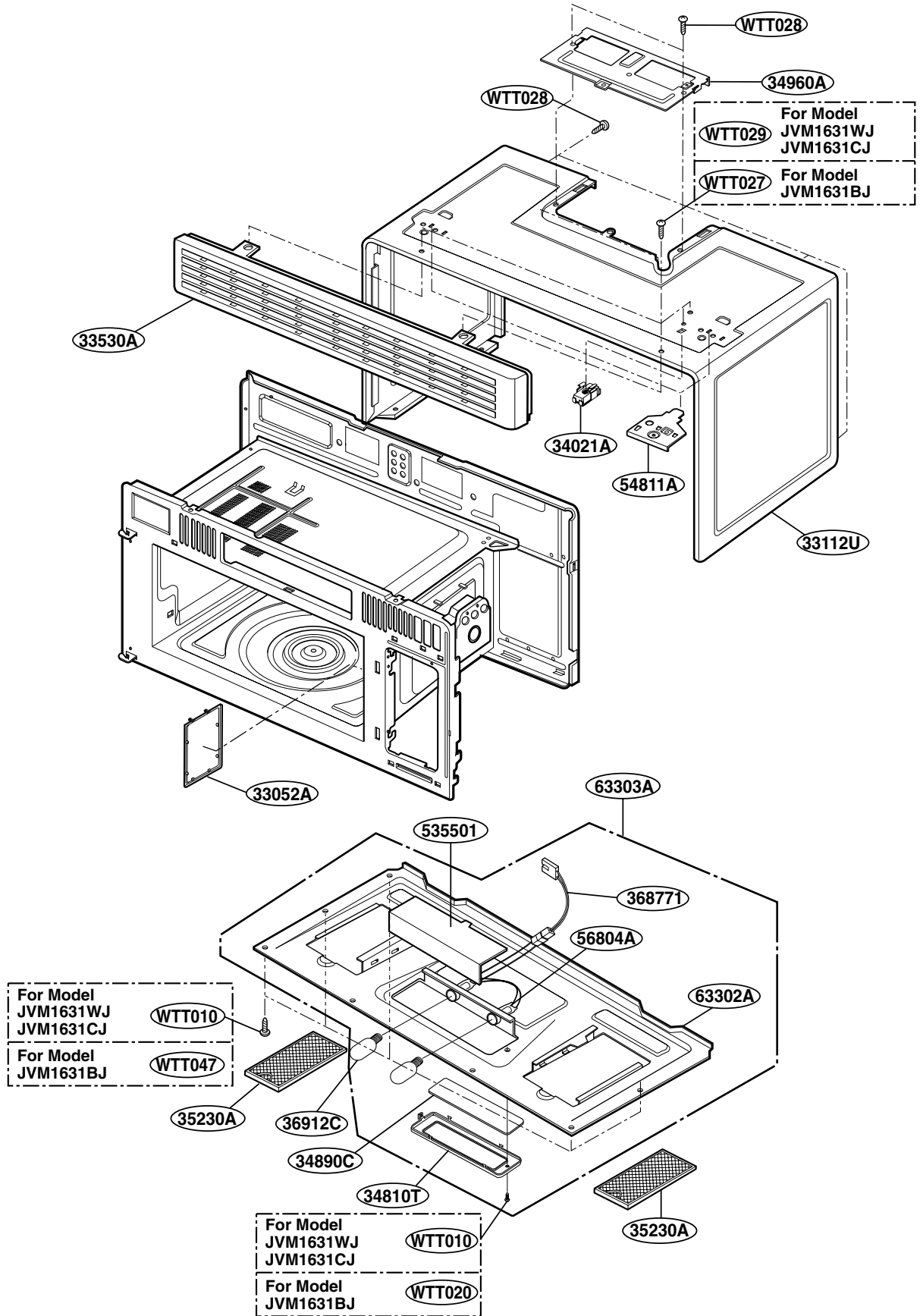

LATCH BOARD PARTS

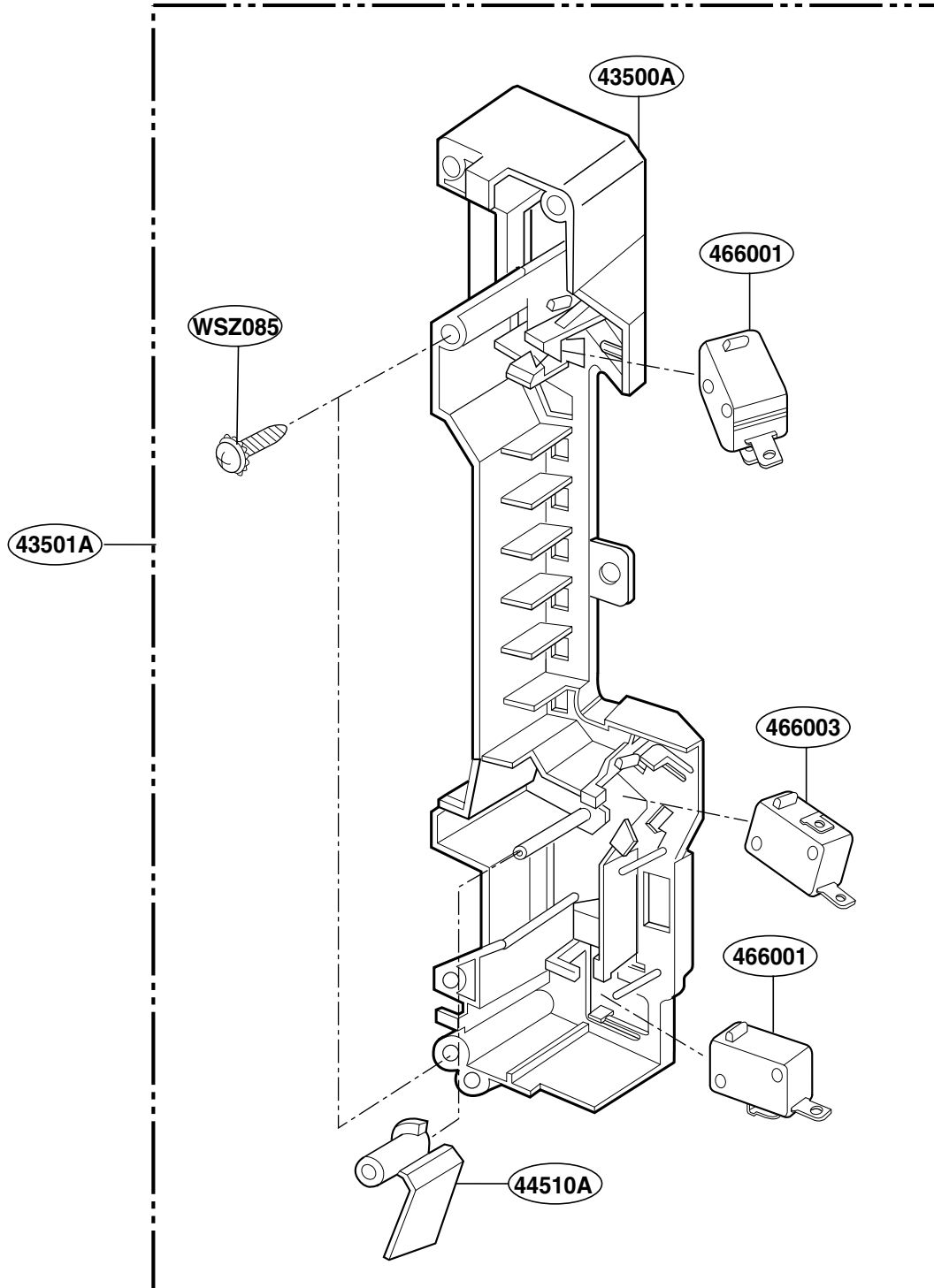

INTERIOR PARTS (I)

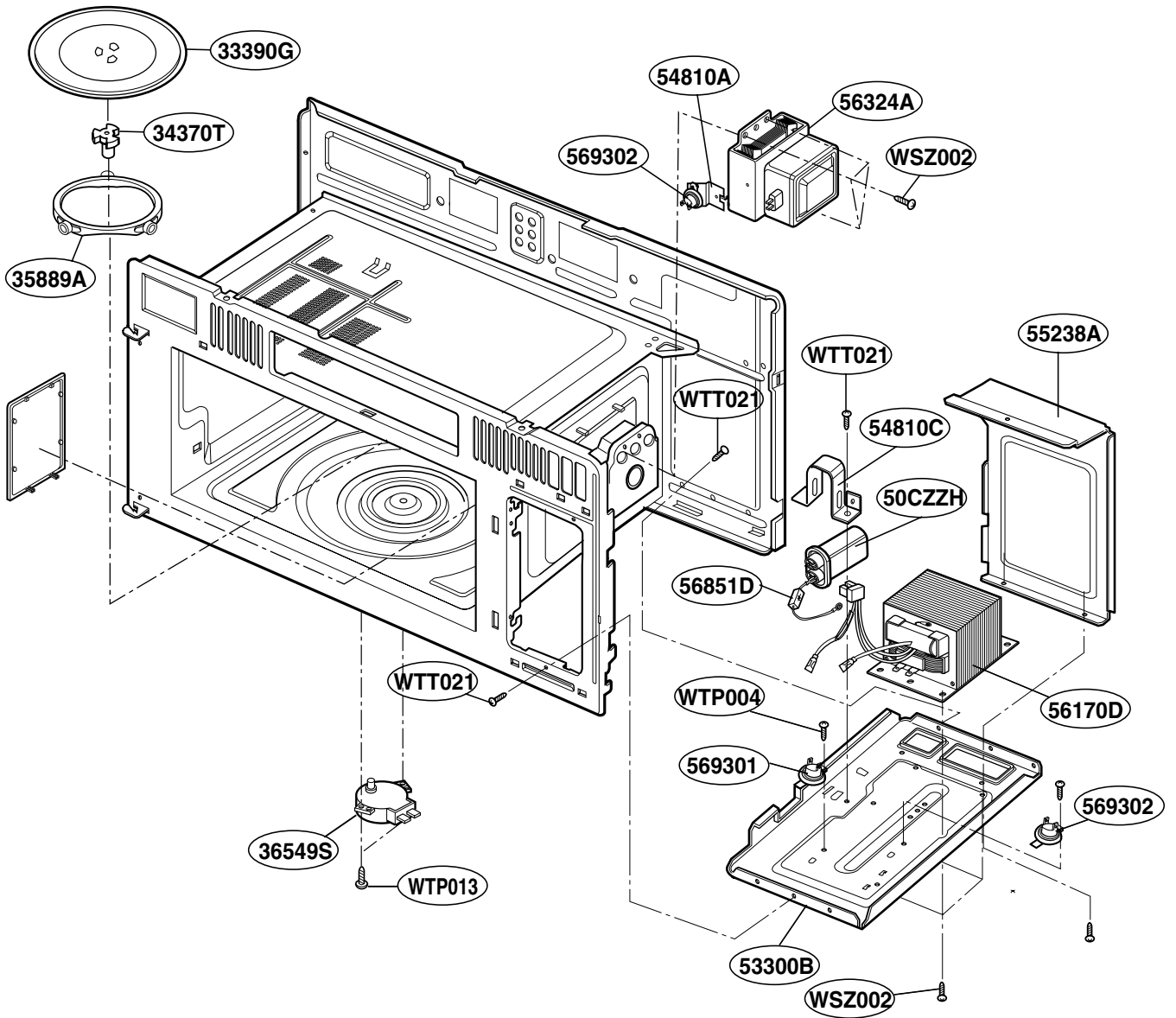

INTERIOR PARTS (II - I)

Model: JVM1631WH 003
JVM1631BH 003
JVM1631CH 003
JVM1631WJ 01 / 02
JVM1631BJ 01 / 02
JVM1631CJ 01 / 02

Check the rating label of **Model** and order SVC parts according to the **Model No.**

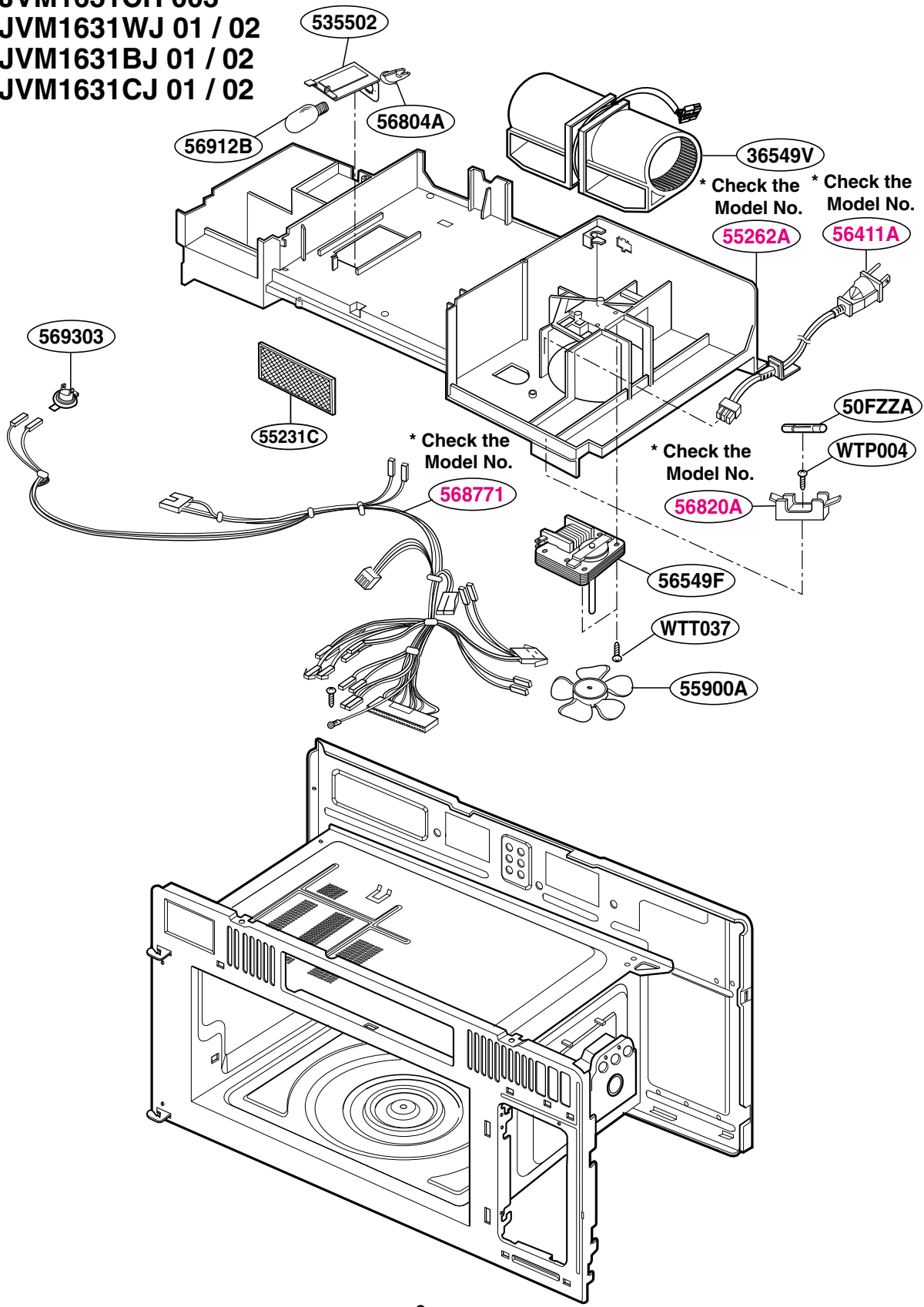

INTERIOR PARTS (II - II)

Model: JVM1631WJ 03
JVM1631BJ 03
JVM1631CJ 03

Check the rating label of **Model** and order SVC parts according to the **Model No.**

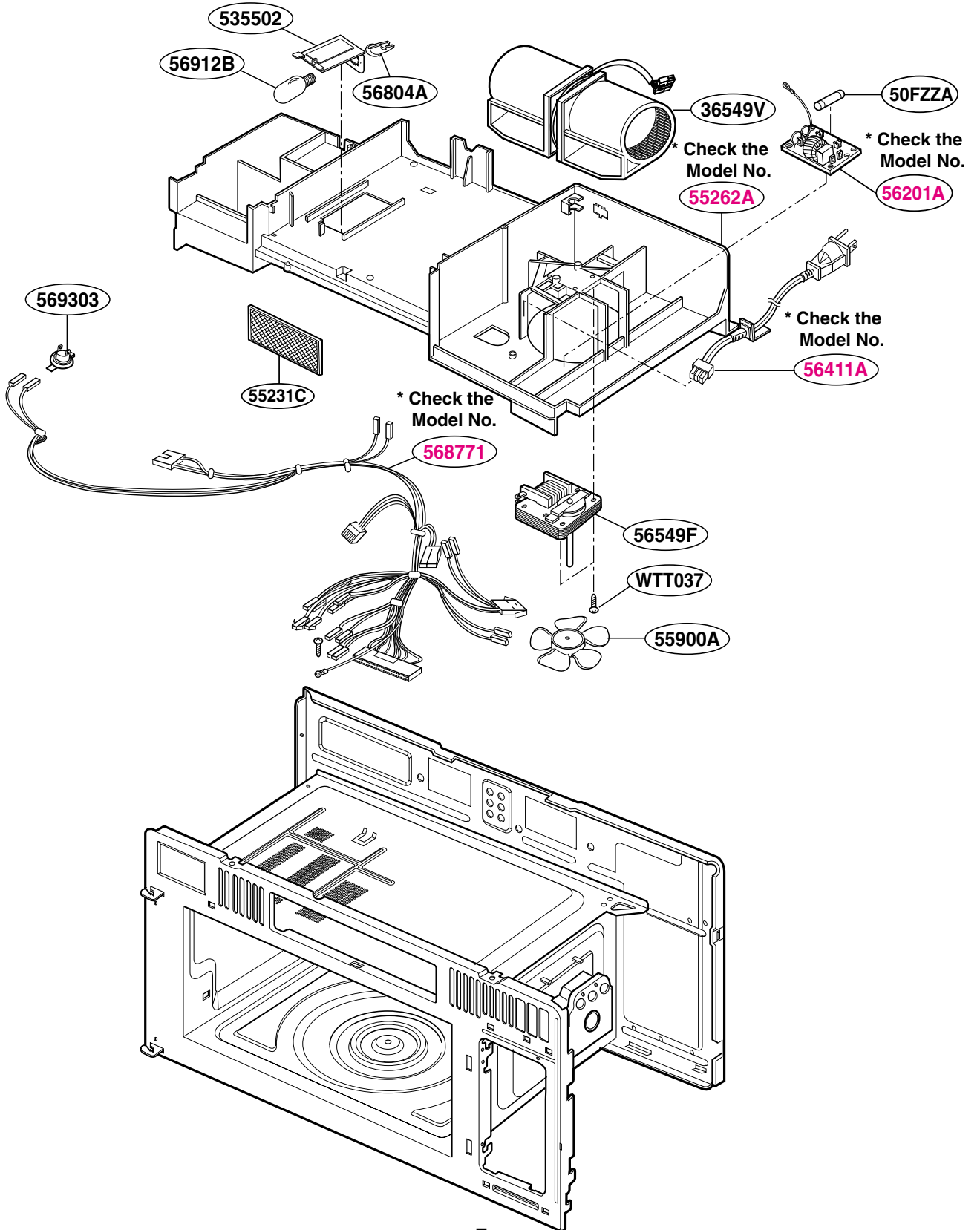

INSTALLATION PARTS

