

This Owner's Manual is provided and hosted by [Appliance Factory Parts](#).



# GE JVM1665SN1SS Owner's Manual

[Shop genuine replacement parts for GE  
JVM1665SN1SS](#)



[Find Your GE Microwave Parts - Select From 3055 Models](#)

----- Manual continues below -----

# EXPLODED VIEW

## INTRODUCTION

MODEL: JVM1665DNBB  
JVM1665DNWW

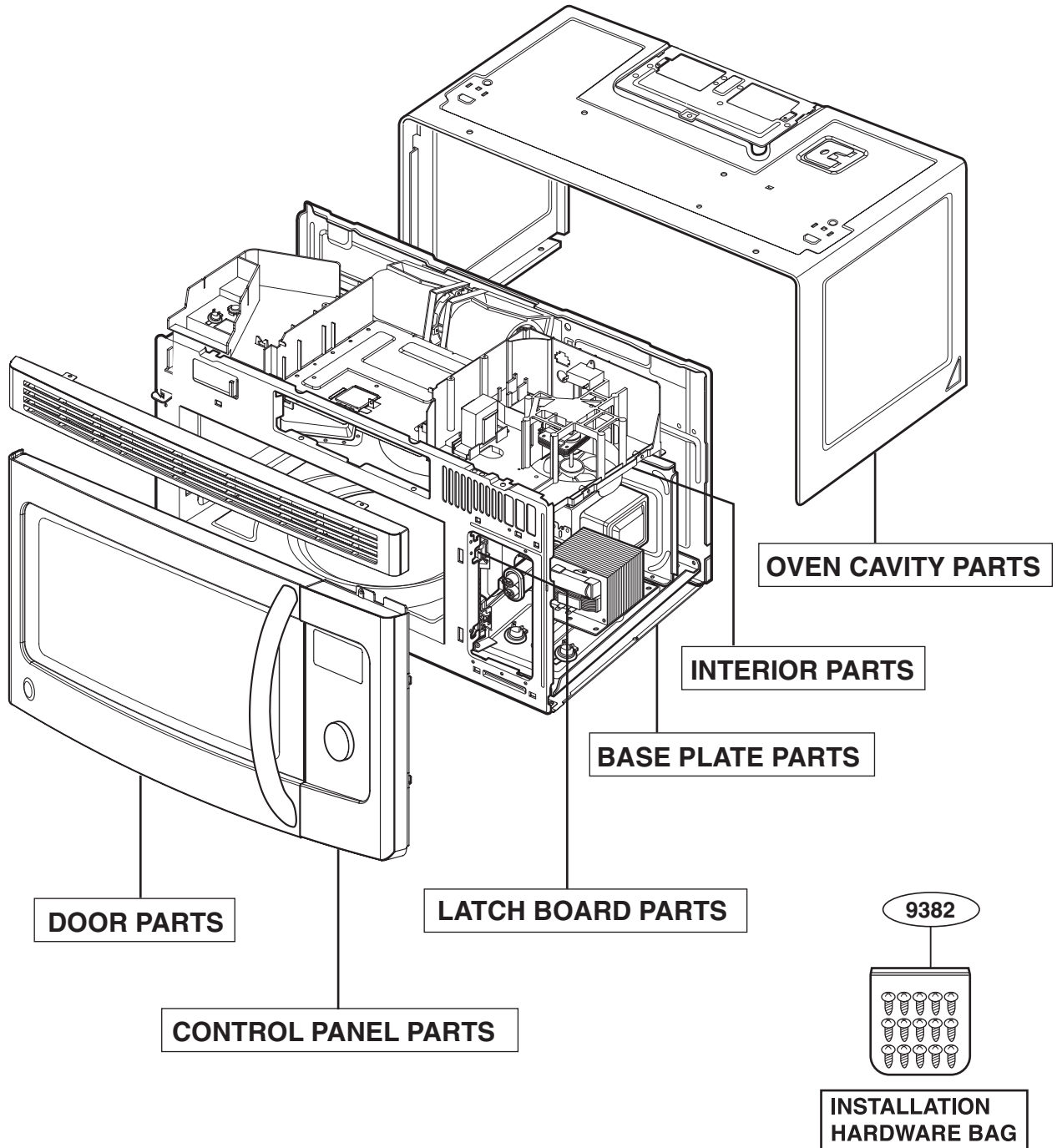

# DOOR PARTS

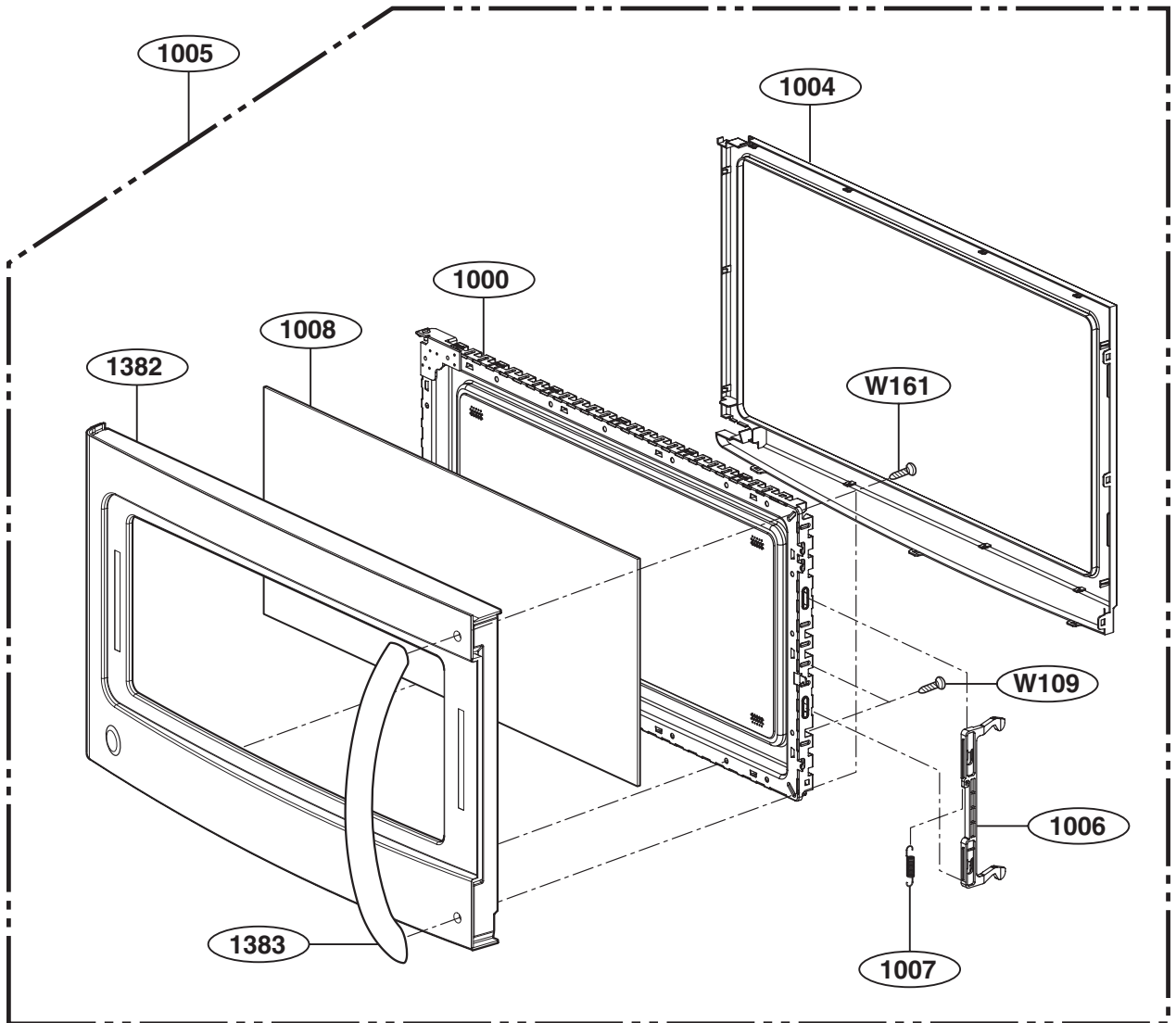

# CONTROLLER PARTS

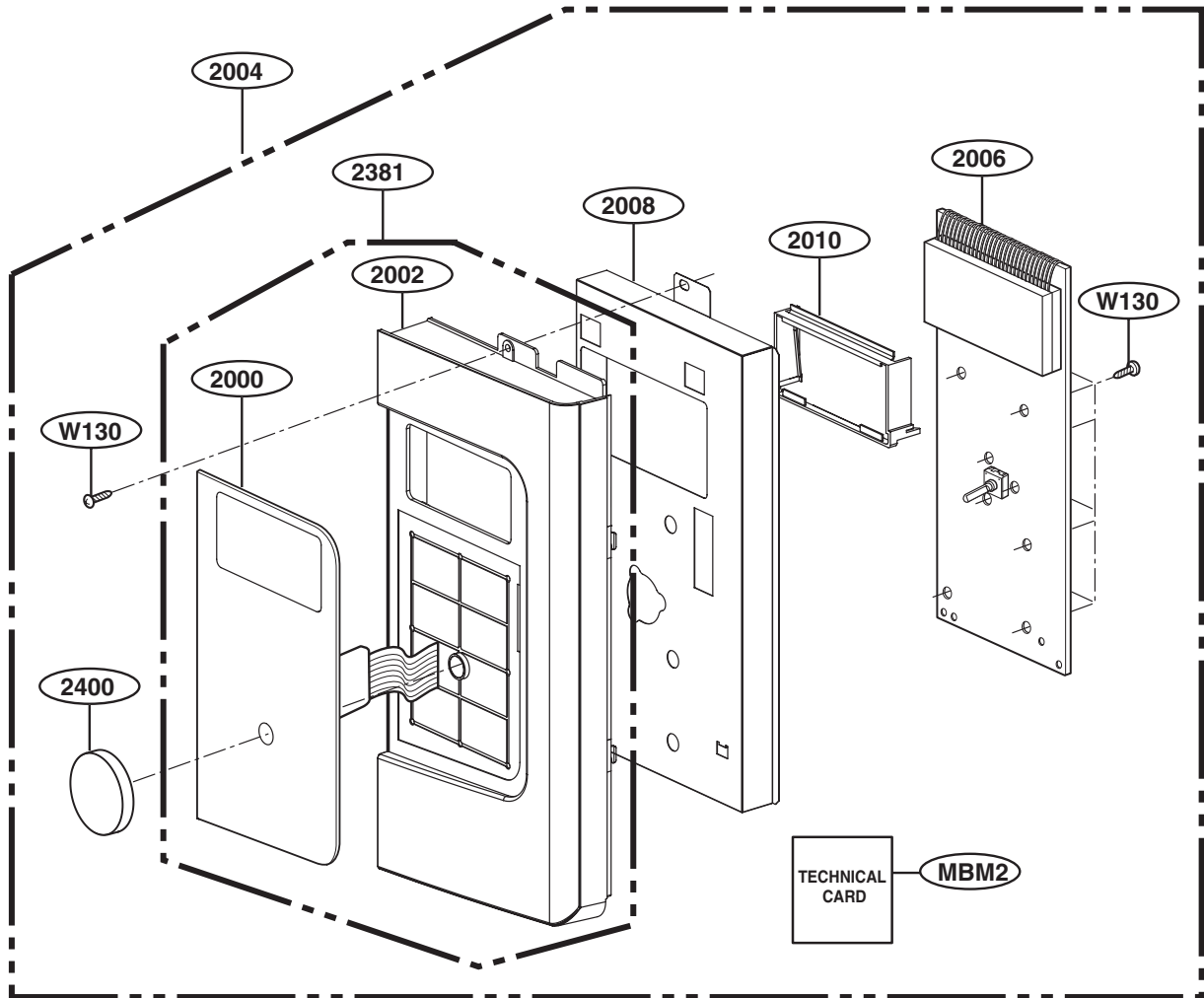

# OVEN CAVITY PARTS

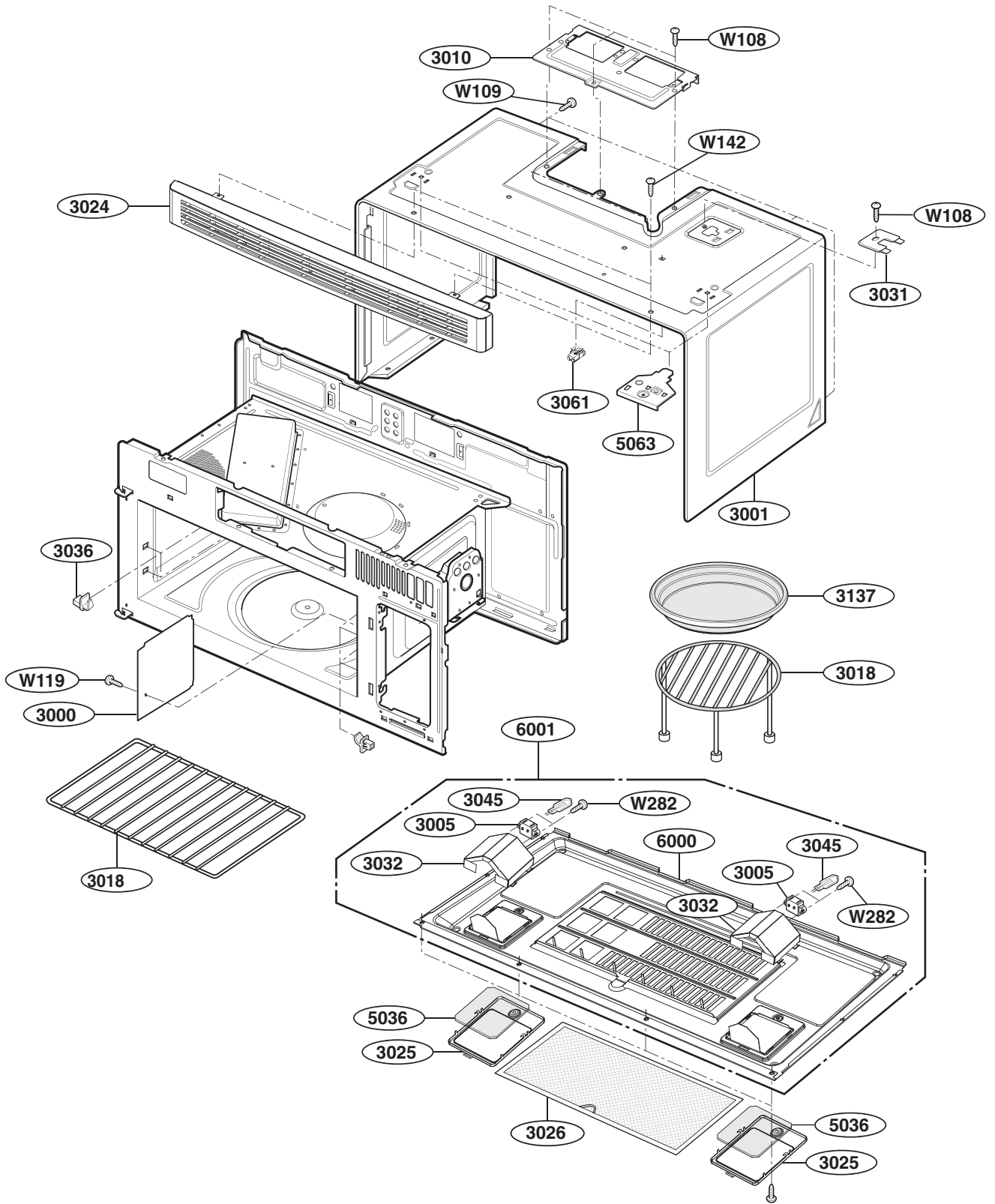

# LATCH BOARD PARTS

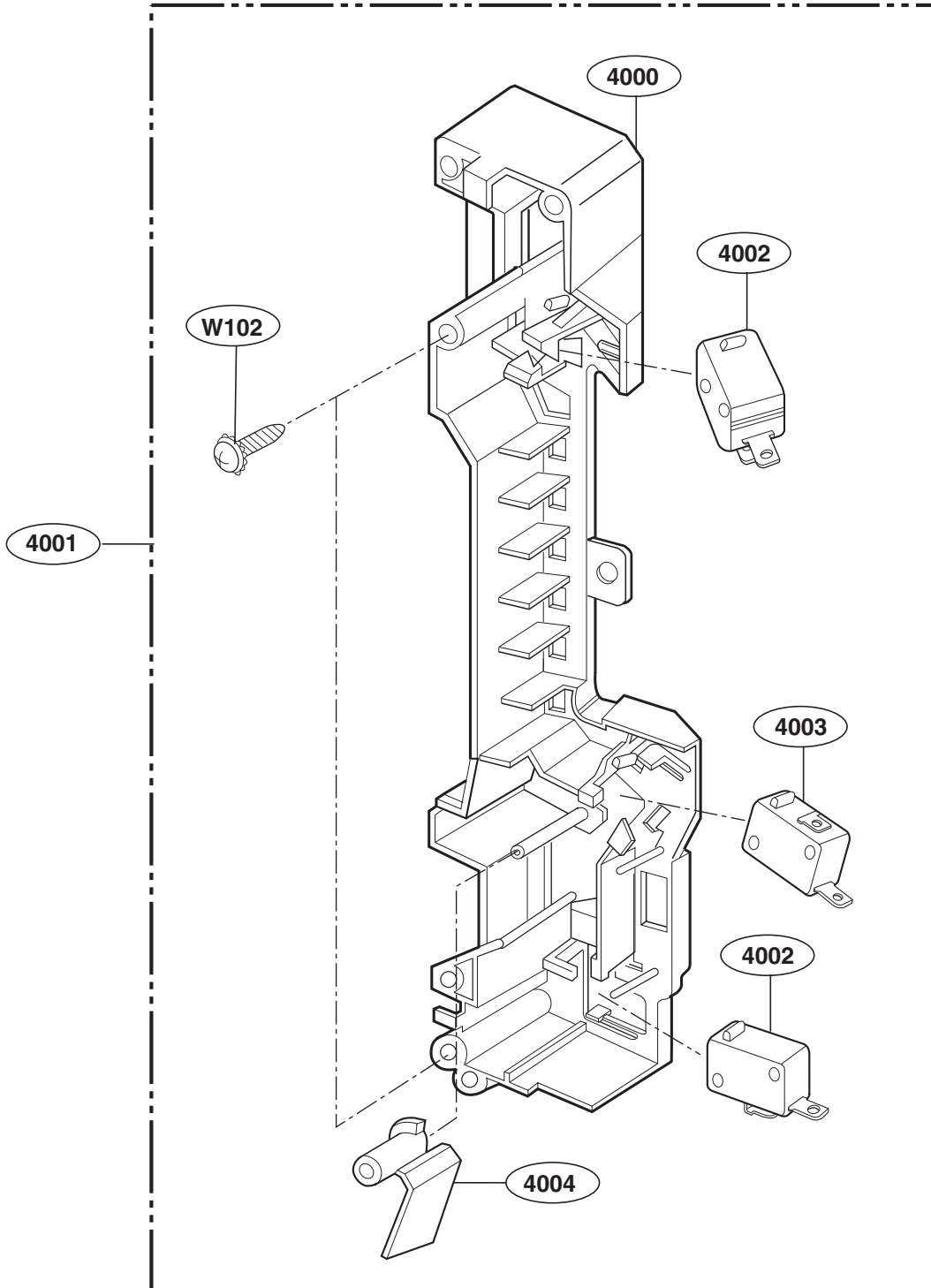

# INTERIOR PARTS (I)

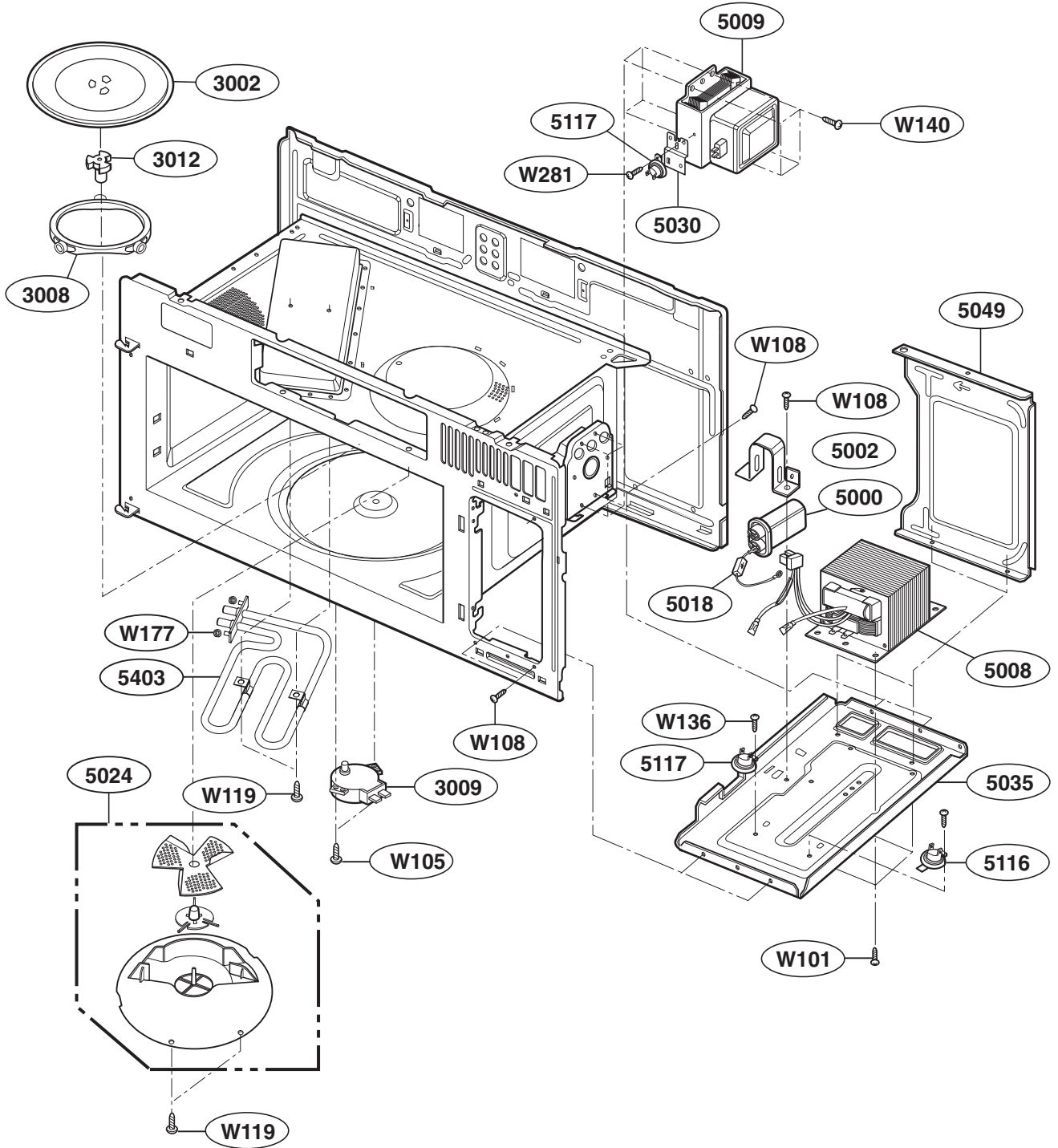

# INTERIOR PARTS (II)

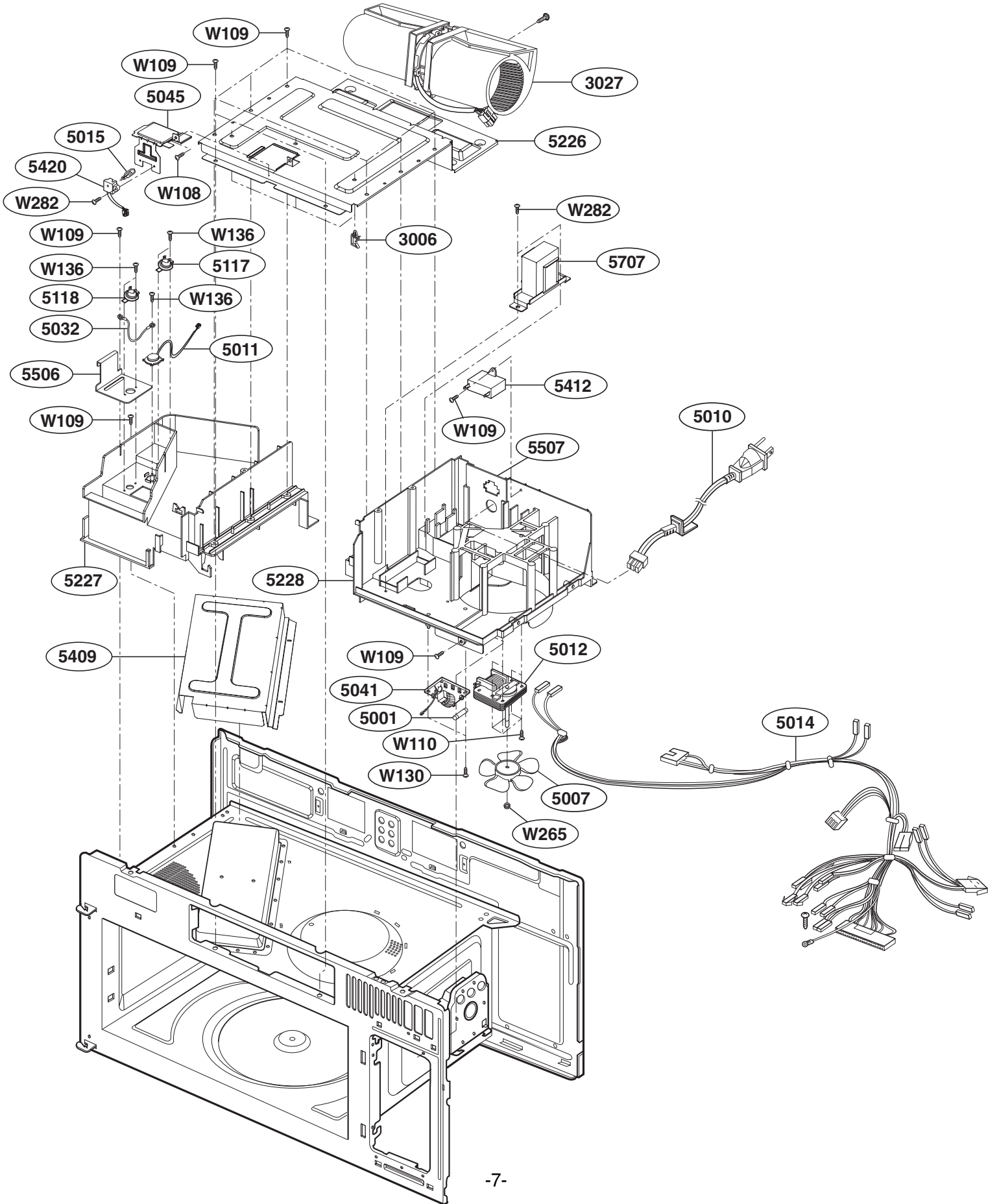

# INSTALLATION PARTS

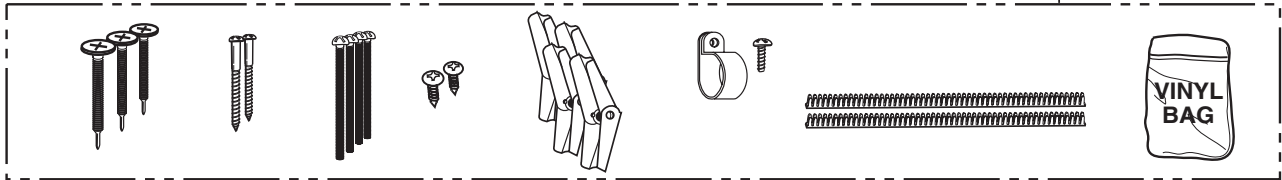
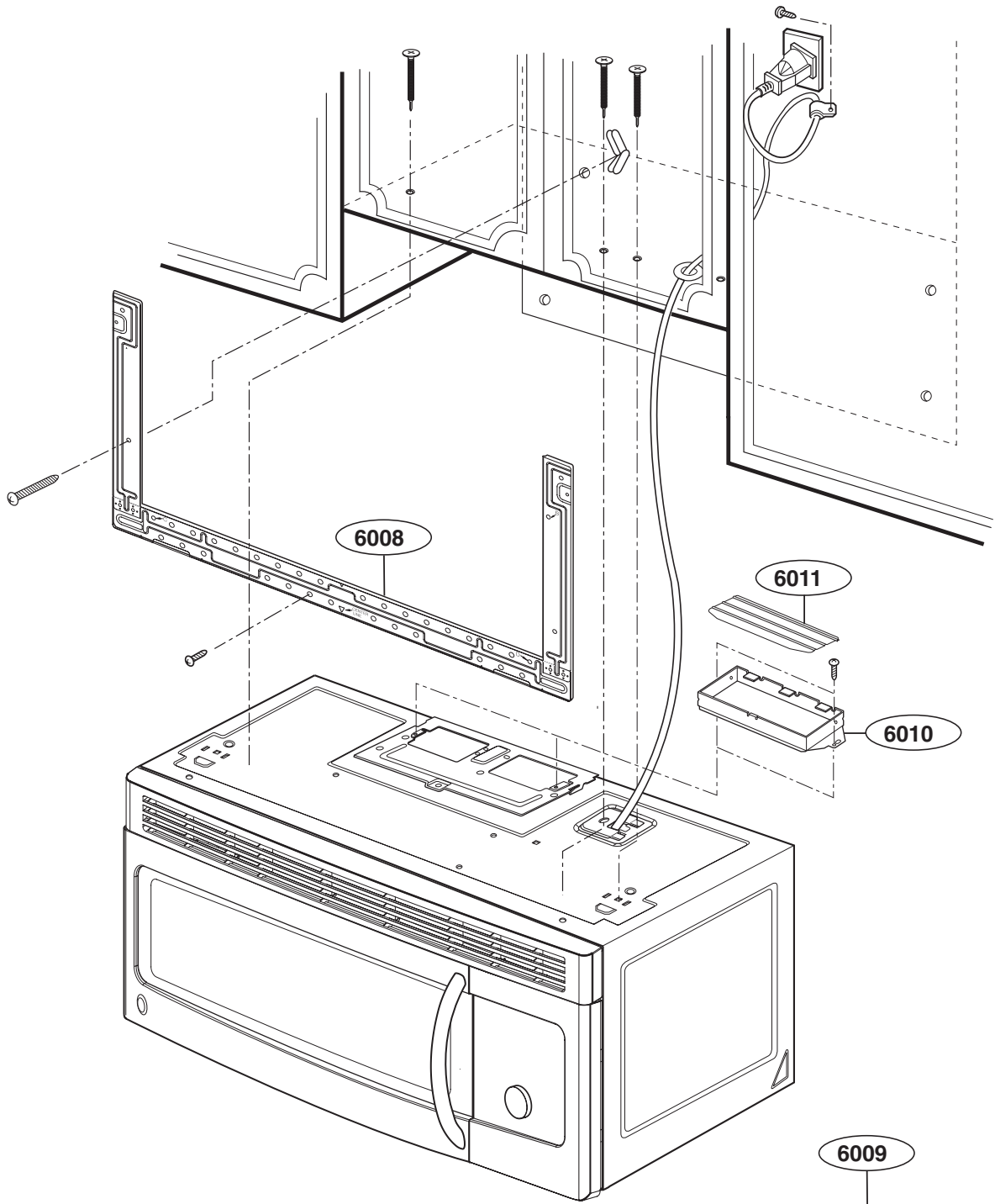

- OWNERS MANUAL — MFL1
- INSTALLATION MANUAL — MFL3
- COOKING GUIDE LABEL — MEZ1
- WALL TEMPLATE — MBM5
- UPPER TEMPLATE — MBM4