

This Owner's Manual is provided and hosted by [Appliance Factory Parts](#).



GE SCA1000HCC02 Owner's Manual

[Shop genuine replacement parts for GE
SCA1000HCC02](#)



[Find Your GE Microwave Parts - Select From 3055 Models](#)

----- Manual continues below -----

Model: SCA1000HBB
SCA1000HWW
SCA1000HCC
SCA1001HSS
SCA1001KSS

DOOR PARTS

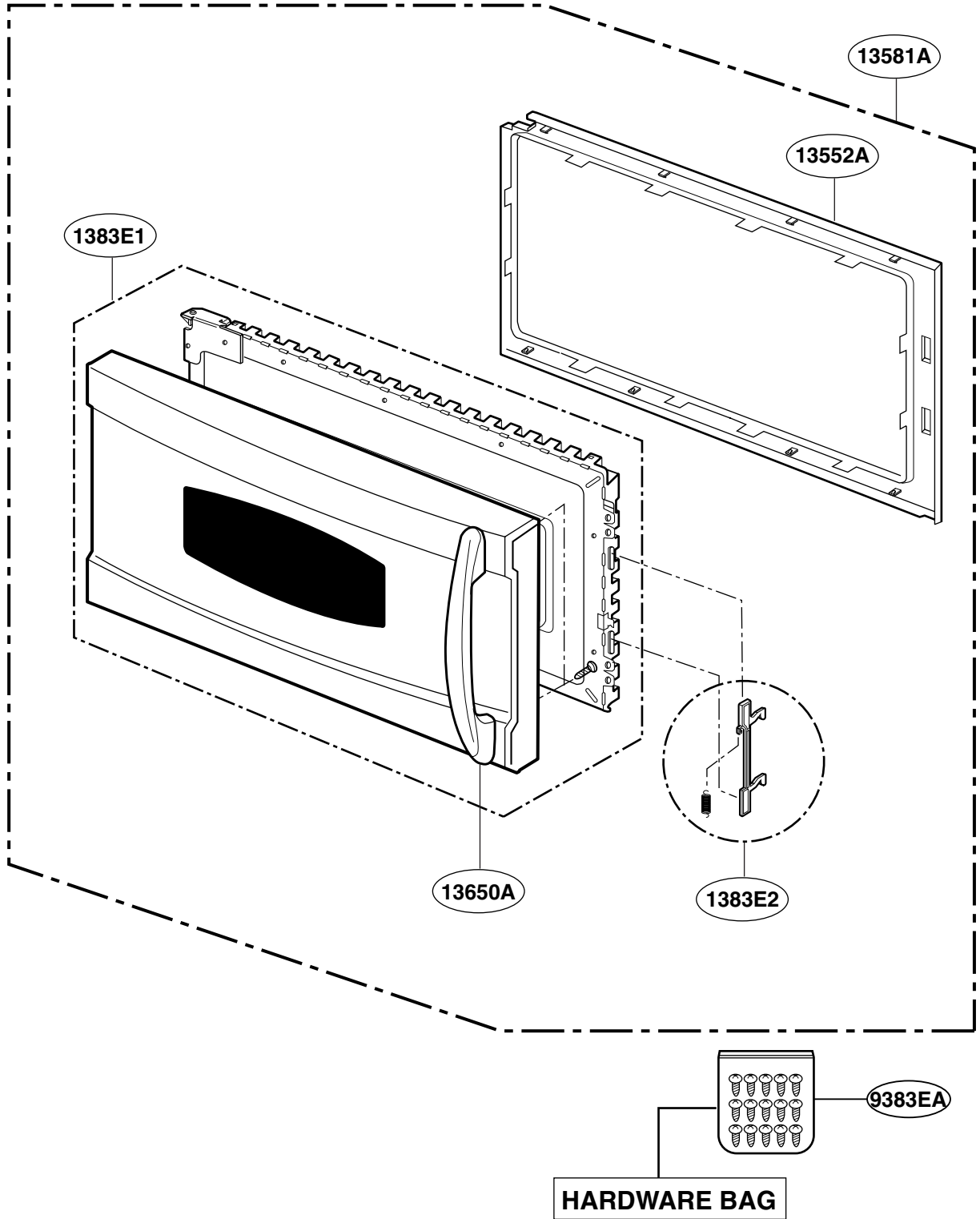

Model: SCA1000HBB
SCA1000HWW
SCA1000HCC
SCA1001HSS
SCA1001KSS

CONTROLLER PARTS

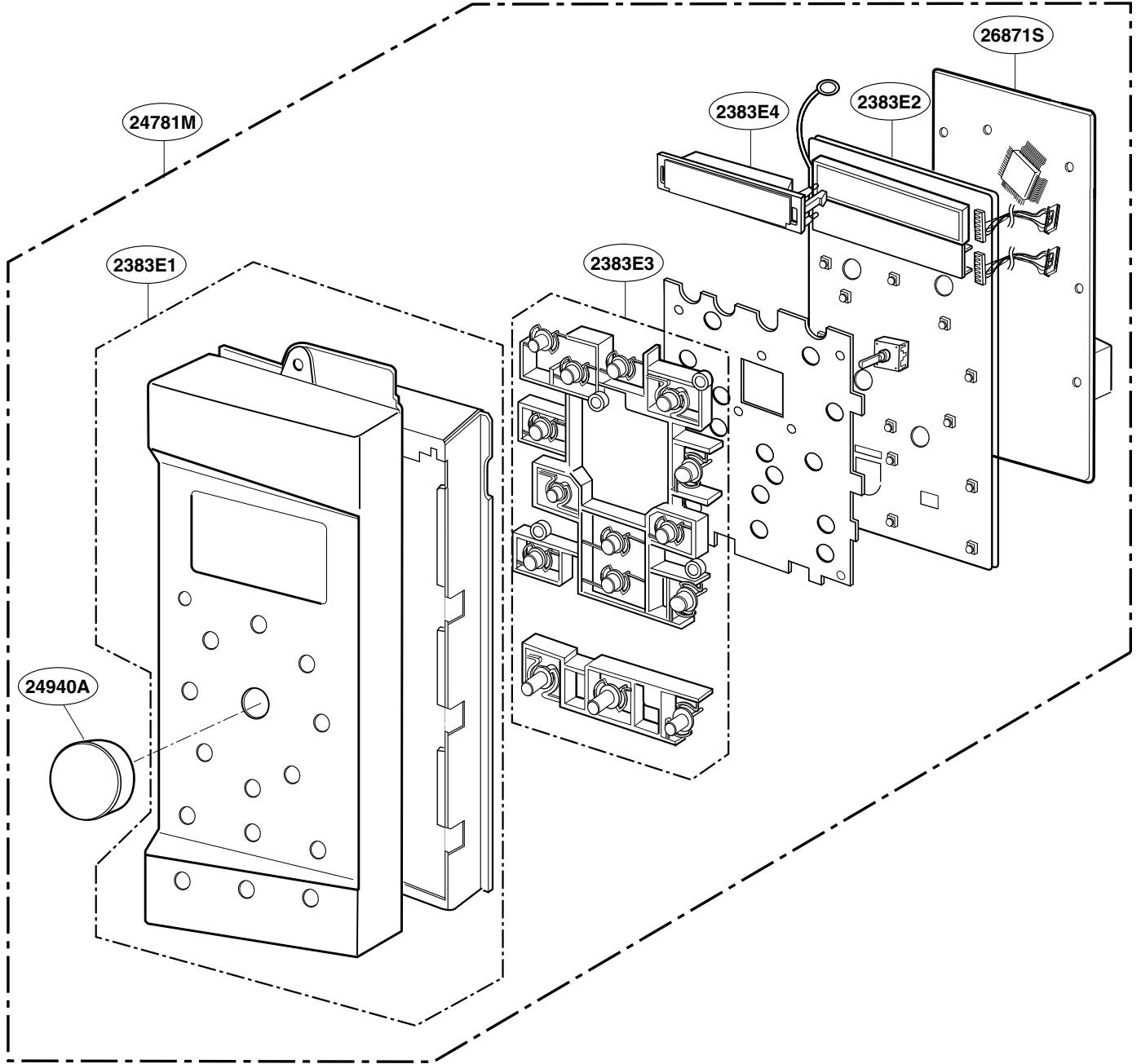

Model: SCA1000HBB
SCA1000HWW
SCA1000HCC
SCA1001HSS
SCA1001KSS

OVEN CAVITY PARTS

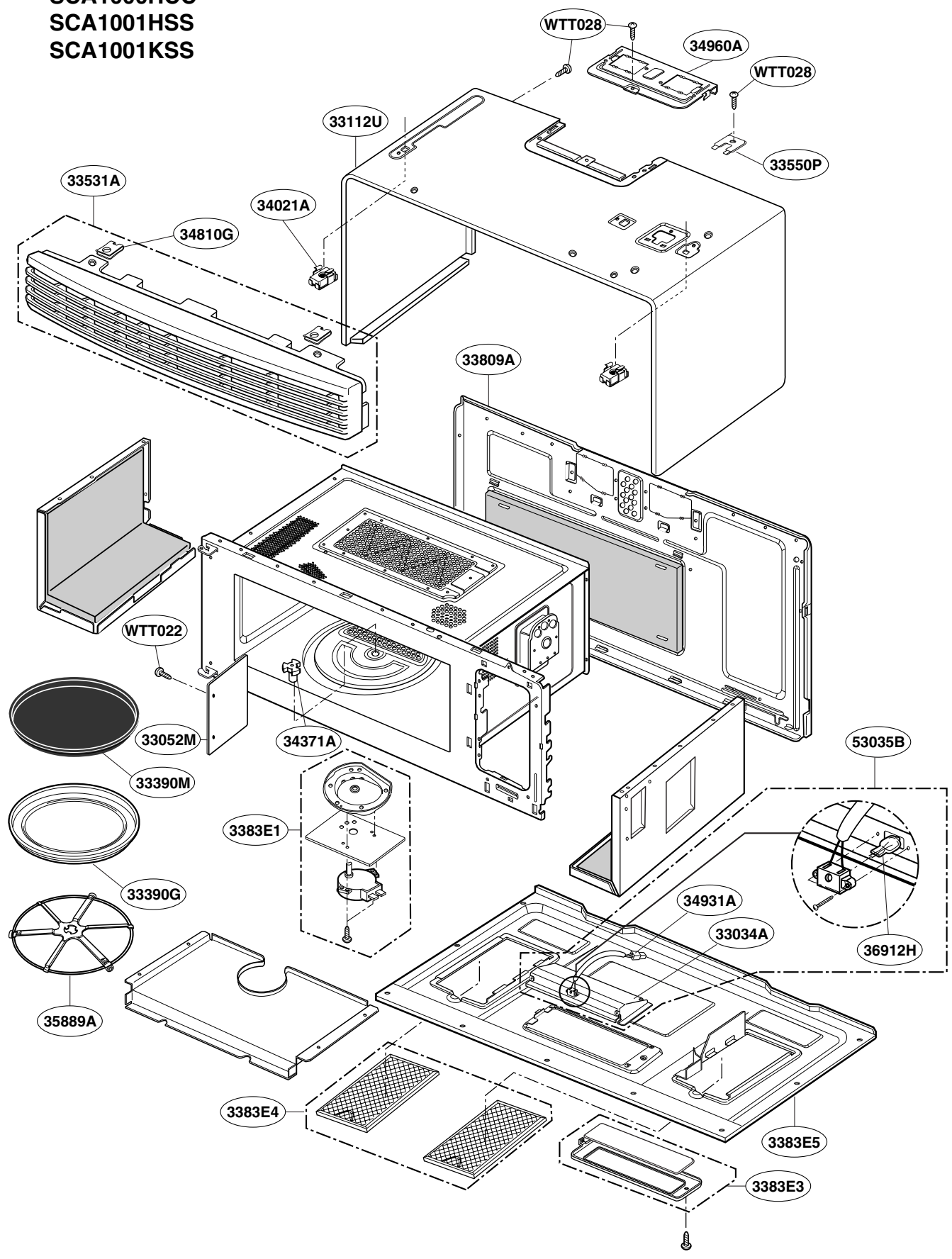

Model: SCA1000HBB
SCA1000HWW
SCA1000HCC
SCA1001HSS
SCA1001KSS

LATCH BOARD PARTS

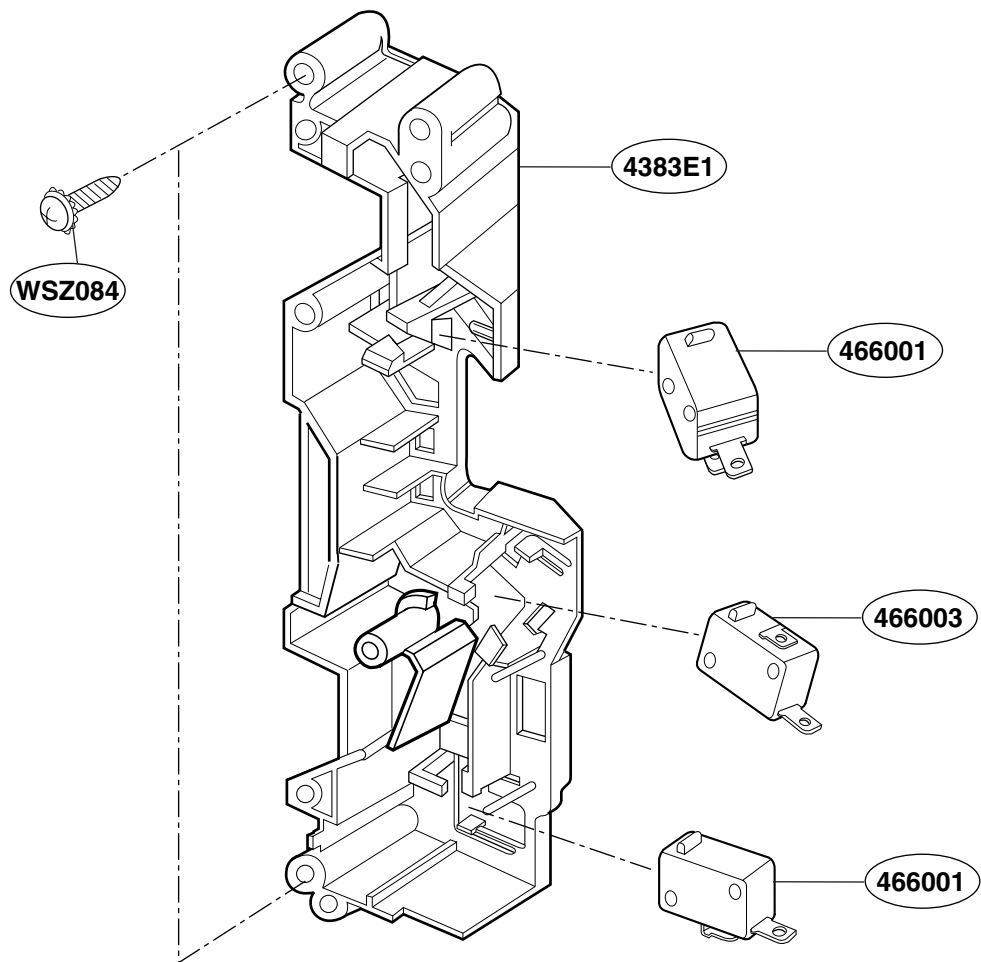

Model: SCA1000HBB 01
 SCA1000HCC 01
 SCA1000HWW 01
 SCA1001HSS 01
 SCA1000HBB 02
 SCA1000HCC 02
 SCA1000HWW 02
 SCA1001HSS 02

INTERIOR PARTS (I-I)

Check the rating label of Model and order SVC parts according to the Model No.

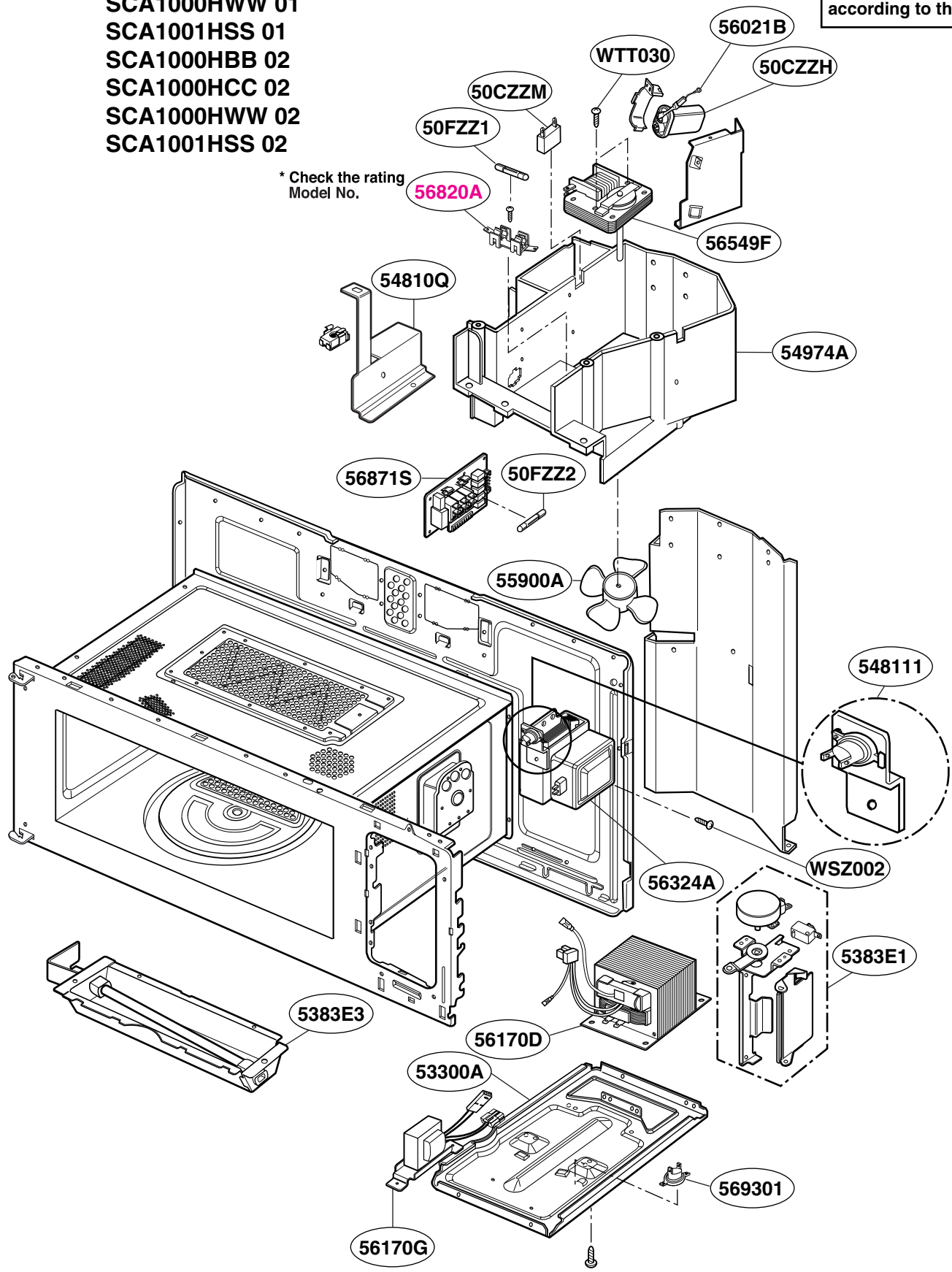

* Check the rating Model No.

Model: SCA1000HBB 03
 SCA1000HCC 03
 SCA1000HWW 03
 SCA1001HSS 03
 SCA1001KSS 01

INTERIOR PARTS (I-II)

Check the rating label of Model and order SVC parts according to the Model No.

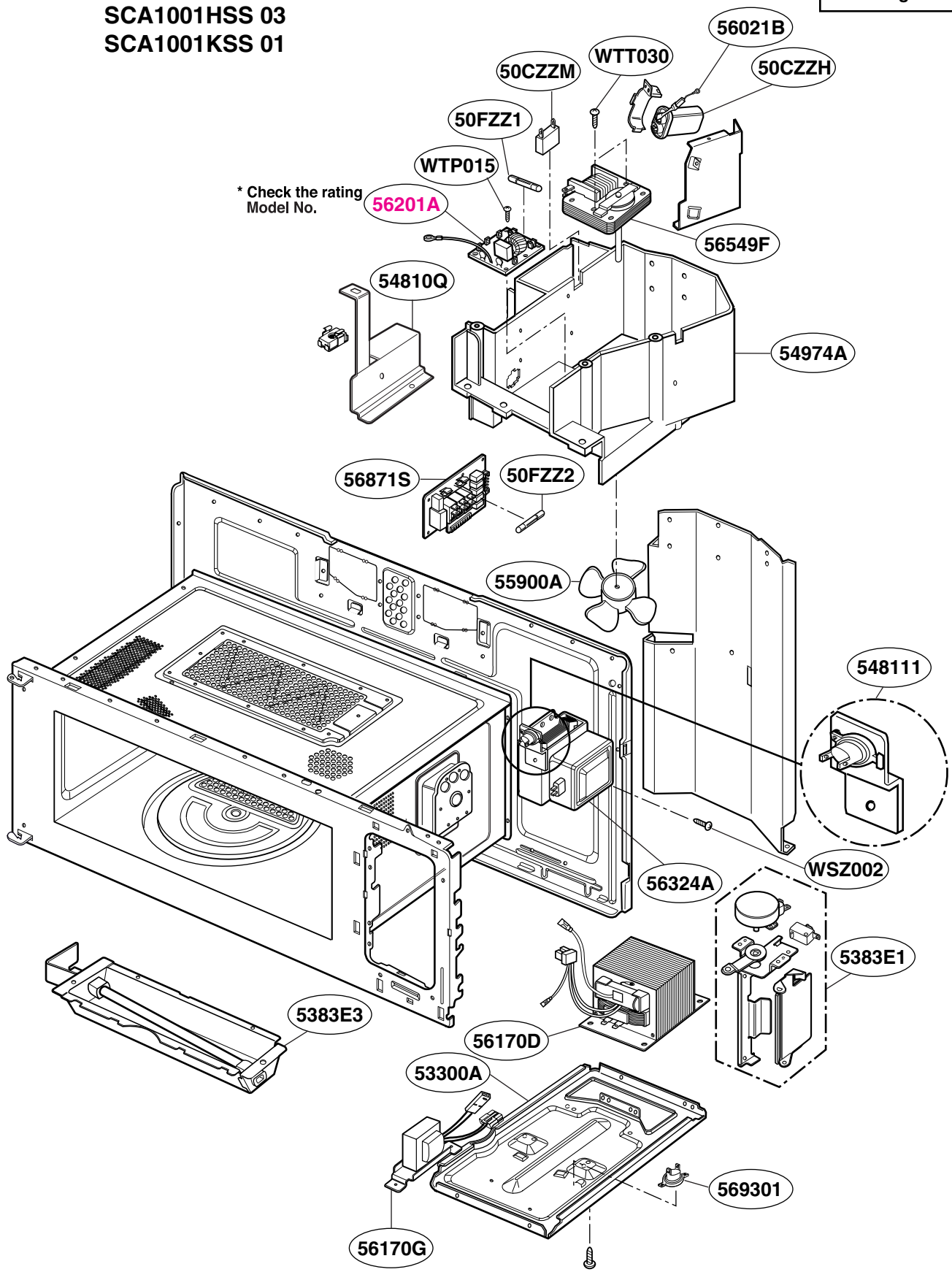

Model: SCA1000HBB 04
SCA1000HCC 04
SCA1000HWW 04
SCA1001KSS 02

INTERIOR PARTS (I-III)

Check the rating label of Model and order SVC parts according to the Model No.

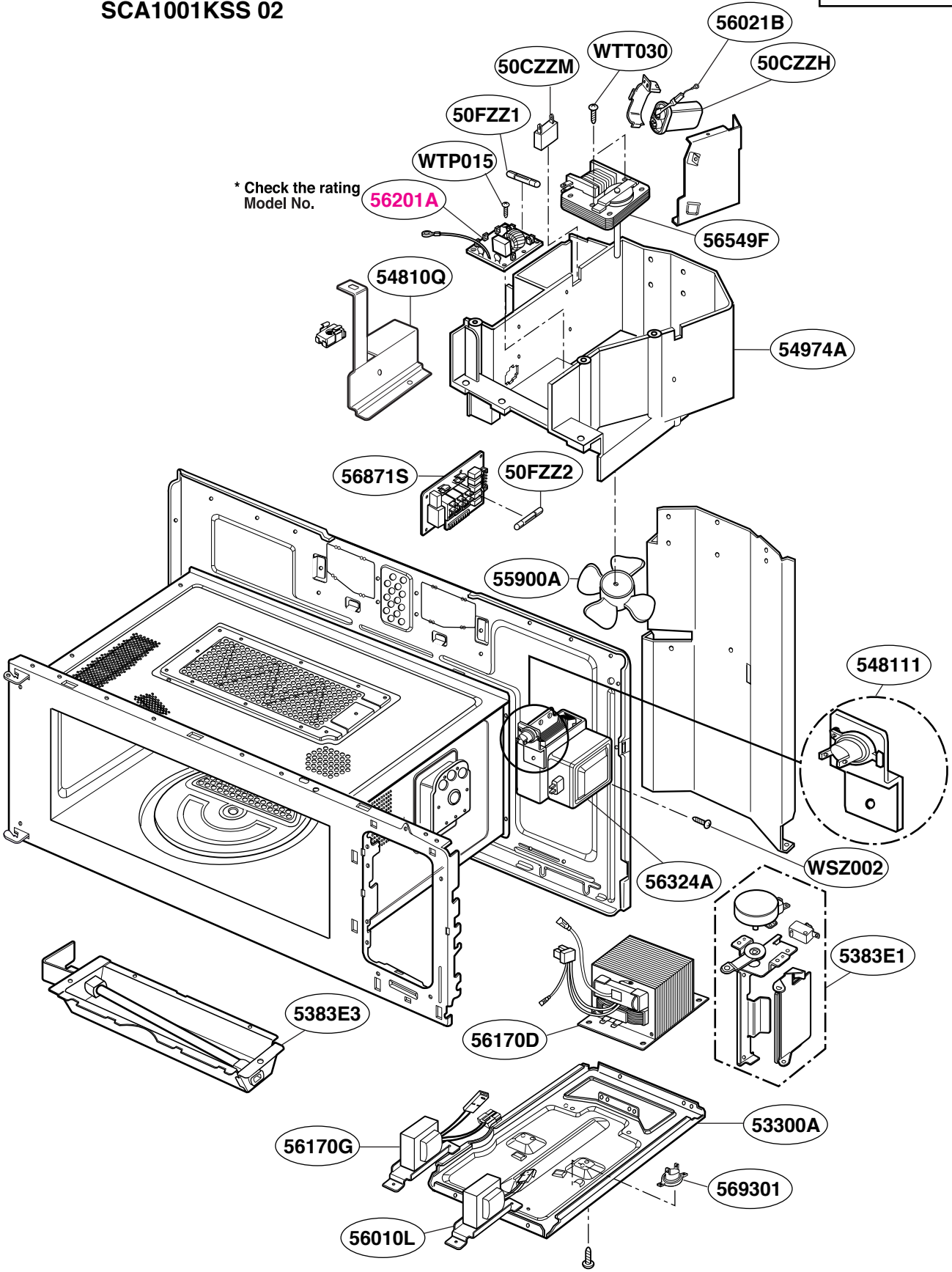

Model: SCA1000HBB 01
SCA1000HCC 01
SCA1000HWW 01
SCA1001HSS 01

INTERIOR PARTS (II - I)

Check the rating label of Model and order SVC parts according to the Model No.

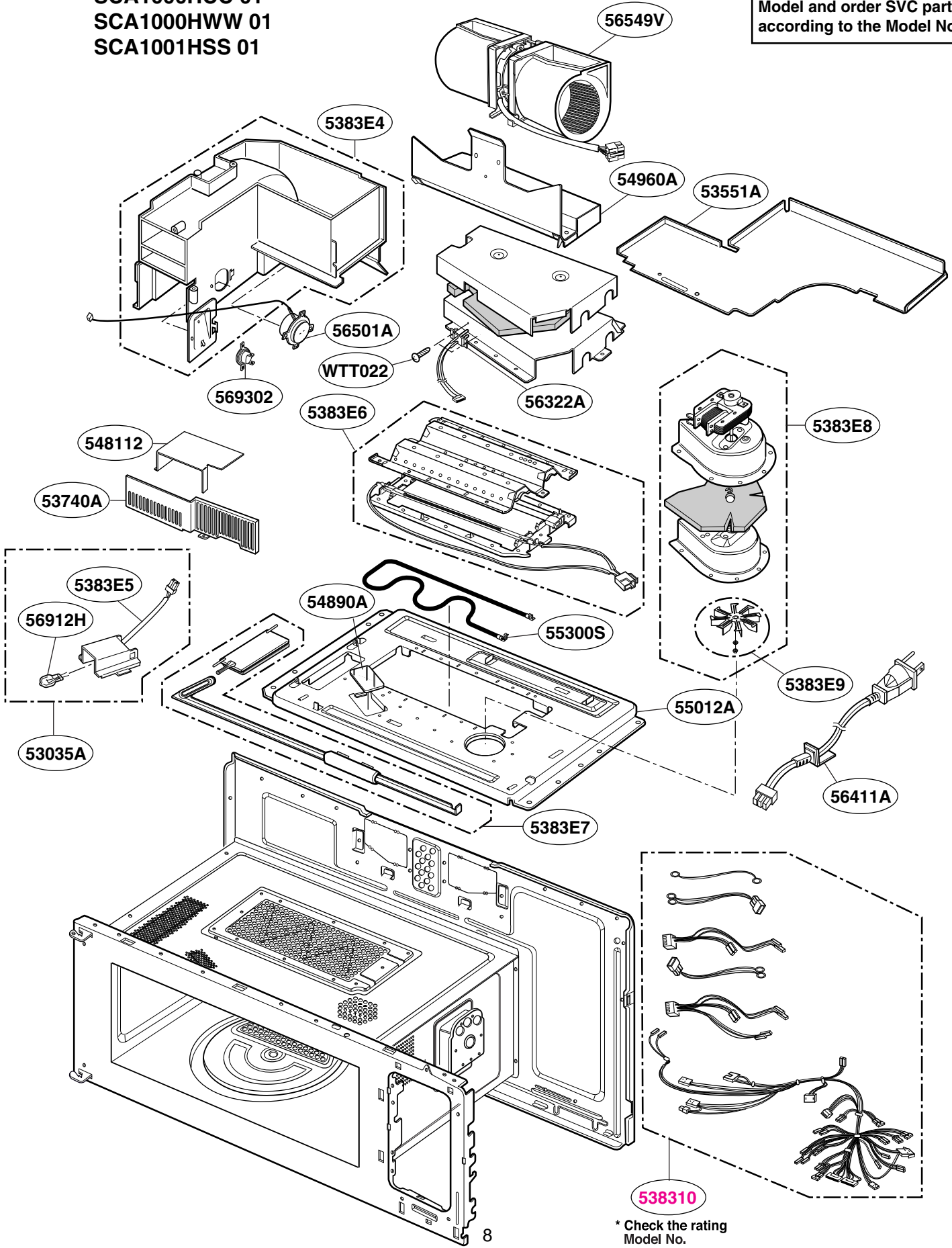

* Check the rating Model No.

Model: SCA1000HBB 02
 SCA1000HCC 02
 SCA1000HWW 02
 SCA1001HSS 02
 SCA1000HBB 03
 SCA1000HCC 03
 SCA1000HWW 03
 SCA1001HSS 03
 SCA1001KSS 01

INTERIOR PARTS (II - II)

Check the rating label of Model and order SVC parts according to the Model No.

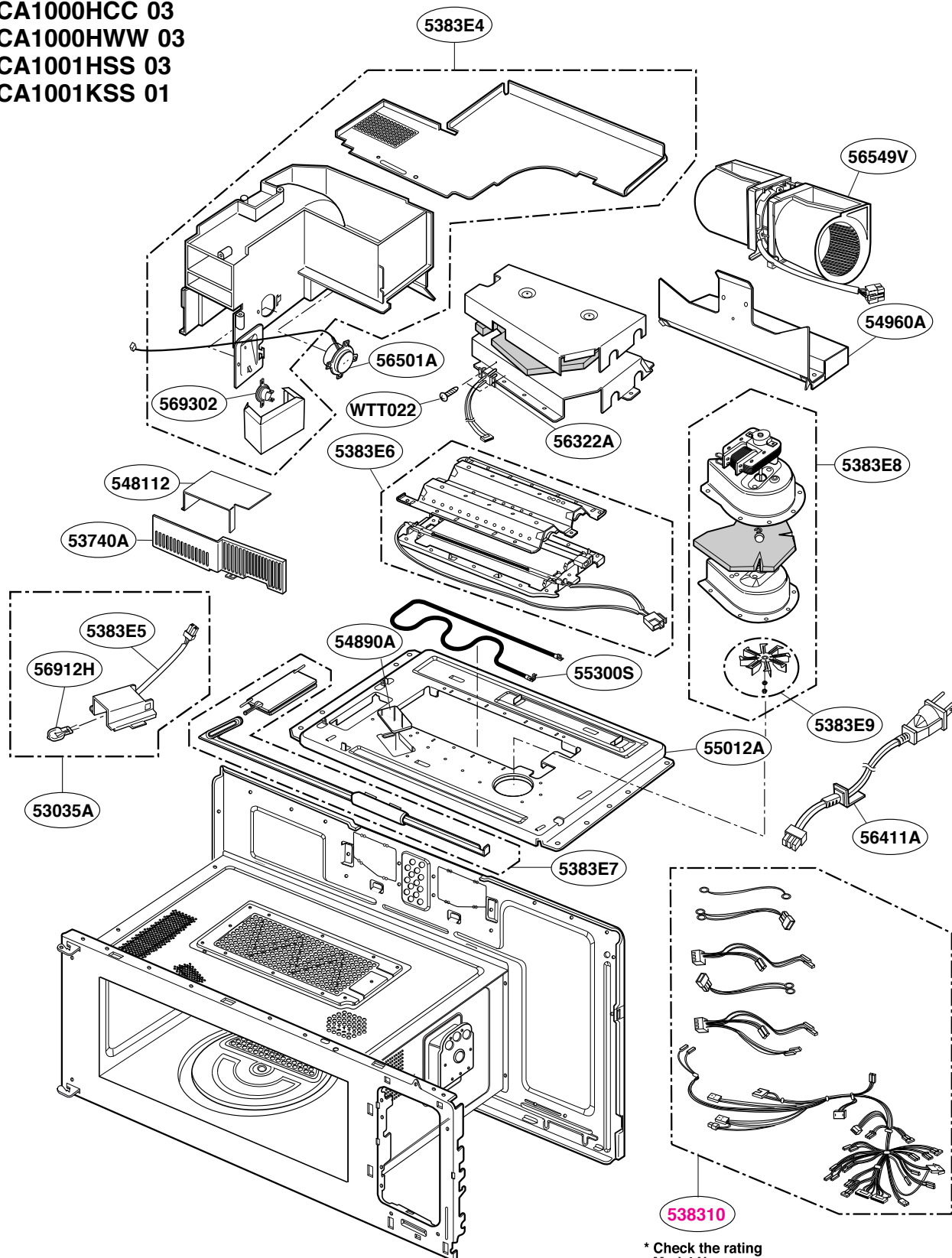

* Check the rating Model No.

Model: SCA1000HBB 04
SCA1000HCC 04
SCA1000HWW 04
SCA1001KSS 02

INTERIOR PARTS (II - III)

Check the rating label of Model and order SVC parts according to the Model No.

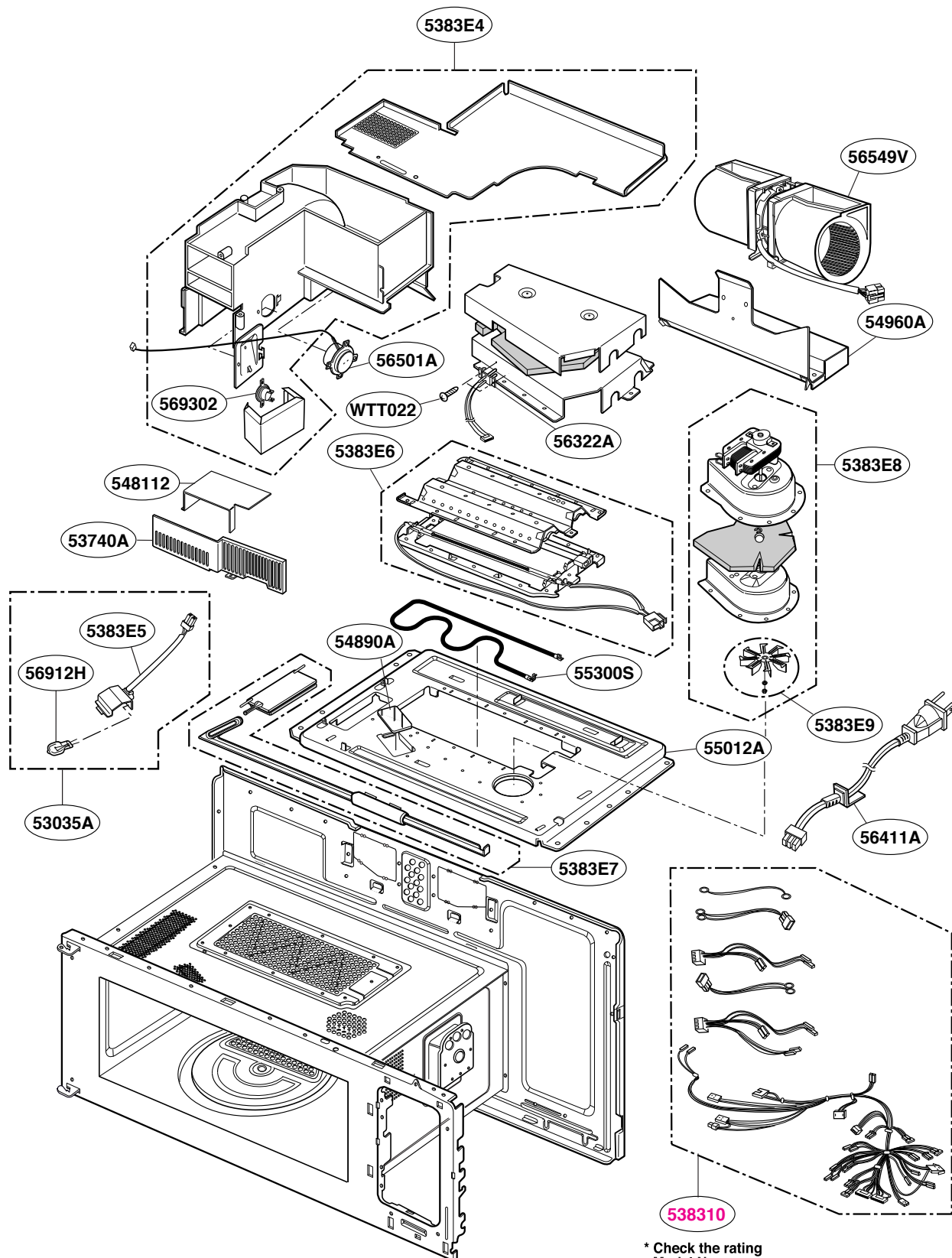

* Check the rating Model No.

Model: SCA1000HBB
SCA1000HWW
SCA1000HCC
SCA1001HSS
SCA1001KSS

INSTALLATION PARTS

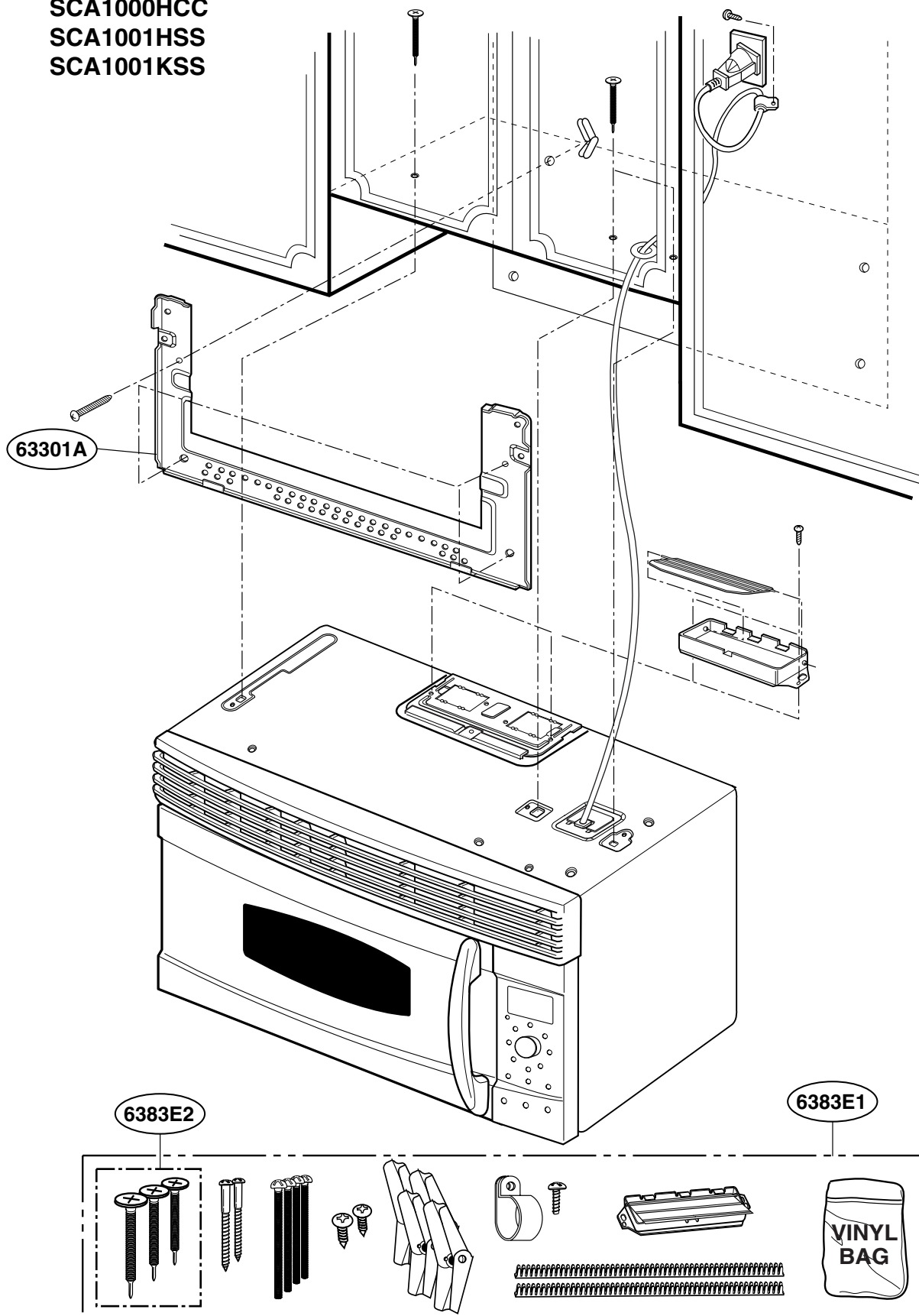

Part Reference list

Rev.5 Mar 13, 2006
 Rev.4 Feb 18, 2005
 Rev.3 Nov 29, 2004
 Rev.2 Nov 05, 2003
 Rev.1 Sep 17, 2003

For Model : SCA1000HBB

LOC.NO	OLD DESCRIPTION	NEW DESCRIPTION	DIFFERENCE CHART				SVC	QTY	ALTERNATIVEP ART NO.	REMARKS
			SCA1000HBB/01	SCA1000HBB/02	SCA1000HBB/03	SCA1000HBB/04				
*01	MANUAL,OWNERS	Manual,Owners	3828W5A3717	3828W5A4680	3828W5A4680	MFL30039301	R	1		Change
*03	COOK BOOK	Book,Cook	3878W5A0034				R	1		
*04	MANUAL,INSTALLATION	Manual,Installation	3828W5U0128				R	1		
*05-1	LABEL,COOKING GUIDE	Label,Cooking Guide	3850W5D002A				R	1		
*05-2	LABEL,COOKING GUIDE	Label,Cooking Guide	3850W5D002B				R	1		
*06-1	TEMPLATE	Card,Template	4922W5A022A				R	1		
*06-2	TEMPLATE	Card,Template	4922W5A024A				R	1		
*07	CARD,TECHNICAL	Card,Technical	3840W5T098E	3840W5T098E	3840W5T0036	MBM30035001	R	1		Change
*10	BOX,YELLOW	Box	3890W3Y735A				R	1		
13552A	CHOKE COVER	Cover,Choke	3552W1A044A	3552W1A044B	3552W1A044B	3552W1A044B	R	1		Change
13581A	DOOR ASSEMBLY	Door Assembly	3581W0A095B				R	1		
13650A	SERVICE PARTS(HANDLE ASSY)	Parts Assembly	383EW1A075B				R	1		
1383E1	SERVICE PARTS(DOOR GLOSS SUB ASSY)	Parts Assembly	383EW1A074B				R	1		
1383E2	SERVICE PARTS(LATCH+SPRING)	Parts Assembly	383EW2A001A				R	1		
2383E1	SERVICE PARTS(CONTROL PANEL ASSY)	Parts Assembly	383EW1A015L				R	1		
2383E2	SERVICE PARTS(KEY PCB ASSY)	Parts Assembly	383EW1A020C				R	1		
2383E3	SERVICE PARTS(BUTTON ASSY)	Parts Assembly	383EW1A019L				R	1		
2383E4	SERVICE PARTS(LED HOLDER ASSY)	Parts Assembly	383EW1A037A				R	1		
24781M	CONTROLLER ASSEMBLY,MICOM	Controller Assembly,Keypad	4781W1M352B				R	1		
24940A	KNOB	Knob	4940W3A019B				R	1		
26871S	PWB(PCB) ASSEMBLY,SUB	PCB Assembly,Sub	6871W1S005D				R	1		
33034A	REFLECTOR	Reflector	3034W1A008A	3034W1A008A	3034W1A008A	3034W2A006A	R	1		Change
33052M	CANOPY,MICA	Cover,Insulator	3052W3M025A				R	1		
33112U	OUT CASE,U-BENDING	Case,U Bending	3112W0U043B				R	1		
33390G	TRAY,GLASS	Tray,Glass	1B71961A				R	1	1B71961E	
33390M	TRAY,METAL	Tray,Metal	3390W2M005B				R	1		
33531A	GRILLE ASSEMBLY	Grille Assembly	3531W1A017F				R	1		
33550P	COVER,POWER CORD	Cover,Power Cord	3550W3A084A				R	1		
33809A	COVER ASSEMBLY,BACK	Cover Assembly,Rear	3809W0A002C				R	1		
3383E1	SERVICE PARTS(T/T MOTOR ASSY)	Parts Assembly	383EW1A022A	383EW1A022A	383EW1A022C	383EW1A022C	R	1		Change
3383E3	SERVICE PARTS(COOKTOP GLASS ASSY)	Parts Assembly	383EW1A021B				R	1		
3383E4	SERVICE PARTS(GREASE FILTER ASSY)	Parts Assembly	383EW1A023A				R	2		
3383E5	SERVICE PARTS(BASE PLATE ASSY)	Parts Assembly	383EW1A036H	383EW1A036H	383EW1A036H	383EW1A036K	R	1		Change
34021A	HOLDER ASSEMBLY	Holder Assembly	4021W3A001A				R	2		
34371A	SHAFT,TURN TABLE	Shaft,Turntable	4371W1A001A				R	1		
34810G	BRACKET,MISC	Bracket,Idle	4810W3G142A				R	2		
34931A	HOLDER ASSEMBLY	Holder Assembly	4931W1A009G	4931W1A009G	4931W1A009G	4931W3A004B	R	1		Change
34960A	MOUNT	Plate	4960W1A008B				R	1		
35889A	ROTATING RING ASSEMBLY	Turntable Assembly	5889W1A001D	5889W1A001D	5889W1A011A	5889W1A011A	R	1		Change
36912H	LAMP,HALOGEN	Lamp,Halogen	6912A40002A	6912A40002A	6912A40002D	6912W3H001D	R	1		Change
4383E1	SERVICE PARTS	Parts Assembly	383EW1A005A				R	1		
466001	SWITCH,MICRO	Switch,Micro	6600W1K004C				R	2	6600W1K001D	
466003	SWITCH,MICRO	Switch,Micro	6600W1K004B				R	1	6600W1K001C	
50CZZH	CAPACITOR,DRAWING[HIGH VOLTAGE]	Capacitor,AL,Radial	0CZZW1H004B				R	1	6120W3H003H	
50CZZM	CAPACITOR,DRAWING[MOTOR CONDENSER]	Capacitor,Film,Box	0CZZW1M001C				R	1	3B72440F	
50FZZ1	FUSE,DRAWING	Fuse,Time Delay	3B74133K				R	1		
50FZZ2	FUSE,DRAWING	Fuse,Time Delay	3B70856T				R	1		
53035A	REFLECTOR ASSEMBLY	Reflector Assembly	3035W1A008E	3035W1A008E	3035W1A008E	3035W1A006D	R	1		ADD
53035B	PARTS ASSEMBLY	Parts Assembly	383EW1A136A	383EW1A136A	383EW1A136A	383EW1A136C	R	1		ADD

LOC.NO	OLD DESCRIPTION	NEW DESCRIPTION	DIFFERENCE CHART				SVC	QTY	ALTERNATIVEP ART NO.	REMARKS
			SCA1000HBB/01	SCA1000HBB/02	SCA1000HBB/03	SCA1000HBB/04				
53300A	PLATE,BOTTOM	Plate,Bottom	3300W1A001A				R	1		
53551A	COVER ASSEMBLY,HEATER COVER	Cover Assembly,Heater	3551W1A024A	3551W1A024A	3551W1A024A	3551W1A024A	R	1		Delete
53740A	PROTECTOR (MECH)	Supporter	3740W3A004A				R	1		
538310	SERVICE PARTS(HARNESS TOTAL ASSY)	Parts Assembly	383EW1A030C	383EW1A030C	383EW1A030E	383EW1A030F	R	1		Change
5383E1	SERVICE PARTS(DAMPER INLET ASSY)	Parts Assembly	383EW1A025A	383EW1A025A	383EW1A025B	383EW1A025A	R	1		Change
5383E3	SERVICE PARTS(REFLECTOR-L ASSY)	Parts Assembly	383EW1A024A				R	1		
5383E4	SERVICE PARTS(AIR DUCT+HEATER COVER)	Parts Assembly	383EW1A027A	383EW1A080A	383EW1A080A	383EW1A080A	R	1		Change
5383E5	SERVICE PARTS(LAMP REFLECTOR ASSY)	Parts Assembly	383EW1A028D	383EW1A028D	383EW1A028D	383EW1A028F	R	1		Change
5383E6	SERVICE PARTS(REFLECTOR-U ASSY)	Parts Assembly	383EW1A033A				R	1		
5383E7	SERVICE PARTS(DAMPER OUTLET ASSY)	Parts Assembly	383EW1A029A				R	1		
5383E8	SERVICE PARTS(BLOWER ASSY)	Parts Assembly	383EW1A031A				R	1		
5383E9	SERVICE PARTS(CONVECTION FAN ASSY)	Parts Assembly	383EW1A032A				R	1		
54810Q	BRACKET,MOUNT	Bracket,Mount	4810W2Q001A				R	1		
548111	BRACKET ASSEMBLY	Bracket Assembly	4811W3A016A				R	1		
548112	BRACKET ASSEMBLY	Bracket Assembly	4811W1A003A				R	1		
54890A	GLASS	Window	4890W3A010A				R	1		
54960A	MOUNT	Plate	4960W2A004A				R	1		
54974A	GUIDE,SUCTION	Guide,Suction	4974W0A001A				R	1		
55012A	INSULATOR	Insulator	5012W1A003A				R	1		
55300S	HEATER,SHEATH	Heater,Sheath	5300W1S010B				R	1	5300W1S010A	
55900A	FAN	Fan	2B72125A				R	1		
56010L	TRANSFORMER, LINEAR	Transformer,Linear	-	-	-	6010W2L003D	R	1		ADD
56021B	CABLE ASSEMBLY	Drawing,Assembly	6021W3B001Q	6021W3B001U	6021W3B001U	6021W3B001U	R	1	6021W3B001A	Change
56170D	TRANSFORMER,HIGH VOLTAGE	Transformer,Linear	6170W1D049B				R	1	6170W1D051D	
56170G	TRANSFORMER,POWER	Transformer,Linear	6170W2G015A				R	1		
56201A	FILTER,AC LINE	Filter,AC Line	-	-	2B72130F	2B72130F	R	1		ADD
56322A	THERMISTOR,NTC	Thermistor,NTC	6322W1A001A				R	1		
56324A	MAGNETRON	Magnetron	6324W1A001A				R	1		
56411A	POWER CORD ASSEMBLY	Power Cord Assembly	6411W1A014W	6411W1A014W	6411W1A014U	6411W1A014Y	R	1	6411W1A014V	Change
56501A	SENSOR ASSEMBLY	Sensor Assembly	6501W1A004A				R	1		
56549F	MOTOR(CIRC),FAN	Motor,AC	2B73670L	2B73670L	6549W1F001W	6549W1F001W	R	1		Change
56549V	MOTOR(CIRC),VENTILATION	Motor,AC	6549W1V006B				R	1		
56820A	FUSE HOLDER	Fuse Holder	4930W3B025B	4930W3B025B	4930W3B025B	4930W3B025B	R	1		Delete
56871S	PWB(PCB) ASSEMBLY,SUB	PCB Assembly,Sub	6871W2S246B	6871W2S246B	6871W2S246B	6871W2S246D	R	1		Change
56912H	LAMP,HALOGEN	Lamp,Halogen	6912A40002D	6912A40002D	6912A40002D	6912W3H001C	R	1		ADD
569301	THERMOSTAT	Thermostat	3B70068V				R	1		
569302	THERMOSTAT	Thermostat	6930W1A003D	6930W1A003D	6930W1A003D	6930W1A002E	R	1	6930W1A002F	Change
63301A	PLATE ASSEMBLY	Plate Assembly	3301W1A028A				R	1		
6383E1	SERVICE PARTS(MOUNTING KIT ASSY)	Parts Assembly	383EW2A002A				R	1		
6383E2	SERVICE PARTS(MOUNTING BOTS)	Parts Assembly	383EW1A038A				R	1		
9383EA	SERVICE PARTS(HARDWARE BAG)	Parts Assembly	383EW1A081C				R	1		
WSZ002	SCREW TAP TITE(S),BINDING HEAD	Screw,TapTite	1SBF0402418				R	6		
WSZ084	SCREW,DRAWING	Screw,Customzied	4B70188B				R	2		
WTP015	SCREW TAPPING	Screw,Tapping	1TPL0402618				R	2		
WTT022	SCREW TAPPING,TRUSS HEAD	Screw,Tapping	1TTL0402422				R	13		
WTT028	SCREW TAPPING,TRUSS HEAD	Screw,Tapping	1TTL0402818				R	40		
WTT030	SCREW TAPPING,TRUSS HEAD	Screw,Tapping	1TTL0403118				R	1		

Part Reference list

Rev.5 Mar 13, 2006
 Rev.4 Feb 18, 2005
 Rev.3 Nov 29, 2004
 Rev.2 Nov 05, 2003
 Rev.1 Sep 17, 2003

For Model : SCA1000HCC

LOC.NO	OLD DESCRIPTION	NEW DESCRIPTION	DIFFERENCE CHART				SVC	QTY	ALTERNATIVEP ART NO.	REMARKS
			SCA1000HCC/01	SCA1000HCC/02	SCA1000HCC/03	SCA1000HCC/04				
*01	MANUAL,OWNERS	Manual,Owners	3828W5A3717	3828W5A4680	3828W5A4680	MFL30039301	R	1		Change
*03	COOK BOOK	Book,Cook	3878W5A0034				R	1		
*04	MANUAL,INSTALLATION	Manual,Installation	3828W5U0128				R	1		
*05-1	LABEL,COOKING GUIDE	Label,Cooking Guide	3850W5D002A				R	1		
*05-2	LABEL,COOKING GUIDE	Label,Cooking Guide	3850W5D002B				R	1		
*06-1	TEMPLATE	Card,Template	4922W5A022A				R	1		
*06-2	TEMPLATE	Card,Template	4922W5A024A				R	1		
*07	CARD,TECHNICAL	Card,Technical	3840W5T098E	3840W5T098E	3840W5T0036	MBM30035001	R	1		Change
*10	BOX,YELLOW	Box	3890W3Y735A				R	1		
13552A	CHOKE COVER	Cover,Choke	3552W1A044A	3552W1A044B	3552W1A044B	3552W1A044B	R	1		Change
13581A	DOOR ASSEMBLY	Door Assembly	3581W0A095C				R	1		
13650A	SERVICE PARTS(HANDLE ASSY)	Parts Assembly	383EW1A075C				R	1		
1383E1	SERVICE PARTS(DOOR GLOSS SUB ASSY)	Parts Assembly	383EW1A074C				R	1		
1383E2	SERVICE PARTS(LATCH+SPRING)	Parts Assembly	383EW2A001A				R	1		
2383E1	SERVICE PARTS(CONTROL PANEL ASSY)	Parts Assembly	383EW1A015M				R	1		
2383E2	SERVICE PARTS(KEY PCB ASSY)	Parts Assembly	383EW1A020C				R	1		
2383E3	SERVICE PARTS(BUTTON ASSY)	Parts Assembly	383EW1A019M				R	1		
2383E4	SERVICE PARTS(LED HOLDER ASSY)	Parts Assembly	383EW1A037A				R	1		
24781M	CONTROLLER ASSEMBLY,MICOM	Controller Assembly,Keypad	4781W1M352C				R	1		
24940A	KNOB	Knob	4940W3A019D				R	1		
26871S	PWB(PCB) ASSEMBLY,SUB	PCB Assembly,Sub	6871W1S005D				R	1		
33034A	REFLECTOR	Reflector	3034W1A008A	3034W1A008A	3034W1A008A	3034W2A006A	R	1		Change
33052M	CANOPY,MICA	Cover,Insulator	3052W3M025A				R	1		
33112U	OUT CASE,U-BENDING	Case,U Bending	3112W0U043D				R	1		
33390G	TRAY,GLASS	Tray,Glass	1B71961A				R	1		
33390M	TRAY,METAL	Tray,Metal	3390W2M005B				R	1		
33531A	GRILLE ASSEMBLY	Grille Assembly	3531W1A017G				R	1		
33550P	COVER,POWER CORD	Cover,Power Cord	3550W3A084A				R	1		
33809A	COVER ASSEMBLY,BACK	Cover Assembly,Rear	3809W0A002C				R	1		
3383E1	SERVICE PARTS(T/T MOTOR ASSY)	Parts Assembly	383EW1A022A	383EW1A022A	383EW1A022C	383EW1A022C	R	1		Change
3383E3	SERVICE PARTS(COOKTOP GLASS ASSY)	Parts Assembly	383EW1A021A				R	1		
3383E4	SERVICE PARTS(GREASE FILTER ASSY)	Parts Assembly	383EW1A023A				R	2		
3383E5	SERVICE PARTS(BASE PLATE ASSY)	Parts Assembly	383EW1A036G	383EW1A036G	383EW1A036G	383EW1A036J	R	1		Change
34021A	HOLDER ASSEMBLY	Holder Assembly	4021W3A001A				R	2		
34371A	SHAFT,TURN TABLE	Shaft,Turntable	4371W1A001A				R	1		
34810G	BRACKET,MISC	Bracket,Idle	4810W3G142A				R	2		
34931A	HOLDER ASSEMBLY	Holder Assembly	4931W1A009G	4931W1A009G	4931W1A009G	4931W3A004B	R	1		Change
34960A	MOUNT	Plate	4960W1A008B				R	1		
35889A	ROTATING RING ASSEMBLY	Turntable Assembly	5889W1A001D	5889W1A001D	5889W1A011A	5889W1A011A	R	1		Change
36912H	LAMP,HALOGEN	Lamp,Halogen	6912A40002A	6912A40002A	6912A40002D	6912W3H001D	R	1		Change
4383E1	SERVICE PARTS	Parts Assembly	383EW1A005A				R	1		
466001	SWITCH,MICRO	Switch,Micro	6600W1K004C				R	2		
466003	SWITCH,MICRO	Switch,Micro	6600W1K004B				R	1		
50CZZH	CAPACITOR,DRAWING[HIGH VOLTAGE]	Capacitor,AL,Radial	0CZZW1H004B				R	1		
50CZZM	CAPACITOR,DRAWING[MOTOR CONDENSER]	Capacitor,Film,Box	0CZZW1M001C				R	1		
50FZZ1	FUSE,DRAWING	Fuse,Time Delay	3B74133K				R	1		
50FZZ2	FUSE,DRAWING	Fuse,Time Delay	3B70856T				R	1		
53035A	REFLECTOR ASSEMBLY	Reflector Assembly	3035W1A008E	3035W1A008E	3035W1A008E	3035W1A006D	R	1		ADD
53035B	PARTS ASSEMBLY	Parts Assembly	383EW1A136A	383EW1A136A	383EW1A136A	383EW1A136C	R	1		ADD

LOC.NO	OLD DESCRIPTION	NEW DESCRIPTION	DIFFERENCE CHART				SVC	QTY	ALTERNATIVEP ART NO.	REMARKS
			SCA1000HCC/01	SCA1000HCC/02	SCA1000HCC/03	SCA1000HCC/04				
53300A	PLATE,BOTTOM	Plate,Bottom	3300W1A001A				R	1		
53551A	COVER ASSEMBLY,HEATER COVER	Cover Assembly,Heater	3551W1A024A	3551W1A024A	3551W1A024A	3551W1A024A	R	1		Delete
53740A	PROTECTOR (MECH)	Supporter	3740W3A004A				R	1		
538310	SERVICE PARTS(HARNESS TOTAL ASSY)	Parts Assembly	383EW1A030C	383EW1A030C	383EW1A030E	383EW1A030F	R	1		Change
5383E1	SERVICE PARTS(DAMPER INLET ASSY)	Parts Assembly	383EW1A025A	383EW1A025A	383EW1A025B	383EW1A025A	R	1		Change
5383E3	SERVICE PARTS(REFLECTOR-L ASSY)	Parts Assembly	383EW1A024A				R	1		
5383E4	SERVICE PARTS(AIR DUCT+HEATER COVER)	Parts Assembly	383EW1A027A	383EW1A080A	383EW1A080A	383EW1A080A	R	1		Change
5383E5	SERVICE PARTS(LAMP REFLECTOR ASSY)	Parts Assembly	383EW1A028D	383EW1A028D	383EW1A028D	383EW1A028F	R	1		Change
5383E6	SERVICE PARTS(REFLECTOR-U ASSY)	Parts Assembly	383EW1A033A				R	1		
5383E7	SERVICE PARTS(DAMPER OUTLET ASSY)	Parts Assembly	383EW1A029A				R	1		
5383E8	SERVICE PARTS(BLOWER ASSY)	Parts Assembly	383EW1A031A				R	1		
5383E9	SERVICE PARTS(CONVECTION FAN ASSY)	Parts Assembly	383EW1A032A				R	1		
54810Q	BRACKET,MOUNT	Bracket,Mount	4810W2Q001A				R	1		
548111	BRACKET ASSEMBLY	Bracket Assembly	4811W3A016A				R	1		
548112	BRACKET ASSEMBLY	Bracket Assembly	4811W1A003A				R	1		
54890A	GLASS	Window	4890W3A010A				R	1		
54960A	MOUNT	Plate	4960W2A004A				R	1		
54974A	GUIDE,SUCTION	Guide,Suction	4974W0A001A				R	1		
55012A	INSULATOR	Insulator	5012W1A003A				R	1		
55300S	HEATER,SHEATH	Heater,Sheath	5300W1S010B				R	1		
55900A	FAN	Fan	2B72125A				R	1		
56010L	TRANSFORMER, LINEAR	Transformer,Linear	-	-	-	6010W2L003D	R	1		ADD
56021B	CABLE ASSEMBLY	Drawing,Assembly	6021W3B001Q	6021W3B001U	6021W3B001U	6021W3B001U	R	1		Change
56170D	TRANSFORMER,HIGH VOLTAGE	Transformer,Linear	6170W1D049B				R	1		
56170G	TRANSFORMER,POWER	Transformer,Linear	6170W2G015A				R	1		
56201A	FILTER,AC LINE	Filter,AC Line	-	-	2B72130F	2B72130F	R	1		ADD
56322A	THERMISTOR,NTC	Thermistor,NTC	6322W1A001A				R	1		
56324A	MAGNETRON	Magnetron	6324W1A001A				R	1		
56411A	POWER CORD ASSEMBLY	Power Cord Assembly	6411W1A014W	6411W1A014W	6411W1A014U	6411W1A014Y	R	1		Change
56501A	SENSOR ASSEMBLY	Sensor Assembly	6501W1A004A				R	1		
56549F	MOTOR(CIRC),FAN	Motor,AC	2B73670L	2B73670L	6549W1F001W	6549W1F001W	R	1		Change
56549V	MOTOR(CIRC),VENTILATION	Motor,AC	6549W1V006B				R	1		
56820A	FUSE HOLDER	Fuse Holder	4930W3B025B	4930W3B025B	4930W3B025B	4930W3B025B	R	1		Delete
56871S	PWB(PCB) ASSEMBLY,SUB	PCB Assembly,Sub	6871W2S246B	6871W2S246B	6871W2S246B	6871W2S246D	R	1		Change
56912H	LAMP,HALOGEN	Lamp,Halogen	6912A40002D	6912A40002D	6912A40002D	6912W3H001C	R	1		ADD
569301	THERMOSTAT	Thermostat	3B70068V				R	1		
569302	THERMOSTAT	Thermostat	6930W1A003D	6930W1A003D	6930W1A003D	6930W1A002E	R	1		Change
63301A	PLATE ASSEMBLY	Plate Assembly	3301W1A028A				R	1		
6383E1	SERVICE PARTS(MOUNTING KIT ASSY)	Parts Assembly	383EW2A002A				R	1		
6383E2	SERVICE PARTS(MOUNTING BOTS)	Parts Assembly	383EW1A038A				R	1		
9383EA	SERVICE PARTS(HARDWARE BAG)	Parts Assembly	383EW1A081C				R	1		ADD
WSZ002	SCREW TAP TITE(S),BINDING HEAD	Screw,TapTite	1SBF0402418				R	6		
WSZ084	SCREW,DRAWING	Screw,Customzied	4B70188B				R	2		
WTP015	SCREW TAPPING	Screw,Tapping	1TPL0402618							
WTT022	SCREW TAPPING,TRUSS HEAD	Screw,Tapping	1TTL0402422				R	13		
WTT028	SCREW TAPPING,TRUSS HEAD	Screw,Tapping	1TTL0402818				R	40		
WTT030	SCREW TAPPING,TRUSS HEAD	Screw,Tapping	1TTL0403118				R	1		

Part Reference list

Rev.5 Mar 13, 2006
 Rev.4 Feb 18, 2005
 Rev.3 Nov 29, 2004
 Rev.2 Nov 05, 2003
 Rev.1 Sep 17, 2003

For Model : SCA1000HWW

LOC.NO	OLD DESCRIPTION	NEW DESCRIPTION	DIFFERENCE CHART				SVC	QTY	ALTERNATIVEP ART NO.	REMARKS
			SCA1000HWW/01	SCA1000HWW/02	SCA1000HWW/03	SCA1000HWW/04				
*01	MANUAL,OWNERS	Manual,Owners	3828W5A3717	3828W5A4680	3828W5A4680	MFL30039301	R	1		Change
*03	COOK BOOK	Book,Cook	3878W5A0034				R	1		
*04	MANUAL,INSTALLATION	Manual,Installation	3828W5U0128				R	1		
*05-1	LABEL,COOKING GUIDE	Label,Cooking Guide	3850W5D002A				R	1		
*05-2	LABEL,COOKING GUIDE	Label,Cooking Guide	3850W5D002B				R	1		
*06-1	TEMPLATE	Card,Template	4922W5A022A				R	1		
*06-2	TEMPLATE	Card,Template	4922W5A024A				R	1		
*07	CARD,TECHNICAL	Card,Technical	3840W5T098E	3840W5T098E	3840W5T0036	MBM30035001	R	1		Change
*10	BOX,YELLOW	Box	3890W3Y735A				R	1		
13552A	CHOKE COVER	Cover,Choke	3552W1A044A	3552W1A044B	3552W1A044B	3552W1A044B	R	1		Change
13581A	DOOR ASSEMBLY	Door Assembly	3581W0A095A				R	1		
13650A	SERVICE PARTS(HANDLE ASSY)	Parts Assembly	383EW1A075A				R	1		
1383E1	SERVICE PARTS(DOOR GLOSS SUB ASSY)	Parts Assembly	383EW1A074A				R	1		
1383E2	SERVICE PARTS(LATCH+SPRING)	Parts Assembly	383EW2A001A				R	1		
2383E1	SERVICE PARTS(CONTROL PANEL ASSY)	Parts Assembly	383EW1A015K				R	1		
2383E2	SERVICE PARTS(KEY PCB ASSY)	Parts Assembly	383EW1A020C				R	1		
2383E3	SERVICE PARTS(BUTTON ASSY)	Parts Assembly	383EW1A019K				R	1		
2383E4	SERVICE PARTS(LED HOLDER ASSY)	Parts Assembly	383EW1A037A				R	1		
24781M	CONTROLLER ASSEMBLY,MICOM	Controller Assembly,Keypad	4781W1M352A				R	1		
24940A	KNOB	Knob	4940W3A019A				R	1		
26871S	PWB(PCB) ASSEMBLY,SUB	PCB Assembly,Sub	6871W1S005D				R	1		
33034A	REFLECTOR	Reflector	3034W1A008A	3034W1A008A	3034W1A008A	3034W2A006A	R	1		Change
33052M	CANOPY,MICA	Cover,Insulator	3052W3M025A				R	1		
33112U	OUT CASE,U-BENDING	Case,U Bending	3112W0U043A				R	1		
33390G	TRAY,GLASS	Tray,Glass	1B71961A				R	1	1B71961E	
33390M	TRAY,METAL	Tray,Metal	3390W2M005B				R	1		
33531A	GRILLE ASSEMBLY	Grille Assembly	3531W1A017E				R	1		
33550P	COVER,POWER CORD	Cover,Power Cord	3550W3A084A				R	1		
33809A	COVER ASSEMBLY,BACK	Cover Assembly,Rear	3809W0A002C				R	1		
3383E1	SERVICE PARTS(T/T MOTOR ASSY)	Parts Assembly	383EW1A022A	383EW1A022A	383EW1A022C	383EW1A022C	R	1		Change
3383E3	SERVICE PARTS(COOKTOP GLASS ASSY)	Parts Assembly	383EW1A021A				R	1		
3383E4	SERVICE PARTS(GREASE FILTER ASSY)	Parts Assembly	383EW1A023A				R	2		
3383E5	SERVICE PARTS(BASE PLATE ASSY)	Parts Assembly	383EW1A036G	383EW1A036G	383EW1A036G	383EW1A036J	R	1		Change
34021A	HOLDER ASSEMBLY	Holder Assembly	4021W3A001A				R	2		
34371A	SHAFT,TURN TABLE	Shaft,Turntable	4371W1A001A				R	1		
34810G	BRACKET,MISC	Bracket,Idle	4810W3G142A				R	2		
34931A	HOLDER ASSEMBLY	Holder Assembly	4931W1A009G	4931W1A009G	4931W1A009G	4931W3A004B	R	1		Change
34960A	MOUNT	Plate	4960W1A008B				R	1		
35889A	ROTATING RING ASSEMBLY	Turntable Assembly	5889W1A001D	5889W1A001D	5889W1A011A	5889W1A011A	R	1		Change
36912H	LAMP,HALOGEN	Lamp,Halogen	6912A40002A	6912A40002A	6912A40002D	6912W3H001D	R	1		Change
4383E1	SERVICE PARTS	Parts Assembly	383EW1A005A				R	1		
466001	SWITCH,MICRO	Switch,Micro	6600W1K004C				R	2	6600W1K001D	
466003	SWITCH,MICRO	Switch,Micro	6600W1K004B				R	1	6600W1K001C	
50CZZH	CAPACITOR,DRAWING[HIGH VOLTAGE]	Capacitor,AL,Radial	0CZZW1H004B				R	1	6120W3H003H	
50CZZM	CAPACITOR,DRAWING[MOTOR CONDENSER]	Capacitor,Film,Box	0CZZW1M001C				R	1	3B72440F	
50FZZ1	FUSE,DRAWING	Fuse,Time Delay	3B74133K				R	1		
50FZZ2	FUSE,DRAWING	Fuse,Time Delay	3B70856T				R	1		
53035A	REFLECTOR ASSEMBLY	Reflector Assembly	3035W1A008E	3035W1A008E	3035W1A008E	3035W1A006D	R	1		ADD
53035B	PARTS ASSEMBLY	Parts Assembly	383EW1A136A	383EW1A136A	383EW1A136A	383EW1A136C	R	1		ADD

LOC.NO	OLD DESCRIPTION	NEW DESCRIPTION	DIFFERENCE CHART				SVC	QTY	ALTERNATIVEP ART NO.	REMARKS
			SCA1000HWW/01	SCA1000HWW/02	SCA1000HWW/03	SCA1000HWW/04				
53300A	PLATE,BOTTOM	Plate,Bottom	3300W1A001A				R	1		
53551A	COVER ASSEMBLY,HEATER COVER	Cover Assembly,Heater	3551W1A024A	3551W1A024A	3551W1A024A	3551W1A024A	R	1		Delete
53740A	PROTECTOR (MECH)	Supporter	3740W3A004A				R	1		
538310	SERVICE PARTS(HARNESS TOTAL ASSY)	Parts Assembly	383EW1A030C	383EW1A030C	383EW1A030E	383EW1A030F	R	1		Change
5383E1	SERVICE PARTS(DAMPER INLET ASSY)	Parts Assembly	383EW1A025A	383EW1A025A	383EW1A025B	383EW1A025A	R	1		Change
5383E3	SERVICE PARTS(REFLECTOR-L ASSY)	Parts Assembly	383EW1A024A				R	1		
5383E4	SERVICE PARTS(AIR DUCT+HEATER COVER)	Parts Assembly	383EW1A027A	383EW1A080A	383EW1A080A	383EW1A080A	R	1		Change
5383E5	SERVICE PARTS(LAMP REFLECTOR ASSY)	Parts Assembly	383EW1A028D	383EW1A028D	383EW1A028D	383EW1A028F	R	1		Change
5383E6	SERVICE PARTS(REFLECTOR-U ASSY)	Parts Assembly	383EW1A033A				R	1		
5383E7	SERVICE PARTS(DAMPER OUTLET ASSY)	Parts Assembly	383EW1A029A				R	1		
5383E8	SERVICE PARTS(BLOWER ASSY)	Parts Assembly	383EW1A031A				R	1		
5383E9	SERVICE PARTS(CONVECTION FAN ASSY)	Parts Assembly	383EW1A032A				R	1		
54810Q	BRACKET,MOUNT	Bracket,Mount	4810W2Q001A				R	1		
548111	BRACKET ASSEMBLY	Bracket Assembly	4811W3A016A				R	1		
548112	BRACKET ASSEMBLY	Bracket Assembly	4811W1A003A				R	1		
54890A	GLASS	Window	4890W3A010A				R	1		
54960A	MOUNT	Plate	4960W2A004A				R	1		
54974A	GUIDE,SUCTION	Guide,Suction	4974W0A001A				R	1		
55012A	INSULATOR	Insulator	5012W1A003A				R	1		
55300S	HEATER,SHEATH	Heater,Sheath	5300W1S010B				R	1	5300W1S010A	
55900A	FAN	Fan	2B72125A				R	1		
56010L	TRANSFORMER, LINEAR	Transformer,Linear	-	-	-	6010W2L003D	R	1		ADD
56021B	CABLE ASSEMBLY	Drawing,Assembly	6021W3B001Q	6021W3B001U	6021W3B001U	6021W3B001U	R	1	6021W3B001A	Change
56170D	TRANSFORMER,HIGH VOLTAGE	Transformer,Linear	6170W1D049B				R	1	6170W1D051D	
56170G	TRANSFORMER,POWER	Transformer,Linear	6170W2G015A				R	1		
56201A	FILTER,AC LINE	Filter,AC Line	-	-	2B72130F	2B72130F	R	1		ADD
56322A	THERMISTOR,NTC	Thermistor,NTC	6322W1A001A				R	1		
56324A	MAGNETRON	Magnetron	6324W1A001A				R	1		
56411A	POWER CORD ASSEMBLY	Power Cord Assembly	6411W1A014W	6411W1A014W	6411W1A014U	6411W1A014Y	R	1	6411W1A014V	Change
56501A	SENSOR ASSEMBLY	Sensor Assembly	6501W1A004A				R	1		
56549F	MOTOR(CIRC),FAN	Motor,AC	2B73670L	2B73670L	6549W1F001W	6549W1F001W	R	1		Change
56549V	MOTOR(CIRC),VENTILATION	Motor,AC	6549W1V006B				R	1		
56820A	FUSE HOLDER	Fuse Holder	4930W3B025B	4930W3B025B	4930W3B025B	4930W3B025B	R	1		Delete
56871S	PWB(PCB) ASSEMBLY,SUB	PCB Assembly,Sub	6871W2S246B	6871W2S246B	6871W2S246B	6871W2S246D	R	1		Change
56912H	LAMP,HALOGEN	Lamp,Halogen	6912A40002D	6912A40002D	6912A40002D	6912W3H001C	R	1		ADD
569301	THERMOSTAT	Thermostat	3B70068V				R	1		
569302	THERMOSTAT	Thermostat	6930W1A003D	6930W1A003D	6930W1A003D	6930W1A002E	R	1	6930W1A002F	Change
63301A	PLATE ASSEMBLY	Plate Assembly	3301W1A028A				R	1		
6383E1	SERVICE PARTS(MOUNTING KIT ASSY)	Parts Assembly	383EW2A002A				R	1		
6383E2	SERVICE PARTS(MOUNTING BOTS)	Parts Assembly	383EW1A038A				R	1		
9383EA	SERVICE PARTS(HARDWARE BAG)	Parts Assembly	383EW1A081C				R	1		
WSZ002	SCREW TAP TITE(S),BINDING HEAD	Screw,TapTite	1SBF0402418				R	6		
WSZ084	SCREW,DRAWING	Screw,Customzied	4B70188B				R	2		
WTP015	SCREW TAPPING	Screw,Tapping	1TPL0402618				R	2		
WTT022	SCREW TAPPING,TRUSS HEAD	Screw,Tapping	1TTL0402422				R	13		
WTT028	SCREW TAPPING,TRUSS HEAD	Screw,Tapping	1TTL0402818				R	40		
WTT030	SCREW TAPPING,TRUSS HEAD	Screw,Tapping	1TTL0403118				R	1		

Part Reference list

Rev.2 Mar 13, 2006
Rev.1 Jun 28, 2005

For Model : SCA1001KSS

LOC.NO	OLD DESCRIPTION	NEW DESCRIPTION	DIFFERENCE CHART			SVC	QTY	ALTERNATIVEP ART NO.	REMARKS
			SCA1001HSS/03	SCA1001KSS/01	SCA1001KSS/02				
*01	MANUAL,OWNERS	Manual,Owners	3828W5A3717	3828W5A4680	MFL30039301	R	1		Change
*03	COOK BOOK	Book,Cook	3878W5A0034			R	1		
*04	MANUAL,INSTALLATION	Manual,Installation	3828W5U0128			R	1		
*05-1	LABEL,COOKING GUIDE	Label,Cooking Guide	3850W5D002A			R	1		
*05-2	LABEL,COOKING GUIDE	Label,Cooking Guide	3850W5D002B			R	1		
*06-1	TEMPLATE	Card,Template	4922W5A022A			R	1		
*06-2	TEMPLATE	Card,Template	4922W5A024A			R	1		
*07	CARD,TECHNICAL	Card,Technical	3840W1T0030	3840W1T0030	MBM30035001	R	1		Change
*10	BOX,YELLOW	Box	3890W3Y735A			R	1		
13552A	CHOKE COVER	Cover,Choke	3552W1A044A	3552W1A044B	3552W1A044B	R	1		Change
13581A	DOOR ASSEMBLY	Door Assembly	3581W0A100A	3581W0A100C	3581W0A100C	R	1		Change
13650A	HANDLE ASSEMBLY	Parts Assembly	3651W1A019A	3651W1A019B	3651W1A019C	R	1	3651W1A019B	Change
1383E1	SERVICE PARTS(DOOR GLOSS SUB ASSY)	Parts Assembly	383EW1A074D			R	1		
1383E2	SERVICE PARTS(LATCH+SPRING)	Parts Assembly	383EW2A001A			R	1		
2383E1	SERVICE PARTS(CONTROL PANEL ASSY)	Parts Assembly	383EW1A015N			R	1		
2383E2	SERVICE PARTS(KEY PCB ASSY)	Parts Assembly	383EW1A020C			R	1		
2383E3	SERVICE PARTS(BUTTON ASSY)	Parts Assembly	383EW1A019N			R	1		
2383E4	SERVICE PARTS(LED HOLDER ASSY)	Parts Assembly	383EW1A037A			R	1		
24781M	CONTROLLER ASSEMBLY,KEY PAD	Controller Assembly,Keypad	4781W1M352D			R	1		
24940A	KNOB	Knob	4940W3A019F			R	1		
26871S	PWB(PCB) ASSEMBLY,SUB	PCB Assembly,Sub	6871W1S005D			R	1		
33034A	REFLECTOR	Reflector	3034W1A008A	3034W1A008A	3034W2A006A	R	1		Change
33052M	CANOPY,MICA	Cover,Insulator	3052W3M025A			R	1		
33112U	OUT CASE,U-BENDING	Case,U Bending	3112W0U043B			R	1		
33390G	TRAY,GLASS	Tray,Glass	1B71961A			R	1	1B71961E	
33390M	TRAY,METAL	Tray,Metal	3390W2M005B			R	1		
33531A	GRILLE ASSEMBLY	Grille Assembly	3531W1A017H			R	1		
33550P	COVER,POWER CORD	Cover,Power Cord	3550W3A084A			R	1		
33809A	COVER ASSEMBLY,BACK	Cover Assembly,Rear	3809W0A002C			R	1		
3383E1	SERVICE PARTS(T/T MOTOR ASSY)	Parts Assembly	383EW1A022C			R	1		
3383E3	SERVICE PARTS(COOKTOP GLASS ASSY)	Parts Assembly	383EW1A021B			R	2		
3383E4	SERVICE PARTS(GREASE FILTER ASSY)	Parts Assembly	383EW1A023A			R	1		
3383E5	SERVICE PARTS(BASE PLATE ASSY)	Parts Assembly	383EW1A036H	383EW1A036H	383EW1A036K	R	2		Change
34021A	HOLDER ASSEMBLY	Holder Assembly	4021W3A001A			R	1		
34371A	SHAFT,TURN TABLE	Shaft,Turtable	4371W1A001A			R	2		
34810G	BRACKET,MISC	Bracket,Idle	4810W3G142A			R	1		
34931A	HOLDER ASSEMBLY	Holder Assembly	4931W1A009G	4931W1A009G	4931W3A004B	R	1	4931W1A009A	Change
34960A	MOUNT	Plate	4960W1A008B			R	1		
35889A	ROTATING RING ASSEMBLY	Turtable Assembly	5889W1A011A	5889W1A001D	5889W1A011A	R	1	5889W1A011A	Change
36912H	LAMP,HALOGEN	Lamp,Halogen	6912A40002A	6912A40002D	6912W3H001D	R	1		Change
4383E1	SERVICE PARTS (LATCH BRACKET)	Parts Assembly	383EW1A005A			R	2		
466001	SWITCH,MICRO	Switch,Micro	6600W1K004C			R	1	6600W1K001D	
466003	SWITCH,MICRO	Switch,Micro	6600W1K004B			R	1	6600W1K001C	
50CZZH	CAPACITOR,DRAWING[HIGH VOLTAGE]	Capacitor,AL,Radial	0CZZW1H004B			R	1	6120W3H003H	
50CZZM	CAPACITOR,DRAWING[MOTOR CONDENSER]	Capacitor,Film,Box	0CZZW1M001C			R	1	3B72440F	
50FZZ1	FUSE,DRAWING	Fuse,Time Delay	3B74133K			R	1		
50FZZ2	FUSE,DRAWING	Fuse,Time Delay	3B70856T			R	1		
53035A	REFLECTOR ASSEMBLY	Reflector Assembly	-	-	3035W1A006D	R	1		ADD
53035B	PARTS ASSEMBLY	Parts Assembly	-	-	383EW1A136C	R	1		ADD

LOC.NO	OLD DESCRIPTION	NEW DESCRIPTON	DIFFERENCE CHART			SVC	QTY	ALTERNATIVEP ART NO.	REMARKS
			SCA1001HSS/03	SCA1001KSS/01	SCA1001KSS/02				
53300A	PLATE,BOTTOM	Plate,Bottom	3300W1A001A			R	1		
53740A	PROTECTOR (MECH)	Supporter	3740W3A004A			R	1		
538310	SERVICE PARTS(HARNESS TOTAL ASSY)	Parts Assembly	383EW1A030E	383EW1A030E	383EW1A030F	R	1		Change
5383E1	SERVICE PARTS(DAMPER INLET ASSY)	Parts Assembly	383EW1A025A			R	1		
5383E3	SERVICE PARTS(REFLECTOR-L ASSY)	Parts Assembly	383EW1A024A			R	1		
5383E4	SERVICE PARTS(AIR DUCT+HEATER COVER)	Parts Assembly	383EW1A080A			R	1		
5383E5	SERVICE PARTS(LAMP REFLECTOR ASSY)	Parts Assembly	383EW1A028D	383EW1A028D	383EW1A028F	R	1		Change
5383E6	SERVICE PARTS(REFLECTOR-U ASSY)	Parts Assembly	383EW1A033A			R	1		
5383E7	SERVICE PARTS(DAMPER OUTLET ASSY)	Parts Assembly	383EW1A029A			R	1		
5383E8	SERVICE PARTS(BLOWER ASSY)	Parts Assembly	383EW1A031A			R	1		
5383E9	SERVICE PARTS(CONVECTION FAN ASSY)	Parts Assembly	383EW1A032A			R	1		
54810Q	BRACKET,MOUNT	Bracket,Mount	4810W2Q001A			R	1		
548111	BRACKET ASSEMBLY	Bracket Assembly	4811W3A016A			R	1		
548112	BRACKET ASSEMBLY	Bracket Assembly	4811W1A003A			R	1		
54890A	GLASS	Window	4890W3A010A			R	1		
54960A	MOUNT	Plate	4960W2A004A			R	1		
54974A	GUIDE,SUCTION	Guide,Suction	4974W0A001A			R	1		
55012A	INSULATOR	Insulator	5012W1A003A			R	1		
55300S	HEATER,SHEATH	Heater,Sheath	5300W1S010B			R	1	5300W1S010A	
55900A	FAN	Fan	2B72125A			R	1		
56010L	TRANSFORMER, LINEAR	Transformer,Linear	-	-	6010W2L003D	R	1		ADD
56021B	CABLE ASSEMBLY	Drawing,Assembly	6021W3B001Q	6021W3B001U	6021W3B001U	R	1	6021W3B001A	Change
56170D	TRANSFORMER,HIGH VOLTAGE	Transformer,Linear	6170W1D049B			R	1	6170W1D051D	
56170G	TRANSFORMER,POWER	Transformer,Linear	6170W2G015A			R	1		
56201A	FILTER ASSEMBLY(CIRC)	Filter,AC Line	2B72130F			R	1		
56322A	THERMISTOR,NTC	Thermistor,NTC	6322W1A001A			R	1		
56324A	MAGNETRON	Magnetron	6324W1A001A			R	1		
56411A	POWER CORD ASSEMBLY	Power Cord Assembly	6411W1A014U	6411W1A014Y	6411W1A014Y	R	1	6411W1A014V	Change
56501A	SENSOR ASSEMBLY	Sensor Assembly	6501W1A004A			R	1		
56549F	MOTOR(CIRC),FAN	Motor,AC	6549W1F001W			R	1		
56549V	MOTOR(CIRC),VENTILATION	Motor,AC	6549W1V006B			R	1		
56871S	PWB(PCB) ASSEMBLY,SUB	PCB Assembly,Sub	6871W2S246B	6871W2S246B	6871W2S246D	R	1	6871W2S246C	Change
56912H	LAMP,HALOGEN	Lamp,Halogen	-	-	6912W3H001C	R	1		ADD
569301	THERMOSTAT	Thermostat	3B70068V			R	1	6930W1A003M	
569302	THERMOSTAT	Thermostat	6930W1A003D	6930W1A002E	6930W1A002E	R	1	6930W1A002F	Change
63301A	PLATE ASSEMBLY	Plate Assembly	3301W1A028A			R	1		
6383E1	SERVICE PARTS(MOUNTING KIT ASSY)	Parts Assembly	383EW2A002A			R	1		
6383E2	SERVICE PARTS(MOUNTING BOTS)	Parts Assembly	383EW1A038A			R	1		
9383EA	SERVICE PARTS(HARDWARE BAG)	Parts Assembly	383EW1A081C			R	1		
WSZ002	SCREW TAP TITE(S),BINDING HEAD	Screw,Taptitle	1SBF0402418			R	6		
WSZ084	SCREW,DRAWING	Screw,Customized	4B70188B			R	2		
WTP015	SCREW TAPPING	Screw,Tapping	1TPL0402618			R	2		
WTT022	SCREW TAPPING,TRUSS HEAD	Screw,Tapping	1TTL0402422			R	13		
WTT028	SCREW TAPPING,TRUSS HEAD	Screw,Tapping	1TTL0402818			R	40		
WTT030	SCREW TAPPING,TRUSS HEAD	Screw,Tapping	1TTL0403118			R	1		