

This Owner's Manual is provided and hosted by [Appliance Factory Parts](http://www.ApplianceFactoryParts.com).



# GE SCA2000BAA03 Owner's Manual

[Shop genuine replacement parts for GE SCA2000BAA03](#)

## DOOR PARTS

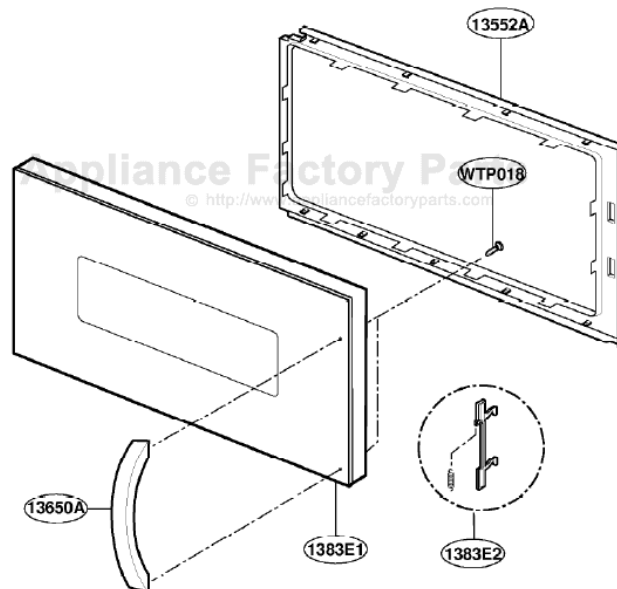

[Find Your GE Microwave Parts - Select From 3055 Models](#)

----- Manual continues below -----

# EXPLODED VIEW

## DOOR PARTS

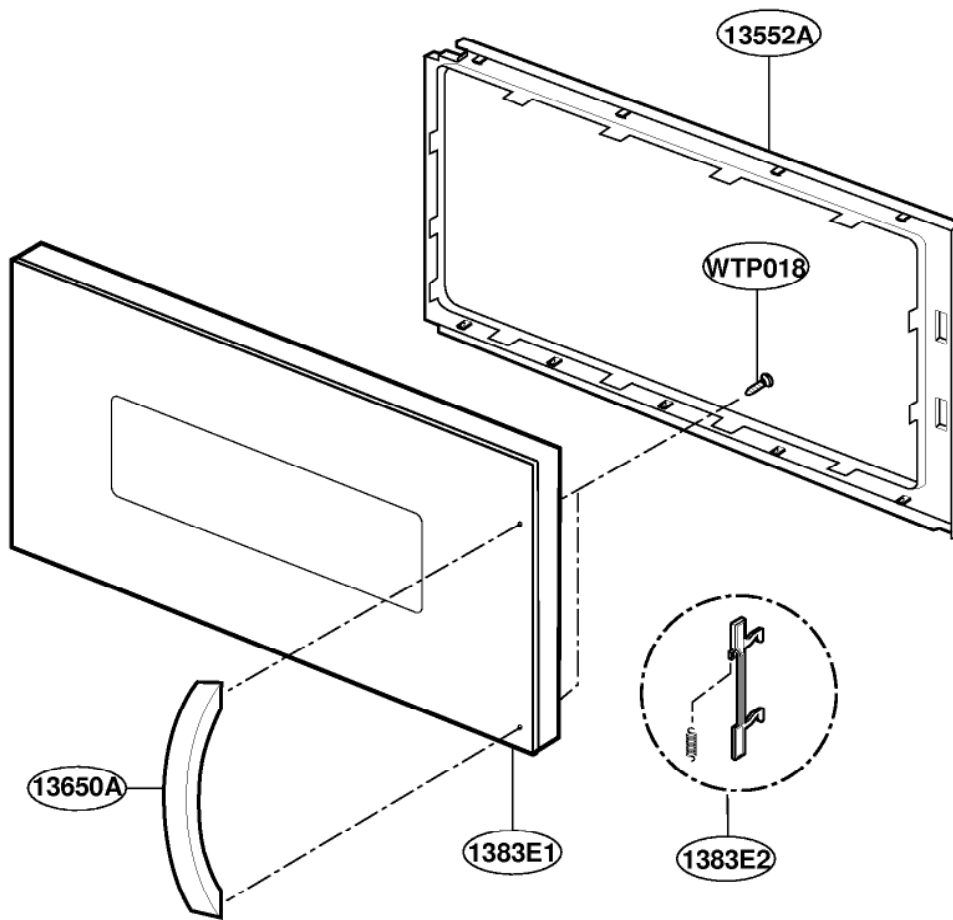

# CONTROLLER PARTS

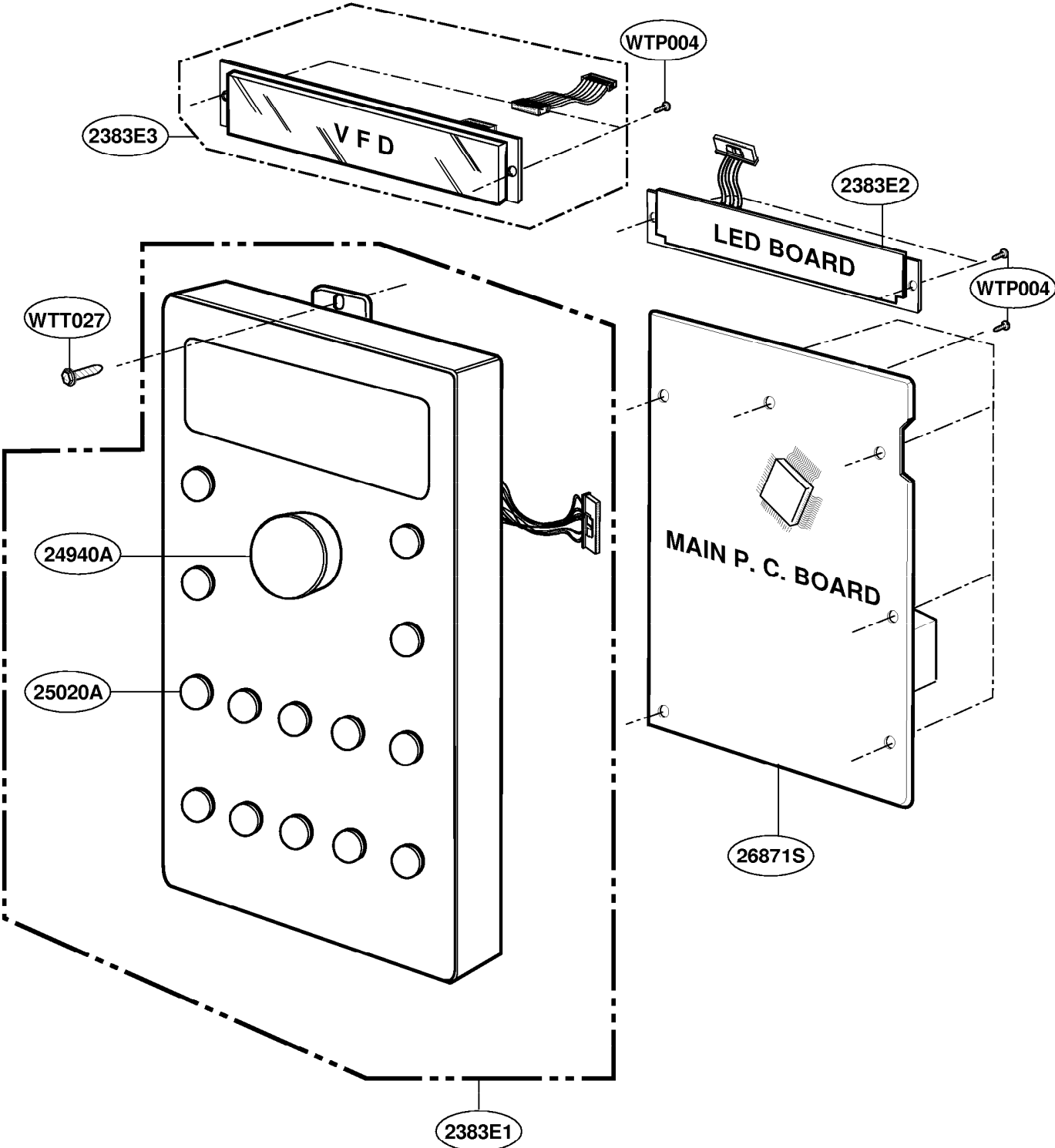

# OVEN CAVITY PARTS

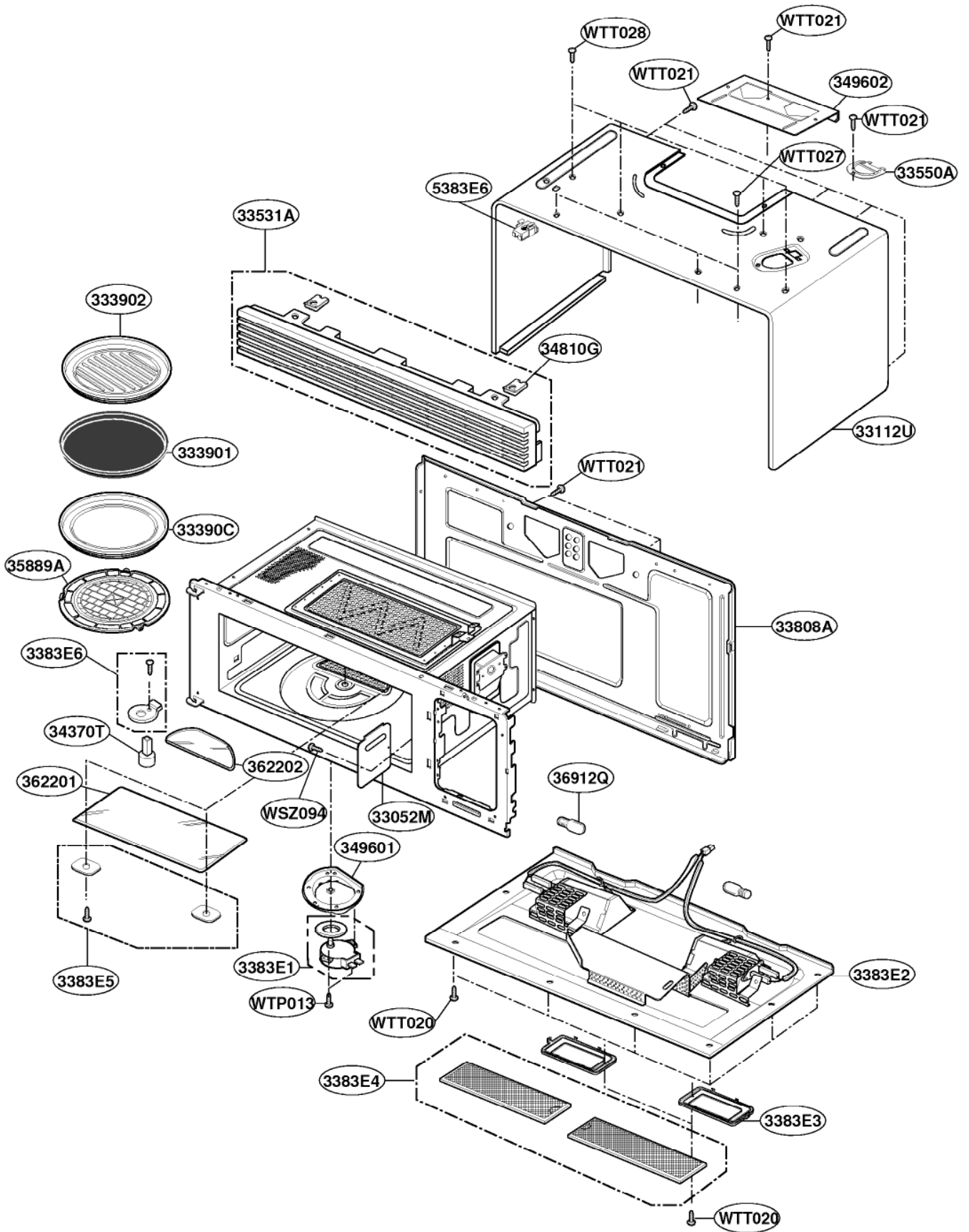

# LATCH BOARD PARTS

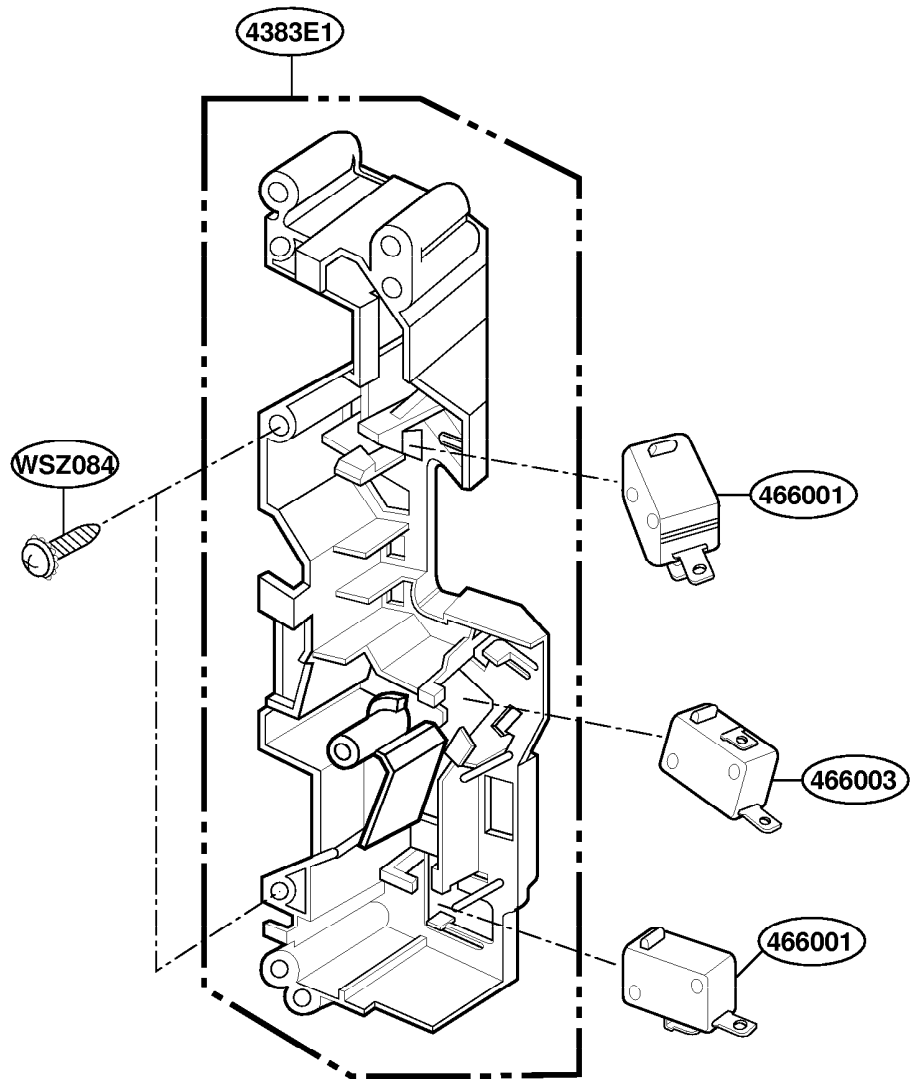

# INTERIOR PARTS (I)

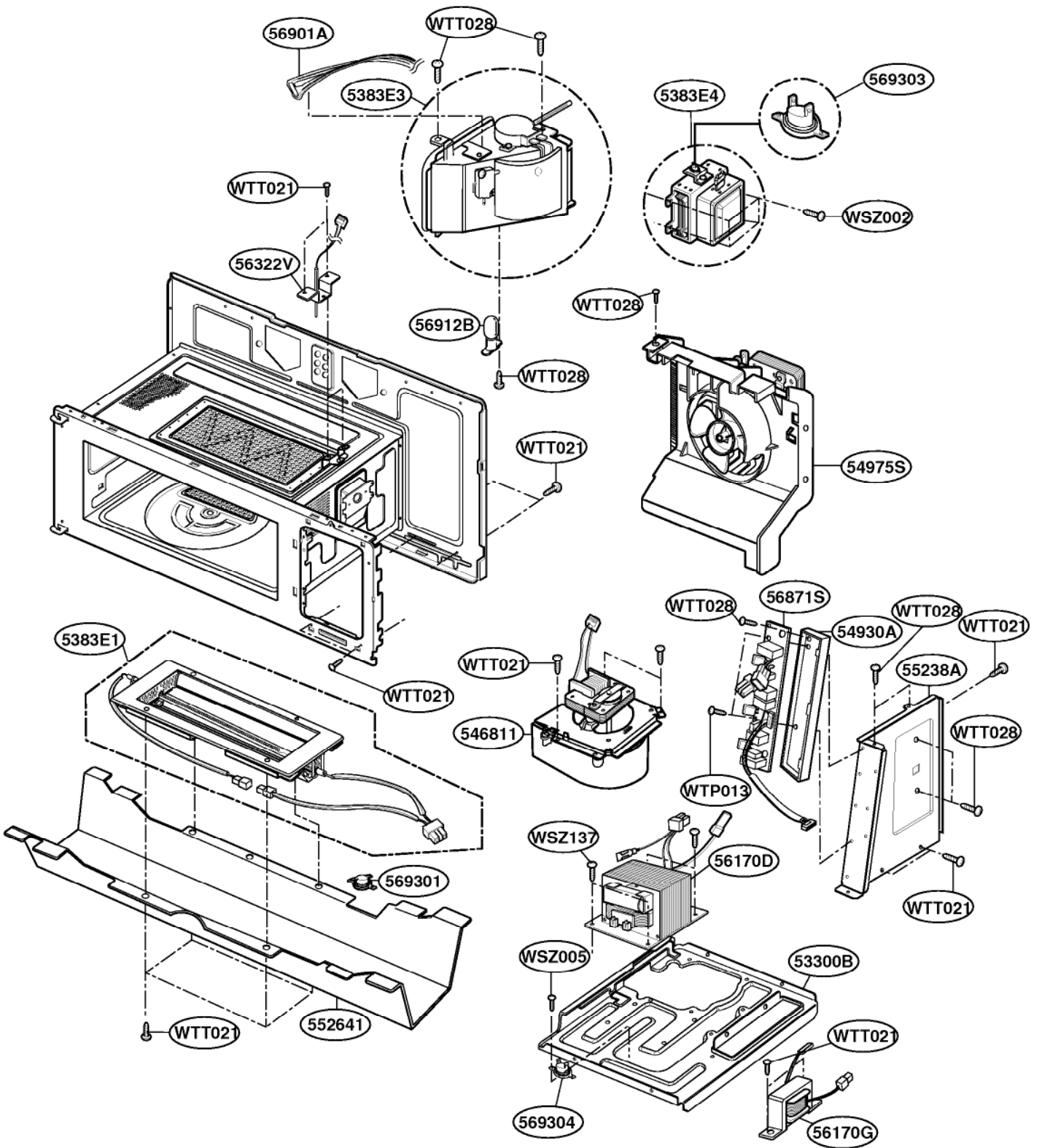

# INTERIOR PARTS (II)

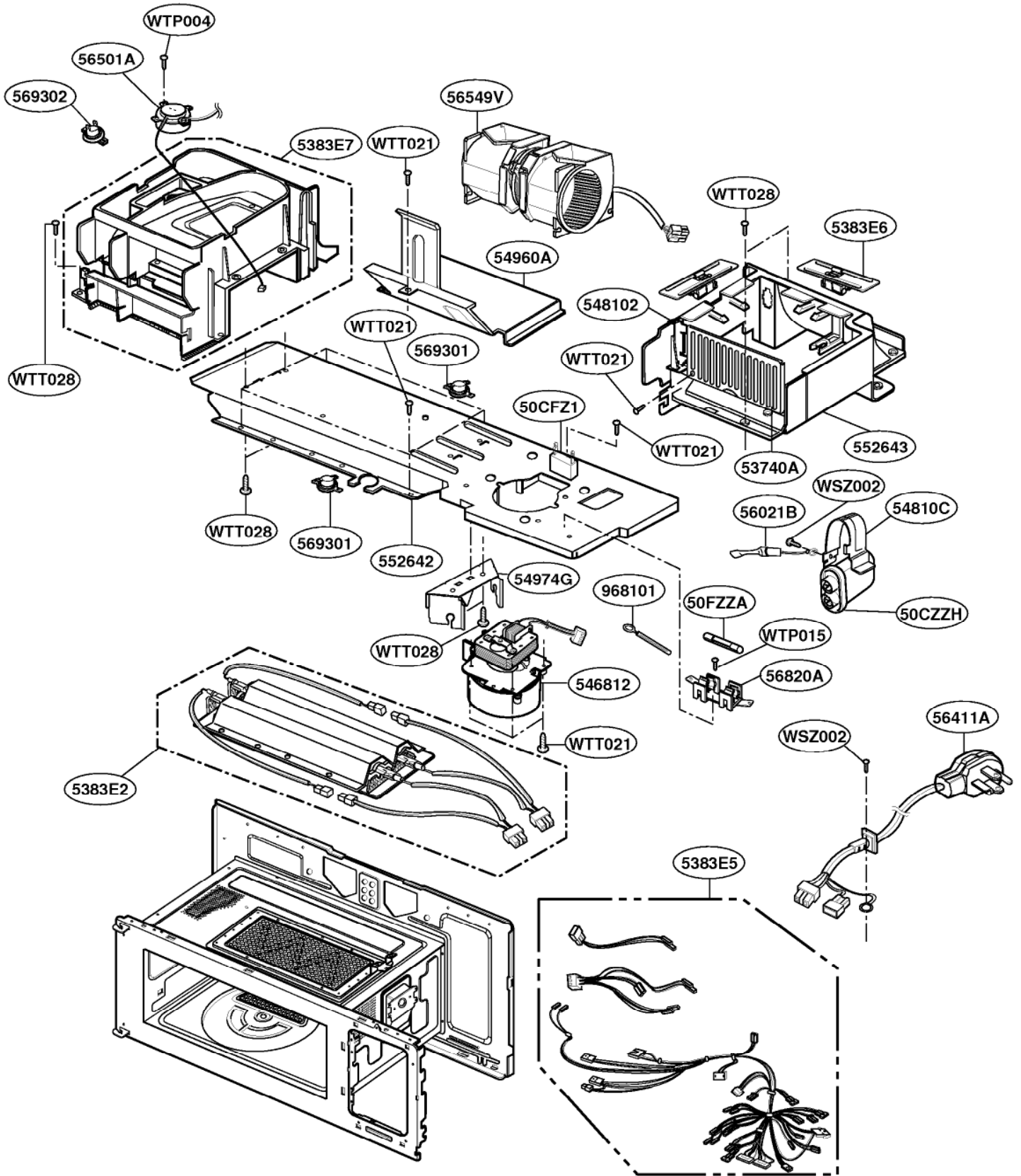

# INSTALLATION PARTS

