

How to get the best from **Your Spacemaker™ Laundry**

Contents

Appliance Registration	2	Repair Service	26
Care and Cleaning	25	Safety Instructions	3, 4
Cautions	16	User Maintenance Instructions	25
Controls Setting Guide	8, 9	Vacation Tips	25
Dryer		Warranty	Back Cover
Automatic Drying	7	Washer	
Controls	7	Agitator	25
Dryness Selections	7	Controls	6
End-of-Cycle Signal	7	Detergents, Other Additives	11-15
Energy-Saving Tips	7	Energy-Saving Tips	7
Knits Drying Tips	7	Hard Water	14
Lint Filter	7	Limestone Deposits	12
Operating Instructions	7	Lint Filter	6, 25
Perm. Press Drying Tips	7, 23	Loading Clothes	6
Sorting	5	Operating Instructions	6
Timed Drying	7	Sorting	5
Energy-Saving Tips	10	Stains	16
Front Access Panel	25	Stain Removal Guide	17
Model and Serial Numbers	2		
Problem Solver	18-24		

Use and Care of
model
WSM2000H

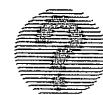

Your Direct Line to General Electric
The GE Answer Center® 800.626.2000

EFF DATE

3-29-88

A Quality Product of GENERAL ELECTRIC COMPANY

18
49-9603

Help us help you...

Before using your Spacemaker™ Laundry, read this book carefully.

It is intended to help you operate and maintain your new appliance properly.

Keep it handy for answers to your questions.

If you don't understand something or need more help, write (include your phone number):

Consumer Affairs
GE Appliances
Appliance Park
Louisville, KY 40225

If you received a damaged appliance...

Immediately contact the dealer (or builder) that sold you the appliance.

Save time and money.

Before you request service... check the Problem Solver on pages 18 through 24. It lists causes of minor operating problems that you can correct yourself.

All washing and drying instruction terms in this book conform to the Care Labeling Rule established by the Federal Trade Commission, January 1984.

Write down the model and serial numbers.

You'll find them on a label on the inside of the door or the rating plate on top of the dryer.

These numbers are also on the Consumer Product Ownership Registration Card that came with your appliance. Before sending in this card, please write these numbers here:

Model Number

Serial Number

Use these numbers in any correspondence or service calls concerning your appliance.

FOR YOUR SAFETY

If you smell gas:

1. Open windows.
2. Don't touch electrical switches.*
3. Extinguish any open flame.
4. Immediately call your gas supplier.

*Don't turn electric switches on or off because sparks may ignite the gas.

FOR YOUR SAFETY

Do not store or use gasoline or other flammable vapors and liquids in the vicinity of this or any other appliance.

IMPORTANT SAFETY INSTRUCTIONS

Read all instructions before using this appliance.

WARNING—To reduce the risk of fire, electric shock, or injury to persons when using your appliance, follow basic precautions, including the following:

- Use this appliance only for its intended purpose as described in this Use and Care Book.

- This appliance must be properly installed and located in accordance with the Installation Instructions before it is used. If you did not receive an Installation Instructions sheet with your appliance, you can obtain one by contacting the service location nearest you.

—Properly ground to conform with all governing codes and ordinances. Follow details in Installation Instructions.

—Locate where the temperature is above 50°F. (10°C.) for satisfactory operation of the control system. Do not install or store the appliance where it will be exposed to the weather.

—Connect to a properly rated, protected and sized power-supply circuit to avoid electrical overload.

—Exhausting to the outside is **STRONGLY RECOMMENDED** to prevent large amounts of moisture and lint from being blown into the room. Carefully follow the details in the Installation Instructions. If your appliance is *not* vented to the outside, see special instructions on page 25.

- Turn off water faucets when the washer is not in use to relieve pressure on hoses and valves, and to minimize leakage if a hose or valve should break or rupture.

- When disconnecting this appliance pull by the plug rather than the cord to avoid damage to the cord or junction of cord and plug.

Make sure that the cord is located so that it will not be stepped on, tripped over or otherwise subjected to damage or stress.

- Do not repair or replace any part of the appliance or attempt any servicing unless specifically recommended in this Use and Care Book or in published user-repair instructions that you understand and have the skills to carry out.

To minimize the possibility of injury:

- Do not mix chlorine bleach with ammonia or acids such as vinegar and/or rust remover. Mixing can produce a toxic gas which may cause death.

- Do not wash or dry articles that have been cleaned in, washed in, soaked in, or spotted with combustible or explosive substances (such as gasoline, degreasers, dry-cleaning solvents, kerosene, etc.) which may give off vapors that could ignite or explode.

Do not add these substances to the wash water, and do not use or store these substances on/or around your washer and dryer during operation.

- **HYDROGEN GAS is produced by the chemical action within your water heater and the gas can accumulate in the water heater and/or water pipes if hot water has not been used for a period of two weeks or longer. HYDROGEN GAS CAN BE EXPLOSIVE UNDER THESE CIRCUMSTANCES. So to prevent the possibility of damage or injury, if you have not used hot water for two weeks or more, or move into a residence in which the**

hot water system may not have been used for some time, turn on *all* hot water faucets and allow them to run for several minutes before using any electrical appliance which is connected to the hot water system. This will allow any hydrogen gas to escape. Since the gas is flammable, do not smoke or use an open flame or appliance during this process.

- Never reach into washer while it is moving. Before loading, unloading or adding clothes, push the cycle selector knob in, then wait until the machine has completely stopped before opening the lid.

- Never reach into the dryer while the drum is moving. Before loading, unloading or adding clothes, wait until the drum has completely stopped.

- Close supervision is necessary if this appliance is used by or near children. Do not allow children to play inside, on or with this appliance or any discarded appliance. Dispose of discarded appliances and shipping or packing materials properly. Before discarding a washer or dryer or removing them from service, remove the lid or door.

- Keep all laundry aids (such as detergents, bleaches, fabric softeners, etc.) out of the reach of children, preferably in a locked cabinet. Observe all warnings on container labels to avoid personal injury.

- Keep the floor around your appliances clean and dry to reduce the possibility of slipping.

(continued next page)

IMPORTANT SAFETY INSTRUCTIONS (continued)

- To minimize the possibility of electric shock, unplug this appliance from the power supply before attempting any maintenance or cleaning (except the removal and cleaning of the dryer lint filter).

NOTE: Pushing the washer cycle selector knob in or turning the dryer cycle selector to OFF does NOT disconnect the appliance from the power supply.

- **Do not tamper with controls.**
- Do not operate this appliance if it is damaged, malfunctioning, partially disassembled, or has missing or broken parts, including a damaged cord or plug.
- Never climb on or stand on the washer or dryer top.
- Do not wash or dry fiberglass articles in your appliance. Skin irritation could result from the remaining particles that may be picked up by clothing during subsequent use of the appliance.

To minimize the possibility of a fire hazard:

- Do not use heat to dry articles containing rubber, plastic, or similar materials (such as padded bras, tennis shoes, galoshes, bath mats, rugs, bibs, baby pants, plastic bags, etc.) as these materials may melt or burn. Also, some rubber materials, when heated, can under certain circumstances produce fire by spontaneous combustion.
- Garments labeled "Dry Away From Heat" (such as life jackets containing Kapok) must not be put in your dryer—fire hazard could result.

- Do not wash or dry articles that have been cleaned in, washed in, soaked in, or spotted with combustible or explosive substances (such as gasoline, degreasers, drycleaning solvents, kerosene, etc.) which may give off vapors that could ignite or explode. Do not add these substances to the wash water, and do not use or store these substances on/or around your appliance during operation.

- Any article on which you have used a cleaning solvent, or which contains flammable materials (such as cleaning cloths, mops, towels used in beauty salons, restaurants or barber shops, etc.) must not be placed in or near the dryer until all traces of these flammable liquids or solids and their fumes have been removed. There are many highly flammable items used in homes such as: acetone, denatured alcohol, gasoline, kerosene, some household cleaners, some spot removers, turpentine, waxes, wax removers and products containing petroleum distillates.

- Clean the dryer lint filter before each load to prevent lint accumulation inside the dryer or in the room. **DO NOT OPERATE THE DRYER WITHOUT THE LINT FILTER IN PLACE.**
- The interior of the machine and the exhaust duct connection inside the dryer should be cleaned periodically by a qualified individual.
- Exhaust duct (see installation instructions). Use only metal duct inside dryer or for exhausting dryer to the outside.

- Keep area around and underneath your appliance free from the accumulation of combustible materials, such as lint, paper, rags, chemicals, etc.

- Do not store items that may burn or melt (such as clothing, paper material, plastics or plastic containers, etc.) on top of the dryer during operation.

- The laundry process can reduce the flame retardancy of fabrics. To avoid such a result, the garment manufacturer's care instructions should be followed very carefully.

For washer operation

- Do not leave washer lid up during cycle. This will stop the spin action and prevent completion of the cycle.

Dryer-applied fabric softeners or anti-static conditioners

You may wish to soften your laundered fabrics or reduce the static electricity in them. We recommend you use either a fabric softener in the wash cycle, according to the manufacturer's instructions for those products, or try a dryer-added product for which the manufacturer gives written assurance on the package that their product can be safely used in your dryer.

Service or performance problems caused by the use of these products are the responsibility of the manufacturers of those products and are not covered by the warranty of this appliance.

SAVE THESE INSTRUCTIONS

How to sort the clothes

Washer

Sort by surface texture

Separate

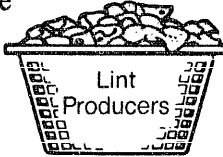

from



LINT PRODUCERS—such as terry toweling and chenille—give up lint. **LINT COLLECTORS**—such as man-made fibers and napped fabrics like velveteen and corduroy—attract lint, and must be dried separately.

For more information about lint control, see page 21.

Sort by fabric

Separate

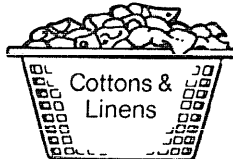

from



from

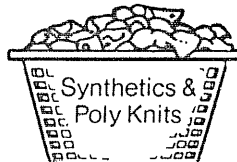

from

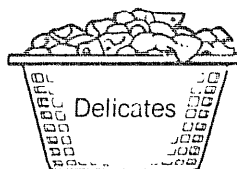

Sort by color

Separate

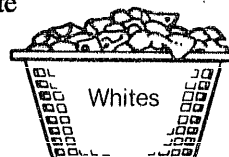

from

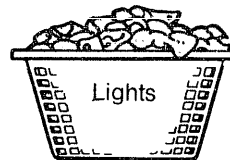

from

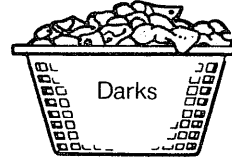

from

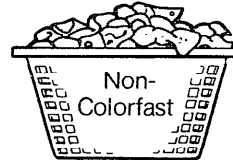

Sort by soil

Separate



from

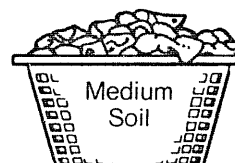

from

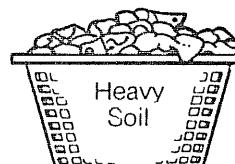

Dryer

Normally, if you sort clothes correctly for washing, you will have properly sorted drying loads. Here's an additional suggestion for good dryer load make up:

Sort by weight

Separate



from

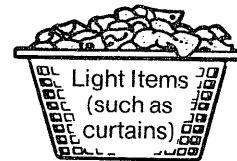

It pays to check and pre-treat before washing.

- Empty pockets, brush out cuffs, zip zippers, snap snaps, hooks and buttons.
- Do any necessary mending—rips, hems, tears.
- Check all items for areas of heavy soil or stain and remove stains.

For Stain Removal Guide, see page 17.

- Turn Poly Knits inside-out to minimize fabric surface damage.

Soaking—a good way to loosen deep soils and stains.

A thorough soaking with detergent or special soaking agent is another way to remove heavy soils, embedded dirt and even some stains. For detailed information on how to soak in your washer, see page 6.

For information on soaking agents, see page 15.

How to operate your clothes washer

WARNING—To reduce the risk of fire, electric shock, or injury to persons, read the **IMPORTANT SAFETY INSTRUCTIONS** before operating this appliance.

Load the washer properly

- **Add accurately-measured detergent to empty tub.** See pages 11 through 13.

- **Load clothes loosely.** Dry clothes level should be no higher than the top row of circular holes in the wash tub. Do not put clothes on top of the agitator or wind them around it. For best results, mix large items with small ones. When washing a single heavy item, such as a shag rug or bedspread, add one or two other pieces to balance the load. Large items should be no more than one-half of the total load.

Here is a typical full load:

2 double sheets	2 long-sleeve shirts
2 pair trousers	2 standard pillowcases

- **To bleach the load,** measure liquid bleach according to directions on container. After washer has filled and agitated for several minutes, add diluted bleach to the wash water.

How to use powdered bleach, fabric softeners and other laundry products is explained on page 15.

- **Close lid.** Washer will fill and agitate but will not spin with lid open. This washer has a Safety Lid Lock. As a safety measure the lid will be automatically locked during the spin portion of each cycle. The lid will automatically unlock about 30 seconds after the end of the spin cycle. To open lid during spin cycle, push Cycle Selector IN and wait for lid lock to release, about 30 seconds, before opening.

For your personal safety, never reach into washer while parts are moving. Always stop washer to load, unload, add forgotten items or additional laundry aids.

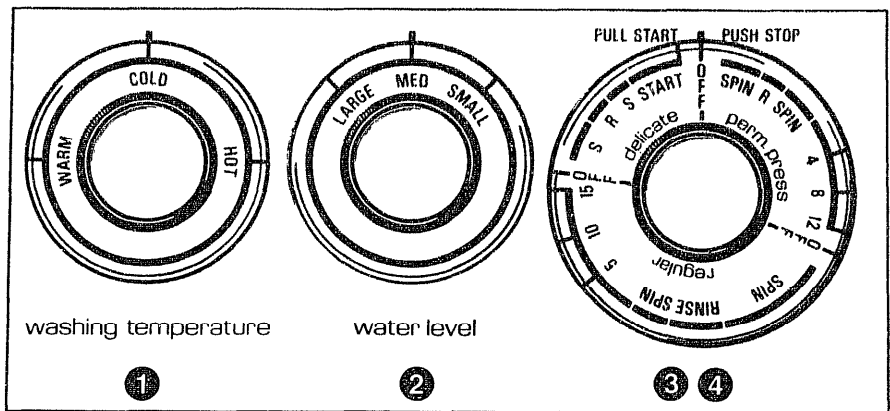

Set the controls

See the Controls Setting Guide on pages 8 and 9.

① Select Washing Temperature.

Cold rinse will be automatically provided with all cycles.

② Select Water Level.

SMALL: Washer is less than 1/3 full of clothes.

MEDIUM: Between 1/3 and 2/3 full.

LARGE: Over 2/3 full of clothes.

③ **Push Cycle Selector in** and turn clockwise to your selected wash cycle.

④ **Pull Cycle Selector out** to start the cycle.

Note: If you have selected the Perm Press or Regular cycle and wish to change cycle setting after washer has started, push Cycle Selector in and wait for washer to stop. Then reset to the new position. Setting can be changed at any time during the Perm Press or Regular cycle.

Self-cleaning lint filter. The lint filter needs no attention from you. Lint collected during washing and rinsing of clothes is automatically flushed down the drain.

How to soak in the washer

Set Washing Temperature control. Add detergent or soak agent. Turn Cycle Selector to desired cycle. Start the washer. After washer fills and begins to agitate, push in the Cycle Selector to stop washer. Allow to soak for as long as desired. After desired soak, turn to the last Spin. Pull out the Cycle Selector to complete the cycle.

Delicate cycle

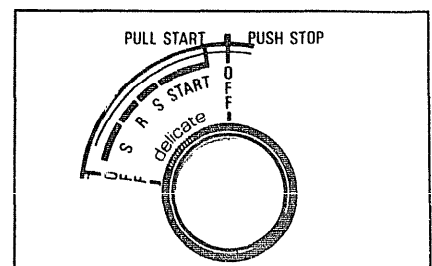

To get the full benefit of the Delicate Cycle, always set it at the beginning of the cycle. During wash, the Delicate Cycle alternates between agitation and pauses to protect delicate clothes.

How to operate your dryer

WARNING—To reduce the risk of fire, electric shock, or injury to persons, read the **IMPORTANT SAFETY INSTRUCTIONS** before operating this appliance.

Load the dryer properly

- Load sorted clothes into dryer. See page 5.
- Clean lint filter before each load.

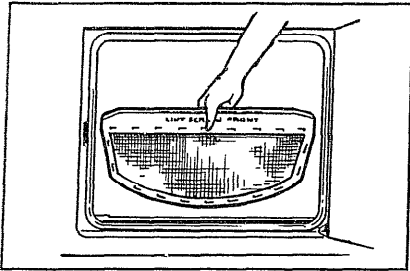

Remove the lint filter by pulling straight out. Wipe all accumulated lint from screen. Occasionally wash filter using soap and warm water. Rub lightly, rinse and dry thoroughly. This will help remove all fabric softener buildup.

Do not use dryer-applied fabric softeners unless you follow these lint cleaning instructions.

Do not operate dryer without lint filter in place.

- Close door. Door must be closed before dryer will operate.

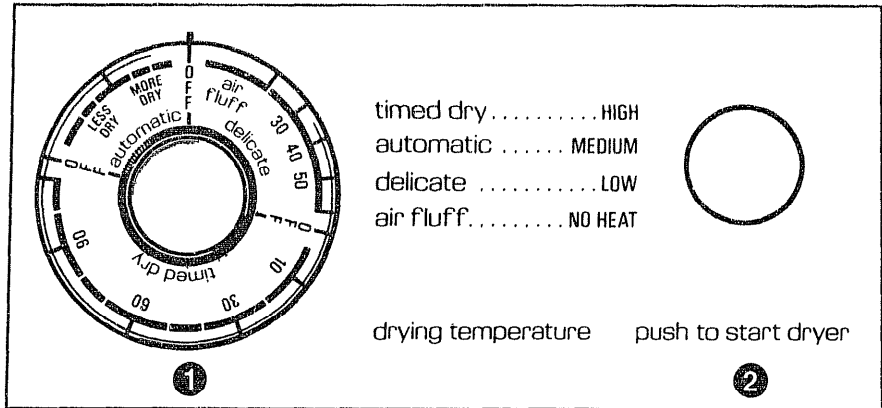

Set the controls

See Controls Setting Guide on pages 8 and 9.

① Turn Cycle Selector clockwise to desired cycle and select correct drying time for load type.

② Press Push to Start button. (Opening door during operation stops dryer. To re-start, close door and press Push to Start button again.)

End-of-cycle signal

Buzzer sounds briefly to alert you when cycle is completed.

Polyester Knits & Perm Press Drying Tips

- **Do not overload**—Garments being dried or dewrinkled should tumble freely.
- **Remove clothes immediately**—To help prevent wrinkling, remove from the dryer immediately at the end of the drying cycles.
- **Place on hangers**—Permanent Press and Polyester Knit garments look best if placed on hangers after drying.

How Timed and Automatic Drying Differ

Automatic drying—The Automatic Dry Control system continually senses air temperature in dryer drum. Wet laundry keeps this air cool. When drum air is warm enough, heat turns off. When the air cools, heat turns back on. This on and off cycling may happen a number of times (depending on the fabric, load size and Cycle Selector setting). The Cycle Selector advances (when the heat is off) until it automatically turns dryer off.

Timed drying—You select the number of minutes you wish the dryer to run and it turns off at the end of this time period.

Dryness Selections Guide for the Automatic Cycle

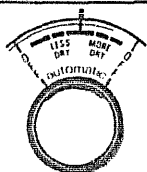
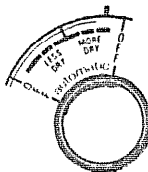
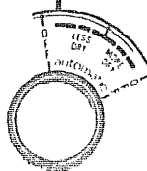
Set to Middle Position		<ul style="list-style-type: none"> • For most normal loads.
Set toward MORE DRY		<ul style="list-style-type: none"> • For loads that include heavyweight fabrics. • If you desire to remove more moisture.
Set toward LESS DRY		<ul style="list-style-type: none"> • For lightweight fabric loads. • For very small loads. (Add two or more similar articles, even if dry, to assist tumbling.) • If you desire to remove less moisture.

Controls Setting Guide for different fabrics and loads

Washer				
Type of Load	Wash Water Temperature	Wash Cycle	Wash Cycle Setting	Dry Cycle
Baby Clothes				
Plastic-lined items	Warm	Delicate*	Set at START.	Air Fluff (No Heat)
Diapers	Hot	Regular	See #1 below.	Timed Dry (High Heat)
Man-made fabrics**				
Mixed cottons	Warm	Perm Press	See #2 below.	Automatic Dry (Medium Heat)
Bedspreads	Follow Label Directions.			
Blankets				
Electric	Warm	Delicate*	Set at START.	Delicate (Low Heat)
Man-made**	Warm	Delicate*	Set at START.	Delicate (Low Heat)
Woolen	Warm	Delicate*	Set at START.	Delicate (Low Heat)
Cottons & Linens				
Colorfast/White	Hot	Regular	See #1 below.	Timed Dry (High Heat)
Non-Colorfast	Warm			
Curtains				
Cotton	Hot or Warm	Regular	See #1 below.	Timed Dry (High Heat)
Man-made** Sheers	Warm	Delicate*	Set at START.	Delicate (Low Heat)
Permanent Press	Warm	Perm Press	See #2 below.	Automatic Dry (Medium Heat)
Delicates				
Lingerie, Knits	Warm	Delicate*	Set at START.	Delicate (Low Heat)
Foundation Garments†	Warm	Delicate*	Set at START.	Delicate (Low Heat)
Glass Fiber	Do not wash glass fiber in the washer.			
Permanent Press				
Curtains	Warm	Perm Press	See #2 below.	Automatic Dry (Medium Heat)
Draperies	Warm	Delicate*	Set at START.	Automatic Dry (Medium Heat)
Dresses, sportswear	Warm	Perm Press	See #2 below.	Automatic Dry (Medium Heat)
Heavy slacks	Hot	Perm Press	See #2 below.	Automatic Dry (Medium Heat)
Knits, man-made**	Warm	Delicate*	Set at START.	Delicate (Low Heat)
Lingerie	Warm	Delicate*	Set at START.	Delicate (Low Heat)
Sheets & pillowcases	Hot	Perm Press	See #2 below.	Automatic Dry (Medium Heat)
White shirts, blouses	Hot	Perm Press	See #2 below.	Automatic Dry (Medium Heat)
Work clothes	Hot	Perm Press	See #2 below.	Automatic Dry (Medium Heat)
Plastic	Warm	Delicate*	Set at START.	Air Fluff (No Heat)
Quilted Items	Follow Label Directions.			
Swimsuits	Follow Label Directions.			
Sweaters, man-made fabrics**	Warm	Delicate*	Set at START.	Delicate (Low Heat)
Synthetic Sheets	Warm	Delicate*	Set at START.	Delicate (Low Heat)
Washable Woolens	Warm	Delicate*	Set at START.	Delicate (Low Heat)
Work Clothes	Hot	Regular	See #1 below.	Timed Dry (High Heat)

#1 Regular Cycle: 10-15 minutes for Heavy soil, 5-10 for Normal soil, up to 5 for Light soil.

#2 Perm Press Cycle: 12 minutes for Heavy soil, 4-8 for Normal soil, up to 4 for Light soil.

*Delicate cycle alternates between pauses and agitation during wash.

**Man-made fibers (synthetics) such as polyester, nylon and acrylics must be dried using the Delicate (low heat) Cycle. If you mix various types of fabrics in your drying load, set the controls for the lightest weight fabrics and remove when dry. Then reset the control for the remaining fabrics.

†Never dry foam rubber or similarly textured, rubber-like materials in the dryer except on AIR FLUFF (no heat). Fire hazard may result.

Save and refer to Garment Manufacturers' Care Labels

For more information on care labeling, send for "What's New About CARE LABELS!"

For sale by the Superintendent of Documents, U.S. Government Printing Office, Washington, D.C. 20402.

Dryer		
Dry Cycle Setting	Special Instructions	
Up to 20	Plastic-lined pants, bibs, pads, crib sheets may be washed with regular load but should be dried separately.	
45-60	Rinse at once, soak in diaper pail with solution of cold water and borax (1/4 teaspoons to gallon). Soak before washing with a presoak product. Use warm water.	
25-40		
Midpoint	Pretreat heavily soiled areas; brush on a little liquid detergent, or wet area and rub in detergent. Use Warm Soak for oil and juice stains; cold for egg, milk and cereal stains.	
	Follow Label Directions.	
85-95	Shake out excess dust. Remove stains. Pretreat heavily soiled areas with detergent. Wash one large or two small blankets at a time.	
65-95		
15	See "Washable Woolens" instructions below.	
Full loads 65-75 Small loads 35-45		
25-35	If badly sun-weakened, even hand washing will cause tearing. Be sure colors are fast and fabric is washable. Remove hooks and non-washable trim. Use Warm Soak if heavily soiled.	
5-10		
Less Dry		
20-30		
30-40	Frequent washing lengthens life, helps retain shape. Remove non-washable trim. Close zippers; fasten hooks. Do not dry glass fiber in the dryer.	
Less Dry	If badly sun-weakened, even hand washing will cause tearing. Be sure colors are fast and fabric is washable. Remove hooks and non-washable trim. Use Warm Soak if heavily soiled.	
Midpoint		
Midpoint		
More Dry	Turn slacks and dark items inside out to prevent whitening of seams and creases.	
25-35		
20-30		
Midpoint	Use Warm Soak for pillowcases stained with hair oil.	
Midpoint	Pretreat collars and cuffs with liquid laundry detergent.	
More Dry	See "Work Clothes" instructions below.	
15-20	Some plastics will tear if machine washed. Place small items in mesh bag for washing. If shower curtains are soap-streaked, add Calgon brand to wash water; don't use detergent.	
	Follow Label Directions.	
	Follow Label Directions.	
40-55	Pretreat around neckline. Follow manufacturer's recommendations.	
15-20		
5-15	As a general rule, if wool can be hand washed, it can be "washed" by soaking in the washer. A liquid detergent is preferred because it dissolves faster in a soak than a granulated detergent. Pretreat woolens with liquid detergent. Never use chlorine bleach.	
65-85	Pretreat heavily soiled areas by rubbing in liquid laundry detergent. Let stand 30 to 60 minutes. If clothes are heavily soiled, use Warm Soak for greasy and oily soil. Cold Soak for flour, dust, blood-stained garments. Use 1/4 to 1/2 cup liquid laundry detergent in SOAK; 1/2 to 1 cup in Wash.	

DO NOT tumble dry jackets or pillows containing Kapok. Fire hazard may result.

NOTE: The Cycle Selector settings indicated here are to be used as a guide. You may find that best results are obtained for some of your fabrics by setting the Cycle Selector to either side of the recommended settings.

Energy-saving tips

Washer

If your clothes and household items don't look clean and fresh after washing, you will probably re-wash them... and that means you'll waste energy. Remember to sort your clothes carefully, and load them properly, select correct cycles, use enough detergent and *choose a water temperature warm enough to release and get rid of soil.*

- Use **HOT** wash—140°F. (60°C.)—on a regular basis *only* when washing heavily soiled articles—such as work and play clothes.
- Under normal soil conditions, wash in water above 80°F. (27°C.). This generally means using the **WARM** wash temperature setting on your washer—temperatures approximately 95°F. (35°C.). If you notice that soil has accumulated after several consecutive washings, use **HOT** wash occasionally, if safe for fabrics.
- Always rinse in **COLD** water. The temperature of the rinse does not affect cleaning.
- Try to wash less often. Save articles of the same type of fabric until you have a full load.
- If you must wash smaller loads, adjust the amount of water. Small loads should have lower water levels.
- Wash in off-peak utility hours. Your local utility can tell you which are the off-peak hours.

Dryer

- Sort clothes by weight so you won't have to run an extra cycle for one or two heavier, slower-drying items.
- Do not overload dryer. The drum should be no more than half full of wet articles. For efficient drying, clothes need to tumble freely. Overloading prolongs drying time and produces uneven drying.
- Use Automatic Drying Cycle whenever possible to help prevent overdrying and save energy.
- To help prevent ironing, remove garments immediately at end of drying cycle and place on hangers.
- Dry your clothes in consecutive loads. Using a "warm" dryer will save energy.
- Clean lint filter each time you dry.
- Clean dryer exhaust ducting at least once a year. A partially clogged exhaust can lengthen drying time.

Factors to consider in selecting detergents and soap

Products	Advantages	Disadvantages
<p>Phosphate— Powdered Detergents</p>	<p>Perform well in hard or soft water</p> <p>Wash all types of fabrics well. Can be used in hot, warm, or cold water.</p>	<p>Are not available in some areas.</p>
<p>Non-Phosphate— Powdered Detergents</p>	<p>Perform satisfactorily in soft or moderately hard water.</p> <p>In some areas only non-phosphate products are available.</p>	<p>Generally do not clean well in hard water.</p> <p>May be difficult to dissolve, especially in cold water.</p> <p>Should <i>not</i> be used in cool water.</p> <p>Those containing sodium carbonate as an ingredient may cause harmful limestone deposits on clothes and washer when combined with hard water. (See page 12.)</p>
<p>Liquid Detergents</p>	<p>Perform well in soft water.</p> <p>Offer better performance in hard water than powdered non-phosphate types.</p> <p>Cleans synthetics and fabric blends well.</p> <p>Are excellent as concentrates for removing spots.</p> <p>Completely dissolve even in cold water.</p>	<p>May not perform as well as powdered phosphate products when diluted in wash water.</p>
<p>Soaps</p>	<p>Perform well in soft water.</p>	<p>Generally do not clean well in medium-hard or hard water.</p> <p>May combine with water hardness minerals to form sticky soap curd.</p>

The results of continued use of carbonate detergents

Is your water hard? If it is, and if you use a carbonate type non-phosphate detergent, you will most probably notice limestone* deposits on your clothes and

washer surfaces. The hardness of your water and your washing frequency will determine how rapidly the limestone will build up. If your water is VERY HARD

(11 or more grains) and if you wash just a few loads a week, you may see limestone buildups in just a few months.

Effects on clothes

Although limestone buildup occurs more rapidly on cotton, it will eventually affect various fabrics in the following ways:

- Gives a stiff, harsh, rough feel to fabrics such as toweling.
- Causes colors to fade and become dull and dingy.
- Causes graying of fabrics.
- Leaves a white, powdery residue on dark-colored items.
- Causes spot-fading of bright colors as a result of direct contact with detergent.
- Reduces wrinkle-resistance of permanent press fabrics.
- Destroys effectiveness of flame-retardant finishes on cottons such as children's sleepwear.
- Increases fabric wear because of the scrubbing action between limestone deposits on the fabrics during washer agitation.

Effects on washer

- Unsightly buildup on all washer surfaces exposed to the wash solution.
- Mat-like, crusty formations caused by lint adhering to the sticky limestone deposits.
- Increased service calls because of limestone deposits in the pump, recirculation water hoses, filters and other washer parts.
- Reduced useful life of washer.

Recommended methods to reduce limestone buildups

- Use a powdered phosphate detergent or a liquid detergent if these are available in your area.
- Install a home water softener. This will significantly reduce limestone buildup.
- Use a packaged non-precipitating water softener, such as Calgon brand with phosphate.

Good washing practices may delay limestone damage to clothes

The following recommendations will temporarily delay the effects of limestone on your clothes. These are generally good washing practices and will give better soil removal whether or not you have hard water or use carbonate detergent.

- Use hotter wash water, for example up to 150°F. for cottons. This also improves oily-soil removal.
- If you wash in cooler water to save energy, use more detergent to promote better washing. Also be sure to use bleach on bleachable fabrics. Use hot water whenever possible.
- Add detergent and allow washer to fill and agitate for three or four minutes to dissolve detergent before adding clothes.
- Increase amount of detergent. See guide on opposite page for recommended detergent amounts in relation to water hardness.

- Increase use of bleaches, presoaks, packaged water conditioners, prewash soil and stain removers to help in removing stubborn soils and stains.
- Use greater care in sorting loads. Wash very dirty loads separately and increase detergent to help keep dirt from redepositing on less soiled items. Wash delicate items separately to prevent damage from heavy, sturdy clothes.
- Wash smaller loads to increase cleaning action of washer.
- Use fabric softener to counteract stiffness or harshness in clothes.

How to partially restore clothes

Once clothes have developed deposits, they may be partially restored by soaking in a solution of two cups of vinegar in one gallon of hot tap water for 15 minutes. **USE A PLASTIC CONTAINER.** Then wash clothes in the washer using detergent.

CAUTIONS:

- Vinegar soak solution may reduce the wrinkle-resistance of permanent press fabrics.
- Vinegar soak may damage the dyes in some fabrics.

*LIMESTONE—technically called CALCIUM CARBONATE—is caused by the reaction of the calcium in the hard water with the sodium carbonate in the detergent.

How much detergent should you use?

The use of a sufficient amount of detergent is one of the most important things you can do to make sure your wash comes out clean.

Amount required varies according to:

1. Water hardness
2. Amount of soil
3. Size of load
4. Type of detergent
5. Wash temperature

Use more detergent if you have...

1. Hard water
2. Large loads
3. Greasy or oily soils
4. Lower wash temperature
5. Low phosphate detergent.

If the recommended amount of detergent produces too many suds, switch to a low sudsing detergent brand, and follow instructions on package. Excess suds are not necessary to get clothes clean and can hamper wash action.

Using too little detergent is a common cause of laundry problems. Always measure detergent in a standard measuring cup.

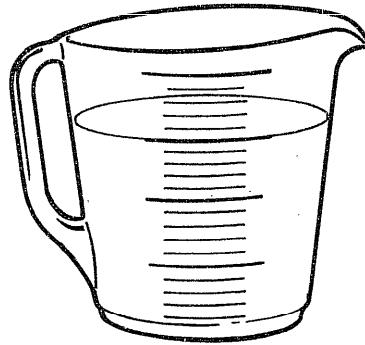

How to use granular or powdered detergent.

For best results, put the detergent in the washer before the clothes have been loaded.

If your detergent doesn't dissolve well, pre-dissolve the detergent in hot water and put it in the washer before clothes are added.

Recommended amount of detergent for average soil load

	Water Hardness	Water Level Setting		
		LARGE	MEDIUM	SMALL
POWDERED DETERGENTS	VERY HARD 10-20 Gr.	1½ cups	1¼ cups	¾ cup
	HARD 4-10 Gr.	1¼ cups	1 cup	½ cup
	SOFT 0-4 Gr.	¾ cup	½ cup	¼ cup
CONCENTRATES AND LIQUIDS	0-20 Grains	FOLLOW PACKAGE DIRECTIONS		

1. Use recommended amount of detergent for your load and water hardness as shown in guide.
2. When using other detergent types—low and normal suds, powders, liquids, non-phosphate powders—follow recommendations on package.
3. For hard water treatment, see page 14.

Hard water

Before you can decide what to do about hard water, you need to know if you have it and, if so, how hard it is.

- If you live in a municipal area, contact your water company.
- If you live in a rural area, or in some suburban areas, contact your county agent.

The answer will be “you have ‘so many grains’ per gallon” and means this:

0 to 3 grains per gallon—SOFT

4 to 10 grains—HARD

11 to 19 grains—VERY HARD

20 grains and over—

EXTREMELY HARD

If your water is SOFT, you have no problem. You can use soap or detergent as you prefer and forget all about hard water. If you have HARD water—less than 10 grains—and you use phosphate detergent, you also have no problem.

But, if you have more than 10 grains, you will need to soften your water with either...

1. An installed water softener in your home, or
2. The use of a packaged water softener.

For information on water softeners, see chart below.

Add this much water softener with a full water level

Grains of hardness	0—10	10—15	15—20	20—25	25—30	over 30
When using with detergent	0	¼ cup (60 ml)	½ cup (120 ml)	¾ cup (160 ml)	1 cup (240 ml)	1 cup plus 1 tablespoon for every 5 grains above 30 (240 ml plus 15 ml for each extra 5 grains)
When using with soap	½ cup (80 ml)	¾ cup (160 ml)	¾ cup (180 ml)	1 cup (240 ml)	1½ cups (360 ml)	1¼ cups plus 1 tablespoon for every 5 grains above 30 (300 ml plus 15 ml for each extra 5 grains)

Other laundry products—

Laundry Product & Type	How to use it	Special Instructions
BLEACH Chlorine liquid such as Clorox™ brand	Dilute one cup bleach with at least one quart (0.96 liter) water and add after wash action has started and detergent is dissolved.	1) Do not pour undiluted liquid chlorine bleach directly into washer or on dry clothes. 2) Some of today's washable fabrics should not be chlorine bleached such as: 100% cotton flame-retardant children's sleepwear, silk, wool, mohair, spandex, leather, or non-fast colors. Dilute bleach before using on any fabric. 3) Check manufacturer's hang tags for special instructions.
Non-chlorine such as Clorox 2™ brand	Follow package directions. Put bleach into washer with detergent.	1) May be used on all kinds of fabrics. 2) Is most effective in hot water.
FABRIC SOFTENERS Rinse additive such as Downy™ brand	Mix recommended amount with one cup (240 ml) water and add at start of rinse cycle.	1) Helps make clothes fluffy and soft. 2) Reduces static electricity. 3) Use carefully. Too much may cause staining on some clothes. 4) Do not use with other laundry additives. 5) Do not pour directly on the clothes.
Wash additive such as Rain Barrel™ brand	Follow package directions. Add during wash cycle.	Use carefully. Too much may cause staining on some clothes.
SANITIZER Chlorine bleach, such as Clorox™ brand	Use in case of infection and contagious disease. See under Bleach above.	Guards against infection by killing most bacteria and viruses*
WATER SOFTENER Non-Precipitating such as Calgon™ brand	Follow package directions. Add at start of wash cycle.	Suspends hardness minerals in solution, keeping water clear.
Precipitating such as Borax™ brand	Follow package directions. Use with detergent or soap in wash cycle.	Combines with water hardness minerals to form precipitate which gives cloudy or milky appearance to water.
SOAK AGENT Such as Biz™ brand	Follow package directions for grass, perspiration, egg, baby formula, blood, mud and other stains.	Do not use with chlorine bleach as chlorine stops the stain removal action of enzyme soak agents.
PRETREATING STAIN AND SPOT REMOVERS Such as Spray 'n Wash™ and K2R™ brands	Follow package directions. Treat only heavily soiled areas. Check garment's hang tag for instructions.	CAUTION: Control panel and finishes may be damaged by some laundry pretreatment soil and stain remover products if such products are sprayed on or have direct contact with the washer and/or dryer. Apply these pretreatment products away from the appliance. The fabric may then be washed normally. Damage to your appliance caused by pretreatment products is not covered by your warranty.
TINTS AND DYES Powdered such as Rit™ and Tintex™ brands	Follow package directions. NOTE: Tinted garments may not be colorfast. Wash separately.	Clean washer to avoid discoloration of next load. Go through complete cycle (5-min. wash) using hot water, 1/2 cup (120 ml) detergent, 1 cup (240 ml) bleach. Wipe exterior parts. Caution: Tinting may discolor plastic in washer. Subsequent washings will reduce discoloration but may never eliminate it.

*For more information on sanitizers, send for Government Bulletin #57B, "Sanitation in Home Laundering."
 Write to: Consumer Information Center, Pueblo, Colorado 81009.

How to remove stains

1. Try to remove stains as soon as possible. The fresher the stain, the easier it is to remove.

2. Before attempting to remove any stain, take these steps:

- Find the fabric and the finish in the guide on the next page, and use only recommended methods.
- Check the care label instructions that came with the garment.
- Test stain removal product on a hidden inside seam or on a sample of the material.
- Avoid use of hot water on unknown stain. It can set some stains.

3. Follow stain removal with a thorough rinsing.

4. Wash with recommended amount of soap or detergent.

Stain removal hint— Using chlorine bleach for white and bleachable fabrics.

Mix 1/4 cup (60 ml) chlorine bleach with one gallon (3.8 liter) of cool water—approximately 80°F. (27°C.)—in a sink or pan. Soak stained area for 5 minutes and launder in washer.

The Case of the “Invisible” Stain.

Food or cooking oils on your synthetic garments may cause stains which are virtually invisible and which you may not notice as you put your clothes into the washer.

If these stains are not completely removed in the wash, the oily spots may pick up dirt from the wash water. Then they will become very visible and you may think they were caused by the wash cycle itself.

Once these spots become visible, how can you remove them?

- Rub in undiluted liquid detergent and let stand 30 minutes.
- Re-wash using hottest water the fabric can stand.

How can you prevent these “After-You-Wash” stains?

- Increase the amount of detergent normally used.
- Increase water temperature where fabric will permit.
- Wash synthetic garments more often.

See next page for Stain Removal Guide.

For more complete information on stain removal, request government bulletin, “Removing Stains From Fabrics,” 054D. To obtain a copy write to: Consumer Information Center, Pueblo, Colorado 81009. Available at low cost.

Important Cautions

• NEVER PUT HIGHLY VOLATILE SUBSTANCES LIKE GASOLINE, KEROSENE, OR NAPHTHA INTO A WASHER OR DRYER.

NEVER PUT WASHABLE ARTICLES THAT HAVE GASOLINE, KEROSENE, NAPHTHA OR OTHER HIGHLY VOLATILE SUBSTANCES ON THEM IN A WASHER OR DRYER. FAILURE TO COMPLY WITH THESE WARNINGS COULD RESULT IN A FIRE, EXPLOSION OR SERIOUS BODILY INJURY. All items with volatile substances on them should be **HAND** washed thoroughly with a detergent so that no trace of volatile substance remains. The articles can then be machine washed. Only after thorough hand washing and machine washing should the article be placed in the dryer.

Do not use these substances around your washer and/or dryer during operation.

*Because cleaning fluids tend to be toxic, be sure you are in a well ventilated room when using them. No cleaning fluid should be used unless user is familiar with the limitations and required cautions (usually printed on label). Use extreme caution with flammable compounds. Under no circumstances should fabrics containing flammable materials (waxes, cleaning fluids, etc.) be washed in washer.

**Do not mix chlorine bleach with ammonia or acids such as vinegar and/or rust remover. Mixing can produce a toxic gas which may cause death.

Stain removal guide Save and refer to Garment Manufacturers' Care Instructions.

Stain	White and Bleachable Fabrics See Washing Guide, Bleach on page 15	Other Washable Fabrics
Adhesives (Chewing Gum, etc.)	Rub with ice or immerse in very cold water. <i>Use dull tool to carefully scrape off as much adhesive or gum as possible.</i> Sponge with a safe dry cleaning fluid,* then launder.	Same as white and bleachable fabrics.
Anti-perspirants, Deodorants	Apply undiluted liquid detergent. Rinse. If stain remains, bleach according to Stain Removal Hint on opposite page. If color has changed, you may be able to restore it by sponging with ammonia.** Rinse thoroughly.	Same as white and bleachable fabrics except use non-chlorine bleach.
Blood	Soak in cold water, then launder in warm water. If stain remains, bleach according to Stain Removal Hint on opposite page, launder.	Sponge or soak in cool water, then launder.
Chocolate, Cream, Ice Cream and Milk	Soak in cold water. Treat stain with a safe dry cleaning fluid*; Apply undiluted liquid detergent, launder, dry. Bleach according to Stain Removal Hint on opposite page, launder and dry.	Soak in cold water. Sponge with a safe dry cleaning fluid.* Apply undiluted liquid detergent. Launder in warm water.
Coffee and Tea	Without cream: Bleach according to Stain Removal Hint on opposite page. Launder. With cream; Follow guide directions for cream.	Sponge with warm water. If stain remains, apply warm glycerine, let stand 30 minutes and rinse well, or sponge with a safe dry cleaning fluid.* Launder.
Cosmetics: Eye Shadow, Lipstick, Mascara, Liquid or Pancake Makeup, Rouge, Powder; Crayon; Grease, Oil, Tar, Cod Liver Oil.	Treat stain with safe dry cleaning fluid.* Apply undiluted liquid detergent; launder and dry. Bleach according to Stain Removal Hint on opposite page.	Sponge with a safe dry cleaning fluid.* Then launder in warm detergent water.
Fresh Fruit, Fruit Juices, Wine, Vegetables, or Food Coloring	Soak stain in cool water. If stain remains, bleach according to Stain Removal Hint on opposite page, launder.	Sponge with warm water. Bleach remaining stain with non-chlorine bleach.
Grass, Foliage, Flowers, Mildew, Scorch	Apply undiluted liquid detergent. Launder. (Treat mildew spots while they are fresh, before mold has a chance to weaken fabric.) If either type stain remains, bleach according to Stain Removal Hint on opposite page, launder. (Severe scorch cannot be removed.)	Sponge with warm water. Apply <i>undiluted liquid detergent</i> . Bleach remaining stain with non-chlorine bleach, then launder. Old mildew stains can seldom be removed. Scorch can seldom be removed.
Ink, Ballpoint	Fresh stains: Place stain face down on an absorbent towel and sponge with dry cleaning fluid,* or use spray cleaner. Apply undiluted liquid detergent. Old stains; bleach according to Stain Removal Hint on opposite page.	Same as white and bleachable fabrics except launder using non-chlorine bleach.
Paint and Varnish	Soften with oil, lard or Vaseline, then sponge with turpentine or banana oil. Launder in warm water.	Same as white and bleachable fabrics.
Perspiration	Apply undiluted liquid detergent and launder in warm water. If color has changed you may be able to restore it by treating with ammonia or vinegar.** If any stain remains, treat with safe dry cleaning fluid* or bleach according to Stain Removal Hint on opposite page, launder and dry.	Launder in warm water. Rinse well. Bleach with non-chlorine bleach.
Rust	Apply rust remover:** using manufacturer's directions. Rinse and launder.	Same as white and bleachable fabrics.



Questions? Use This Problem Solver

PROBLEM	POSSIBLE CAUSE AND REMEDY
WASHER OR DRYER WON'T START	<ul style="list-style-type: none">• Make sure controls are properly set and washer cycle selector is pulled out or dryer START button is pushed.• Appliance unplugged. Make sure cord is firmly plugged into electrical outlet.• No power to appliance. Check fuses and circuit breakers to make sure appliance is getting current.• Dryer door is open. Dryer will not run with door open. Make sure washer lid is closed. Washer will fill but will not spin with lid open.• Make sure both hot and cold faucets are turned on.
WON'T DRAIN	<ul style="list-style-type: none">• Kinked or pinched hose. Check and correct.• Top of drain outlet should be less than 8 feet above the floor.
WATER LEAKS	<ul style="list-style-type: none">• Make sure hose connections are tight at faucets.• Make sure end of drain hose is correctly inserted into and secured to drain facility.
WASHER WON'T SPIN AND COMPLETE CYCLE	<ul style="list-style-type: none">• Lid not closed. Washer will not progress through spin cycle with lid up. Make sure lid is closed. Lid will be automatically locked during spin portion for safety.
CLOTHES ARE ABNORMALLY WET AFTER SPIN	<ul style="list-style-type: none">• Load may have been excessively out of balance. Redistribute clothes and rerun through final spin.
APPLIANCE IS NOISY	<ul style="list-style-type: none">• Metallic "clicks" heard as timer advances during operation are normal.• Uneven floor. Make sure appliance is level and firm to floor.• Heavily unbalanced loads can cause the washer to vibrate excessively during spin, and may cause it to move from its original position. In extreme cases, (usually occurs when washing a single, heavy item or a small load when water level is set higher than necessary) the spin basket may strike the outer tub, creating a loud but harmless noise. To correct, open the lid and redistribute the load evenly about the wash basket. Close the lid and restart.
WATER DOES NOT ENTER OR ENTERS SLOWLY	<ul style="list-style-type: none">• Faucets turned off. Make sure faucets are on and adjusted correctly.• Hoses kinked. Check and correct.• Clogged screen in water valve. Unscrew fill hose from washer and clean screen if necessary. When reassembling, make hand tight plus 1/3 turn with pliers.

PROBLEM	POSSIBLE CAUSE AND REMEDY
WATER TEMPERATURE INCORRECT	<ul style="list-style-type: none"> • Faucets not adjusted to give desired temperature. Readjust them. • Household water heater not set to deliver correct temperature—140° to 150°F. (60° to 66°C.). Reset it. • Water valve screens may be stopped up. Remove inlet hoses from water valve. Clean the screens and reinstall the hoses. • Make sure selector controls are properly set. • Make sure hoses are connected to correct faucets—hot to hot, cold to cold.
WASHER PAUSES IN CYCLE	<ul style="list-style-type: none"> • Washer normally pauses about 1/2 minute in progressing from one portion of its cycle to the next. • Alternate pauses in the agitation are normal in the delicate wash cycle. Agitation will resume in 1-2 minutes. • The brief pause in the final spin of each cycle is normal operation for this washer.
GREASY OR OILY STAINS ON LAUNDERED GARMENTS	<p>These are sometimes called “Invisible Stains” because you may not notice them before washing clothes. However, if oily soils are not completely removed in wash cycle, the oily spots may pick up dirt from the wash water. The spots will then be very visible. They are <i>not</i> caused by the washer. Wash synthetic garments as soon as possible after wearing. Use more detergent than normal and hottest water fabric can stand. If spots appear, rub in undiluted liquid detergent, let stand 30 minutes and rewash with extra detergent using hottest water fabric can stand.</p>
YELLOWED CLOTHES	<ul style="list-style-type: none"> • Incomplete removal of body soil due to constant use of insufficient detergent. Check hem of T-shirt or pillow case. If they are white and center is yellow, it contains body oil. Restore whiteness following procedures on “Grayed Clothes,” page 20. • Chlorine bleach may yellow some fabrics with resin finishes. Use oxygen bleach (such as Clorox 2 brand). Refer to garment manufacturers’ care instructions. Restore color using color remover (such as Rit or Tintex brands), follow package directions. • Iron or manganese in water may cause overall yellowing or yellow spots. <ol style="list-style-type: none"> 1. Use extra detergent plus a non-precipitating water softener dissolved in water before adding clothes. Use non-chlorine bleach. 2. Have a special filter or chemical feeder installed in your home to remove iron and manganese from water. 3. Run hot water for a few minutes to clean iron residue buildup in lines; drain water heater occasionally. 4. To remove spots: spread stained portion over pan of boiling water and squeeze lemon juice through stain. To remove overall yellow, use a commercially available rust scale remover, following package instructions.

(continued next page)

The Problem Solver (continued)

PROBLEM	POSSIBLE CAUSE AND REMEDY
BLUE OR GRAY COLOR STAINS	<ul style="list-style-type: none"> • Improper use of fabric softener. Never pour fabric softener directly on clothes; always dilute before adding to rinse water. To remove stains: dampen stained area and rub with undiluted liquid detergent. Re-wash, using chlorine bleach if safe for fabric.
GRAYED CLOTHES	<ul style="list-style-type: none"> • Insufficient detergent. You may need to increase the amount of detergent used, if the load is larger than normal, if soil is heavier than average (especially oily soil), if water level is high, or if water hardness is above average. • Water is not hot enough for type of load. Make sure water heater is set to deliver hot water at the washer 140° - 150°F. (60° - 66°C.). Do not wash when other hot water needs—such as dishwashing or family baths—are heavy. • Poor or inferior detergent (or use of soap in hard water). Change to phosphate detergent if possible. <p>Follow these steps:</p> <ul style="list-style-type: none"> • Use water conditioner (such as Calgon brand). • Use hottest water possible. • Pretreat stains. • Use bleach where possible. • Use presoak aids. • Install water softener. <ul style="list-style-type: none"> • Washer overloaded. Clothes cannot move freely to loosen and remove soil, causing gray appearance. Follow correct loading procedures for size of load. • Improper soaking, with insufficient detergent. Usually a 30-minute soak is sufficient. However, when using extended soaks for heavily soiled garments, you may need to use twice the recommended amount of detergent. • Washing too long may result in increased soil redeposition. Use shorter wash time for smaller loads. • Detergent dissolves too slowly. It is important that detergent be present in the wash solution at the start of wash agitation. <p>To restore grayed clothes—</p> <p>Most grayed clothes can be at least partially restored by the following procedure:</p> <ol style="list-style-type: none"> Put clothes in washer. Fill with HOT water. Check manufacturers' hang tags to determine if hot water is suitable for garment. Add a non-precipitating type of water softener such as Calgon brand with phosphate. Use 2½ times as much as you need for normal water softening. Do not add soap or detergent. Allow clothes to go through complete cycle. Repeat, if necessary. If you prefer to soak clothes, use water softener in place of soak agent or pre-wash detergent and allow clothes to soak for about 20 minutes.

PROBLEM	POSSIBLE CAUSE AND REMEDY
HEAVILY SOILED AREAS such as collars and cuffs	<ul style="list-style-type: none"> • Pretreat with liquid detergent.
LINT OR RESIDUE ON CLOTHES	<ul style="list-style-type: none"> • Incorrect sorting of clothes. Separate lint-producers (such as terry towels and chenille) with lint-receivers (such as man-made fabrics, velveteen, corduroy). • Washing too long, especially for smaller loads. For normal soil, use 1 minute per pound of dry clothes. • Use of non-phosphate detergents which combine with hardness minerals in water to form a precipitate which can be mistaken for lint. • Use phosphate detergent or liquid detergent; use warmer wash water or soften water with an installed mechanical softener or a packaged water softener. • Undissolved granular detergent may leave powdery residue on fabrics which can be mistaken for lint. <ol style="list-style-type: none"> (a) See page 13 for recommendations on how to add detergent to speed up complete dissolving. (b) Use a liquid or special cold water detergent. (c) Predissolve granular detergent in hot water, or make sure detergent is dissolved completely in wash water before adding clothes. (d) Make certain clothes have ample room to move in washer. (e) Use a warmer wash water. • Overloading of washer will cause abrasion which creates excessive lint. Wash fewer items in each load. Make sure water level is correct for size of load. • Too much bleach. Over-bleached items, such as towels, will shed excessive lint. Use correct amount of bleach according to package directions. • Not enough detergent. Enough detergent must be used to hold lint in suspension during wash cycle. Increase amount of detergent used. Amount is determined by water hardness, size of load, degree of soil and amount of water. See page 13. • Incorrect use of fabric softener. If used in wash cycle, many softeners may react with detergent to create a white deposit. Use fabric softeners only in rinse cycle, unless package specifies adding to wash cycle. • Pilling, usually on polyester-cotton blends, is caused by normal wear and may look like lint. Turning clothes inside out may help. • Static electricity caused by overdrying will cause attraction. Use fabric softener in rinse cycle. <p>To correct— All of the above causes of residue except pilling can usually be removed from garments through use of correct laundry procedures.</p>

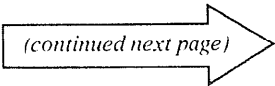
(continued next page) 

The Problem Solver (continued)

PROBLEM	POSSIBLE CAUSE AND REMEDY
<p>SNAGS, HOLES, TEARS, RIPS OR EXCESSIVE WEAR</p> <p><i>There is no solution once this type of damage has occurred.</i></p>	<ul style="list-style-type: none"> • Pins on garments or sharp objects left in pockets. Remove all pins, check pockets of all garments before putting in washer. Also check washer to see if any objects remained in wash tub. • Snaps, hooks, sharp buttons, belt buckles, zippers. Make sure all hooks, snaps and buttons are fastened. Remove sharp buttons and belt buckles. This is very important when washing knits, which snag easily. Turn knits inside out. • Improper use of chlorine bleach. Holes may have random square shape; yellow discoloration, fabric will be weak at edges of hole. <ul style="list-style-type: none"> (a) Use only correct, measured amount of bleach. (b) Never add undiluted bleach to washer tub nor allow clothes to come in contact with undiluted bleach. Do not wipe up bleach spills with clothes. (c) Damage from chemicals such as hair preparations (bleach, dye, home permanent solution), battery acid, some toilet bowl cleaners. Immediately rinse thoroughly towels and other articles which have come in contact with these chemicals before putting them in washer. Avoid contaminating items of clothing with such chemicals. • Small, unnoticed holes, tears or ripped seams may enlarge during washing. Check garments carefully before loading washer and mend all rips and tears. • As permanent press garments age, they may show fraying at collars and cuffs. This is due to the weakening of the fibers by the permanent press process. It is not caused by the washer. You can slow this process by washing small permanent press loads with a large water level. Do not wash heavy items such as towels with permanent press. When possible, remove collar stays. • Roughness or burrs on agitator due to damage incurred by heavy belt buckles, etc. Examine agitator for roughness or burrs and smooth by filing if necessary. • May be using wrong cycle for delicate fabrics. Use delicate cycle. Refer to garment manufacturer's care instructions. • Garments weakened by aging, or by sun or atmosphere. This is an inevitable process and is not caused by the washer. You may slow down process by use of delicate cycle. • Too little water in washer or too large a load. Load washer only with the number of items that will move freely. Select correct water level.

PROBLEM	POSSIBLE CAUSE AND REMEDY
<p>WRINKLING IN PERMANENT PRESS AND "NO-IRON" ITEMS</p>	<ul style="list-style-type: none"> • Leaving clothes in dryer after tumbling stops. Immediately after dryer stops tumbling, remove clothes and place them on hangers. • Too many items in dryer. Dry only one washer load at a time. Do not combine loads. • Too few items in dryer. If drying only one article, add two or more similar articles, even if dry, to insure proper tumbling. • Improper loads. Avoid laundering heavy permanent press items, such as work clothes, with lighter permanent press items such as shirts or blouses. Also do not wash or dry permanent press items with regular laundry. • Too many items in washer. Items must have room to move freely. Permanent press loads should always be smaller than regular loads...no more than medium loads. • Use of incorrect wash and dry cycles. Use permanent press wash cycle which provides a cool-down rinse to minimize wrinkling. Also, use automatic dry cycle. • Incorrect water level. Use large level for medium load; medium level for small load. • Repeated washing in too hot water. Wash in cold or warm water with plenty of detergent. • Accumulation of lime scale due to use of carbonate detergents. If a non-phosphate detergent must be used, avoid the use of a carbonate-built detergent. • Failure to use fabric softener. Proper use of fabric softener will minimize wrinkling. <p>To remove stubborn wrinkles—</p> <ol style="list-style-type: none"> 1. Retumble on automatic dry setting with small load. 2. Rinse and dry on automatic dry setting. 3. If unsuccessful, retumble on high heat for 10-12 minutes and hang immediately. 4. Iron carefully. 5. Send to cleaners for pressing. 6. Some wrinkles may remain which cannot be removed.* <p>*NOTE: If you follow good laundry procedures and permanent press clothes still come out wrinkled, the finish may not be good quality. Also, in permanent press synthetic/cotton blends, the cotton portion of the fabric can eventually wear away leaving only the synthetic. Since the cotton has resin finish that imparts the memory, a loss or decrease of permanent press performance will result.</p>

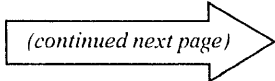
(continued next page) 

The Problem Solver (continued)

PROBLEM	POSSIBLE CAUSE AND REMEDY
SHRINKAGE, GENERAL	<ul style="list-style-type: none"> • Some fabrics will shrink whether washed in a washer or by hand; others may be safely washed but will shrink in a dryer. Follow garment manufacturers' care instructions exactly. If in doubt, do not machine wash or dry.
SHRINKAGE, KNITS	<ul style="list-style-type: none"> • Relaxation shrinkage can occur in knit fabrics that have been improperly stretched and elongated by the manufacturer. When this occurs, garment may be pressed back into shape after each wash and dry cycle. • Progressive or delayed shrinkage is caused when starch or sizing (in some fabrics) is gradually removed by laundering. May be noticed in older garments that have been washed many times without previous shrinkage. Treat as for Relaxation Shrinkage above. • Shrinkage caused by overheating occurs in certain knit fabrics that have been heat-shaped. When washing, drying or ironing temperatures exceed the temperatures used to shape set, shrinkage may occur. This cannot be corrected, but it can be prevented by washing in cool or warm water; drying on low or delicate heat.
CLOTHES TAKE TOO LONG TO DRY	<ul style="list-style-type: none"> • Controls improperly set. Check all controls to make sure they are correctly set for the load you want to dry. • Improper ducting. Make sure dryer is ducted in accordance with Installation Instructions. • Obstruction in exhaust ducting. Make sure ducting is clean and free of obstruction, make sure damper in outside wall cap operates easily. If metal flexible ducting is used, be sure it is not kinked and is installed according to Installation Instructions. • Blown fuses or tripped circuit breakers. Check household fuses or circuit breakers. Most electric dryers use two. It is possible for one to be blown or tripped, and the dryer to still tumble without heat. • Improper sorting. Do not mix heavy, hard-to-dry items with lightweight articles. • Too many items in dryer. Dry only one washer load at a time. Do not combine loads. • Too few items in dryer. If drying only one article, add two more similar articles, even if dry, to insure proper tumbling. • If your dryer is operating on a 208-volt circuit, longer drying times can be expected. • Clothes were excessively wet when they were put into the dryer.
DRYER MAKES "THUMPING" NOISE	<ul style="list-style-type: none"> • Temporary start-up sound. Dryer drum is mounted on four specially compounded rubber wheels. After extended storage and exposure to extreme temperatures, a thumping noise may occur when dryer is first started. This will soon disappear.

If you need more help...call, toll free:
The GE Answer Center®
800.626.2000
 consumer information service

Care and Cleaning

USER MAINTENANCE INSTRUCTIONS

- Wipe the cabinet with a damp cloth. Occasionally wash it with mild soap and water and then apply a light coat of appliance polish to help preserve the finish.
 - Keep the area around and underneath your appliance free from the accumulation of combustible materials such as lint, paper, rags, chemicals, etc.
 - Keep the floor around your appliance clean and dry to reduce the possibility of slipping.
 - For long vacations, be sure water supply is shut off at faucets. Drain all water from hoses if the appliance will be exposed to freezing weather.
 - Winterizing instructions: The washer cannot be operated in freezing temperatures. Before you store the appliance, remove water from all parts of the washer.
1. Turn off water supply faucets. (The front access panel between washer and dryer may have to be removed. See procedure at right.) Disconnect hoses from faucets and drain.
 2. Add 1 gallon of non-toxic RV antifreeze (available from the hardware or recreational vehicle store) to the washer tub.
 3. Push the timer knob in, turn the knob to the right to SPIN and pull the knob out.
 4. Let the washer spin for 1 or 2 minutes to let all water drain out. Some but not all of the RV antifreeze will be expelled.
 5. Push in the timer knob, dry the tub interior, disconnect the electrical plug, close the lid.
 6. Store the appliance in an upright position.
 7. Before reusing washer, after storage, run washer through a cycle to rinse out the antifreeze.

Washer

- **Lint filter.** The self-cleaning lint filter needs no attention from you.
- **Washbasket.** After each use, leave the lid open to allow moisture to evaporate. Clean thoroughly with nonabrasive household cleanser to remove deposit left by heavily soiled clothes. Do not use harsh cleansers.

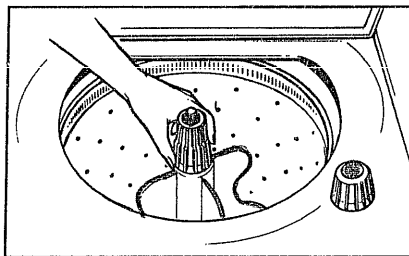

- **Agitator.** Remove the agitator at regular intervals—about 4 to 6 months—and remove any lint that may have accumulated. After removing the front access panel, as shown at right, unscrew the agitator cap, grasp the agitator with both hands, and pull it up and out of the washbasket.

The slotted section at the top of the metal shaft has a light coating of lubricant to prevent parts from sticking together. If this area appears to be dry, apply a light coat of grease or petroleum jelly around the shaft before replacing the agitator. Do not overgrease. Excess grease may get into the clothes load.

When replacing the agitator, carefully lower it straight down onto the agitator support block and replace the cap securely.

Dryer

If your dryer is exhausted to the outside, inspect and clean the dryer exhaust ducting at least once a year.

How to reduce the possibility of a fire hazard, if your dryer is not exhausted to the outside:

A clothes dryer produces combustible lint. When the dryer is not exhausted to the outside, this lint is more apt to accumulate in and near the dryer, which could create a fire hazard.

- Clean the lint filter before every load. See page 7.

- Inspect the area behind the front access panel at least once a year and clean out any lint that may have accumulated. Wipe or vacuum, being careful not to disturb any electrical or mechanical connections.

How to remove the front access panel between the washer and dryer

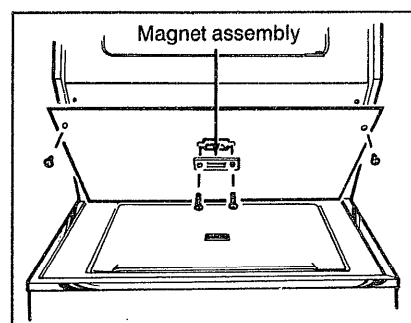

Take out 2 screws holding the magnet assembly and remove the magnet assembly.

Then take out 2 screws at top corners of access panel and lift access panel up until tabs at bottom of panel slip out of slots at rear of washer.

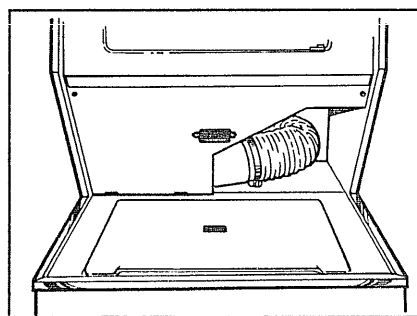

The washer lid can now be opened enough to allow you to remove the agitator, and the dryer exhaust ducting is accessible for inspection and cleaning.

To replace the front access panel, fit tabs on panel into slots at rear of washer, push panel back in place and replace screws and magnet assembly.

If You Need Service

To obtain service, see your warranty on the back page of this book.

We're proud of our service and want you to be pleased. If for some reason you are not happy with the service you receive, here are three steps to follow for further help.

FIRST, contact the people who serviced your appliance. Explain why you are not pleased. In most cases, this will solve the problem.

NEXT, if you are still not pleased, write all the details—including your phone number—to:

Manager, Consumer Relations
GE Appliances
Appliance Park
Louisville, Kentucky 40225

FINALLY, if your problem is still not resolved, write:

Major Appliance
Consumer Action Panel
20 North Wacker Drive
Chicago, Illinois 60606

YOUR GENERAL ELECTRIC SPACEMAKER™ LAUNDRY WARRANTY

Save proof of original purchase date such as your sales slip or cancelled check to establish warranty period.

WHAT IS COVERED

FULL ONE-YEAR WARRANTY

For one year from date of original purchase, we will provide, free of charge, parts and service labor in your home to repair or replace **any part of the Spacemaker™ laundry** that fails because of a manufacturing defect.

LIMITED ADDITIONAL FOUR-YEAR WARRANTY

For the second through fifth year from date of original purchase, we will provide, free of charge, replacement parts for **any part of the washer transmission** that fails because of a manufacturing defect. You pay for the service trip to your home and service labor charges. Or, if you desire, we will provide a **completely reconditioned transmission**. You pay for the shop reconditioning labor, the service trip to your home and service labor charges.

This warranty is extended to the original purchaser and any succeeding owner for products purchased for ordinary home use in the 48 mainland states, Hawaii and Washington, D.C. In Alaska the warranty is the same except that it is LIMITED because you must pay to ship the product to the service shop or for the service technician's travel costs to your home.

All warranty service will be provided by our Factory Service Centers or by our authorized Customer Care® servicers during normal working hours.

Look in the White or Yellow Pages of your telephone directory for GENERAL ELECTRIC COMPANY, GENERAL ELECTRIC FACTORY SERVICE, GENERAL ELECTRIC-HOTPOINT FACTORY SERVICE or GENERAL ELECTRIC CUSTOMER CARE® SERVICE.

WHAT IS NOT COVERED

- Service trips to your home to teach you how to use the product.

Read your Use and Care material.

If you then have any questions about operating the product, please contact your dealer or our Consumer Affairs office at the address below, or call, toll free:

The GE Answer Center®
800.626.2000
consumer information service

- Improper installation.

If you have an installation problem, contact your dealer or installer. You are responsible for providing adequate electrical, plumbing, exhausting and other connecting facilities.

- Replacement of house fuses or resetting of circuit breakers.

- Failure of the product if it is used for other than its intended purpose or used commercially.

- Damage to product caused by accident, fire, floods or acts of God.

WARRANTOR IS NOT RESPONSIBLE FOR CONSEQUENTIAL DAMAGES.

Some states do not allow the exclusion or limitation of incidental or consequential damages, so the above limitation or exclusion may not apply to you. This warranty gives you specific legal rights, and you may also have other rights which vary from state to state. To know what your legal rights are in your state, consult your local or state consumer affairs office or your state's Attorney General.

Warrantor: General Electric Company

If further help is needed concerning this warranty, write:

Manager—Consumer Affairs, General Electric Company, Appliance Park, Louisville, KY 40225