

This Owner's Manual is provided and hosted by [Appliance Factory Parts](#).

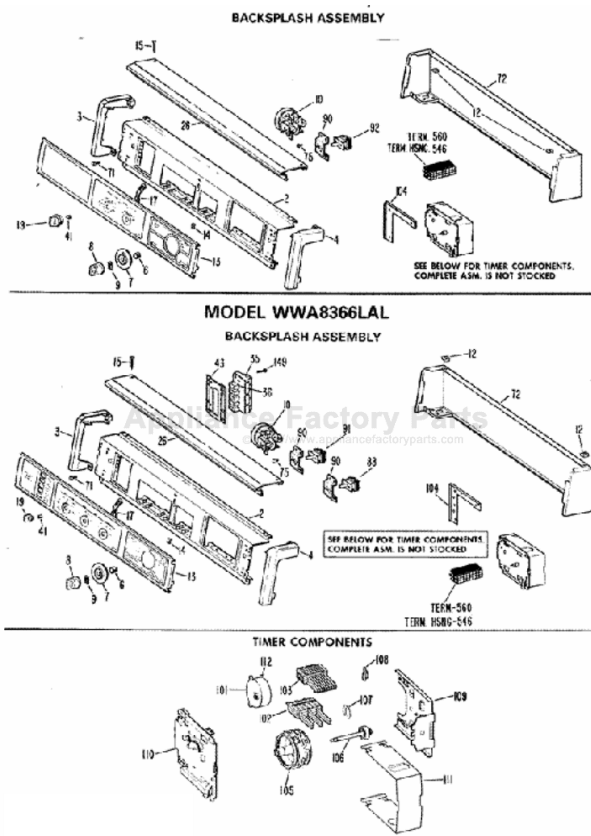

# GE WWA8366LAL Owner's Manual

[Shop genuine replacement parts for GE WWA8366LAL](#)



[Find Your GE Washer Parts - Select From 4591 Models](#)

----- Manual continues below -----

WWA8364V

PUB#  
49-9548

How to get the best from

# Your Washer

Setting the controls	p4	Use and Care of model WWA8364V
Bleach and Fabric Softener Dispensers	p8	
Using the Mini-Basket™ tub	p9	
Energy-saving tips	p10	
Sorting and loading	p11	
Choosing detergents	p13	
Stain removal	p18	
Questions? Use the Problem Solver	p20	



Your Direct Line to General Electric  
The GE Answer Center® 800.626.2000

EFFDATE

1-30-87

GENERAL  ELECTRIC

49-9548

# Contents

Safety instructions . . . . .	3, 4
How to operate your washer . . . . .	4, 5
Controls setting guide for different fabrics and loads . . . . .	6, 7
How to use the Bleach and Fabric Softener Dispensers . . . . .	8
How to use the Mini-Basket™ tub . . . . .	9
Energy-saving tips . . . . .	10
How to sort the clothes . . . . .	11
It pays to check and pre-treat . . . . .	11
Soaking . . . . .	11
How to load your washer . . . . .	12
What is the best size load of clothes? . . . . .	12
Factors to consider in selection of detergents and soap . . . . .	13
The results of continued use of carbonate detergents . . . . .	14
How much detergent or soap should you use? . . . . .	15
How to use detergent or soap . . . . .	15
Hard water—do you have it? . . . . .	16
Other laundry products . . . . .	17
How to remove stains . . . . .	18, 19
The Problem Solver . . . . .	20-25
User maintenance instructions . . . . .	26
If you need service . . . . .	27
Warranty . . . . .	Back Cover

## Help us help you...

### Before using your washer, read this book carefully.

It is intended to help you operate and maintain your new washer properly.

Keep it handy for answers to your questions.

If you don't understand something or need more help, write (include your phone number):

Consumer Affairs  
General Electric Company  
Appliance Park  
Louisville, KY 40225

### If you received a damaged washer...

Immediately contact the dealer (or builder) that sold you the washer.

### Save time and money.

Before you request service... check the Problem Solver on pages 20-25. It lists causes of minor operating problems that you can correct yourself.

### Write down the model and serial numbers.

You'll find them on a label on the lower left side near the front.

These numbers are also on the Consumer Product Ownership Registration Card that came with your washer. Before sending in this card, please write these numbers here:

Model Number \_\_\_\_\_

Serial Number \_\_\_\_\_

Use these numbers in any correspondence or service calls concerning your washer.

To obtain Hispanic version of this book, call  
The GE Answer Center®  
800.626.2000  
consumer information service.  
Toll-free.

Para obtener la versión en español de este manual, llame gratis a  
The GE Answer Center,®  
servicio de información para el consumidor,  
teléfono 800.626.2000.

All washing instruction terms in this book conform to the Care Labeling Rule established by the Federal Trade Commission, January 1984.

#### FOR YOUR SAFETY

If you smell gas:

1. Open windows.
2. Don't touch electrical switches.
3. Extinguish any open flame.
4. Immediately call your gas supplier.

#### FOR YOUR SAFETY

Do not store or use gasoline or other flammable vapors and liquids in the vicinity of this or any other appliance.

# IMPORTANT SAFETY INSTRUCTIONS

Read all instructions before using this appliance.

**WARNING**—To reduce the risk of fire, electric shock, or injury to persons when using your appliance, follow basic precautions, including the following:

- Use this appliance only for its intended purpose as described in this Use and Care Book.

- This washer must be properly installed and located in accordance with the Installation Instructions before it is used. If you did not receive an Installation Instructions sheet with your washer, you can obtain one by contacting the service location nearest you.

- Properly ground to conform with all governing codes and ordinances. Follow details in Installation Instructions.

- Install or store where it will not be exposed to temperatures below freezing or exposed to the weather.

- Connect to a properly rated, protected and sized power supply circuit to avoid electrical overload.

- Connect to adequate plumbing and drain facilities as described in the Installation Instructions.

- Turn off water faucets when the washer is not in use to relieve pressure on hoses and valves, and to minimize leakage if a hose or valve should break or rupture.

- When disconnecting this appliance pull by the plug rather than the cord to avoid damage to the cord or junction of cord and plug. Make sure that the cord is located so that it will not be stepped on, tripped over or otherwise subjected to damage or stress.

- Do not repair or replace any part of the appliance or attempt any servicing unless specifically recommended in this Use and Care Book or in published user-repair instructions that you understand and have the skills to carry out.

## To minimize the possibility of injury:

- Do not mix chlorine bleach with ammonia or acids such as vinegar and/or rust remover. Mixing can produce a toxic gas which may cause death.

- Do not wash or dry articles that have been cleaned in, washed in, soaked in, or spotted with combustible or explosive substances (such as gasoline, degreasers, dry-cleaning solvents, kerosene, etc.) which may give off vapors that could ignite or explode.

Do not add these substances to the wash water, and do not use these substances around your washer and/or dryer during operation.

- HYDROGEN GAS is produced by the chemical action within your water heater and the gas can accumulate in the water heater and/or water pipes if hot water has not been used for a period of two weeks or longer. **HYDROGEN GAS CAN BE EXPLOSIVE UNDER THESE CIRCUMSTANCES.** So to prevent the possibility of damage or injury, if you have not used hot water for two weeks or more, or move into a residence in which the hot water system may not have been used for some time, turn on *all* hot water faucets and allow them to run for several minutes before using any electrical appliance which is connected to the hot water system. This will allow any hydrogen gas to escape. Since the gas is flammable, do not smoke or use an open flame or appliance during this process.

- Never reach into washer while it is moving. Before loading, unloading or adding clothes, push in the Cycle Selector knob to "STOP" position, then wait until the machine has completely stopped before opening the lid.

- Close supervision is necessary if this appliance is used by or near children. Do not allow children to play inside, on or with this appliance or any discarded appliance. Dispose of discarded appliances and shipping or packing materials properly. Before discarding a washer, or removing from service, remove the washer lid.

- Keep all laundry aids (such as detergents, bleaches, fabric softeners, etc.) out of the reach of children, preferably in a locked cabinet. Observe all warnings on container labels to avoid personal injury.

- Keep the area around and underneath your appliances free from the accumulation of combustible materials, such as lint, paper, rags, chemicals, etc.

- Keep the floor around your appliances clean and dry to reduce the possibility of slipping.

- To minimize the possibility of electric shock, unplug this appliance from the power supply before attempting any maintenance or cleaning (except the removal and cleaning of the lint filter).

**NOTE:** Turning the Cycle Selector knob to an OFF position does NOT disconnect the appliance from the power supply.

- Do not tamper with controls.

- Do not operate this appliance if it is damaged, malfunctioning, partially disassembled, or has missing or broken parts, including a damaged cord or plug.

- Never climb on or stand on the washer top.

- Do not wash fiberglass articles in your washer. Skin irritation could result from the remaining particles that may be picked up by clothing during subsequent washer use.

(continued next page)

# Important Safety Instructions (continued)

• The laundry process can reduce the flame retardancy of fabrics. To avoid such a result, the garment manufacturer's care instructions should be followed very carefully.

## For washer operation

• Do not leave washer lid up during cycle. This will stop the

wash and spin action and prevent completion of the cycle.

• Do not change SPEED SELECTION while washer is operating. If a change in speed is desired, push in Cycle Selector Knob to "STOP" position and wait for washer to stop. Then select the

new speed and pull out Cycle Selector Knob to restart.

# SAVE THESE INSTRUCTIONS

## How to operate your clothes washer

**WARNING**—To reduce the risk of fire, electric shock, or injury to persons, read the IMPORTANT SAFETY INSTRUCTIONS before operating this appliance.

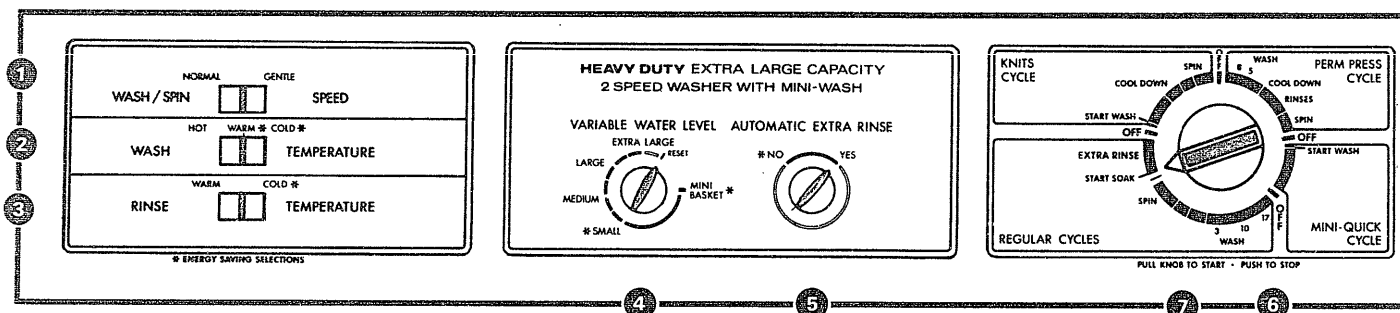

## Sorting and Loading

• Sort clothes carefully by fabric type, weight, color and amount of soil according to instructions on page 11.

• Remove Filter-Flo® pan and Mini-Basket™ tub. The underside of the lid is a good place to put the pan while loading or unloading clothes.

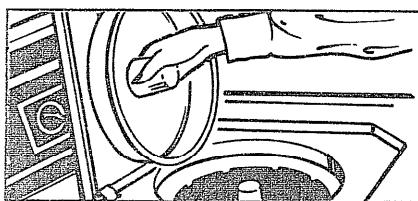

Do not use Mini-Basket tub when washing regular loads. You'll find complete details on how and when to use the Mini-Basket tub on page 9.

• Load clothes into the wash basket, being careful not to overload. Clothes should be below the retaining ring. See page 12 for more loading information.

• Position Filter-Flo pan on agitator and add measured amount of detergent. See pages 13 through 17 for information on detergents and other laundry additives.

**NOTE:** Do not use the Filter-Flo pan as a wash basket. Do not put any items to be washed in the Filter-Flo pan.

• See page 8 for information on how to use Bleach and Fabric Softener Dispensers. For information on bleaches and fabric softeners, see page 17.

• Close lid, washer will fill but not agitate or spin with lid open.

④ Select Water Level.

**SMALL:** Washer is less than 1/3 full of clothes.

**MEDIUM:** Between 1/3 and 1/2 full.

**LARGE:** Between 1/2 and 2/3 full.

**EXTRA LARGE:** Over 2/3 full.

**MINI-BASKET:** See page 9.

If you wish to increase level after you've made a selection, turn knob to "RESET" and select new level.

⑤ Select Extra Rinse, if desired. Turning control to "YES" will provide a second deep rinse in the Regular Cycle. If no Extra Rinse is desired, turn control to "NO."

## Setting the Controls

Use the Controls Setting Guide on pages 6 and 7 to help you make the proper selections.

① Select Wash/Spin Speed.

② Select Wash Temperature.

③ Select Rinse Temperature.

Cold rinse will be automatically provided when Cold Wash is selected.

# Tips to Help You Select Settings

6 Push Cycle Selector Knob in and turn clockwise to your selected wash setting.

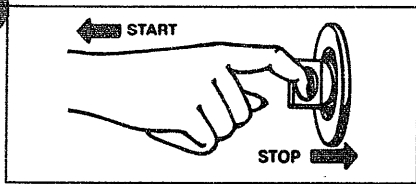

7 Pull Cycle Selector Knob out to start the washer. If you wish to change setting after washer has started, push Cycle Selector Knob in to stop the washer and reset to the new position. Setting can be changed at any time.

## REGULAR CYCLES—

Provide longer wash time for most cottons, linens, work and play clothes. "Extra Rinse" can be selected if desired.

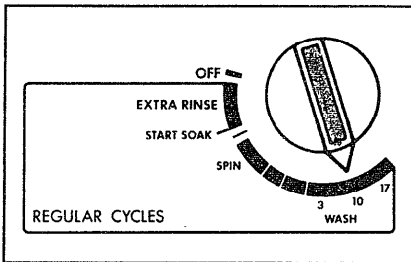

## PERM PRESS CYCLE—

An extended cool-down spray rinse is provided to minimize the setting of wrinkles.

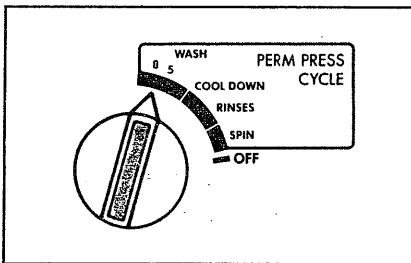

## KNITS CYCLE—

A combination of agitation and soak for more effective polyester knits laundering. Plus an extended cool-down spray rinse is provided to minimize the setting of wrinkles.

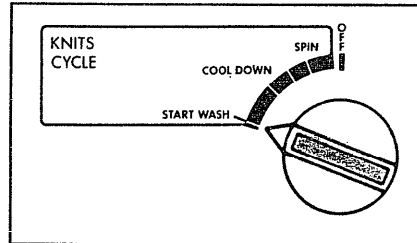

## MINI-QUICK CYCLE—

For small, lightly soiled loads you need in a hurry. Use with MINI-BASKET tub only.

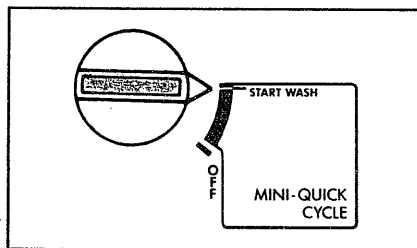

## What Happens in Each Setting (Approximate Minutes)

Cycle Selector Settings	Regular	Soak	Perm. Press	Knits	Mini-Quick
Wash				4	
Soak				3½	
Wash	3 to 17		5 to 8	2	3½
Spin	3½		2½	3	2
Rinse	3½	2	3½	3	2
Spin	7	7	4½	4½	2½
2nd Rinse	*2				
Spin	*7				
Total Time	22 to 36 *35 to 49	10	21 to 24	25	15

\* When "Extra Rinse" control is turned to "YES."

### NOTES:

- Total time includes pauses between each phase of cycle.
- Total time does *not* include water fill time. Fill times vary depending on household water pressure and your selected water level.

## SOAK SETTING—

Use with most soaking aids to loosen embedded soils and stains.

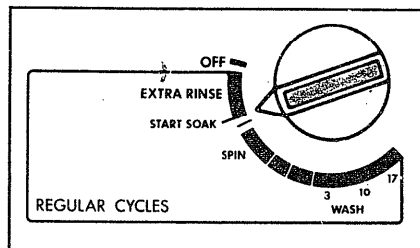

TURN THE PAGE  
for Controls Setting Guide

# Controls Setting Guide for different fabrics and loads

Load	Wash/Spin Speed	Wash Water Temperature*	Cycle	Cycle Setting
Cottons and Linens White/Colorfast Bright/Non-colorfast	Normal Normal	Hot or Warm Warm or Cold	Regular Cycle Regular Cycle	10 minutes 10 minutes
Work Clothes Heavy soil	Normal	Hot	Regular Cycle	10 minutes for small loads, 17 minutes for all other loads
Average soil	Normal	Hot or Warm	Regular Cycle	14 minutes
Permanent Press, Treated Cottons, Blends with Cottons Heavy or oily soil	Normal	Hot	Perm Press Cycle	8 minutes
Average or light soil	Normal	Warm	Perm Press Cycle	5 to 8 minutes
Synthetics—Polyester, Nylon, Acrylic Knits and Woven Fabrics Sturdy	Normal	Warm	Knits Cycle	Set at Start Wash.
Delicates	Gentle	Warm	Knits Cycle	Set at Start Wash.
Silks, Wools; Blends of Silk and Wool	Gentle	Warm	Knits Cycle	Set at Start Wash.
Rayon and Acetate	Gentle	Warm	Knits Cycle	Set at Start Wash.
Down-filled garments, if machine washing is recommended	Gentle	Warm	Perm Press Cycle	8 minutes
Baby Clothes—Sturdy, such as Diapers, Nightgowns, Shirts, Pads, Sheets, Receiving Blankets, Coveralls	Normal	Hot	Regular Cycle	10 to 14 minutes, depending on amount of soil
Baby Clothes—Delicate	Gentle	Warm	Knits Cycle	Set at Start Wash.
Blankets—Wool, Part-Wool, Cotton	5 min. soak then Normal	Warm	Regular Cycle	3 minutes
Blankets—Synthetic, Electric	5 min. soak then Normal	Warm	Regular Cycle	3 minutes
Curtains—DO NOT MACHINE WASH FIBERGLASS	Gentle	Hot or Warm	Perm Press Cycle	8 minutes
Chenille Bedspreads, Robes**	Gentle	Hot or Warm	Perm Press Cycle	5 to 8 minutes
Slipcovers, Draperies, Bath Mats and Rugs**	Normal	Hot or Warm	Regular Cycle	14 minutes
Denims (especially Indigo Blue Jeans) and other fabrics that bleed	Normal	Cold or Warm	Regular Cycle	14 minutes
Rubber-coated Items, Laminated Fabrics, Vinyl, Plastics and Articles with Plastic Trim	Gentle	Warm	Knits Cycle	Set at Start Wash.
Pillows	Gentle	Warm	Perm Press Cycle or Knits Cycle depending on amount of soil	5 to 8 minutes 5 to 8 minutes

\*Use Cold Rinse to save energy.

\*\*Check size. Some slipcovers, draperies and bedspreads may be too large for automatic home-size washer.

Bleach	Special Instructions
Liquid chlorine type. Non-chlorine type.	If colorfast is unusually soiled, use hot water. Use maximum detergent recommended on page 15.
White or colorfast, liquid chlorine type. Non-colorfast, non-chlorine type.	Use maximum detergent recommended in guide on page 15.
White or colorfast, liquid chlorine type. Non-colorfast, non-chlorine type.	Small loads reduce wrinkling. Use maximum detergent recommended in guide on page 15.
White or colorfast, liquid chlorine type. Non-colorfast, non-chlorine type.	If unusually soiled, use hot water. Use maximum detergent recommended in guide on page 15. Small loads reduce wrinkling.
No bleach	Wash <i>only</i> if recommended by the garment manufacturer. Follow instructions carefully.
Seldom needed. If needed, use only non-chlorine type.	Wash in your washer only if recommended by the garment manufacturer.
No bleach	Wash frequently to fluff up the down and retain the garment's warmth. Wash separately. Wet down gives off an odor which may be absorbed by other garments. Odor disappears when garment is dry. Treat heavily soiled areas with liquid detergent or paste made of water and granular detergent. Close zippers. Wash 2 or 3 at a time or add towels to balance. <b>GARMENT MUST BE TUMBLE DRIED.</b>
White or colorfast, liquid chlorine type.	You may prefer to use a mild type detergent. Do baby clothes separately. Pretreat spots. Rinse diapers, nightgowns, pads and sheets after use. Keep diapers in a covered pail of cold water and conditioning agent like Borateem brand.
Non-chlorine type.	You may prefer to use a mild type detergent. Do hand-knit garments by hand or in Mini-Basket tub. See page 9.
No bleach	Fill washer, add detergent, allow to dissolve before adding blanket. Do one blanket at a time. Pretreat heavily soiled spots with liquid detergent.
No bleach	On electric blanket, sew a strong piece of cloth over plug to protect blanket and washer from damage. Do one blanket at a time. Pretreat heavily soiled spots with liquid detergent.
White or colorfast, liquid chlorine type.	Vacuum out loose dirt before washing.
White or colorfast, liquid chlorine type.	If unusually soiled, use Normal Wash/Spin Speed.
White or colorfast, liquid chlorine type.	Wash only 2 or 3 rugs or mats at one time. Shake before washing to remove excess dirt.
No bleach	For new "indigo blue" jeans, wash at least 3 times in very small loads with full water fill. Jeans need ample room to move to avoid white lines at creases. May discolor plastic washer parts. Subsequent washings will reduce discolorations, but will probably never eliminate it. The stained parts will not discolor subsequent washing loads.
No bleach	Tumble on FLUFF (No Heat).
No bleach	Pillows are made of different materials—dacron, fiber, foam, polyester, natural feathers and down. Many pillows can be machine washed, but <i>manufacturers' care labels must be followed carefully</i> . If washing is recommended, check pillows for weak seams or holes and mend to prevent escape of feathers or filling. Fill washer, add detergent and agitate for several minutes to dissolve detergent. Add two pillows at a time to balance load, use high water level.

**Refer to Garment Manufacturers' Care Labels.**

For more information on care labeling, send for "What's New About CARE LABELS?"

For sale by the Superintendent of Documents, U.S. Government Printing Office, Washington, D.C. 20402.

## How to use the Bleach Dispenser

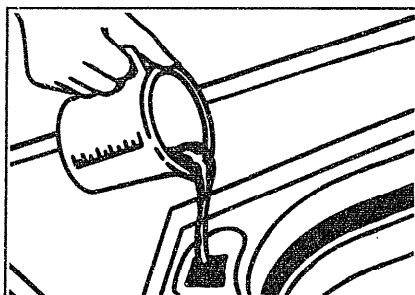

- Use this dispenser with liquid bleach only. If you prefer to use powdered bleach, pour it into the Filter-Flo pan or wash basket along with your detergent. Do not put powdered bleach into the bleach dispenser.

- Measure bleach carefully. Here are some recommended amounts:

LARGE WATER LEVEL—1¼ cup (310 ml) liquid

SMALL WATER LEVEL—2/3 cup (170 ml) liquid

MINI-BASKET tub—1/4 cup (60 ml) liquid

- Pour measured amount of liquid bleach directly into bleach dispenser.

- **Do not overfill or allow dispenser to overflow.** Avoid splashing. Undiluted bleach can cause fabric damage.

- **Never pour undiluted liquid bleach directly onto clothes or into the wash basket or Mini-Basket tub.**

## How to use the Fabric Softener Dispenser

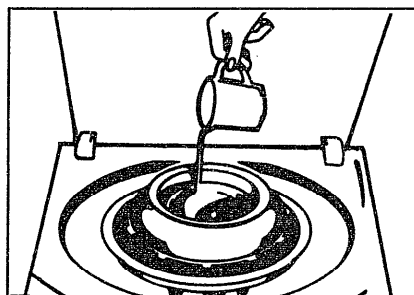

- Position the Fabric Softener Dispenser on the Filter-Flo pan.

- Pour manufacturer's recommended amount of fabric softener into a standard measuring cup.

- Add enough water to fill the cup 1/2 full.

- Pour the diluted softener into the dispenser.

- The fabric softener will automatically be dispensed at the proper time.

- **Do not stop the washer during the first spin.** This will cause the dispenser to empty too soon.

When using Fabric Softener Dispenser with the Mini-Basket tub, use one (1) teaspoon (5 ml) of concentrated softener or one (1) tablespoon (15 ml) of diluted softener.

- **Do not use the Fabric Softener Dispenser with the Soak Setting or the Mini-Quick Cycle.**

## How to Use the Soak setting

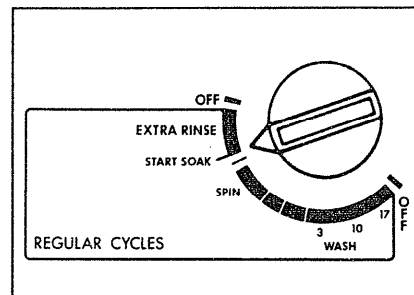

- "SOAK" setting temperature is controlled by the Rinse temperature switch. (If a warm soak is desired, set the WASH/RINSE TEMPERATURE switch to "HOT/WARM.")

- If a hot soak is desired, set the WASH/RINSE TEMPERATURE switch to "HOT/WARM" and turn the Cycle Selector Knob to "NORMAL" in the Regular Cycle. Start the washer. After washer fills and begins to agitate, push in the Cycle Selector Knob and turn to "SOAK." Pull out the Cycle Selector Knob to complete the cycle.

- **For an extended soak** allow the washer to fill and agitate for a few minutes to dissolve the soaking agent. Then push in the Cycle Selector Knob to stop the washer (keep lid closed) and allow to soak for as long as desired. After desired soak period, pull out the Cycle Selector Knob to complete the cycle.

- **Do not use the Fabric Softener Dispenser or the Mini-Basket tub with the Soak Setting.**

# How to use the Mini-Basket™ tub

The Mini-Basket™ tub, designed for small loads of regular fabrics or delicate hand-washables, can be used with any cycle except the SOAK setting.

## Typical Mini-Basket™ tub wash loads

- Small loads of regular fabrics (up to 2½ pounds).
- Delicate loads such as lingerie, panty hose, girdles, blouses, sweaters, socks, shirts, baby clothes and other small delicate hand washables.
- Stuffed toys.
- Tennis shoes.

## How to wash a small load of regular fabrics or delicate hand washables

1. Remove Filter-Flo pan.

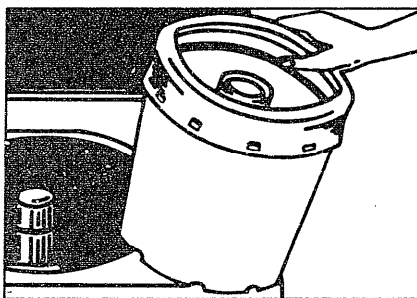

2. Place Mini-Basket tub on agitator. Pull the agitator toward the front of the machine for easier installation and removal of Mini-Basket tub.

3. Load clothes in Mini-Basket tub. See page 11 for sorting help.

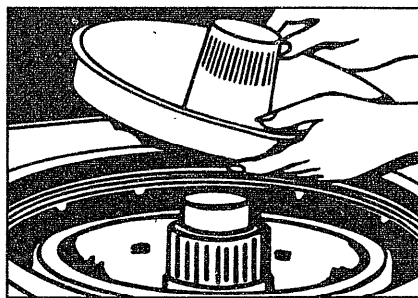

4. After loading clothes in the Mini-Basket tub, be sure to replace the Filter-Flo pan. The pan serves as a lid to keep the clothes in the Mini-Basket tub.

5. Put ¼ to ⅓ cup (60 to 80 ml) detergent into Filter-Flo pan.

6. Add bleach, if desired. Measure carefully and pour recommended amount of liquid bleach—¼ cup (60 ml)—directly into the bleach dispenser. See page 8 for dispenser instructions.

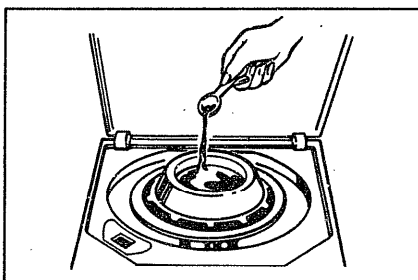

7. Add fabric softener, if desired (but not in the MINI-QUICK cycle described at right). Pour 1 teaspoon (5 ml) of concentrated softener or 1 tablespoon (15 ml) of diluted softener into Fabric Softener Dispenser on Filter-Flo pan. See page 8 for dispenser instructions.

## Special instructions for use of the Mini-Basket™ tub

- The Mini-Basket tub can be used with any cycle except the SOAK setting. When using the MINI-QUICK cycle, the Mini-Basket tub should be used.
- Do not wash clothes in the regular wash basket when using the Mini-Basket tub. There will not be enough water in the regular basket and clothes damage could result.

- Do not use the Fabric Softener Dispenser with the MINI-QUICK cycle. The cycle is too short for proper dispensing of the softener.
- When washing stockings, panty hose and other easily tangled items, always handle separately. To minimize tangling, the use of a net laundry bag is recommended.

8. Close lid and set controls as follows:

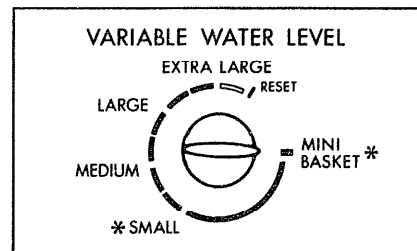

—Set Water Level to “MINI-BASKET” position.

—Select desired Wash/Spin Speed and Wash/Rinse Temperature. See page 4.

—Select desired cycle (REGULAR, PERM PRESS or KNITS). See page 4.

9. Pull Cycle Selector knob to start washer.

## How to use the MINI-QUICK cycle

The MINI-QUICK cycle is a short cycle intended to wash small loads of lightly soiled clothes you need in a hurry.

Because this cycle is a short one for small loads, the Mini-Basket tub should be used for satisfactory results.

1. Follow all the steps above and at left except for cycle selection.

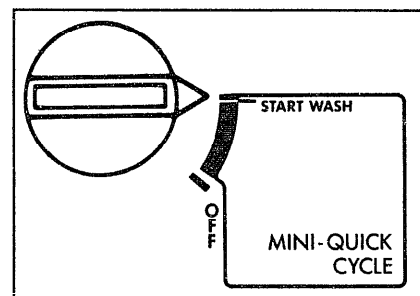

2. Push the Cycle Selector knob in and turn it clockwise to the MINI-QUICK cycle.

3. Pull the Cycle Selector knob to start the washer.

## Energy-Saving Tips

If your clothes and household items don't look clean and fresh after washing, you will probably re-wash them... and that means you'll waste energy. Remember to sort your clothes carefully, and load them properly, select correct cycles, use enough detergent and *choose a water temperature warm enough to release and get rid of soil.*

- Use Hot Wash—up to 150°F.—*on a regular basis only* when washing heavily soiled articles—such as work and play clothes.
- Under normal soil conditions, wash in water above 80°F. (27°C.). This generally means using the Warm Wash temperature setting on your washer—temperatures approximately 90° to 110°F. or hand comfortable. If you notice that soil has accumulated after several consecutive washings, use Hot Wash occasionally, if safe for fabrics.
- Always rinse in Cold Water. The temperature of the rinse does not affect cleaning.
- Try to wash less often. Save articles of the same type of fabric until you have a full load.
- If you must wash smaller loads, adjust the amount of water. Small loads should have lower water levels.
- Wash in off-peak utility hours. Your local utility can tell you which are the off-peak hours.
- Use Normal Spin Speed to remove more water and help lessen drying time. The dryer will remove any wrinkles caused by the Normal Spin.
- Use your Mini-Basket™ tub for very small loads. It uses less water than the small water level in the big tub on this washer. You will also save on detergent and energy.

# How to sort the clothes

## Sort by surface texture

Separate

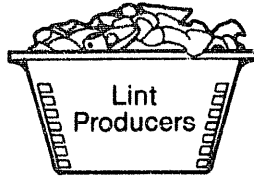

from

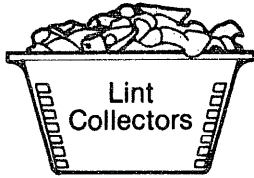

**LINT PRODUCERS**—such as terry toweling and chenille—give up lint.

**LINT COLLECTORS**—such as man-made fibers and napped fabrics like velveteen and corduroy—attract lint. These must be washed separately.

**FOR MORE INFORMATION ON LINT CONTROL, SEE PAGE 20.**

## Sort by fabric

Separate

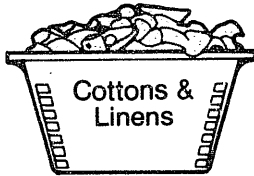

from



from

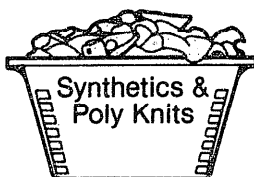

from

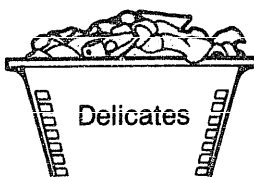

In addition to sorting to reduce lint collection, it is recommended that fabrics of similar construction be washed together whenever possible.

## Sort by soil

Separate

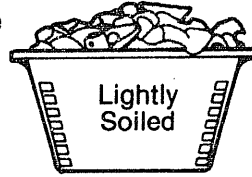

from

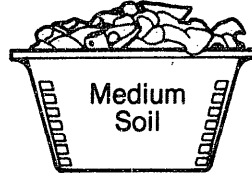

from

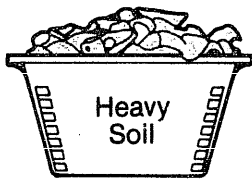

## Sort by color

Separate

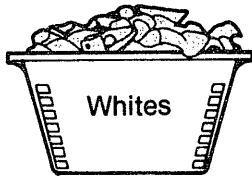

from

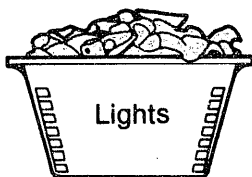

from

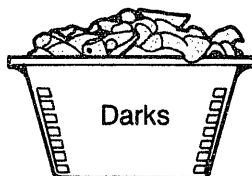

from

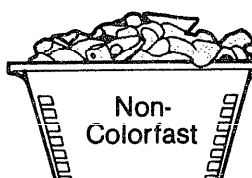

**FOR INSTRUCTIONS ON DIFFERENT FABRICS AND LOADS, SEE PAGES 6 and 7.**

## It pays to check and prepare clothes for washing.

- Empty pockets, brush out cuffs, zip zippers, snap snaps, hook hooks and button buttons.
- Do any necessary mending—rips, hems, tears.
- Check all items for areas of heavy soil or stain.
- Remove stains. **FOR STAIN REMOVAL CHART, SEE PAGE 18.**
- Turn Poly Knits inside-out to minimize fabric surface damage.

## Soaking & Pre-treating—a good way to loosen deep soils and stains.

A thorough soaking with detergent or special soaking agent is an excellent way to remove heavy soils, embedded dirt and even some stains.

Soaking can be either a completely separate washing step or a preliminary step to a complete wash cycle. For detailed information on how to soak in your washer, please see page 8.

## FOR INFORMATION ON SOAKING AGENTS, SEE PAGE 17.

- Pre-treat heavy soil by rubbing in a small amount of liquid detergent or a paste made of water and powdered detergent or soap. For best results wait ½ hour before washing.

# How to load your washer

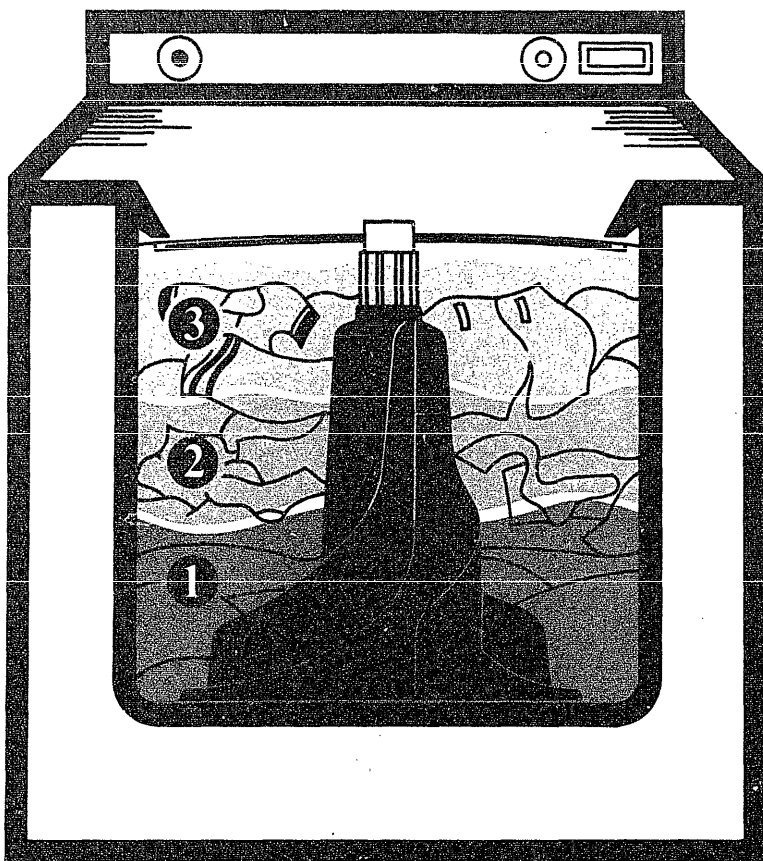

- Load clothes dry.
- Take a properly sorted group of clothes and drop them loosely in the wash basket in this order:

①

Large Items—like sheets. Do not wrap around the agitator.

②

Small Items—like washcloths.

③

Medium Size Items—like towels.

Here is a typical full load:

- 3 Double Sheets
- 6 Long Sleeve Shirts
- 3 Boxer Shorts
- 6 Standard Pillow Cases
- 5 T-shirts
- 4 Pair Trousers
- 6 Handkerchiefs

This illustration, with clothes just reaching the Clothes Retaining Ring, shows a proper load. Clothes have ample room to move because they are not packed down, nor wrapped around the agitator. Clothes are loaded dry since wet items are apt to pack down which encourages overloading. This size load requires a full water fill.

**What is the best size load of clothes—large, medium, or small? Save time, energy and detergent** by avoiding extra use of the washer. Try to wash a full load of clothes. If you can it is better to save clothes until you have a full load. If you must wash smaller loads, save water, energy and detergent by adjusting the water level for the size of the load. See page 4.

## Special recommendations for washing permanent press if you do not have a dryer.

If you are machine-washing Permanent Press clothes that you plan to line dry or drip-dry, use extra care to minimize wrinkling in the wash process:

- Be careful not to overload washer. Permanent Press clothes must have ample room to move freely. A Medium size Permanent Press load is the largest that should be washed.
- Use more water than you would for a regular load. Use a Medium Water Level for a Small Load; an Extra Large Water Level for a Medium Load.
- Remove clothes promptly as soon as washer stops and hang immediately.
- To minimize wrinkling, use Gentle Wash/Spin Speed.

## To add items after the washer has started.

- Turn off the washer.
- Carefully remove the Filter-Flo pan.
- Add any additional articles by submerging next to the agitator.
- Replace the Filter-Flo pan and restart the washer.

**NOTE:** Do not use the Filter-Flo pan as a wash basket. Do not put any items to be washed in the Filter-Flo pan.

**NOTE:** When washing stockings, panty hose and other easily tangled items, always handle separately. To minimize tangling, we recommend the use of a net laundry bag.

# Factors to consider in selecting detergents and soap

Products	Advantages	Disadvantages
<b>Phosphate— Powdered Detergents</b>	<p>Perform well in hard or soft water</p> <p>Wash all types of fabrics well. Can be used in hot, warm, or cold water.</p>	<p>Are not available in some areas.</p>
<b>Non-Phosphate— Powdered Detergents</b>	<p>Perform satisfactorily in soft or moderately hard water.</p> <p>In some areas only non-phosphate products are available.</p>	<p>Generally do not clean well in hard water.</p> <p>May be difficult to dissolve, especially in cold water.</p> <p>Should <i>not</i> be used in cold water.</p> <p>Those containing sodium carbonate as an ingredient may cause harmful limestone deposits on clothes and washer when combined with hard water. (See page 14.)</p>
<b>Liquid Detergents</b>	<p>Perform well in soft water.</p> <p>Offer better performance in hard water than powdered non-phosphate types.</p> <p>Cleans synthetics and fabric blends well.</p> <p>Are excellent as concentrates for removing spots.</p> <p>Completely dissolve even in cold water.</p>	<p>May not perform as well as powdered phosphate products when diluted in wash water.</p>
<b>Soaps</b>	<p>Perform well in soft water.</p>	<p>Generally do not clean well in medium-hard or hard water.</p> <p>May combine with water hardness minerals to form sticky soap curd.</p>

# The results of continued use of carbonate detergents

Is your water hard? If it is, and if you use a carbonate type non-phosphate detergent, you will most probably notice limestone\* deposits on your clothes and

washer surfaces. The hardness of your water and your washing frequency will determine how rapidly the limestone will build up. If your water is VERY HARD

(11 or more grains) and if you wash just a few loads a week, you may see limestone buildups in just a few months.

## Effects on clothes

Although limestone buildup occurs more rapidly on cotton, it will eventually affect various fabrics in the following ways:

- Gives a stiff, harsh, rough feel to fabrics such as toweling.
- Causes colors to fade and become dull and dingy.
- Causes graying of fabrics.
- Leaves a white, powdery residue on dark-colored items.
- Causes spot-fading of bright colors as a result of direct contact with detergent.
- Reduces wrinkle-resistance of permanent press fabrics.
- Destroys effectiveness of flame-retardant finishes on cottons such as children's sleepwear.
- Increases fabric wear because of the scrubbing action between limestone deposits on the fabrics during washer agitation.

## Effects on washer

- Unsightly buildup on all washer surfaces exposed to the wash solution.
- Mat-like, crusty formations caused by lint adhering to the sticky limestone deposits.
- Increased service calls because of limestone deposits in the pump, recirculation water hoses, filters and other washer parts.
- Reduced useful life of washer.

## Recommended methods to reduce limestone buildups

- Use a powdered phosphate detergent or a liquid detergent if these are available in your area.
- Install a home water softener. This will significantly reduce limestone buildup.
- Use a packaged non-precipitating water softener, such as Calgon brand with phosphate.

## Good washing practices may delay limestone damage to clothes

The following recommendations will temporarily delay the effects of limestone on your clothes. These are generally good washing practices and will give better soil removal whether or not you have hard water or use carbonate detergent.

- Use hotter wash water, for example up to 150°F. for cottons. This also improves oily-soil removal.
- If you wash in cooler water to save energy, use more detergent to promote better washing. Also be sure to use bleach on bleachable fabrics. Use hot water whenever possible.
- Add detergent and allow washer to fill and agitate for three or four minutes to dissolve detergent before adding clothes.
- Increase amount of detergent. See guide on page 15 for recommended detergent amounts in relation to water hardness.

- Increase use of bleaches, presoaks, packaged water conditioners, prewash soil and stain removers to help in removing stubborn soils and stains.
- Use greater care in sorting loads. Wash very dirty loads separately and increase detergent to help keep dirt from redepositing on less soiled items. Wash delicate items separately to prevent damage from heavy, sturdy clothes.
- Wash smaller loads to increase cleaning action of washer.
- Use fabric softener to counteract stiffness or harshness in clothes.

## How to partially restore clothes

Once clothes have developed deposits, they may be partially restored by soaking in a solution of two cups of vinegar in one gallon of hot tap water for 15 minutes. **USE A PLASTIC CONTAINER.** Then wash clothes in the washer using detergent.

### CAUTIONS:

- Do not use vinegar soak solution in washer. The acidic action of the vinegar may damage the porcelain.
- Vinegar soak solution may reduce the wrinkle-resistance of permanent press fabrics.
- Vinegar soak may damage the dyes in some fabrics.

\*LIMESTONE—technically called CALCIUM CARBONATE—is caused by the reaction of the calcium in the hard water with the sodium carbonate in the detergent.

# How much detergent should you use?

The use of a sufficient amount of detergent is one of the most important things you can do to make sure your wash comes out clean.

Amount required varies according to:

1. Water hardness
2. Amount of soil
3. Size of load
4. Type of detergent
5. Wash temperature

Use more detergent if you have . . .

1. Hard water
2. Large loads
3. Greasy or oily soils
4. Lower wash temperature
5. Low phosphate detergent.

If the recommended amount of detergent produces too many suds, switch to a low sudsing detergent brand, and follow instructions on package.

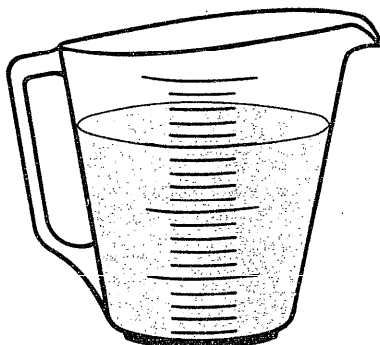

Using too little detergent is a common cause of laundry problems. Always measure detergent in a standard measuring cup.

## How to use detergent—granular or powdered:

Place detergent in the filter pan for normal conditions, but, for best results, put it next to the agitator after the clothes have been loaded.

If your detergent doesn't dissolve well, predissolve the detergent in hot water, then pour directly into the wash basket.

## Recommended amount of detergent for average soil load

	Water Hardness	Water Level Setting				
		Extra Large	Large	Medium	Small	Mini Basket
High Sudsing Powder Type	VERY HARD 10-20 Gr.	2 cups	1¾ cups	1½ cups	1¼ cups	½ cup
	HARD 4-10 Gr.	1¾ cups	1½ cups	1¼ cups	¾ cup	¼ cup
	SOFT 0-4 Gr.	1 cup	1 cup	¾ cup	½ cup	¼ cup
Low Sudsing Concentrated Powder Type	0-10 Grains	1 cup	¾ cup	½ cup	½ cup	¼ cup
LIQUID	0-10 Grains	FOLLOW PACKAGE DIRECTIONS				

1. Use recommended amount of detergent for your load and water hardness as shown in guide.

2. Other detergent types—Low and normal suds, powders, liquids, non-phosphate powders, follow recommendations on package.

3. For hard water treatment, see page 16.

## Hard water—do you have it?

Before you can decide what to do about hard water, you need to know if you have it and, if so, how hard it is.

- If you live in a municipal area, contact your water company.
- If you live in a rural area, or in some suburban areas, contact your county agent.

The answer will be “you have ‘so many grains’ per gallon” and means this:

0 to 3 grains per gallon—SOFT,  
4 to 10 grains—HARD, 11 to 19  
grains—VERY HARD, 20 grains  
and over—EXTREMELY HARD.

If your water is SOFT, you have no problem. You can use soap or detergent as you prefer and forget all about hard water. If you have HARD water—less than 10 grains—and you use phosphate detergent, you also have no problem.

But, if you have more than 10 grains, you will need to soften your water with either...

1. An installed water softener in your home, or
2. The use of a packaged water softener.

**For information on water softeners, see chart below.**

### Add this much water softener with a full water level

Grains of hardness	0-10	10-15	15-20	20-25	25-30	over 30
When using with detergent	0	¼ cup (60 ml)	½ cup (120 ml)	⅔ cup (160 ml)	1 cup (240 ml)	1 cup plus 1 tbs. for every 5 grains above 30 (240 ml plus 15 ml for each extra 5 grains)
When using with soap	⅓ cup (80 ml)	⅔ cup (160 ml)	¾ cup (180 ml)	1 cup (240 ml)	1½ cup (360 ml)	1¼ cup plus 1 tbs. for every 5 grains above 30 (300 ml plus 15 ml for each extra 5 grains)

# Other laundry products

Laundry product and type	How to use it	Special instructions
<p><b>BLEACH</b> Chlorine Liquid such as Clorox brand</p> <p>Non-chlorine such as Clorox 2 brand</p>	<p>Use your Bleach Dispenser according to instructions on page 8.</p> <p>Follow package directions. Put bleach into washer with detergent.</p>	<p>1) Do not pour undiluted liquid chlorine bleach directly into washer or on dry clothes. 2) Some of today's washable fabrics should not be chlorine bleached such as: 100% cotton flame-retardant children's sleepwear, silk, wool, mohair, spandex, leather, or non-fast colors. Dilute bleach before using on any fabric. 3) Check Manufacturers' Care Labels for special instructions.</p> <p>1) May be used on all kinds of fabrics. 2) Is most effective in hot water.</p>
<p><b>FABRIC SOFTENERS</b> Rinse additive such as Downy Brand</p> <p>Wash Additive such as Rain Barrel brand</p>	<p>Use your Fabric Softener Dispenser according to instructions on page 8.</p> <p>Follow package directions. Add during wash cycle.</p>	<p>1) Helps make clothes fluffy and soft. 2) Reduces static electricity. 3) Use carefully. Too much may cause staining on some clothes. 4) Do not pour directly on clothes. 5) For those recommended for adding to the wash cycle, such as Rain Barrel brand, follow manufacturer's instructions exactly.</p>
<p><b>SANITIZER</b> Chlorine Bleach, such as Clorox brand</p>	<p>Use in case of infection and contagious disease. See under Bleach above.</p>	<p>Guards against infection by killing most bacteria and viruses*</p>
<p><b>WATER SOFTENER</b> Non-precipitating such as Calgon brand</p> <p>Precipitating such as Borax brand</p>	<p>Follow package directions. Add at start of wash cycle.</p> <p>Follow package directions. Use with detergent or soap in wash cycle.</p>	<p>Suspends hardness minerals in solution, keeping water clear.</p> <p>Combines with water hardness minerals to form precipitate which gives cloudy or milky appearance to water.</p>
<p><b>SOAK AGENT</b> Such as Biz brand</p>	<p>Follow package directions.</p>	
<p><b>PRETREATING, STAIN AND SPOT REMOVERS</b> Such as Spray 'n Wash and K2R brands</p>	<p>Follow package directions. Treat only heavily soiled areas. Check garments' care labels for instructions.</p>	<p><b>CAUTION:</b> Washer control panels and finishes may be damaged by some laundry pretreatment soil and stain remover products if such products are sprayed on or have direct contact with the washer. Apply these pretreatment products away from washer. The fabric may then be washed normally. Damage to your washer caused by pretreatment products is not covered by your warranty.</p>
<p><b>TINTS AND DYES</b> Powdered such as Rit and Tintex brands</p>	<p>Follow package directions. NOTE: Tinted garments may not be colorfast. Wash separately.</p>	<p>Clean washer to avoid discoloration of next load. Go through complete cycle (5-minute wash) using hot water, 1/2 cup (120 ml) detergent, 1 cup (240 ml) bleach. Wipe exterior parts. Caution: Tinting may discolor plastic in washer. Subsequent washings will reduce discoloration but may never eliminate it.</p>

\*For more information on sanitizers, send for Government Bulletin, #57B, "Sanitation in Home Laundering," available from the Consumer Information Center, Pueblo, Colorado 81009.

# How to remove stains

1. Try to remove stains as soon as possible. The fresher the stain, the easier it is to remove.

2. Before attempting to remove any stain, **take these steps:**

- Find the fabric and the finish in the chart on the next page, and use only recommended methods.
- Check the care label instructions that came with the garment.
- Test stain removal product on a hidden inside seam or on a sample of the material.
- Avoid use of hot water on unknown stain. It can set some stains.

3. Follow stain removal with a thorough rinsing.

4. Wash with recommended amount of soap or detergent.

## **Stain Removal Hint— Using Chlorine Bleach for White and Bleachable Fabrics.**

Mix 1/4 cup (60 ml) chlorine bleach with one gallon (3.8 liter) of cool water—approximately 80°F. (27°C.)—in a sink or pan. Soak stained area for 5 minutes and launder in washer.

## **The Case of the “Invisible” Stain.**

Food or cooking oils on your synthetic garments may cause stains which are virtually invisible and which you may not notice as you put your clothes into the washer.

If these stains are not completely removed in the wash, the oily spots may pick up dirt from the wash water. Then they will become very visible and you may think they were caused by the wash cycle itself.

## **Once these spots become visible, how can you remove them?**

- Rub in undiluted liquid detergent and let stand 30 minutes.
- Re-wash using hottest water the fabric can stand.

## **How can you prevent these “After-You-Wash” stains?**

- Increase the amount of detergent normally used.
- Increase water temperature where fabric will permit.
- Wash synthetic garments more often.

## **See next page for Stain Removal Guide.**

For more complete information on stain removal, request government bulletin, “Removing Stains From Fabrics,” 054D. To obtain a copy write to: Consumer Information Center, Pueblo, Colorado 81009. Available at low cost.

# Stain removal guide

Stain	White and Bleachable Fabrics See Control Setting Guide, Bleach on Page 7	Other Washable Fabrics
Adhesives (Chewing Gum, etc.)	Rub with ice or immerse in very cold water. <i>Use dull tool to carefully scrape off as much adhesive or gum as possible.</i> Sponge with a safe dry cleaning fluid,* then launder.	Same as white and bleachable fabrics.
Anti-perspirants, Deodorants	Apply undiluted liquid detergent. Rinse. If stain remains, bleach according to Stain Removal Hint on opposite page. If color has changed, you may be able to restore it by sponging with ammonia.** Rinse thoroughly.	Same as white and bleachable fabrics except use non-chlorine bleach.
Blood	Soak in cold water, then launder in warm water. If stain remains, bleach according to Stain Removal Hint on opposite page, launder.	Sponge or soak in cool water, then launder.
Chocolate, Cream, Ice Cream and Milk	Soak in cold water. Treat stain with a safe dry cleaning fluid*; Apply undiluted liquid detergent, launder, dry. Bleach according to Stain Removal Hint on opposite page, launder and dry.	Soak in cold water. Sponge with a safe dry cleaning fluid.* Apply undiluted liquid detergent. Launder in warm water.
Coffee and Tea	Without cream: Bleach according to Stain Removal Hint on opposite page. Launder. With cream; Follow guide directions for cream.	Sponge with warm water. If stain remains, apply warm glycerine, let stand 30 minutes and rinse well, or sponge with a safe dry cleaning fluid.* Launder.
Cosmetics: Eye Shadow, Lipstick, Mascara, Liquid or Pancake Makeup, Rouge, Powder; Crayon; Grease, Oil, Tar, Cod Liver Oil.	Treat stain with safe dry cleaning fluid.* Apply undiluted liquid detergent; launder and dry. Bleach according to Stain Removal Hint on opposite page.	Sponge with a safe dry cleaning fluid.* Then launder in warm detergent water.
Fresh Fruit, Fruit Juices, Wine, Vegetables, or Food Coloring	Soak stain in cool water. If stain remains, bleach according to Stain Removal Hint on opposite page, launder.	Sponge with warm water. Bleach remaining stain with non-chlorine bleach.
Grass, Foliage, Flowers, Mildew, Scorch	Apply undiluted liquid detergent. Launder. (Treat mildew spots while they are fresh, before mold has a chance to weaken fabric.) If either type stain remains, bleach according to Stain Removal Hint on opposite page, launder. (Severe scorch cannot be removed.)	Sponge with warm water. Apply <i>undiluted liquid detergent</i> . Bleach remaining stain with non-chlorine bleach, then launder. Old mildew stains can seldom be removed. Scorch can seldom be removed.
Ink, Ballpoint	Fresh stains: Place stain face down on an absorbent towel and sponge with dry cleaning fluid,* or use spray cleaner. Apply undiluted liquid detergent. Old stains; bleach according to Stain Removal Hint on opposite page.	Same as white and bleachable fabrics except launder using non-chlorine bleach.
Paint and Varnish	Soften with oil, lard or Vaseline, then sponge with turpentine or banana oil. Launder in warm water.	Same as white and bleachable fabrics.
Perspiration	Apply undiluted liquid detergent and launder in warm water. If color has changed you may be able to restore it by treating with ammonia or vinegar.** If any stain remains, treat with safe dry cleaning fluid* or bleach according to Stain Removal Hint on opposite page, launder and dry.	Launder in warm water. Rinse well. Bleach with non-chlorine bleach.
Rust	Apply rust remover,** using manufacturer's directions. Rinse and launder.	Same as white and bleachable fabrics.

\*Caution: Because cleaning fluids tend to be toxic, be sure you are in a well ventilated room when using them. No cleaning fluid should be used unless user is familiar with the limitations and required cautions (usually printed on label). Use extreme caution with flammable compounds.

Under no circumstances should fabrics containing flammable materials (waxes, cleaning fluids, etc.) be washed in washer.

\*\*Do not mix chlorine bleach with ammonia or acids such as vinegar and/or rust remover. Mixing can produce a toxic gas which may cause death.

Save and refer to garment manufacturers' care labels.



## Questions? Use This Problem Solver

PROBLEM	POSSIBLE CAUSE AND REMEDY
LINT OR RESIDUE ON CLOTHES	<ul style="list-style-type: none"><li>• Incorrect sorting of clothes. Separate lint-producers (such as terry towels and chenille) from lint-receivers (such as man-made fabrics, velveteen, corduroy).</li><li>• Washing too long, especially for smaller loads. For normal soil, wash one minute per pound of dry clothes.</li><li>• Use of non-phosphate detergents which combine with hardness minerals to form a precipitate which can be mistaken for lint. Use a phosphate or liquid detergent; use warmer wash water or soften water with an installed mechanical softener or a packaged water softener.</li><li>• Powdery residue from granular detergent may appear to be lint. Predissolve granular detergent in hot water before adding to washer; make sure detergent is completely dissolved before adding clothes; switch to liquid or cold water detergent or use warmer wash water. See page 15.</li><li>• Overloading will cause abrasion which creates excessive lint. Wash fewer items with correct water level.</li><li>• Too much bleach. Use correct amount of bleach according to package directions.</li><li>• Not enough detergent to hold lint in suspension during wash cycle. Increase amount of detergent. See page 15.</li><li>• Incorrect use of fabric softener. If used in wash cycle, softeners may react with detergent to create a white deposit. Use softeners in rinse cycle only unless package specifies adding to wash cycle. Use Fabric Softener Dispenser. See page 8.</li><li>• Pilling usually on polyester-cotton blends is caused by normal wear and may look like lint. Turning clothes inside-out may help.</li><li>• Static electricity caused by overdrying will cause attraction. Use fabric softener in rinse cycle.</li></ul>
GREASY OR OILY STAINS ON LAUNDERED GARMENTS	<p>These are sometimes called "Invisible Stains" because you may not notice them before washing clothes. However, if oily soils are not completely removed in wash cycle, the oily spots may pick up dirt from the wash water. The spots will then be very visible. They are <i>not</i> caused by the washer. Wash synthetic garments as soon as possible after wearing. Use more detergent than normal and hottest water fabric can stand. If spots appear, rub in undiluted liquid detergent, let stand 30 minutes and rewash with extra detergent using hottest water fabric can stand.</p>

PROBLEM	POSSIBLE CAUSE AND REMEDY
<p><b>GRAYED CLOTHES</b></p>	<ul style="list-style-type: none"> <li>• Insufficient detergent. You may need to increase amount of detergent used if load is larger than normal, if soils are oily or heavier than average, if water level is large or if water is Hard to Extremely Hard.</li> <li>• Water not hot enough for type of load. Be sure water heater is set to deliver hot water at the washer at 140°-150°F. Do not wash when other hot water needs—such as dishwashing or family baths—are heavy.</li> <li>• Poor or inferior detergent. Change to phosphate detergent, if possible. Follow these steps:             <ol style="list-style-type: none"> <li>1. Use water conditioner, (such as Calgon brand)</li> <li>2. Pre-treat stains</li> <li>3. Use hottest water possible</li> <li>4. Use bleach where possible</li> <li>5. Use pre-soak aids</li> <li>6. Install water softener</li> </ol> </li> <li>• Washer overloaded. Clothes cannot move freely to loosen and remove soil, causing gray appearance. Follow correct loading procedures for size of load.</li> <li>• Improper soaking with insufficient detergent. Usually a 30-minute soak is sufficient. However, when using extended soaks for heavily soiled garments you may need to use twice the recommended amount of detergent.</li> <li>• Use of soap in hard water. Switch to a phosphate detergent, or follow six steps described above.</li> <li>• Washing too long may result in increased soil deposition. Use shorter wash times for smaller loads.</li> <li>• Detergent dissolves too slowly. Detergent must be present in the wash solution at the start of agitation. See page 15.</li> <li>• To restore grayed clothes, follow one of these procedures:             <ol style="list-style-type: none"> <li>1. Put clothes in washer. Fill with HOT water. Check Manufacturers' Care Labels to determine if hot water is suitable for garment.                 <ul style="list-style-type: none"> <li>• Add a non-precipitating type of water softener such as Calgon with phosphate—use 2½ times as much as you need for normal water softening.</li> <li>• Do not use detergent or soap.</li> <li>• Allow clothes to go through complete cycle.</li> <li>• Repeat, if necessary.</li> </ul> </li> <li>2. If you prefer to use the Soak Setting, see page 8. Use the water softener in place of soak agent or prewash detergent and allow clothes to soak for about 20 minutes.</li> <li>3. Use the Mini-Basket tub. See page 9. Increase detergent.</li> </ol> </li> </ul>
<p><b>YELLOWED CLOTHES</b></p>	<ul style="list-style-type: none"> <li>• Incomplete removal of body soil due to constant use of insufficient detergent. Check hem of T-shirt or pillow case. If they are white and center is yellow, it contains body oil. Restore whiteness following procedures on "Grayed Clothes," page 21.</li> </ul>

(continued next page)

# The Problem Solver (continued)

PROBLEM	POSSIBLE CAUSE AND REMEDY
<p>YELLOWED CLOTHES (continued)</p>	<ul style="list-style-type: none"> <li>• Chlorine bleach may yellow some fabrics with resin finishes. Use oxygen bleach (such as Clorox 2 brand). Refer to Garment Manufacturers' Care Instructions. Restore color using color remover (such as Rit or Tintex brands), follow package directions.</li> <li>• Iron or manganese in water may cause overall yellowing or yellow spots.               <ol style="list-style-type: none"> <li>1. Use extra detergent plus a non-precipitating water softener dissolved in water before adding clothes. Use non-chlorine bleach.</li> <li>2. Have a special filter or chemical feeder installed in your home to remove iron and manganese from water.</li> <li>3. Run hot water for a few minutes to clean iron residue buildup in lines; drain water heater occasionally.</li> <li>4. <b>To remove spots:</b> spread stained portion over pan of boiling water and squeeze lemon juice through stain. <b>To remove overall yellow,</b> use a commercially available rust scale remover, following package instructions. If porcelain damage can occur, do not use in the washer; use a plastic container.</li> </ol> </li> </ul>
<p>BLUE OR GRAY COLOR STAINS</p>	<ul style="list-style-type: none"> <li>• Improper use of fabric softener. Never pour fabric softener directly on clothes; always dilute before adding to rinse water. Dilute softener before filling your Fabric Softener Dispenser. (See page 8.) Also, do not lift lid during spin. This may cause improper dispensing, resulting in stains. <b>To remove stains:</b> dampen stained area and rub with undiluted liquid detergent. Re-wash, using chlorine bleach if safe for fabric.</li> </ul>
<p>SHRINKAGE, GENERAL</p>	<ul style="list-style-type: none"> <li>• Some fabrics will shrink whether washed in a washer or by hand; others may be safely washed but will shrink in a dryer. Follow Garment Manufacturers' Care Instructions exactly. If in doubt, do not machine wash or dry.</li> </ul>
<p>SHRINKAGE, KNITS</p>	<ul style="list-style-type: none"> <li>• <b>Relaxation shrinkage</b> can occur in knit fabrics that have been improperly stretched and elongated by the manufacturer. When this occurs, garment may be pressed back into shape after each wash and dry cycle.</li> <li>• <b>Progressive or delayed shrinkage</b> is caused when starch or sizing (in some fabrics) is gradually removed by laundering. May be noticed in older garments that have been washed many times without previous shrinkage. Treat as for Relaxation Shrinkage above.</li> <li>• <b>Shrinkage caused by overheating</b> occurs in certain knit fabrics that have been heat-shaped. When washing, drying or ironing temperatures exceed the temperatures used to shape set, shrinkage may occur. This cannot be corrected, but it can be prevented by washing in cool or warm water; drying on Low or Delicate heat.</li> </ul>

PROBLEM	POSSIBLE CAUSE AND REMEDY
<b>WRINKLING IN PERMANENT PRESS AND "NO-IRON" ITEMS</b>	<ul style="list-style-type: none"> <li>• Leaving clothes in dryer after tumbling stops. Remove and hang clothes immediately.</li> <li>• Too many clothes in dryer. Dry only one washer load at a time. Do not combine loads.</li> <li>• Improper loads. Avoid laundering heavy Permanent Press items, such as work clothes, with lighter Permanent Press items such as shirts or blouses. Do not wash Permanent Press with regular laundry.</li> <li>• Too many clothes in washer. Permanent Press loads should always be smaller than regular loads. . . no more than medium loads to give clothes room to move freely.</li> <li>• Incorrect wash and dry cycles. Use Permanent Press Wash cycle which provides a cooldown rinse to minimize wrinkling. Also use Permanent Press Dry cycle.</li> <li>• Incorrect water level. Use Extra Large Water Level for Medium Load, Medium Level for Small Load.</li> <li>• Repeated washing in too hot water. Wash in cold or warm water with plenty of detergent.</li> <li>• Accumulation of lime scale due to use of carbonate detergents. If you must use a non-phosphate detergent, avoid the use of high-carbonate-built detergent.</li> <li>• Failure to use fabric softener. Proper use will minimize wrinkling.</li> </ul> <p><b>To remove wrinkles:</b></p> <ol style="list-style-type: none"> <li>1. Retumble on "Permanent Press" setting.</li> <li>2. Rerinse and dry on "Permanent Press" setting.</li> <li>3. If unsuccessful, retumble on high heat for 10-12 minutes and hang immediately.</li> <li>4. Iron carefully.</li> <li>5. Send to dry cleaners for pressing.</li> <li>6. Some wrinkles may remain which cannot be removed.</li> </ol>
<b>SNAGS, HOLES, TEARS, RIPS OR EXCESSIVE WEAR</b>	<ul style="list-style-type: none"> <li>• Pins on garments or sharp objects left in pockets. Check to make sure all such objects are removed. Also check wash tub.</li> <li>• Snaps, hooks, sharp buttons, belt buckles, zippers. Fasten hooks, zippers and buttons. Remove sharp buttons and belt buckles. This is especially important in washing knits which snag easily. Turn knits inside out.</li> <li>• Holes with random square shapes with yellow discoloration may be caused by improper use of chlorine bleach. Use only correct amount of bleach, using Bleach Dispenser. Never add undiluted bleach to wash tub or allow clothes to come into contact with undiluted bleach. Do not wipe up bleach spills with clothes.</li> <li>• Chemicals such as hair bleach, dye, permanent wave solutions, battery acids and toilet bowl cleaners may cause fabric holes. Rinse all towels and other articles that came in contact with these chemicals before putting them in wash. Do not contaminate clothing articles with these chemicals.</li> <li>• Small, unnoticed tears may enlarge during washing process. Check garments before washing and mend all rips and tears.</li> </ul>

(continued next page) 

# The Problem Solver (continued)

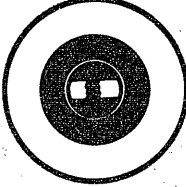
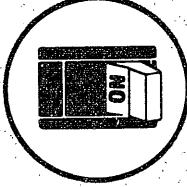
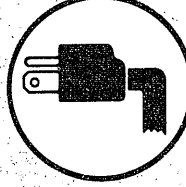
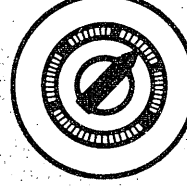
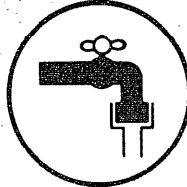
PROBLEM	POSSIBLE CAUSE AND REMEDY
<p>SNAGS, HOLES, TEARS, RIPS OR EXCESSIVE WEAR (continued)</p>	<ul style="list-style-type: none"> <li>• As Permanent Press garments age, they may show fraying at collars and cuffs. This is normal due to weakening of fibers by the Permanent Press process. It is not caused by washer. You can slow this process by washing small Permanent Press loads with a Large Water Level. Do not wash heavy items such as towels with Permanent Press. Remove collar stays, when possible.</li> <li>• Roughness or burrs on agitator may cause rips or tears. Check agitator and file rough spots if necessary.</li> <li>• May be caused by use of Normal Wash/Spin speed for delicate articles. Use Gentle Wash/Spin speed. Refer to Garment Manufacturers' Care Labels.</li> <li>• Garments weakened by age, sun or atmosphere. This is inevitable and is not caused by washer. Slow process by washing on Gentle Wash/Spin speed.</li> <li>• Too large loads, or too little water. Load washer only with number of items that will move freely. Select correct water level.</li> </ul>
<p>HEAVILY SOILED AREAS such as collars and cuffs</p>	<ul style="list-style-type: none"> <li>• Pretreat with liquid detergent.</li> </ul>
<p>WASHER WON'T OPERATE</p>	<div style="display: flex; justify-content: space-around; align-items: center;">     </div> <ul style="list-style-type: none"> <li>• Make sure cord is plugged into outlet.</li> <li>• Make sure both hot and cold faucets are turned on.</li> <li>• Make sure controls are set and cycle selector knob is pulled out to ON position.</li> <li>• Make sure lid is closed. Washer will fill but will not spin or agitate with lid open.</li> <li>• Check house fuses or circuit breakers. If another appliance is sharing the electrical outlet, remove it. Washer should have separate outlet.</li> </ul>
<p>WATER TEMPERATURE IS INCORRECT</p>	<ul style="list-style-type: none"> <li>• Make sure temperature selector controls are properly set.</li> <li>• Make sure hot and cold faucets are turned on and regulated correctly.</li> <li>• Make sure hoses are connected to correct faucets . . . hot to hot, cold to cold.</li> <li>• Water valve screens may be stopped up. Remove inlet hoses from water valve. Clean the screens and reinstall hoses.</li> <li>• Check household water heater to make sure it is delivering water at 140° to 150°F.</li> </ul> <div style="text-align: right;">  </div>

PROBLEM	POSSIBLE CAUSE AND REMEDY
WATER WON'T DRAIN	<ul style="list-style-type: none"> <li>• Make sure drain hose is not kinked.</li> <li>• Top of drain outlet should be less than 8 ft. above floor.</li> </ul>
WATER LEAKS	<ul style="list-style-type: none"> <li>• Make sure hose connections are tight at faucets.</li> <li>• Make sure end of drain hose is correctly inserted in and secured to drain facility.</li> </ul>
WASHER IS NOISY	<ul style="list-style-type: none"> <li>• Make sure washer is level and firm to the floor with rubber foot pads in place and front jam nuts tight. See your Installation Instructions.</li> <li>• A sharp distinctive sound will be heard at the end of each spin period as the motor stops and the spin brake inside the transmission "locks in." This sound is normal.</li> <li>• Heavily unbalanced loads can cause the washer to vibrate excessively during spin, and may cause it to move from its original position. In extreme cases, (usually occurs when washing a single, heavy item or a small load when water level is set higher than necessary) the spin basket may strike the outer tub, creating a loud but harmless noise. To correct, open the lid and redistribute the load evenly about the wash basket. Close the lid and restart.</li> </ul>
WASHER PAUSES IN CYCLE	<ul style="list-style-type: none"> <li>• Washer normally pauses between washing steps . . . such as between wash and spin or between spin and rinse.</li> </ul>

**If you need more help...call, toll free:**  
**The GE Answer Center®**  
**800.626.2000**  
**consumer information service**

# Care and Cleaning

## USER MAINTENANCE INSTRUCTIONS

**The tub.** The porcelain is self-cleaning. Leave lid open after washing to *allow moisture to evaporate*. Do not use harsh or gritty cleansers.

**The exterior.** Wipe off any spills of washing compounds. Wipe or dust with damp cloth. Try not to hit surface with sharp objects.

### To store washer:

Ask service technician to remove water from drain pump and hoses to prevent freezing.

Do not store the washer where it will be exposed to the weather.

### For long vacations:

Be sure water supply is shut off at faucets and drain all water from hoses if weather will be below freezing.

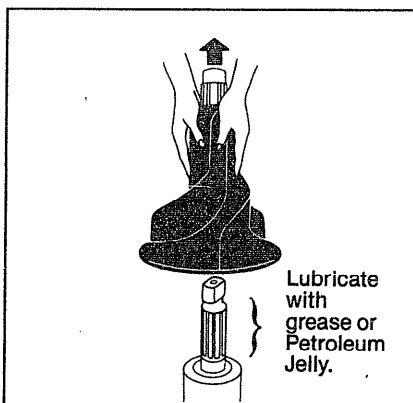

**The Activator® agitator.** Remove at regular intervals—about 4 to 6 months—and remove any lint that may have accumulated. No tools are needed, simply grasp agitator with both hands and pull straight up sharply. The slotted section at the top of the metal shaft has a light coating of lubricant to prevent parts sticking together. If this area appears to be dry, apply a light coat of grease or petroleum jelly around the slotted section of the shaft before replacing the agitator. Do not overgrease. Excess grease may get into clothes load.

When replacing the agitator, carefully lower straight down onto the shaft so that it fits into the slots. Then apply downward pressure until agitator snaps into its normal position.

## How to remove limestone deposits from clogged Filter Flo® pan

- Soak filter pan in a preheated 160°F. (71°C.) solution of half vinegar and half water for 15 minutes. Then brush each side of pan with a stiff bristle brush while flushing with running water.

### CAUTIONS:

- Do not soak in porcelain container. Vinegar can damage porcelain.
- Do not exceed 180°F. (82°C.) or filter pan may warp.

# If You Need Service

To obtain service, see your warranty on the back page of this book.

We're proud of our service and want you to be pleased. If for some reason you are not happy with the service you receive, here are three steps to follow for further help.

**FIRST**, contact the people who serviced your appliance. Explain why you are not pleased. In most cases, this will solve the problem.

**NEXT**, if you are still not pleased, write all the details—including your phone number—to:

Manager, Consumer Relations  
General Electric  
Appliance Park  
Louisville, Kentucky 40225

**FINALLY**, if your problem is still not resolved, write:

Major Appliance  
Consumer Action Panel  
20 North Wacker Drive  
Chicago, Illinois 60606

# YOUR GENERAL ELECTRIC AUTOMATIC CLOTHES WASHER WARRANTY

Save proof of original purchase date such as your sales slip or cancelled check to establish warranty period.

## WHAT IS COVERED

### FULL ONE-YEAR WARRANTY

For one year from date of original purchase, we will provide, free of charge, parts and service labor in your home to repair or replace **any part of the washer** that fails because of a manufacturing defect.

### LIMITED ADDITIONAL FOUR-YEAR WARRANTY

For the second through fifth year from date of original purchase, we will provide, free of charge, replacement parts for **any part of the transmission** that fails because of a manufacturing defect. You pay for the service trip to your home and service labor charges. Or, if you desire, we will provide a **completely reconditioned transmission**. You pay for the shop reconditioning labor, the service trip to your home and service labor charges.

This warranty is extended to the original purchaser and any succeeding owner for products purchased for ordinary home use in the 48 mainland states, Hawaii and Washington, D.C. In Alaska the warranty is the same except that it is LIMITED because you must pay to ship the product to the service shop or for the service technician's travel costs to your home.

All warranty service will be provided by our Factory Service Centers or by our authorized Customer Care® servicers during normal working hours.

Look in the White or Yellow Pages of your telephone directory for GENERAL ELECTRIC COMPANY, GENERAL ELECTRIC FACTORY SERVICE, GENERAL ELECTRIC-HOTPOINT FACTORY SERVICE or GENERAL ELECTRIC CUSTOMER CARE® SERVICE.

## WHAT IS NOT COVERED

- Service trips to your home to teach you how to use the product.

### Read your Use and Care material.

If you then have any questions about operating the product, please contact your dealer or our Consumer Affairs office at the address below, or call, toll free:

The GE Answer Center®  
800.626.2000  
consumer information service

- Improper installation.

If you have an installation problem, contact your dealer or installer. You are responsible for providing adequate electrical, plumbing and other connecting facilities.

- Replacement of house fuses or resetting of circuit breakers.

- Failure of the product if it is used for other than its intended purpose or used commercially.

- Damage to product caused by accident, fire, floods or acts of God.

WARRANTOR IS NOT RESPONSIBLE FOR CONSEQUENTIAL DAMAGES.

Some states do not allow the exclusion or limitation of incidental or consequential damages, so the above limitation or exclusion may not apply to you. This warranty gives you specific legal rights, and you may also have other rights which vary from state to state. To know what your legal rights are in your state, consult your local or state consumer affairs office or your state's Attorney General.

**Warrantor: General Electric Company**

**If further help is needed concerning this warranty, write:**

**Manager—Consumer Affairs, General Electric Company, Appliance Park, Louisville, KY 40225**

Part No. 113D5497P021  
Pub. No. 49-9548

GENERAL  ELECTRIC

WWA8364V