

This Owner's Manual is provided and hosted by [Appliance Factory Parts](#).

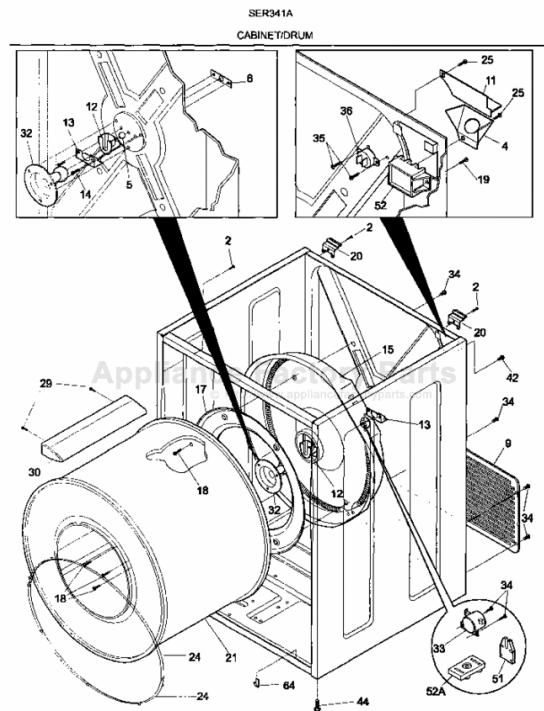

# WESTINGHOUSE SER341AS1 Owner's Manual

[Shop genuine replacement parts for WESTINGHOUSE  
SER341AS1](#)



[Find Your WESTINGHOUSE Dryer Parts - Select From 2 Models](#)

----- Manual continues below -----

---

# OWNER'S GUIDE

---

READ AND SAVE THESE INSTRUCTIONS

**DRYER**

**⚠ WARNING** For your safety, the information in this manual must be followed to minimize the risk of fire or explosion or to prevent property damage, personal injury or loss of life.

- Do not store or use gasoline or other flammable vapors and liquids in the vicinity of this or any other appliance.
- **WHAT TO DO IF YOU SMELL GAS:**
  - Do not try to light any appliance.
  - Do not touch any electrical switch; do not use any phone in your building.
  - Clear the room, building or area of all occupants.
  - Immediately call your gas supplier from a neighbor's phone. Follow the gas supplier's instructions.
  - If you cannot reach your gas supplier, call the fire department.

Installation and service must be performed by a qualified installer, service agency or the gas supplier.

## Contents

Product Registration .....	2
Important Safety Instructions .....	2-3
Drying Procedures .....	4
Features .....	5
Common Drying Problems .....	5
Care and Cleaning .....	6
Avoid Service Checklist .....	7

## Product Registration

**Thank you for choosing this dryer.**

This owner's guide will explain proper operation and care.

### Record Your Model and Serial Numbers

Record below the model and serial numbers found on the dryer serial plate located on the left side of the door opening. Keep these numbers for future reference.

Model Number \_\_\_\_\_

Serial Number \_\_\_\_\_

Date of Purchase \_\_\_\_\_

### Register Your Product

The self-addressed **PRODUCT REGISTRATION CARD** should be filled in completely, signed and returned.

## Important Safety Instructions

**Read all instructions before using this dryer.**

**⚠ WARNING** To reduce the risk of fire, electrical shock, or injury to persons when using this dryer, comply with the basic warnings listed below.

**⚠** Failure to comply with these warnings could result in serious personal injuries.

### Prevent Fire

**⚠ WARNING** Do not dry items that have been previously cleaned in, soaked in, or spotted with gasoline, cleaning solvents, kerosene, waxes, etc. Do not store these items on or near the dryer. These substances give off vapors that could ignite or explode.

**⚠ WARNING** To prevent fire, do not use heat to dry items containing plastic, foam rubber or similarly textured rubber-like materials, or items containing feathers or down. Use Air Fluff (No Heat) only.

**⚠ WARNING** Clean the lint screen before or after each load. The interior of the dryer, lint screen housing and exhaust duct should be cleaned approximately every 18 months by qualified service personnel. An excessive amount of lint build-up in these areas could result in inefficient drying and possible fire. See **Care and Cleaning**, page 6.

**⚠ WARNING** Do not operate the dryer if the lint screen is blocked, damaged or missing. Fire hazard, overheating and damage to fabrics can occur. If your dryer has a drying rack, always replace the lint screen when finished using the drying rack.

**⚠ WARNING** Keep area around the exhaust opening and surrounding areas free from the accumulation of lint, dust and dirt.

**⚠ WARNING** Do not obstruct the flow of ventilating air. Do not stack or place laundry or throw rugs against the front or back of the dryer.

**⚠ WARNING** Do not spray any type of aerosol into, on or near dryer at any time.

**⚠ WARNING** Do not use fabric softeners or products to eliminate static unless recommended by the manufacturer of the fabric softener or product.

**⚠ WARNING** Do not place items exposed to cooking oils in your dryer. Items contaminated with cooking oils may contribute to a chemical reaction that could cause a load to catch fire.

**⚠** Failure to comply with these warnings could result in fire, explosion, serious bodily injury and/or damage to the rubber or plastic parts of the dryer.

This Owner's Guide provides general operating instructions for your dryer. It also contains information about features for several other models. Your dryer may not have every feature included.

Use the dryer only as instructed in this Owner's Guide and the **Operating Instructions** card included with your dryer.

**⚠ WARNING** Avoid fire hazard or electrical shock. Do not use an adaptor plug or extension cord or remove grounding prong from electrical power cord. Failure to follow this warning can cause serious injury, fire or death.

### **ELECTRIC DRYERS:**

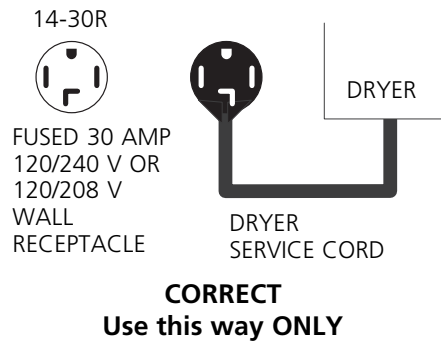

### **GAS DRYERS:**

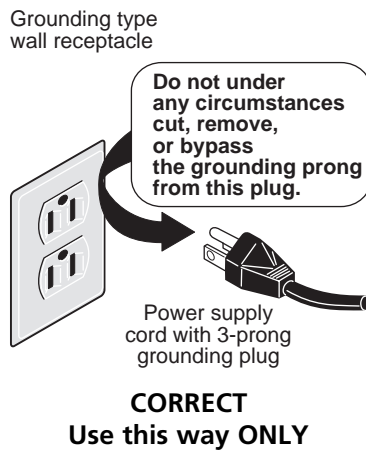

**Note:** The instructions appearing in this Owner's Guide are not meant to cover every possible condition and situation that may occur. Common sense and caution must be practiced when installing, operating and maintaining any appliance.

## **Protect Children**

**⚠ WARNING** Do not allow children to play on or in the dryer. Close supervision of children is necessary when the dryer is used near children. As children grow, teach them the proper, safe use of all appliances.

**⚠ WARNING** Destroy the carton, plastic bag and other packing materials after the dryer is unpacked. Children might use them for play. Cartons covered with rugs, bedspreads or plastic sheets can become airtight chambers.

**⚠ WARNING** Keep laundry products out of children's reach. To prevent personal injury, observe all warnings on product labels.

**⚠ WARNING** Before the dryer is removed from service or discarded, remove the dryer door to prevent accidental entrapment.

**⚠** Failure to comply with these warnings could result in serious personal injuries.

## **Prevent Injury**

**⚠ WARNING** To prevent shock hazard and assure stability during operation, the dryer must be installed and electrically grounded by a qualified service person in accordance with local codes. Installation instructions are packed in the dryer for the installer's reference. Refer to INSTALLATION INSTRUCTIONS for detailed grounding procedures. If the dryer is moved to a new location, have it checked and reinstalled by a qualified service person.

**⚠ WARNING** To prevent personal injury or damage to the dryer, the electrical power cord of a gas dryer must be plugged into a properly grounded and polarized 3-prong outlet. **The third grounding prong must never be removed. Never ground the dryer to a gas pipe. Do not use an extension cord or an adaptor plug.**

**⚠ WARNING** **ALWAYS disconnect** the dryer from the electrical supply before attempting any service or cleaning. Failure to do so can result in electrical shock or injury.

**⚠ WARNING** Do not use any type spray cleanser when cleaning dryer interior. Hazardous fumes or electrical shock could occur.

**⚠ WARNING** To prevent injury, do not reach into the dryer if the drum is moving. Wait until the dryer has stopped completely before reaching into the drum.

**⚠ WARNING** To prevent injury and damage to the dryer:

- **All repairs and servicing must be performed by an authorized servicer** unless specifically recommended in this Owner's Guide. Use only authorized factory parts.
- **Do not** tamper with controls.
- **Do not** install or store the dryer where it will be exposed to the weather.

**⚠** A thermal limiter switch automatically turns off the motor in the unlikely event of an overheated situation (electric dryers only). A service technician must replace the thermal limiter switch after correcting the fault.

**⚠** Failure to comply with these warnings could result in serious personal injuries.

**SAVE THESE INSTRUCTIONS**

# Drying Procedures

- Follow the guidelines below for preparing the load for drying.
- Read the **Operating Instructions** card for operating your specific model.
- **Always read and follow fabric care labels and laundry product labels.**

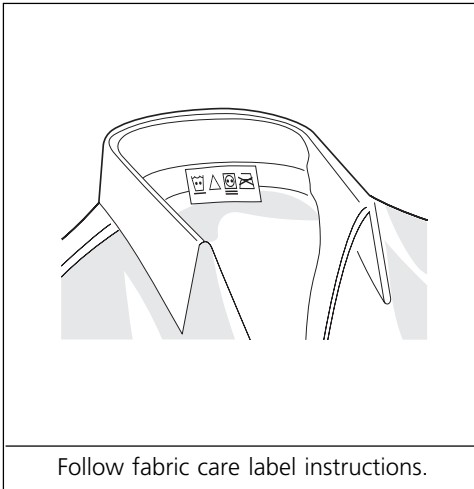

**! WARNING** To reduce the risk of fire, electrical shock, or injury to persons, read **Important Safety Instructions**, pages 2-3, before operating this dryer.

## 1. Prepare items for drying.

- Dry items of similar fabric, weight and construction in the same load.
- Separate dark items from light-colored items. Separate items that shed lint from those that attract lint. If an item sheds lint, turn it inside out.
- Be sure buckles, buttons and trim are heatproof and won't damage the drum finish. Close zippers, fasten hooks and Velcro®-like fasteners. Tie strings and sashes to prevent snagging and tangling.
- If possible, turn pockets inside out for even drying.
- Check for stains which may not have been removed in washing. Dryer heat may permanently set some stains. Repeat stain removal process before drying.
- Place small items in a mesh bag to prevent tangling and for easy removal.

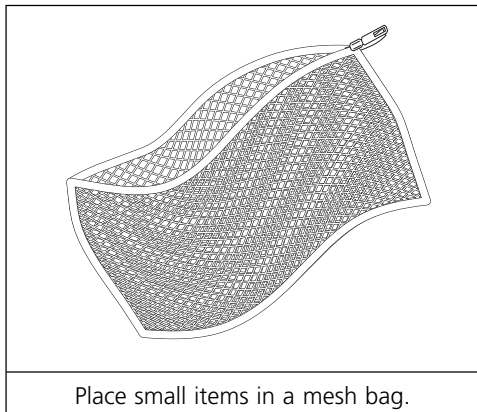

## 2. Check that lint screen is clean and in place.

## 3. Load the dryer.

- The average load will fill the drum 1/3 to 1/2 full. Items need room to tumble freely for even drying and less wrinkling. **Do not overload dryer.**
- When drying large items, dry only 2 or 3 at a time. Fill out the load with small and medium sized items.
- For delicate or very small loads, add 2 lint-free towels for better drying, less wrinkling, and to prevent grease stains caused by fabric softener sheets.
- Do not overdry items. Overdrying can cause wrinkling, shrinkage, harshness, and a build-up of static electricity, which can produce more lint.
- If desired, add a dryer fabric softener sheet.

## 4. Close the dryer door and set dryer controls (some models).

See **Operating Instructions** card for your specific model controls.

## 5. Turn cycle selector clockwise to the desired setting.

## 6. Start the dryer.

- Push Start Button for 2 seconds or turn the START knob clockwise to ON, hold for 1-2 seconds and release.
- To add or remove items when the dryer is running, open the door. The dryer will always stop when the door is opened. Allow the drum to come to a complete stop before reaching inside.
- To restart dryer, close the door then push the Start Button for 2 seconds or turn the START knob clockwise to ON, hold for 1-2 seconds and release.
- The dryer will not start if the cycle selector is in the OFF position.



## 7. When the cycle ends, remove items immediately and hang or fold. If load is removed before the cycle ends, turn cycle selector to OFF.

# Features

## Cycle Signal Control (some models)

When the Cycle Signal Control is ON, a signal will sound at the end of each cycle and during the Press Saver setting (some models). The volume is adjustable on some models.

## Drum Light (some models)

A drum light will come on whenever the door is opened to illuminate the dryer drum during loading and unloading. Closing the door turns off the light.

## Reversible Dryer Door

Your dryer is equipped with a reversible door. The door can be hinged on the right or left side. Refer to the INSTALLATION INSTRUCTIONS for directions on changing the door.

## Drying Rack (some models)

Use the drying rack to dry items which should not be tumble dried.

1. Open the dryer door and remove the lint screen.
2. Insert drying rack into the dryer drum. Place the front bar under the lip of the lint screen opening.
3. Place items to be dried on top of the rack. Weight should not exceed 10 lbs. Leave space between items, but do not let items hang over the sides or through the grids. Do not tumble other items when using the drying rack.
4. Select a timed dry setting best suited for items being dried. Use only the Air Fluff (no heat) temperature setting for items containing plastic, foam rubber, rubber-like materials, feathers or down.
5. When items are dry, remove the rack and replace the lint screen. If lint screen is not in place, tumbling items could enter the exhaust system and cause damage to the dryer.

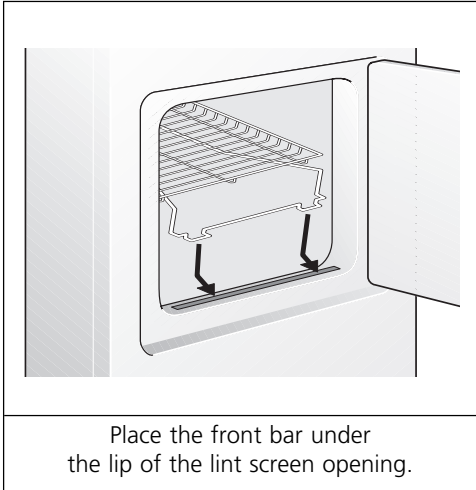

# Common Drying Problems

Many drying problems involve poor cleaning results, poor soil and stain removal, residues of lint and scum, and fabric damage. For satisfactory drying results, follow these suggestions provided by The Soap and Detergent Association.

PROBLEM	POSSIBLE CAUSES	SOLUTIONS	PREVENTIVE MEASURES
<b>Greasy, oily stains</b>	<ul style="list-style-type: none"> <li>• Fabric softener sheet.</li> </ul>	<ul style="list-style-type: none"> <li>• Rub fabric softener stains with bar soap. Rinse and rewash.</li> </ul>	<ul style="list-style-type: none"> <li>• Add a few bath towels to small loads for proper tumbling.</li> <li>• Some "silk-like" fabrics should be air dried.</li> <li>• Use proper drying temperature.</li> <li>• Place fabric softener sheet on top of load before starting the dryer.</li> </ul>
<b>Lint</b>	<ul style="list-style-type: none"> <li>• Overloading.</li> <li>• Overdrying causes static electricity.</li> <li>• Lint screen not clean when cycle began.</li> <li>• Lint is attached to "pills."</li> </ul>	<ul style="list-style-type: none"> <li>• Reduce load size and rewash using liquid fabric softener in the final rinse.</li> <li>• Or, add a fabric softener sheet and tumble without heat.</li> <li>• Use lint brush or roller to remove lint.</li> </ul>	<ul style="list-style-type: none"> <li>• Do not overload dryer.</li> <li>• Use fabric softener in washer or dryer to reduce static electricity.</li> <li>• Remove items when they are slightly damp to avoid overdrying.</li> <li>• Check that lint screen is clean and in place.</li> </ul>
<b>Pilling</b> (Fibers break off, ball up and cling to fabric.)	<ul style="list-style-type: none"> <li>• Pilling is normal with synthetic and permanent press fabrics. This is due to abrasion from normal wear.</li> </ul>	<ul style="list-style-type: none"> <li>• Use a lint brush or shaver to remove pills.</li> </ul>	<ul style="list-style-type: none"> <li>• Use fabric softener to lubricate fibers.</li> <li>• When ironing, use spray starch or fabric finish on collars and cuffs.</li> <li>• Turn items inside out to reduce abrasion.</li> </ul>
<b>Shrinking</b>	<ul style="list-style-type: none"> <li>• Overdrying.</li> </ul>	<ul style="list-style-type: none"> <li>• Irreversible condition.</li> </ul>	<ul style="list-style-type: none"> <li>• Follow fabric care label directions.</li> <li>• If shrinking is a concern, check load often.</li> <li>• Remove items while slightly damp and hang or lay flat to complete drying.</li> <li>• Block knits into shape.</li> </ul>
<b>Wrinkling</b>	<ul style="list-style-type: none"> <li>• Overloading.</li> <li>• Leaving items in dryer after cycle ends.</li> </ul>	<ul style="list-style-type: none"> <li>• Reduce load size and tumble at medium or low heat for 5-10 minutes.</li> <li>• Remove items immediately. Hang or fold.</li> </ul>	<ul style="list-style-type: none"> <li>• Do not overload dryer.</li> <li>• Remove items as soon as cycle ends.</li> </ul>

## Care and Cleaning

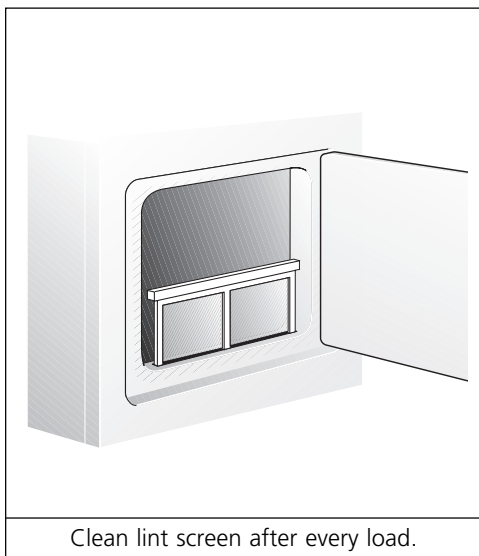

**! WARNING** To reduce risk of fire or serious injury to persons or property, comply with the basic warnings listed in **Important Safety Instructions**, pages 2-3, and those listed below.

- Before cleaning the dryer interior, **unplug the electrical power cord** to avoid electrical shock hazards.
- Do not use any type spray cleanser when cleaning dryer interior. Hazardous fumes or electrical shock could occur.

### Inside

- Clean the lint screen after every load. Lint build-up in the screen restricts air flow, which causes longer drying times. The screen is located at the bottom of the door opening. Remove by pulling straight up. Remove the lint and replace the screen.
- Occasionally a waxy build-up may form on the lint screen from using dryer-added fabric softener sheets. To remove this build-up, wash the lint screen in warm, soapy water. Dry thoroughly and replace. Do not operate the dryer without the lint screen in place.
- If the dryer drum becomes stained from noncolorfast fabrics, clean the drum with a damp cloth and a mild liquid household cleanser. Remove cleanser residue before drying the next load.
- Every 18 months an authorized servicer should clean the dryer cabinet interior and exhaust duct. These areas can collect lint and dust over time. An excessive amount of lint build-up could result in inefficient drying and possible fire hazard.

### Outside

- Clean the cabinet with mild soap and water. **Never use harsh, gritty or abrasive cleansers.**
- If the cabinet becomes stained, clean with diluted chlorine bleach [1/2 cup (120 ml) in 1 quart (.95 liter) water]. Rinse several times with clear water.
- Remove glue residue from tape or labels with a mixture of warm water and mild detergent. Or, touch residue with the sticky side of the tape or label.
- **Before moving the dryer**, place a strip of cardboard or thin fiberboard under the front leveling legs to prevent damage to floor.

# Avoid Service Checklist

Before calling for service, review this list. It may save both time and expense. The list includes common occurrences that are not the result of defective workmanship or materials in this dryer.

OCCURRENCE	POSSIBLE CAUSE	SOLUTION
<b>Dryer does not start.</b>	Electrical power cord is not securely plugged in or plug may be loose.	Make sure the plug fits tightly in wall outlet.
	House fuse blown or circuit breaker tripped.	Reset circuit breaker or replace fuse.  Make sure electrical line is not overloaded and the dryer is on a separate circuit.
	Thermal limiter tripped.	Call authorized service person for replacement.
<b>Dryer runs but won't heat.</b>	There are 2 house fuses in the dryer circuit. If 1 of the 2 fuses is blown, the drum may turn but the heater will not operate.	Replace fuse.
	Gas supply valve is not open (gas models).	Check to make sure supply valve is open. See INSTALLATION INSTRUCTIONS for procedure.
	Dryer does not have enough air supply to support the burner flame (gas models).	See INSTALLATION INSTRUCTIONS.
	LP gas supply tank is empty or there has been a utility interruption of natural gas (gas models).	Refill or replace tank.  Dryer should heat when utility service is restored.
<b>Drying cycle takes too long, outside of the dryer feels too hot or smells hot.</b>	Lint screen is clogged with lint.	Make sure all lint has been removed from the dryer lint screen before starting each cycle.
	Exhaust duct requirements have not been met.	Exhaust duct must be at least 4 inches in diameter and made of rigid or flexible metal.  When in place, the duct must have no more than two 90° bends and must not exceed length listed in INSTALLATION INSTRUCTIONS.
	Electric dryer is connected to a 208 volt circuit.	Drying time will be 20% longer than drying on a 240 volt circuit.
	Drying procedures have not been followed.	See <b>Drying Procedures</b> , page 4.
	Outside exhaust hood or exhaust duct may be clogged or restricted.	Clean out any obstruction.
	High humidity.	Use a dehumidifier near the dryer.
	<b>Excessive wrinkling.</b>	Dryer is overloaded.
Items left in dryer too long.		Remove items as soon as cycle ends.
Insufficient sorting of items.		See <b>Drying Procedures</b> , page 4.
Drying temperature too high.		Follow fabric care label instructions.
<b>Scratching or chipping of the drum finish.</b>	Foreign objects such as coins, pins, clips or buttons are inside the dryer.	Always remove foreign objects from pockets before laundering. Remove objects from drum and restart dryer.
	Permanently attached items such as belt buckles, zippers and fasteners may be hitting the inside of the drum.	It may be necessary to baste a scrap of material securely around ornaments before drying to prevent scratching and damage to the dryer.  <b>Drum damage caused by foreign objects or permanently attached items is not covered by the warranty.</b>

---

This Page Not Required