

This Owner's Manual is provided and hosted by [Appliance Factory Parts](#).

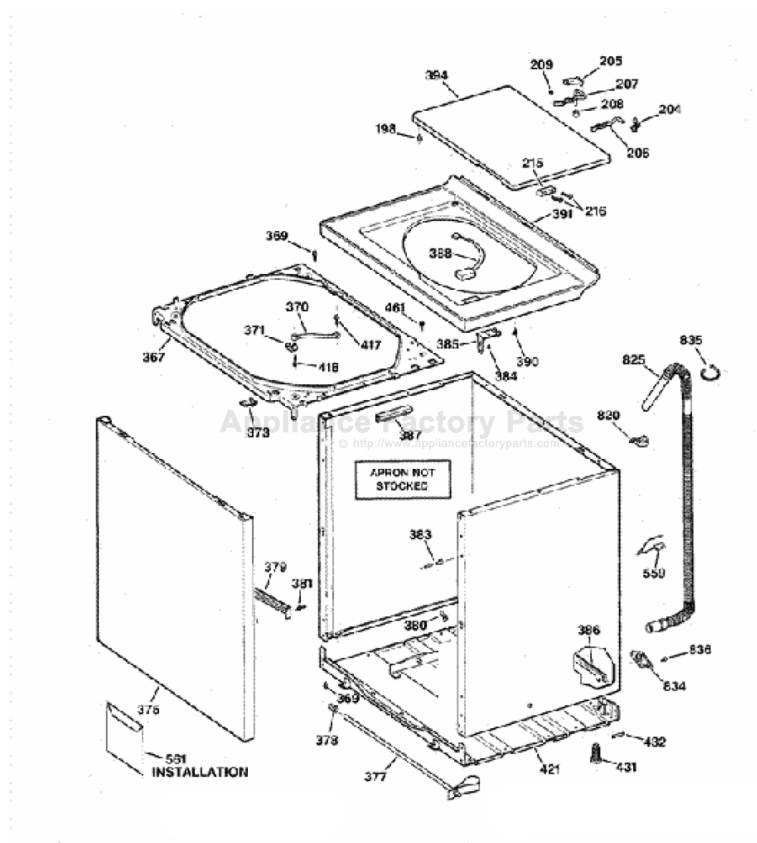

GE WCSE3100A0WW Owner's Manual

[Shop genuine replacement parts for GE
WCSE3100A0WW](#)



[Find Your GE Washer Parts - Select From 4591 Models](#)

----- Manual continues below -----



GE Appliances

Washers



Owner's Manual

- WBSE2090**
- WBXE2070**
- WCSE3100**
- WCSE4230**
- WJSE3110**
- WWSE3160**



GE Answer Center® 800.626.2000

www.geappliances.com

Part No. 175D1807P297 Pub. No. 49-90030 1-00 JR

Safety Information3

Operating Instructions
 Control Panels4-6
 Features7
 Loading and Using the Washer8, 9

Troubleshooting Tips
 Before You Call For Service . . . 10-12

Customer Service
 Product Registration13, 14
 Warranty15
 Service Telephone NumbersBack Cover

Congratulations! You Are Now Part of the GE Family.

Welcome to the GE family. We're proud of our quality products and we are committed to providing dependable service. You'll see it in this easy-to-use Owner's Manual and you'll hear it in the friendly voices of our customer service department.

Best of all, you'll experience these values each time you use your washer. That's important, because your new washer will be part of your family for many years. And we hope you will be part of ours for a long time to come.

We thank you for buying GE. We appreciate your purchase, and hope you will continue to rely on us whenever you need quality appliances for your home.

A Service Partnership.



IMPORTANT!

Staple sales slip or cancelled check here.

Proof of the original purchase date is needed to obtain service under the warranty.



FOR YOUR RECORDS

Write the model and serial numbers here:

You can find them in the upper right corner on the back of your washer.



READ THIS MANUAL

Inside you will find many helpful hints on how to use and maintain your washer properly. Just a little preventive care on your part can save you a great deal of time and money over the life of your washer.



IF YOU NEED SERVICE

You'll find many answers to common problems in the *Before You Call For Service* section. If you review our chart of *Troubleshooting Tips* first, you may not need to call for service at all.

If you do need service, you can relax knowing help is only a phone call away. A list of toll-free customer service numbers is included in the back section. Or you can always call the GE Answer Center[®], at 800.626.2000, 24 hours a day, 7 days a week.

IMPORTANT SAFETY INFORMATION. READ ALL INSTRUCTIONS BEFORE USING.

⚠ WARNING! For your safety, the information in this manual must be followed to minimize the risk of fire or explosion, electric shock, or to prevent property damage, personal injury, or loss of life.



WATER HEATER SAFETY

Under certain conditions hydrogen gas may be produced in a water heater that has not been used for two weeks or more. Hydrogen gas can be explosive under these circumstances.

If the hot water has not been used for two weeks or more, prevent the possibility of damage or injury by turning on all hot water faucets and allowing them to run for several minutes. Do this before using any electrical appliance which is connected to the hot water system. This simple procedure will allow any built-up hydrogen gas to escape. Since the gas is flammable, do not smoke or use an open flame or appliance during this process.



PROPER INSTALLATION

This washer must be properly installed and located in accordance with the Installation Instructions before it is used. If you did not receive an Installation Instructions sheet, you can receive one by calling, toll-free, the GE Answer Center[®], 800.626.2000.

- Install or store where it will not be exposed to temperatures below freezing or exposed to the weather.
- Properly ground washer to conform with all governing codes and ordinances. Follow details in Installation Instructions.



YOUR LAUNDRY AREA

- Keep the area underneath and around your appliances free of combustible materials such as lint, paper, rags, chemicals, etc.
- Close supervision is necessary if this appliance is used by or near children. Do not allow children to play on, with, or inside this or any other appliance.



WHEN USING THE WASHER

- Never reach into washer while it is moving. Wait until the machine has completely stopped before opening the lid.
- Do not mix chlorine bleach with ammonia or acids such as vinegar and/or rust remover. Mixing different chemicals can produce a toxic gas which may cause death.
- Do not wash or dry articles that have been cleaned in, washed in, soaked in, or spotted with combustible or explosive substances (such as wax, oil, paint, gasoline, degreasers, dry-cleaning solvents, kerosene, etc.) which may ignite or explode. Do not add these substances to the wash water. Do not use or place these substances around your washer or dryer during operation.
- The laundry process can reduce the flame retardancy of fabrics. To avoid such a result, carefully follow the garment manufacturer's wash and care instructions.
- To minimize the possibility of electric shock, unplug this appliance from the power supply or disconnect the washer at the household distribution panel by removing the fuse or switching off the circuit breaker before attempting any maintenance or cleaning. **NOTE:** Pressing PAUSE does **NOT** disconnect the appliance from the power supply.
- Never attempt to operate this appliance if it is damaged, malfunctioning, partially disassembled, or has missing or broken parts, including a damaged cord or plug.

Use this appliance only for its intended purpose as described in this Owner's Manual.



WHEN NOT IN USE

- Turn off water faucets to relieve pressure on hoses and valves and to minimize leakage if a break or rupture should occur. Check the condition of the fill hoses; they may need replacement after 5 years.
- Before discarding a washer, or removing it from service, remove the washer lid to prevent children from hiding inside.
- Do not attempt to repair or replace any part of this appliance unless specifically recommended in this Owner's Manual, or in published user-repair instructions that you understand and have the skills to carry out.
- Do not tamper with controls.



Read and follow this Safety Information carefully.

SAVE THESE INSTRUCTIONS

About the washer control panel.

You can locate your model number behind the top edge of the control panel.

Model WBSE2090

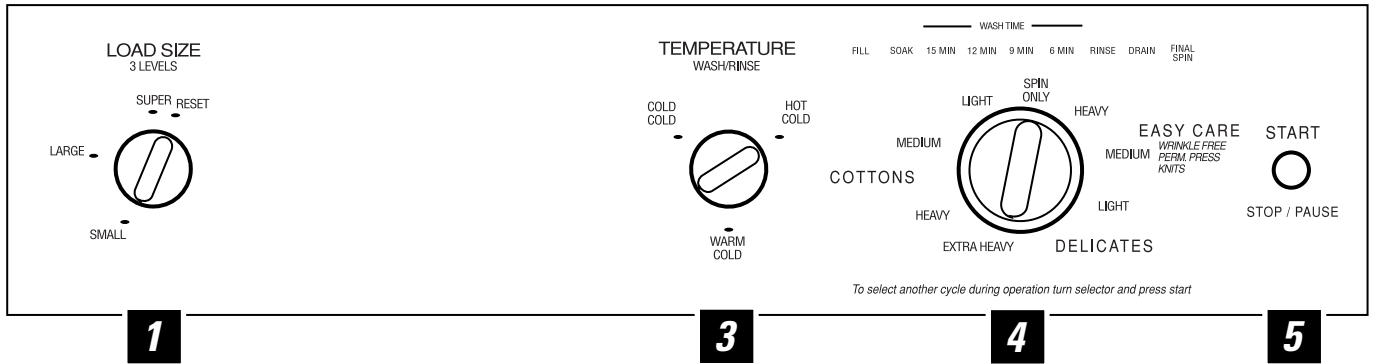

Model WBXE2070

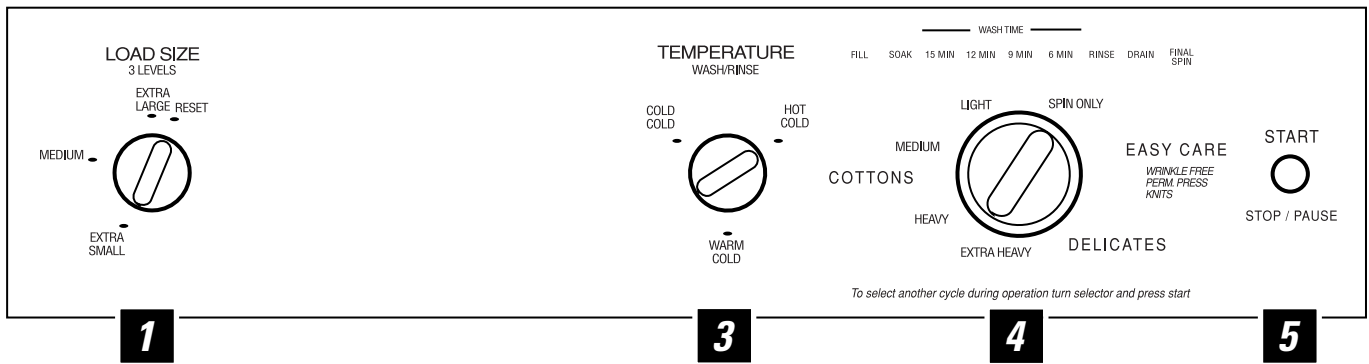

Model WCSE3100

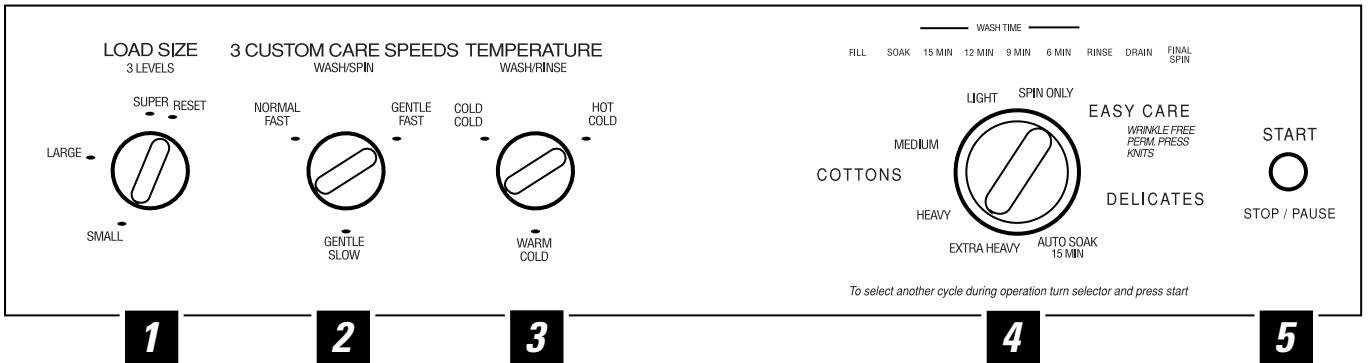

Model WCSE4230

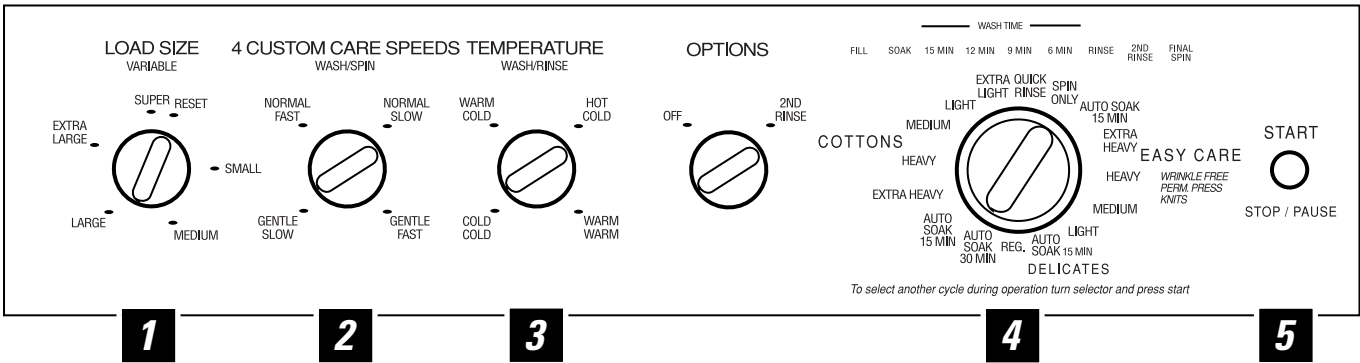

Model WJSE3110

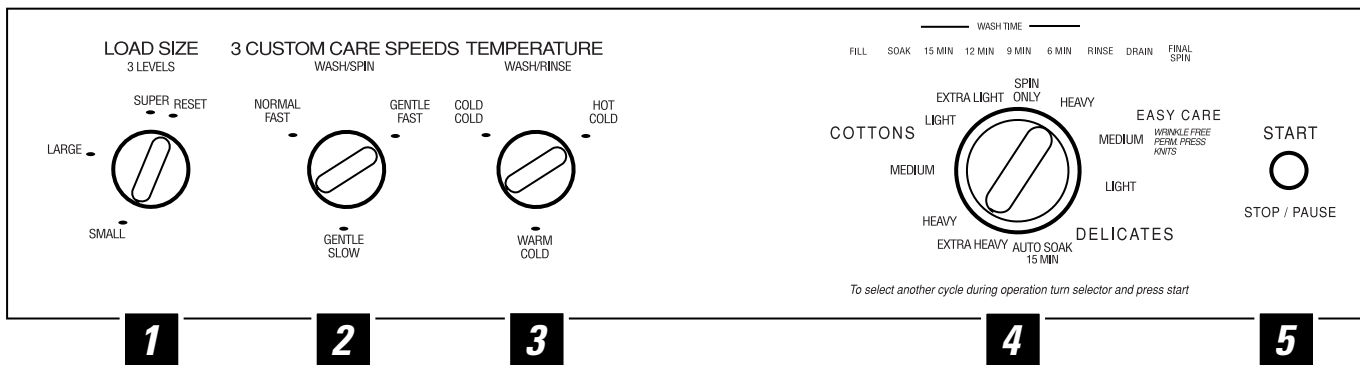

Model WWSE3160

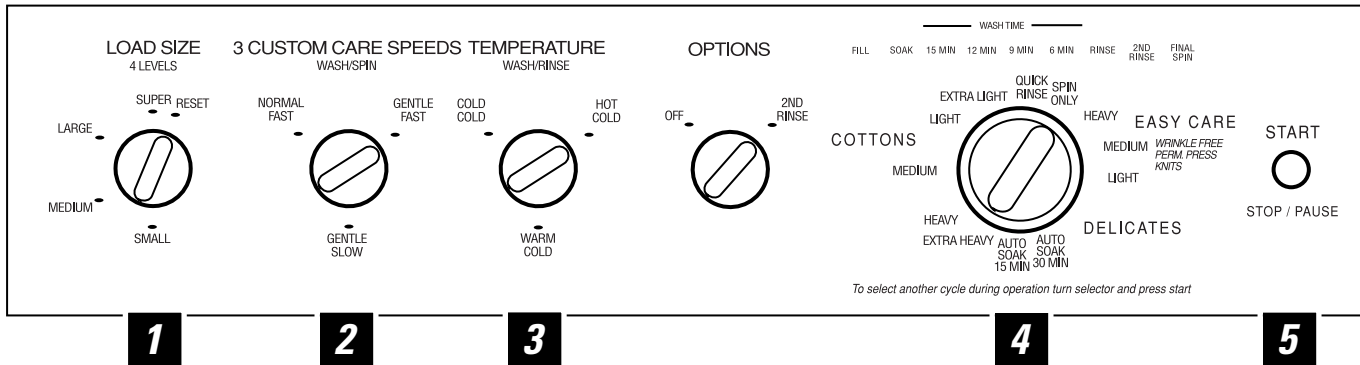

About the control settings.

1 Load Size

The water level should just cover the clothes. Adjust the load size accordingly. Loosely load clothes no higher than the top row of holes in the washer tub.

2 Custom Care Wash/Spin Speeds (on some models)

The agitator moves clothes around for a cleaner wash; the basket spins later in the cycle to release water from the load. The Wash/Spin Speed dial sets the speed of both the agitator and the basket.

With Normal wash speed, the agitator will move at a high speed for the first few minutes. It will then step down to a moderate speed. This will help to maximize soil removal while reducing the wear on your clothing. Use for cottons, denims and play clothes.

With Gentle wash speed, the agitator moves slower. Use for delicate and knit items.

The Fast spin speed is for durable items.

The Slow spin speed is for delicate items like sweaters and lingerie. When using Slow spin speed, clothes will be less dry than when using Fast spin speed.

3 Temperature

Select the water temperature for the wash and rinse cycles. Always follow fabric manufacturer's care label or instructions when laundering. Follow the water temperature guide on the washer lid.

4 Wash Cycle

The wash cycle controls the length of the washing process. When choosing the cycle, the Cycle Selector knob can be pointed anywhere within the colored box. The knob can be turned in either direction. Turning the Cycle Selector knob after starting a cycle will stop the washer and reset the cycle to the new selection. Press START to begin the new cycle selection.

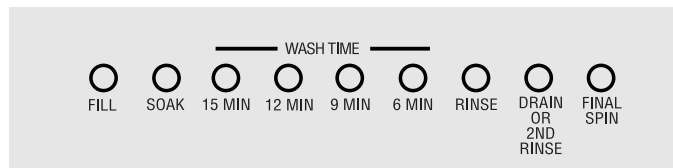

The Cycle Indicator Lights show what stage the washer is in. The wash time is the length of the wash agitation. The *6 MIN* light will remain lit during drain and spin. When the Selector knob is set to a new cycle the Indicator Lights will flash momentarily, showing what stages the cycle will go through.

The chart below will help you match the wash cycle setting with your clothing.

COTTONS For heavy to lightly soiled cottons, household linens, work and play clothes.

EASY CARE For wrinkle-free and permanent press items, and knits.

DELICATES For lingerie and special-care fabrics with light soils. Provides periods of agitation and soak during wash and rinse.

EXTRA HEAVY For heavily soiled and heavy-duty fabrics. This cycle provides a longer agitation.

15 MIN/30 MIN AUTO SOAK For heavily soiled clothes. Begins with a brief agitation, soaks for a specified period of time, then moves through the rest of the cycle automatically.

5 START

Press START to begin the cycle. Pressing START again or raising the lid will PAUSE the cycle and the Cycle indicator light will blink.

About washer features.

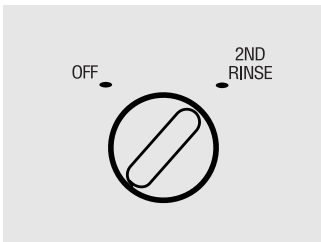

2nd Rinse Option (on some models)

When you use extra detergent or bleach to clean heavily soiled clothes, you may want to use the 2nd Rinse option. It provides a second deep cold rinse.

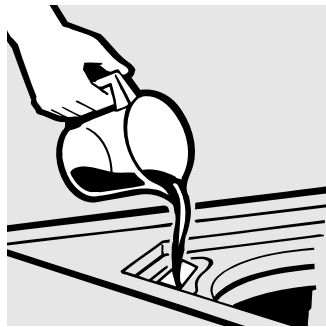

Liquid Bleach Dispenser

The dispenser dilutes liquid chlorine bleach before it reaches into your wash load.

- 1 Check clothing care labels for special instructions.
- 2 Measure liquid bleach carefully, following instructions on the bottle.
 - Never pour undiluted liquid chlorine bleach directly onto clothes or into the wash basket.
 - Do not pour powdered bleach into bleach dispenser.
- 3 Before starting the washer, pour measured amount of bleach directly into bleach dispenser. Avoid splashing or over-filling dispenser. If you prefer to use powdered bleach, add it into the wash basket with your detergent.
 - Do not mix chlorine bleach with ammonia or acids such as vinegar and/or rust remover. Mixing can produce a toxic gas which may cause death.

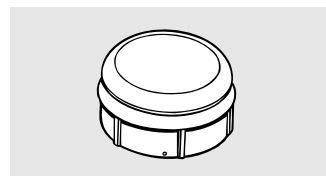

The Agitator Cap or Fabric Softener Dispenser

The agitator cap fits into the top of the agitator. If it accidentally comes off, simply put it back on.

The fabric softener dispenser automatically releases liquid fabric softener at the proper time during the cycle.

Do not stop the washer during the first spin. This will cause the dispenser to empty too soon.

To use, follow these steps:

- 1 Make sure dispenser is securely attached to agitator.
- 2 Use only liquid fabric softener.
 - Pour into dispenser, using amount recommended on package.

Never pour fabric softener directly on clothes. It may stain them.

- 3 Add water to dispenser until it reaches the maximum fill line.



Do not pour anything into the agitator if the agitator cap or dispenser is removed.

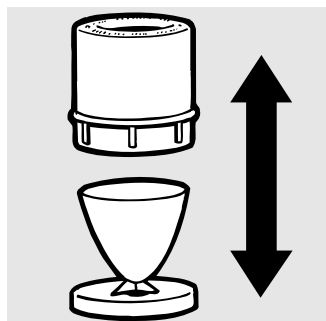

Separate for cleaning.

Cleaning the Fabric Softener Dispenser

- 1 Remove the dispenser from the top of the agitator.
- 2 Separate the dispenser cup from the cover by grasping the top and pushing down on the inside of the cup with your fingers. Dispenser cup will pop free from the cover.
- 3 To clean the dispenser, soak both the dispenser cup and the dispenser cover in the following solution:
 - 1 US gallon (3.8 liters) warm water
 - 1/4 cup (60 ml) heavy duty liquid detergent
 - 1 cup (240 ml) bleach
- 4 If necessary, loosen build-up with a clean, soft cloth after soaking. Do not use a stiff brush; you may roughen the surface of the dispenser.
- 5 Rinse and reassemble dispenser. Place dispenser back on the agitator.

Loading and using the washer. *Always follow fabric manufacturer's care label when laundering.*



Sorting Wash Loads

Colors	Soil	Fabric	Lint
Whites	Heavy	Delicates	Lint Producers
Lights	Normal	Easy Care	Lint Collectors
Darks	Light	Sturdy Cottons	

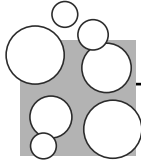

Proper Use of Detergent

Add detergent and start the washer before adding clothes so that the detergent can work effectively. Using too little or too much detergent is a common cause of laundry problems.

You can use less detergent if you have soft water, a smaller load, or a lightly soiled load.



Loading the Washer

Load dry items loosely, no higher than the top row of holes in the washer tub. When loading wet items make sure you set the load/water level high enough to allow the items to move freely. Water level should just cover the clothes. To add items after washer has started, lift the lid and submerge additional items next to the agitator.

- *Do not wrap large items like sheets around the agitator.*
- *Do not wash fabrics containing flammable materials (waxes, cleaning fluids, etc.).*
- *Agitation will not start with the lid up.*



Care and Cleaning of the Washer

Wash Basket: Leave the lid open after washing to allow moisture to evaporate. If you want to clean the basket use a clean soft cloth dampened with liquid detergent, then rinse. (Do not use harsh or gritty cleaners.)

Fill Hoses: Hoses connecting washer to faucet should be replaced every 5 years.

Lint Filter: The lint filter is located under the agitator. It is self-cleaning and requires no maintenance.

Exterior: Immediately wipe off any spills. Wipe with damp cloth. Try not to hit surface with sharp objects.

Moving and Storage: Ask the service technician to remove water from drain pump and hoses. Do not store the washer where it will be exposed to the weather. Call the GE Answer Center[®], 800.626.2000 for information on how to keep the tub stationary when moving the washer.

Long Vacations: Be sure water supply is shut off at faucets. Drain all water from hoses if weather will be below freezing.



Fabric Care Labels

Below are fabric care label “symbols” that affect the clothing you will be laundering.

WASH LABELS

Machine wash cycle						
	Normal	Permanent Press/ wrinkle resistant	Gentle/ delicate	Hand wash	Do not wash	Do not wring
Water temperature						
	Hot (50°C/120°F)		Warm (40°C/105°F)		Cold/cool (30°C/85°F)	

DRY LABELS

Tumble dry						
	Dry	Normal	Permanent Press/ wrinkle resistant	Gentle/ delicate	Do not tumble dry	Do not dry (used with do not wash)
Heat setting						
	High	Medium	Low	No heat/air		
Special instructions						
	Line dry/ hang to dry	Drip dry	Dry flat	In the shade		

BLEACH LABELS

Bleach symbols			
	Any bleach (when needed)	Only non-chlorine bleach (when needed)	Do not bleach

Before you call for service...



Troubleshooting Tips

Save time and money! Review the charts on the following pages first and you may not need to call for service.

WATER	Possible Causes	What To Do
Too many suds	Type of detergent	<ul style="list-style-type: none"> Switch to a lower sudsing detergent brand and follow instructions on package.
	Very soft water	<ul style="list-style-type: none"> Try less detergent.
	Too much detergent	<ul style="list-style-type: none"> Measure your detergent carefully. Use less soap if you have soft water, a smaller load, or a lightly soiled load.
Water leaks	Fill hoses or drain hose is improperly connected	<ul style="list-style-type: none"> Make sure hose connections are tight at faucets and make sure end of drain hose is correctly inserted in and secured to drain facility.
	Household drain may be clogged	<ul style="list-style-type: none"> Check household plumbing. You may need to call a plumber.
	Constant water pressure to the fill hoses at the water source	<ul style="list-style-type: none"> Tighten hoses at the faucets and turn the water off after each use. Check condition of the fill hoses; they may need replacement after 5 years.
	Using too much detergent in washer	<ul style="list-style-type: none"> Use less detergent. Use less soap if you have soft water, a smaller load, or a lightly soiled load.
Water temperature is incorrect	Control is not set properly	<ul style="list-style-type: none"> Check water temperature control and adjust.
	Water supply is turned off or improperly connected	<ul style="list-style-type: none"> Turn both hot and cold faucets fully on and make sure hoses are connected to correct faucets.
	Water valve screens are stopped up	<ul style="list-style-type: none"> Turn off the water source and remove the water connection hoses from the upper back of the washer. Use a brush or toothpick to clean the screens in the machine. Reconnect the hoses and turn the water back on.
	House water heater is not set properly	<ul style="list-style-type: none"> Make sure house water heater is delivering water at 120°F.-140°F. (48°C.-60°C.).
Water pumped out before cycle is complete	Lid lifted or cycle was put in pause for over 24 hours	<ul style="list-style-type: none"> Reset cycle.
Water won't drain	Drain hose is kinked or improperly connected	<ul style="list-style-type: none"> Straighten drain hose and make sure washer is not sitting on it.
		<ul style="list-style-type: none"> Top of drain outlet should be less than 8 ft (2.5 m) above floor.
OPERATION	Possible Causes	What To Do
Washer pauses in cycle	The DELICATES cycle was chosen	<ul style="list-style-type: none"> This is normal. The DELICATES cycle has a short soak period.

(con) OPERATION	Possible Causes	What To Do
Wash speed changes	A Normal wash speed was chosen	<ul style="list-style-type: none"> It is normal for the Normal wash speed to change from fast to moderate during the wash cycle.
Washer won't operate	Washer is unplugged	<ul style="list-style-type: none"> Make sure cord is plugged securely into a working outlet.
	Water supply is turned off	<ul style="list-style-type: none"> Turn both hot and cold faucets fully on.
	Controls are not set properly	<ul style="list-style-type: none"> Check controls.
	Lid is open	<ul style="list-style-type: none"> Close lid.
	Circuit breaker/fuse is tripped/blown	<ul style="list-style-type: none"> Check house circuit breakers/fuses. Replace fuses or reset breaker. Washer should have separate outlet.
	Electronics need to be reset	<ul style="list-style-type: none"> Unplug washer, wait 2 minutes, plug back in, and press START.
	START was not pressed	<ul style="list-style-type: none"> Press START.

PERFORMANCE	Possible Causes	What To Do	
Clothes too wet	Incorrect spin cycle selected	<ul style="list-style-type: none"> Make sure the spin cycle selected matches the load you are washing. Some fabrics will feel wetter when rinsed with cold water. 	
Colored spots	Incorrect use of fabric softener	<ul style="list-style-type: none"> Check fabric softener package for instructions and follow directions for using dispenser. Pretreat stain and rewash. 	
	Dye transfer	<ul style="list-style-type: none"> Sort whites or lightly colored items from dark colors. 	
Grayed or yellowed clothes	Not enough detergent	<ul style="list-style-type: none"> Use more detergent (especially with larger loads). 	
	Hard water	<ul style="list-style-type: none"> Use a water conditioner like Calgon brand or install a water softener. 	
	Water is not hot enough	<ul style="list-style-type: none"> Make sure water heater is delivering water at 120°F.–140°F. (48°C.–60°C.). 	
	Washer is overloaded	<ul style="list-style-type: none"> Select load size to match clothes load. 	
	Detergent is not dissolving	<ul style="list-style-type: none"> Add detergent as wash basket fills with water before you load clothes. 	
	Dye transfer	<ul style="list-style-type: none"> Sort clothes by color. If fabric label states <i>wash separately</i>, unstable dyes may be indicated. 	
Lint or residue on clothes	Clothes are air or line dried	<ul style="list-style-type: none"> If you do not dry your clothes with a clothes dryer, your clothes may retain more lint. 	
	Incorrect sorting	<ul style="list-style-type: none"> Separate lint producers from lint collectors. 	
	Washing too long	<ul style="list-style-type: none"> Wash small loads for a shorter time than larger loads. 	
	Detergent not dissolving		<ul style="list-style-type: none"> Add detergent as wash basket fills with water, before you load clothes. Try a liquid detergent. Use warmer water temperature.
		Overloading	<ul style="list-style-type: none"> Load clothes no higher than the top row of holes in the washer tub. Make sure load size selector matches clothes load size.
		Incorrect use of fabric softener	<ul style="list-style-type: none"> Check fabric softener package for instructions and follow directions for using dispenser.

Before you call for service (cont.)...

<i>(con)</i> PERFORMANCE	Possible Causes	What To Do
Pilling	Result of normal wear on poly-cotton blends and fuzzy fabrics	<ul style="list-style-type: none"> While this is not caused by the washer, you can slow the pilling process by washing garments inside out.
Snags, holes, tears, rips or excessive wear	Pins, snaps, hooks, sharp buttons, belt buckles, zippers, and sharp objects left in pockets	<ul style="list-style-type: none"> Fasten snaps, hooks, buttons, and zippers. Remove loose items like pins, objects in pockets and sharp buttons. Turn knits (which snag easily) inside out.
	Undiluted chlorine bleach	<ul style="list-style-type: none"> Check bleach package instructions for proper amount. Never add undiluted bleach to wash or allow clothes to come in contact with undiluted bleach.
	Chemicals like hair bleach or dye, permanent wave solution	<ul style="list-style-type: none"> Rinse items that may have chemicals on them before washing.
Wrinkling	Improper sorting	<ul style="list-style-type: none"> Avoid mixing heavy items (like work clothes) with light items (like blouses). Try a fabric softener.
	Overloading or incorrect water level	<ul style="list-style-type: none"> Load your washer so clothes have enough room to move freely.
	Incorrect wash and dry cycles	<ul style="list-style-type: none"> Match Cycle selection to the type of fabric you are washing (especially for easy care loads).
	Repeated washing in water that is too hot	<ul style="list-style-type: none"> Wash in warm or cold water.
NOISE	Possible Causes	What To Do
Washer is noisy	Washer is uneven	<ul style="list-style-type: none"> To level the front of the washer, adjust the front leveling legs by rotating the individual leg in the proper direction for up or down. To level back of washer, lift back of machine 4" (11 cm) and set down.
	Washer load is unbalanced	<ul style="list-style-type: none"> Press PAUSE to stop the washer, open the lid and redistribute the load evenly. Close the lid and press START.
	Shipping rod is still assembled in unit	<ul style="list-style-type: none"> To remove shipping rod from washer, pull yellow tag and attached rod from the bottom right hand side of washer.
	Washer is sitting too close to wall (causes knocking during cycle)	<ul style="list-style-type: none"> Pull washer away from the wall; about 4" (11 cm) is needed.
OTHER	Possible Causes	What To Do
Labels on the exterior of the washer will not peel off cleanly	Occasionally the adhesive used on the labels does not release cleanly	<ul style="list-style-type: none"> Use a hair dryer set at the lowest heat setting, directing the air at the label for a short amount of time. This will release the adhesive easily, without damaging the surface of the washer.

GE Service Protection Plus™

GE, a name recognized worldwide for quality and dependability, offers you Service Protection Plus™—comprehensive protection on all your appliances—**No Matter What Brand!**

Benefits Include:

- Backed by GE
- All brands covered
- Unlimited service calls
- All parts and labor costs included
- No out-of-pocket expenses
- No hidden deductibles
- One 800 number to call

***We'll Cover Any Appliance.
Anywhere. Anytime.****

You will be completely satisfied with our service protection or you may request your money back on the remaining value of your contract. No questions asked. It's that simple.

Protect your refrigerator, dishwasher, washer and dryer, range, TV, VCR and much more—**any brand!** Plus there's no extra charge for emergency service and low monthly financing is available. Even icemaker coverage and food spoilage protection is offered. You can rest easy, knowing that all your valuable household products are protected against expensive repairs.

Place your confidence in GE and call us in the U.S. toll-free at **800-626-2224** for more information.

*All brands covered, up to 20 years old, in the continental U.S.

 Cut here

Please place in envelope and mail to:

General Electric Company
Warranty Registration Department
P.O. Box 32150
Louisville, KY 40232-2150

Consumer Product Ownership Registration

Dear Customer:

Thank you for purchasing our product and thank you for placing your confidence in us.

We are proud to have you as a customer!

Follow these three steps to protect your new appliance investment:

1

Complete and mail your Consumer Product Ownership Registration today. Have the peace of mind of knowing we can contact you in the unlikely event of a safety modification.

2

After mailing the registration below, store this document in a safe place. It contains information you will need should you require service. Our service number is 800 GE CARES (800-432-2737).

3

Read your Owner's Manual carefully. It will help you operate your new appliance properly. If you have questions, or need more information, call the GE Answer Center® 800.626.2000.

Model Number

Serial Number

Important: If you did not get a registration card with your product, detach and return the form below to ensure that your product is registered, or register online at www.geappliances.com.



Consumer Product Ownership Registration



Model Number

Serial Number

Mr. Ms. Mrs. Miss

First Name

Last Name

Street Address

Apt. #

E-mail Address

City

State

Zip Code

Date Placed In Use
Month

Day

Year

Phone Number

-

-

Occasionally, we may allow selected companies to send you information.
 Check here if you do not want this information.



GE Appliances

General Electric Company
Louisville, Kentucky
www.geappliances.com

GE Washer Warranty



All warranty service provided by our Factory Service Centers or an authorized Customer Care® technician. For service, call 1-800-GE-CARES.

For The Period Of:	We Will Replace:
One Year From the date of the original purchase	Any part of the washer which fails due to a defect in materials or workmanship. During this full one-year warranty , we will also provide, free of charge , all labor and in-home service to replace the defective part.
Five Years From the date of the original purchase	The transmission, suspension rod, spring assembly, washer lid and cover , if any of these parts should fail due to a defect in materials or workmanship. During this additional four-year limited warranty , you will be responsible for any labor or in-home service costs.
Ten Years From the date of the original purchase	The washer tub , if it should fail due to a defect in materials or workmanship. During this additional nine-year limited warranty , you will be responsible for any labor or in-home service costs.
Twenty Years From the date of the original purchase	The washer basket , if it should fail due to a defect in materials or workmanship. During this additional nineteen-year limited warranty , you will be responsible for any labor or in-home service costs.

What Is Not Covered:

- Service trips to your home to teach you how to use the product.
- Improper installation.
- Failure of the product if it is abused, misused, or used for other than the intended purpose or used commercially.
- Replacement of house fuses or resetting of circuit breakers.
- Damage to the product caused by accident, fire, floods or acts of God.
- Incidental or consequential damage to personal property caused by possible defects with this appliance.

This warranty is extended to the original purchaser and any succeeding owner for products purchased for home use within the USA. In Alaska, the warranty excludes the cost of shipping or service calls to your home.

Some states do not allow the exclusion or limitation of incidental or consequential damages. This warranty gives you specific legal rights, and you may also have other rights which vary from state to state. To know what your legal rights are, consult your local or state consumer affairs office or your state's Attorney General.

Warrantor: General Electric Company, Louisville, KY 40225

Service Telephone Numbers.



GE Answer Center® 800-626-2000

The GE Answer Center® is open 24 hours a day, 7 days a week.



In-Home Repair Service 800-432-2737

Expert GE repair service is only a phone call away.



Special Needs Service 800-626-2000

GE offers, free of charge, a brochure to assist in planning a barrier-free kitchen for persons with limited mobility. **Call 800-TDD-GEAC (800-833-4322).**



Service Contracts 800-626-2224

Purchase a GE service contract while your warranty is still in effect and you'll receive a substantial discount. GE Consumer Service will still be there after your warranty expires.

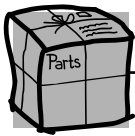

Parts and Accessories 800-626-2002

Individuals qualified to service their own appliances can have parts or accessories sent directly to their homes (VISA, MasterCard and Discover cards are accepted).

Instructions contained in this manual cover procedures to be performed by any user. Other servicing generally should be referred to qualified service personnel. Caution must be exercised, since improper servicing may cause unsafe operation.



Service Satisfaction

If you are not satisfied with the service you receive from GE:

First, contact the people who serviced your appliance.

Next, if you are still not pleased, write all the details—including your phone number—to: Manager, Customer Relations, GE Appliances, Appliance Park, Louisville, KY 40225.