

This Owner's Manual is provided and hosted by [Appliance Factory Parts](#).

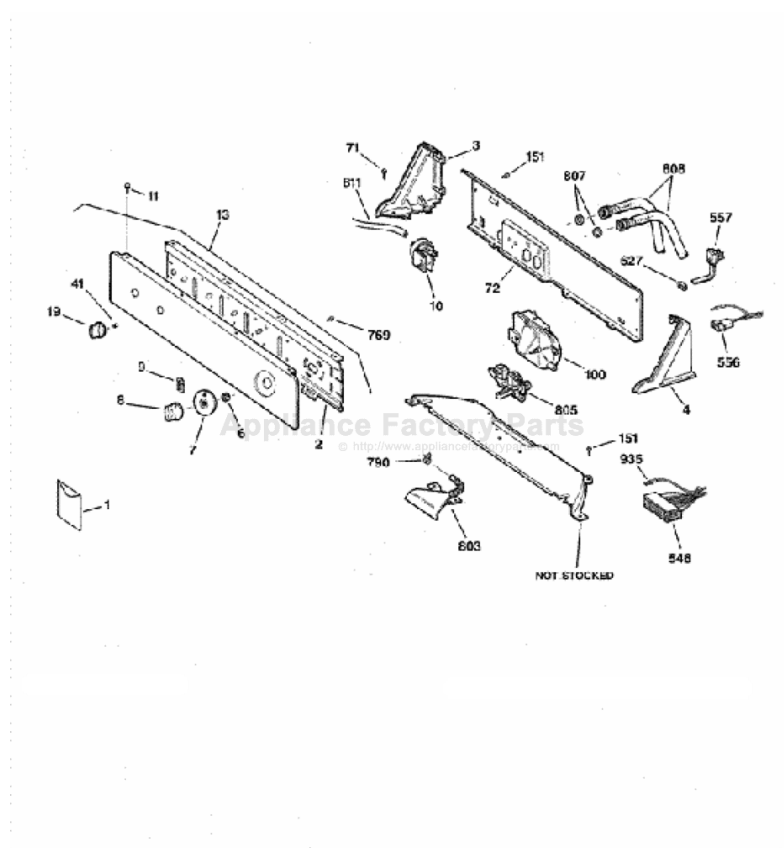

# GE WCSR2080B4CC Owner's Manual

[Shop genuine replacement parts for GE  
WCSR2080B4CC](#)



[Find Your GE Washer Parts - Select From 4591 Models](#)

----- Manual continues below -----



# Washers

*Safety Information* ..... 2, 3

***Operating Instructions***

Control Panels  
and Settings ..... 4-7  
Features ..... 8  
Loading and Using  
the Washer ..... 9, 10

***Troubleshooting Tips***

Before You Call  
For Service ..... 11-13

***Consumer Support***

Consumer Support . . . Back Cover  
Warranty ..... 15

**Owner's Manual**

WJSR2070  
WCSR2080  
WVSR1060  
WBXR2090  
WBXR3100  
S3500

**Write the model and serial numbers here:**

**Model #** \_\_\_\_\_

**Serial #** \_\_\_\_\_

You can find them in the upper right corner on the back of your washer.



# IMPORTANT SAFETY INFORMATION. READ ALL INSTRUCTIONS BEFORE USING.

**⚠ WARNING!** For your safety, the information in this manual must be followed to minimize the risk of fire or explosion, electric shock, or to prevent property damage, personal injury, or loss of life.



## WATER HEATER SAFETY

*Under certain conditions hydrogen gas may be produced in a water heater that has not been used for two weeks or more. Hydrogen gas can be explosive under these circumstances.*

If the hot water has not been used for two weeks or more, prevent the possibility of damage or injury by turning on all hot water faucets and allowing them to run for several minutes. Do this before using any electrical appliance which is connected to the hot water system. This simple procedure will allow any built-up hydrogen gas to escape. Since the gas is flammable, do not smoke or use an open flame or appliance during this process.

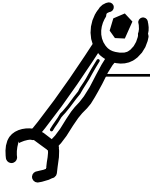

## PROPER INSTALLATION

*This washer must be properly installed and located in accordance with the Installation Instructions before it is used. If you did not receive an Installation Instructions sheet, you can receive one by visiting [www.GEAppliances.com](http://www.GEAppliances.com), or by calling **800.GE.CARES (800.432.2737)**.*

- Install or store where it will not be exposed to temperatures below freezing or exposed to the weather.
- Properly ground washer to conform with all governing codes and ordinances. Follow details in Installation Instructions.



## YOUR LAUNDRY AREA

- Keep the area underneath and around your appliances free of combustible materials such as lint, paper, rags, chemicals, etc.
- Close supervision is necessary if this appliance is used by or near children. Do not allow children to play on, with or inside this or any other appliance.



Use this appliance only for its intended purpose as described in this Owner's Manual.

## WHEN USING THE WASHER

- Never reach into washer while it is moving. Wait until the machine has completely stopped before opening the lid.
- Do not mix chlorine bleach with ammonia or acids such as vinegar and/or rust remover. Mixing different chemicals can produce a toxic gas which may cause death.
- Do not wash or dry articles that have been cleaned in, washed in, soaked in or spotted with combustible or explosive substances (such as wax, oil, paint, gasoline, degreasers, dry-cleaning solvents, kerosene, etc.) which may ignite or explode. Do not add these substances to the wash water. Do not use or place these substances around your washer or dryer during operation.
- The laundry process can reduce the flame retardancy of fabrics. To avoid such a result, carefully follow the garment manufacturer's wash and care instructions.
- To minimize the possibility of electric shock, unplug this appliance from the power supply or disconnect the washer at the household distribution panel by removing the fuse or switching off the circuit breaker before attempting any maintenance or cleaning. **NOTE:** Turning the Cycle Selector knob to an off position does **NOT** disconnect the appliance from the power supply.
- Never attempt to operate this appliance if it is damaged, malfunctioning, partially disassembled, or has missing or broken parts, including a damaged cord or plug.



## WHEN NOT IN USE

- Turn off water faucets to relieve pressure on hoses and valves and to minimize leakage if a break or rupture should occur. Check the condition of the fill hoses; they should be replaced every 5 years.
- Before discarding a washer, or removing it from service, remove the washer lid to prevent children from hiding inside.
- Do not attempt to repair or replace any part of this appliance unless specifically recommended in this Owner's Manual, or in published user-repair instructions that you understand and have the skills to carry out.
- Do not tamper with controls.



**READ AND FOLLOW THIS SAFETY INFORMATION CAREFULLY.  
SAVE THESE INSTRUCTIONS**

# About the washer control panel.

(models WJSR2070, WCSR2080, WBXR3100 and S3500)

You can locate your model number on the back of your washer.

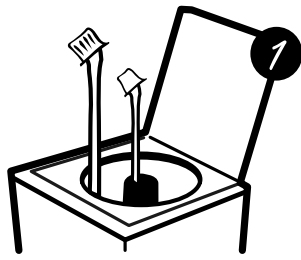

- Add detergent
- Add diluted fabric softener (on models with a fabric softener dispenser)

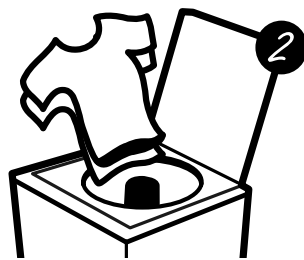

- Add clothes

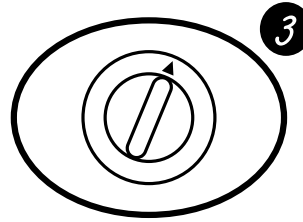

- Select load size and other wash options
- Select wash cycle

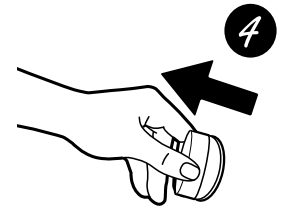

- Close lid
- Pull knob

## Quick Start Guide

### Model WJSR2070

**LOAD SIZE**

**TEMPERATURE WASH/RINSE**

Pull Knob To Start - Push To Stop

### Model WCSR2080

**LOAD SIZE**

**TEMPERATURE WASH/RINSE**

Pull Knob To Start - Push To Stop

### Model WBXR3100

**LOAD SIZE**

**TEMPERATURE WASH/RINSE**

Pull Knob To Start - Push To Stop

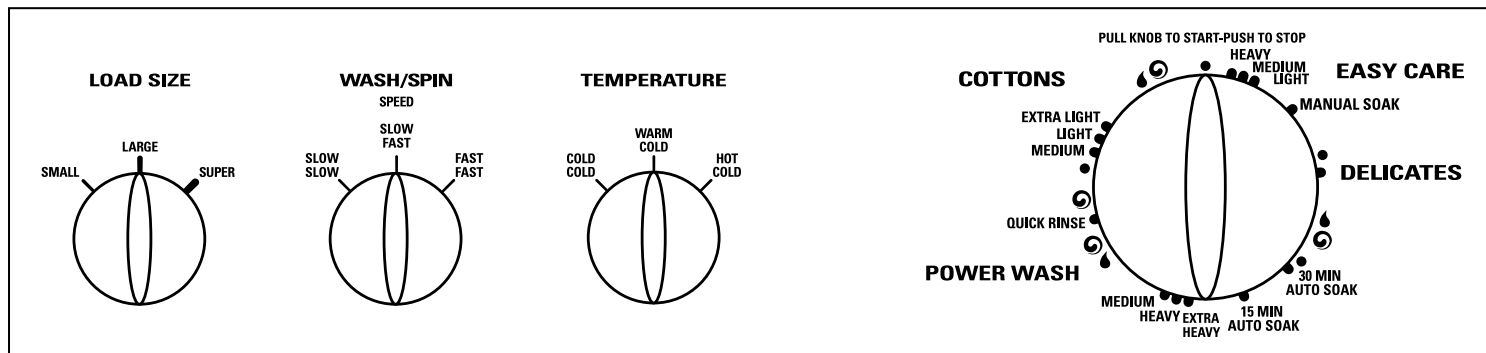
**Model S3500****Control settings.****Load Size**

Loosely load clothes no higher than the top row of holes in the washer tub. The water level should just cover the clothes. Adjust the load size accordingly.

**Wash/Spin Speed (on some models)**

The agitator moves clothes around for a cleaner wash; the basket spins later in the cycle to release water from the load. The Wash/Spin Speed dial sets the speed of both the agitator and the basket.

**Wash Speeds**

Use **Fast wash speed** for cottons, denims and play clothes.

Use **Slow wash speed** for delicate and knit items.

**Spin Speeds**

The **Fast spin speed** is for durable items.

The **Slow spin speed** is for delicate items like sweaters and lingerie. Clothes will be less dry than when using the **Fast spin speed**.

**Temperature**

Select the water temperature for the wash and rinse cycles. Always follow fabric manufacturer's care label or instructions when laundering.

**Wash Cycle**

The wash cycle controls the length of the washing process. The chart below will help you match the wash cycle setting with your clothing.

**COTTONS/ WHITES** For heavy to lightly soiled cottons, household linens, work and play clothes.

**EASY CARE** For wrinkle-free and permanent press items, and knits.

**CASUALS** A gentler way to clean clothes.

**PULSE AGITATE** **This cycle agitates and then pauses to soak your clothes, simulating hand washing.**

**GENTLE** The **HEAVY** cycle has three agitate/pause cycles to clean your heavily soiled items.

The **MEDIUM** cycle has two agitate/pause cycles, and the **LIGHT** cycle has one agitate/pause cycle.

The washer will fill with water to the chosen level when the washer is started in any part of the **CASUALS** cycle. **If the washer is started in the pause/soak portion of the cycle, then the washer will complete this soak before it begins to agitate. This is normal.**

**DELICATES** For lingerie and special-care fabrics with light to normal soil.

**POWER WASH** For heavily soiled and heavy-duty fabrics. This cycle provides a longer agitation.

# About the washer control panel.

(models WVSR1060 and WBXR2090)

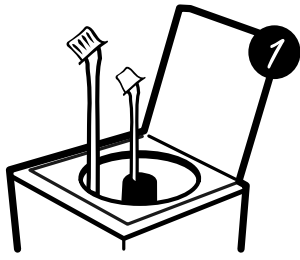

- Add detergent
- Add diluted fabric softener (on models with a fabric softener dispenser)

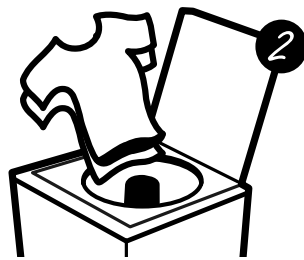

- Add clothes

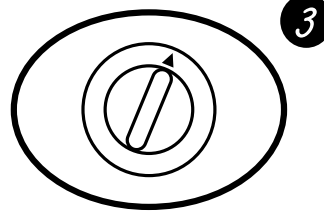

- Select load size and other wash options
- Select wash cycle

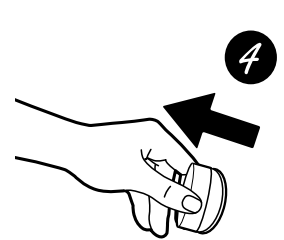

- Close lid
- Pull knob

## Quick Start Guide

### Model WVSR1060

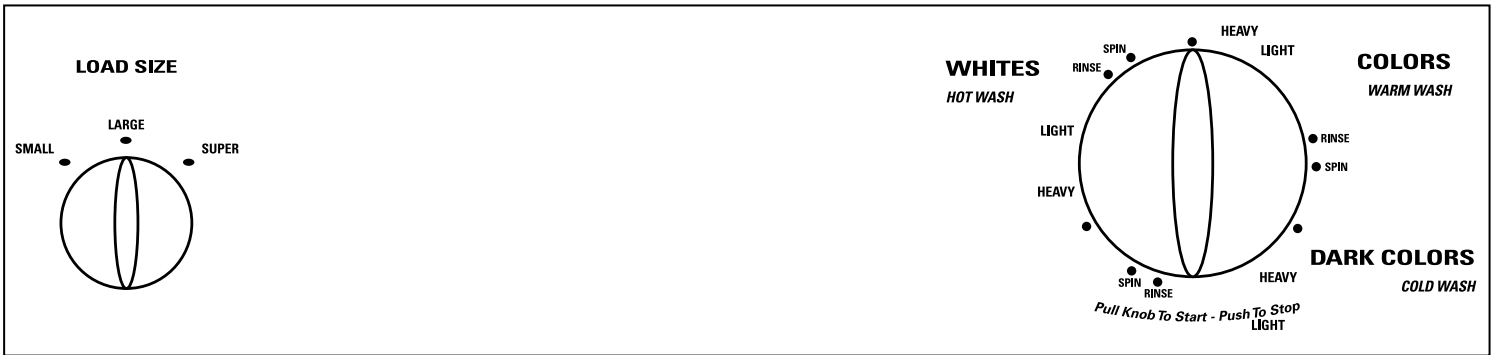

### Model WBXR2090

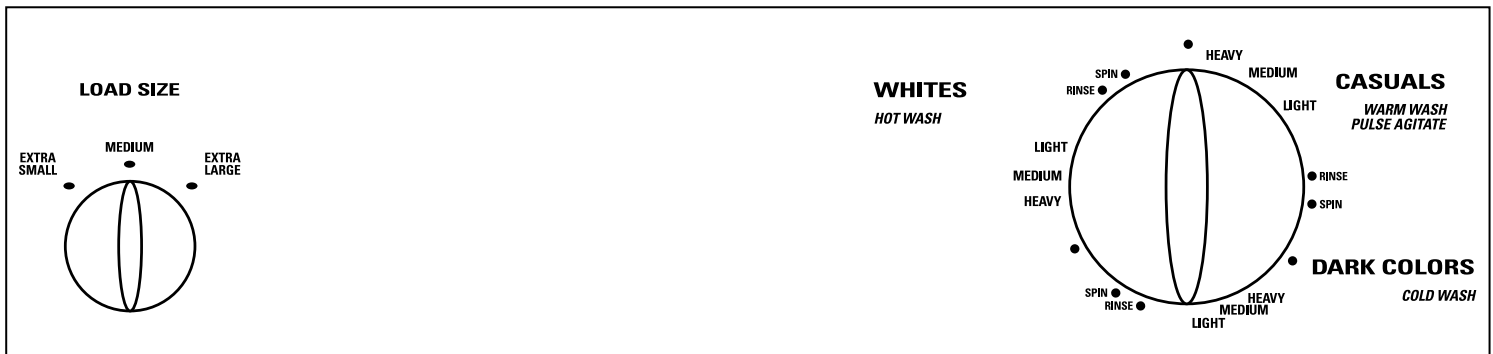



## Load Size

Loosely load clothes no higher than the top row of holes in the washer tub. The water level should just cover the clothes. Adjust the load size accordingly.



## Wash Cycle

The wash cycle controls the length of the washing process and the wash temperature. You can choose a cooler wash temperature no matter what color of fabric you are washing. Always follow the instructions on the fabric care label when laundering. The chart below will help you match the wash cycle setting with your clothing.

**WHITES  
HOT WASH** For heavy to lightly soiled cottons, household linens, work and play clothes.

---

**COLORS  
WARM WASH** For wrinkle-free and permanent press items, knits and cottons.

---

**CASUALS** For wrinkle-free and permanent press items, and knits.

**WARM WASH** **This cycle agitates and then pauses to soak your clothes, simulating hand washing.**

**PULSE AGITATE** The **HEAVY** cycle has three agitate/pause cycles to clean your heavily soiled items.

The **MEDIUM** cycle has two agitate/pause cycles, and the **LIGHT** cycle has one agitate/pause cycle.

The washer will fill with water to the chosen level when the washer is started in any part of the **CASUALS** cycle.

**If the washer is started in the pause/soak portion of the cycle, then the washer will complete this soak before it begins to agitate. This is normal.**

---

**DARK COLORS  
COLD WASH** For non-colorfast cottons and blends and items that are labeled cold wash by the fabric manufacturer.

---

## About the washer features.

NOTE: Not all features are available on all washer models.

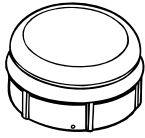

### The Agitator Cap or Fabric Softener Dispenser (depending on model)

The **agitator cap** fits into the top of the agitator. If it accidentally comes off, simply put it back on.

The **fabric softener dispenser** automatically releases liquid fabric softener at the proper time during the cycle.

*Do not stop the washer during the first spin. This will cause the dispenser to empty too soon.*

To use, follow these steps:

- 1 Make sure dispenser is securely attached to agitator.
- 2 Use only liquid fabric softener. Pour into dispenser, using amount recommended on package.

*Never pour fabric softener directly on clothes. It may stain them.*

- 3 Add water to dispenser until it reaches the maximum fill line.

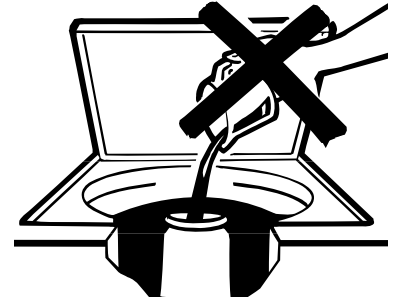

*Do not pour anything into the agitator if the agitator cap or dispenser is removed.*



Separate for cleaning.

### Cleaning the Fabric Softener Dispenser (on some models)

- 1 Remove the dispenser from the top of the agitator.
- 2 Separate the dispenser cup from the cover by grasping the top and pushing down on the inside of the cup with your fingers. Dispenser cup will pop free from the cover.
- 3 To clean the dispenser, soak both the dispenser cup and the dispenser cover in the following solution:
  - 1 US gallon (3.8 liters) warm water
  - 1/4 cup (60 ml) heavy duty liquid detergent
  - 1 cup (240 ml) bleach
- 4 If necessary, loosen buildup with a clean, soft cloth after soaking. Do not use a stiff brush; you may roughen the surface of the dispenser.
- 5 Rinse and reassemble dispenser. Place dispenser back on the agitator.

### Liquid Bleach Dispenser (on some models)

The dispenser dilutes liquid chlorine bleach before it reaches your wash load.

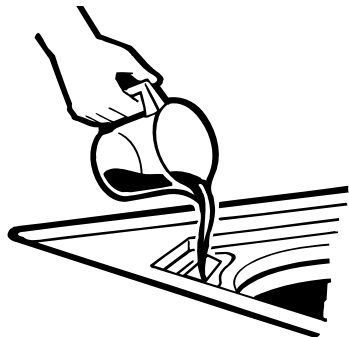

- 1 Check clothing care labels for special instructions.
- 2 Measure liquid bleach carefully, following instructions on the bottle.
  - Never pour undiluted liquid chlorine bleach directly onto clothes or into the wash basket.
  - Do not pour powdered bleach into bleach dispenser.
- 3 Before starting the washer, pour measured amount of bleach directly into bleach dispenser. Avoid splashing or over-filling dispenser. If you prefer to use powdered bleach, add it into the wash basket with your detergent.
  - Do not mix chlorine bleach with ammonia or acids such as vinegar and/or rust remover. Mixing can produce a toxic gas which may cause death.

# Loading and using the washer.

Always follow fabric manufacturer's care label when laundering.

[www.GEAppliances.com](http://www.GEAppliances.com)



## Sorting Wash Loads

Sort by color (whites, lights, colors), soil level, fabric type (sturdy cottons, easy care, delicates), and whether the fabric produces lint (terry cloth, chenille), or collects lint (velveteen, corduroy).

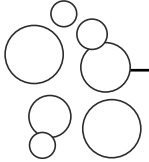

## Proper Use of Detergent

Add detergent and start the washer before adding clothes so that the detergent can work effectively. Using too little or too much detergent is a common cause of laundry problems.

You can use less detergent if you have soft water, a smaller load or a lightly soiled load.



## Loading the Washer

Load dry items loosely, no higher than the top row of holes in the washer basket. When loading wet items make sure you set the load/water level high enough to allow the items to move freely. Water level should just cover the clothes. To add items after washer has started, push in Cycle knob and submerge additional items next to the agitator. Close the lid and pull Cycle knob out to restart.

- Do not wrap long items like sheets or pants around the agitator.
- Do not wash fabrics containing flammable materials (waxes, cleaning fluids, etc.).
- Agitation will not start with the lid up.

**Loading and using the washer.** Always follow fabric manufacturer's care label when laundering.



**Care and Cleaning of the Washer**

**Wash Basket:** Leave the lid open after washing to allow moisture to evaporate. If you want to clean the basket, use a clean soft cloth dampened with liquid detergent, then rinse. (Do not use harsh or gritty cleaners.)

**Fill Hoses:** Hoses connecting washer to faucet should be replaced every 5 years.

**Exterior:** Immediately wipe off any spills. Wipe with damp cloth. Try not to hit surface with sharp objects.

**Moving and Storage:** Ask the service technician to remove water from drain pump and hoses. See the Installation Instructions packed with product for information on how to reinstall the shipping rod to keep the tub stationary when moving the washer. For more information, visit [www.GEAppliances.com](http://www.GEAppliances.com), or call **800.GE.CARES** (800.432.2737). Do not store the washer where it will be exposed to the weather.

**Long Vacations:** Be sure water supply is shut off at faucets. Drain all water from hoses if weather will be below freezing.



**Fabric Care Labels**

Below are fabric care label "symbols" that affect the clothing you will be laundering.

**WASH LABELS**

<b>Machine wash cycle</b>						
	Normal	Permanent Press/ wrinkle resistant	Gentle/ delicate	Hand wash	Do not wash	Do not wring
<b>Water temperature</b>						
	Hot (50°C/120°F)		Warm (40°C/105°F)		Cold/cool (30°C/85°F)	

**DRY LABELS**

<b>Tumble dry</b>						
	Dry	Normal	Permanent Press/ wrinkle resistant	Gentle/ delicate	Do not tumble dry	Do not dry (used with do not wash)
<b>Heat setting</b>						
	High	Medium	Low	No heat/air		
<b>Special instructions</b>						
	Line dry/ hang to dry	Drip dry	Dry flat	In the shade		

**BLEACH LABELS**

<b>Bleach symbols</b>			
	Any bleach (when needed)	Only non-chlorine bleach (when needed)	Do not bleach



**Troubleshooting Tips**  
 Save time and money! Review the charts on the following pages, or visit [www.GEAppliances.com](http://www.GEAppliances.com). You may not need to call for service.

<b>WATER</b>	<b>Possible Causes</b>	<b>What To Do</b>
<b>Too many suds</b>	Type of detergent	<ul style="list-style-type: none"> <li>• Switch to a lower sudsing detergent brand and follow instructions on package.</li> </ul>
	Very soft water	<ul style="list-style-type: none"> <li>• Try less detergent.</li> </ul>
	Too much detergent	<ul style="list-style-type: none"> <li>• Measure your detergent carefully. Use less soap if you have soft water, a smaller load or a lightly soiled load.</li> </ul>
<b>Water leaks</b>	Fill hoses or drain hose is improperly connected	<ul style="list-style-type: none"> <li>• Make sure hose connections are tight at faucets and rubber washers are installed. Make sure end of drain hose is correctly inserted in and secured to drain facility.</li> </ul>
	Household drain may be clogged	<ul style="list-style-type: none"> <li>• Check household plumbing. You may need to call a plumber.</li> </ul>
	Constant water pressure to the fill hoses at the water source	<ul style="list-style-type: none"> <li>• Tighten hoses at the faucets and turn the water off after each use.</li> <li>• Check condition of the fill hoses; they should be replaced every 5 years.</li> </ul>
	Using too much detergent in washer	<ul style="list-style-type: none"> <li>• Use less detergent. Use less soap if you have soft water, a smaller load or a lightly soiled load.</li> </ul>
<b>Water temperature is incorrect</b>	Control is not set properly	<ul style="list-style-type: none"> <li>• Check water temperature control (on some models) or Cycle knob and adjust.</li> </ul>
	Water supply is turned off or improperly connected	<ul style="list-style-type: none"> <li>• Turn both hot and cold faucets fully on and make sure hoses are connected to correct faucets.</li> </ul>
	Water valve screens are stopped up	<ul style="list-style-type: none"> <li>• Turn off the water source and remove the water connection hoses from the upper back of the washer. Use a brush or toothpick to clean the screens in the machine. Reconnect the hoses and turn the water back on.</li> </ul>
	House water heater is not set properly	<ul style="list-style-type: none"> <li>• Make sure house water heater is delivering water at 120°F–140°F (48°C–60°C).</li> </ul>
<b>Water won't drain</b>	Drain hose is kinked or improperly connected	<ul style="list-style-type: none"> <li>• Straighten drain hose and make sure washer is not sitting on it.</li> <li>• Top of drain outlet should be less than 8 ft. above floor.</li> </ul>

## Before you call for service...

OPERATION	Possible Causes	What To Do
<b>Washer pauses in cycle</b>	The washer normally pauses between washing steps and during the CASUALS wash cycle.	
<b>Washer won't operate</b>	Washer is unplugged	• Make sure cord is plugged securely into a working outlet.
	Water supply is turned off	• Turn both hot and cold faucets fully on.
	Controls are not set properly	• Check controls and make sure Cycle knob is pulled out to <b>ON</b> position.
	Lid is open—safety feature prevents agitation and spinning when lid is up	• Close lid and reset cycle, to the beginning if necessary.
	Circuit breaker/fuse is tripped/blown	• Check house circuit breakers/fuses. Replace fuses or reset breaker. Washer should have separate outlet.

PERFORMANCE	Possible Causes	What To Do
<b>Colored spots</b>	Incorrect use of fabric softener	• Check fabric softener package for instructions and follow directions for using dispenser. • Pretreat stain and rewash.
	Dye transfer	• Sort whites or lightly colored items from dark colors.
<b>Grayed or yellowed clothes</b>	Not enough detergent	• Use more detergent (especially with larger loads).
	Hard water	• Use a water conditioner like Calgon brand or install a water softener.
	Water is not hot enough	• Make sure water heater is delivering water at 120°F–140°F (48°C–60°C).
	Washer is overloaded	• Select load size to match clothes load.
	Detergent is not dissolving	• Add detergent as wash basket fills with water before you load clothes.
	Dye transfer	• Sort clothes by color. If fabric label states <i>wash separately</i> , unstable dyes may be indicated.

<b>Lint or residue on clothes</b>	Clothes are air or line dried	• If you do not dry your clothes with a clothes dryer, your clothes may retain more lint.
	Incorrect sorting	• Separate lint producers from lint collectors.
	Washing too long	• Wash small loads for a shorter time than larger loads.
	Detergent not dissolving	• Add detergent as wash basket fills with water, before you load clothes.
		• Try a liquid detergent.
		• Use warmer water temperature.
	Overloading	• Load clothes no higher than the top row of holes in the washer tub. • Make sure load size selector matches clothes load size.
Incorrect use of fabric softener	• Check fabric softener package for instructions and follow directions for using dispenser.	

<b>PERFORMANCE (cont.)</b>	<b>Possible Causes</b>	<b>What To Do</b>
<b>Pilling</b>	Result of normal wear on poly-cotton blends and fuzzy fabrics	<ul style="list-style-type: none"> <li>While this is not caused by the washer, you can slow the pilling process by washing garments inside out.</li> </ul>
<b>Snags, holes, tears, rips or excessive wear</b>	Pins, snaps, hooks, sharp buttons, belt buckles, zippers and sharp objects left in pockets	<ul style="list-style-type: none"> <li>Fasten snaps, hooks, buttons and zippers.</li> <li>Remove loose items like pins, objects in pockets and sharp buttons.</li> <li>Turn knits (which snag easily) inside out.</li> </ul>
	Undiluted chlorine bleach	<ul style="list-style-type: none"> <li>Check bleach package instructions for proper amount.</li> <li>Never add undiluted bleach to wash or allow clothes to come in contact with undiluted bleach.</li> </ul>
	Chemicals like hair bleach or dye, permanent wave solution	<ul style="list-style-type: none"> <li>Rinse items that may have chemicals on them before washing.</li> </ul>
<b>Wrinkling</b>	Improper sorting	<ul style="list-style-type: none"> <li>Avoid mixing heavy items (like work clothes) with light items (like blouses).</li> <li>Try a fabric softener.</li> </ul>
	Overloading or incorrect water level	<ul style="list-style-type: none"> <li>Load your washer so clothes have enough room to move freely.</li> </ul>
	Incorrect wash and dry cycles	<ul style="list-style-type: none"> <li>Match Cycle selection to the type of fabric you are washing (especially for easy care loads).</li> </ul>
	Repeated washing in water that is too hot	<ul style="list-style-type: none"> <li>Wash in warm or cold water.</li> </ul>
<b>NOISE</b>	<b>Possible Causes</b>	<b>What To Do</b>
<b>Washer is noisy</b>	Washer is uneven	<ul style="list-style-type: none"> <li>To level the front of the washer, adjust the front leveling legs by rotating the individual leg in the proper direction for up or down. To level back of washer, lift back of machine 4" (11 cm) and set down.</li> </ul>
	Washer load is unbalanced	<ul style="list-style-type: none"> <li>Push the Cycle knob in to stop the washer, open the lid and redistribute the load evenly. Close the lid and restart.</li> </ul>
	Shipping rod is still assembled in unit	<ul style="list-style-type: none"> <li>To remove shipping rod from washer, pull yellow tag and attached rod from the bottom right hand side of washer.</li> </ul>
	Washer is sitting too close to wall (causes knocking during cycle)	<ul style="list-style-type: none"> <li>Pull washer away from the wall; about 4" (11 cm) is needed.</li> </ul>
<b>OTHER</b>	<b>Possible Causes</b>	<b>What To Do</b>
<b>Labels on the exterior of the washer will not peel off cleanly</b>	Occasionally the adhesive used on the labels does not release cleanly	<ul style="list-style-type: none"> <li>Use a hair dryer set at the lowest heat setting, directing the air at the label for a short amount of time. This will release the adhesive easily, without damaging the surface of the washer.</li> </ul>

**Notes.**

---

**Consumer Support**

**Troubleshooting Tips**

**Operating Instructions**

**Safety Instructions**

# GE Washer Warranty.



All warranty service provided by our Factory Service Centers, or an authorized Customer Care<sup>®</sup> technician. To schedule service, on-line, 24 hours a day, visit us at [www.GEAppliances.com](http://www.GEAppliances.com), or call 800.GE.CARES (800.432.2737).

Staple your receipt here. Proof of the original purchase date is needed to obtain service under the warranty.

<b>For The Period Of:</b>	<b>We Will Replace:</b>
<b>One Year</b> From the date of the original purchase	<b>Any part</b> of the washer which fails due to a defect in materials or workmanship. During this <b>full one-year warranty</b> , we will also provide, <b>free of charge</b> , all labor and related service to replace the defective part.
<b>Second through Fifth Year</b> From the date of the original purchase	<b>The transmission, suspension rod and spring assembly</b> if any of these parts should fail due to a defect in materials or workmanship. GE will also replace <b>the washer lid or cover</b> , if they should rust under operating conditions. During this <b>additional four-year limited warranty</b> , you will be responsible for any labor or related service costs.
<b>Second through Tenth Year</b> From the date of the original purchase	<b>The washer tub</b> , if it should fail due to a defect in materials or workmanship. During this <b>additional nine-year limited warranty</b> , you will be responsible for any labor or related service costs.
<b>Second through Twentieth Year</b> From the date of the original purchase	<b>The washer basket</b> , if it should fail due to a defect in materials or workmanship. During this <b>additional nineteen-year limited warranty</b> , you will be responsible for any labor or related service costs.

## What Is Not Covered:

- Service trips to your home to teach you how to use the product.
- Improper installation.
- Failure of the product if it is abused, misused, or used for other than the intended purpose or used commercially.
- Replacement of house fuses or resetting of circuit breakers.
- Damage to the product caused by accident, fire, floods or acts of God.
- Incidental or consequential damage caused by possible defects with this appliance.

*This warranty is extended to the original purchaser and any succeeding owner for products purchased for home use within the USA. In Alaska, the warranty excludes the cost of shipping or service calls to your home.*

*Some states do not allow the exclusion or limitation of incidental or consequential damages. This warranty gives you specific legal rights, and you may also have other rights which vary from state to state. To know what your legal rights are, consult your local or state consumer affairs office or your state's Attorney General.*

**Warrantor: General Electric Company. Louisville, KY 40225**

## Consumer Support.

---



### *GE Appliances Website*

[www.GEAppliances.com](http://www.GEAppliances.com)

Have a question or need assistance with your appliance? Try the GE Appliances Website 24 hours a day, any day of the year! For greater convenience and faster service, you can now download Owner's Manuals, order parts, catalogs, or even schedule service on-line. You can also "Ask Our Team of Experts™" your questions, and so much more...



### *Schedule Service*

[www.GEAppliances.com](http://www.GEAppliances.com)

Expert GE repair service is only one step away from your door. Get on-line and schedule your service at your convenience 24 hours any day of the year! Or call 800.GE.CARES (800.432.2737) during normal business hours.



### *Real Life Design Studio*

[www.GEAppliances.com](http://www.GEAppliances.com)

GE supports the Universal Design concept—products, services and environments that can be used by people of all ages, sizes and capabilities. We recognize the need to design for a wide range of physical and mental abilities and impairments. For details of GE's Universal Design applications, including kitchen design ideas for people with disabilities, check out our Website today. For the hearing impaired, please call 800.TDD.GEAC (800.833.4322).



### *Extended Warranties*

[www.GEAppliances.com](http://www.GEAppliances.com)

Purchase a GE extended warranty and learn about special discounts that are available while your warranty is still in effect. You can purchase it on-line anytime, or call 800.626.2224 during normal business hours. GE Consumer Home Services will still be there after your warranty expires.

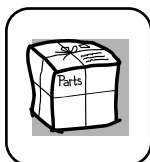

### *Parts and Accessories*

[www.GEAppliances.com](http://www.GEAppliances.com)

Individuals qualified to service their own appliances can have parts or accessories sent directly to their homes (VISA, MasterCard and Discover cards are accepted). Order on-line today, 24 hours every day or by phone at 800.626.2002 during normal business hours.

***Instructions contained in this manual cover procedures to be performed by any user. Other servicing generally should be referred to qualified service personnel. Caution must be exercised, since improper servicing may cause unsafe operation.***

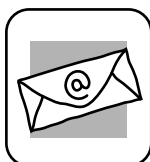

### *Contact Us*

[www.GEAppliances.com](http://www.GEAppliances.com)

If you are not satisfied with the service you receive from GE, contact us on our Website with all the details including your phone number, or write to: General Manager, Customer Relations  
GE Appliances, Appliance Park  
Louisville, KY 40225



### *Register Your Appliance*

[www.GEAppliances.com](http://www.GEAppliances.com)

**Register your new appliance on-line—at your convenience!** Timely product registration will allow for enhanced communication and prompt service under the terms of your warranty, should the need arise. You may also mail in the pre-printed registration card included in the packing material.