

This Owner's Manual is provided and hosted by [Appliance Factory Parts](http://Appliance Factory Parts).

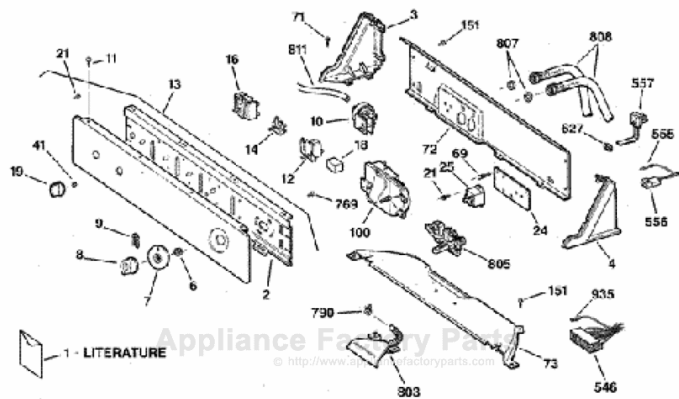

# GE WCSR4110TCWW Owner's Manual

[Shop genuine replacement parts for GE  
WCSR4110TCWW](#)



[Find Your GE Washer Parts - Select From 4591 Models](#)

----- Manual continues below -----



GE Appliances

# Washers



*Owner's Manual*

WCSR4110

WDSR4110



GE Answer Center® 800.626.2000

Part No. 175D1807P215 Pub. No. 49-9950

# ***Congratulations!*** ***You Are Now Part of the GE Family.***

---

Welcome to the GE family. We're proud of our quality products and we are committed to providing dependable service. You'll see it in this easy-to-use Owner's Manual and you'll hear it in the friendly voices of our customer service department.

Best of all, you'll experience these values each time you do the laundry. That's important, because your new washer will be part of your family for many years. And we hope you will be part of ours for a long time to come.

We thank you for buying GE. We appreciate your purchase, and hope you will continue to rely on us whenever you need quality appliances for your home.



---

## ***Important!***

***Staple sales slip or cancelled check here.***

*Proof of the original purchase date is needed to obtain service under the warranty.*

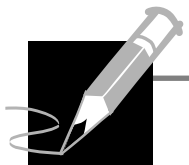

---

***Write the washer model and serial numbers here.***

# \_\_\_\_\_

# \_\_\_\_\_

*You can find them behind the top edge of the control panel.*

# GE & You, A Service Partnership.

Ask any GE appliance owner and they will tell you we stand behind our products with unmatched quality service. However, did you know that most questions result from simple problems that you can easily fix yourself in just a few minutes? This Owner's Manual can tell you how.



## Read this manual

Inside you will find many helpful hints on how to use and maintain your washer properly. Just a little preventive care on your part can save you a great deal of time and money over the life of your washer.



## Review the section on Troubleshooting Tips

You'll find many answers to common problems here. If you review our chart of Troubleshooting Tips first, you may not need to call for service at all.



## If you need service

If you do need service, you can relax knowing help is only a phone call away. A list of toll-free customer service numbers is included in the back section. Or you can always call the GE Answer Center® at 800.626.2000, 24 hours a day, 7 days a week.

### Safety Information . . . . .4-7

Safety Information

### Operating Instructions

- Control Panel . . . . .8
- Control Settings . . . . .8, 9
- Washer Features . . . . .10-12
- Loading and Using the Washer . . . . .13, 14

Operating Instructions

### Troubleshooting Tips

- Before You Call For Service . . . . .15-19

Troubleshooting Tips

### Customer Service

- Warranty Information . . . . .23
- Customer Service Numbers . . . .Back Cover

Customer Service

## ***IMPORTANT SAFETY INFORMATION. READ ALL INSTRUCTIONS BEFORE USING.***

### **⚠ WARNING!**

*For your safety, the information in this manual must be followed to minimize the risk of fire or explosion, electric shock, or to prevent property damage, personal injury, or loss of life.*



### **WATER HEATER SAFETY**

*Under certain conditions hydrogen gas may be produced in a water heater that has not been used for two weeks or more. Hydrogen gas can be explosive under these circumstances.*

If the hot water has not been used for two weeks or more, prevent the possibility of damage or injury by turning on all hot water faucets and allowing them to run for several minutes. Do this before using any electrical appliance which is connected to the hot water system. This simple procedure will allow any built-up hydrogen gas to escape. Since the gas is flammable, do not smoke or use an open flame or appliance during this process.



## PROPER INSTALLATION

*This washer must be properly installed and located in accordance with the Installation Instructions before it is used. If you did not receive an Installation Instructions sheet, you can receive one by calling us toll-free at the GE Answer Center<sup>®</sup>, 800.626.2000.*

- Install or store where it will not be exposed to temperatures below freezing or exposed to the weather.
- Properly ground washer to conform with all governing codes and ordinances. Follow details in Installation Instructions.



## YOUR LAUNDRY AREA

- Keep the area underneath and around your appliances free of combustible materials such as lint, paper, rags, chemicals, etc.
- Close supervision is necessary if this appliance is used by or near children. Do not allow children to play on, with, or inside this or any other appliance.

## **IMPORTANT SAFETY INSTRUCTIONS. READ ALL INFORMATION BEFORE USING.**

### **⚠ WARNING!**

Use this appliance only for its intended purpose as described in this Owner's Manual.



### **WHEN USING THE WASHER**

- Never reach into washer while it is moving. Wait until the machine has completely stopped before opening the lid.
- Do not mix chlorine bleach with ammonia or acids such as vinegar and/or rust remover. Mixing different chemicals can produce a toxic gas which may cause death.
- Do not wash or dry articles that have been cleaned in, washed in, soaked in, or spotted with combustible or explosive substances (such as wax, oil, paint, gasoline, degreasers, dry-cleaning solvents, kerosene, etc.) which may ignite or explode. Do not add these substances to the wash water. Do not use or place these substances around your washer or dryer during operation.
- The laundry process can reduce the flame retardancy of fabrics. To avoid such a result, carefully follow the garment manufacturer's wash and care instructions.
- To minimize the possibility of electric shock, unplug this appliance from the power supply or disconnect the washer at the household distribution panel by removing the fuse or switching off the circuit breaker before attempting any maintenance or cleaning.  
**NOTE:** Turning the Cycle Selector knob to an off position does **NOT** disconnect the appliance from the power supply.
- Never attempt to operate this appliance if it is damaged, malfunctioning, partially disassembled, or has missing or broken parts, including a damaged cord or plug.



## WHEN NOT IN USE

- Turn off water faucets to relieve pressure on hoses and valves and to minimize leakage if a break or rupture should occur. Check the condition of the fill hoses; they may need replacement after 5 years.
- Before discarding a washer, or removing it from service, remove the washer lid to prevent children from hiding inside.
- Do not attempt to repair or replace any part of this appliance unless specifically recommended in this Owner's Manual, or in published user-repair instructions that you understand and have the skills to carry out.
- Do not tamper with controls.



## REMEMBER...

*Your continued health and safety are important to us.*

*Please read and follow this Safety Information carefully.*

*We want you to remain a happy and healthy part of our GE family.*

## SAVE THESE INSTRUCTIONS

## About the washer control panel.

You can locate your model number behind the top edge of the control panel.

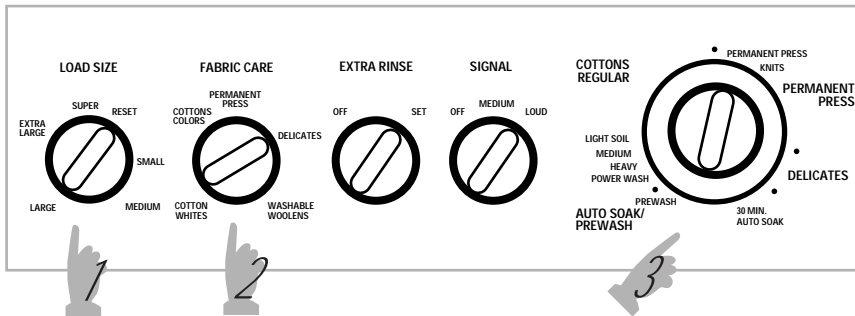

### Control Settings



#### 1 Load Size

The water level should just cover the clothes. Adjust the load size accordingly. Loosely load clothes no higher than the top row of holes in the washer tub.

To increase the water level after you've made a selection, select RESET and a new level.



#### 2 Fabric Care

Select the water temperature for the wash and rinse cycles. Always follow the fabric manufacturer's care label or instructions when laundering. Follow the water temperature guide on washer lid.



### **Wash Cycle**

The wash cycle controls the length of the washing process. The chart below will help you match the wash cycle setting with your clothing.

<b>REGULAR</b>	For heavy to lightly soiled cottons, household linens, work and play clothes.
<b>PERM PRESS</b>	For easy care and wrinkle-resistant items.
<b>KNITS</b>	Specially designed for normally soiled knits.
<b>DELICATES</b>	For lingerie and delicate fabrics with light to normal soil.
<b>AUTO SOAK</b>	For heavily soiled clothes. Begins with a brief agitation, soaks for a specified period of time, then moves through the rest of the cycle automatically.
<b>PREWASH</b>	For heavily soiled clothes or for clothes with a care label that recommends prewashing before wearing.
<b>POWER WASH</b>	For heavily soiled and heavy-duty fabrics. This cycle provides a longer agitation.

## About the washer features.

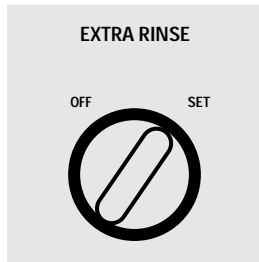

### Extra Rinse

When you use extra detergent or bleach to clean heavily soiled clothes, you may want to use the **EXTRA RINSE** option. This option provides a second deep cold rinse in the Regular cycle. Turn the **EXTRA RINSE** knob to **SET**.

*The washer will pause for a few minutes before the EXTRA RINSE option begins.*

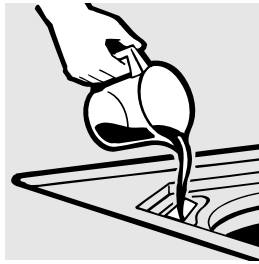

### Liquid Bleach Dispenser

The dispenser dilutes liquid chlorine bleach before it reaches into your wash load.

- 1 Check clothing care labels for special instructions.
- 2 Measure liquid bleach carefully, following instructions on the bottle.
- 3 Before starting the washer, pour measured amount of bleach directly into bleach dispenser. Avoid splashing or over-filling dispenser. If you prefer to use powdered bleach, add it into the wash basket with your detergent.



*Never pour undiluted liquid chlorine bleach directly onto clothes or into the wash basket.*

*Do not pour powdered bleach into bleach dispenser.*



*Do not mix chlorine bleach with ammonia or acids such as vinegar and/or rust remover. Mixing can produce a toxic gas which may cause death.*

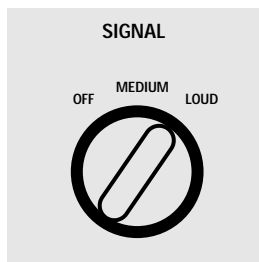

### Signal

If the **SIGNAL** option is selected, a signal will sound just before the end of the cycle. This reminds you to remove the clothes to avoid excess wrinkling before drying. If you selected **EXTRA RINSE** the signal will sound at the end of the cycle and at the end of the Extra Rinse.

### Fabric Softener Dispenser

This dispenser automatically releases liquid fabric softener at the proper time during the cycle. To use, follow these steps:

- 1 Make sure dispenser is securely attached to agitator.
- 2 Use only liquid fabric softener. Pour into dispenser, using amount recommended on package.
- 3 Add water to dispenser until it reaches the maximum fill line.

*Do not stop the washer during the first spin. This will cause the dispenser to empty too soon.*

*Do not use the Fabric Softener Dispenser with **AUTO SOAK** or **EXTRA RINSE**.*

*Never pour fabric softener directly on clothes. It may stain them.*



*Do not pour anything into the agitator if the top is removed.*

### Cleaning the Fabric Softener Dispenser

- 1 Remove the dispenser from the top of the agitator.
- 2 Separate the dispenser cup from the cover by grasping the top and pushing down on the inside of the cup with your fingers. Dispenser cup will pop free from the cover.
- 3 To clean dispenser, soak both the dispenser cup and the dispenser cover in the following solution:
  - 1 US gallon (3.8 liters) warm water
  - 1/4 cup (60 ml) heavy duty liquid detergent
  - 1 cup (240 ml) bleach
- 4 If necessary, loosen build-up with a clean, soft cloth after soaking. Do not use a stiff brush; you may roughen the surface of the dispenser.
- 5 Rinse and reassemble dispenser. Place dispenser back on the agitator.

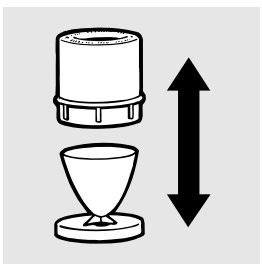

*Separate for cleaning.*

## About the washer features.

NOTE: Not all features are available on all washer models.

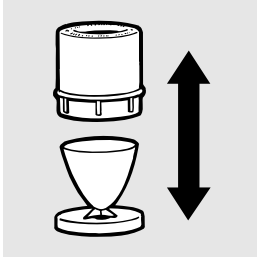

Separate for cleaning.

### Cleaning the Fabric Softener Dispenser (on some models)

- 1 Remove the dispenser from the top of the agitator.
- 2 Separate the dispenser cup from the cover by grasping the top and pushing down on the inside of the cup with your fingers. Dispenser cup will pop free from the cover.
- 3 To clean dispenser, soak both the dispenser cup and the dispenser cover in the following solution:
  - 1 US gallon (3.8 liters) warm water
  - 1/4 cup (60 ml) heavy duty liquid detergent
  - 1 cup (240 ml) bleach
- 4 If necessary, loosen build-up with a clean, soft cloth after soaking. Do not use a stiff brush; you may roughen the surface of the dispenser.
- 5 Rinse and reassemble dispenser. Place dispenser back on the agitator.

## Loading and using the washer.

Always follow fabric manufacturer's care label when laundering.



### Sorting Wash Loads

<b>Colors</b>	Whites	Lights	Darks
<b>Soil</b>	Heavy	Normal	Light
<b>Fabric</b>	Delicates	Easy Care	Sturdy Cottons
<b>Lint</b>	Lint Producers	Lint Collectors	

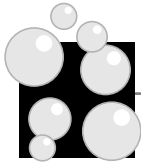

### Proper Use of Detergent

Add detergent and start the washer before adding clothes so that the detergent can work effectively. Follow the detergent package directions. Using too little detergent is a common cause of laundry problems. Use more detergent if you have hard water, large loads, greasy or oily soils or lower water temperature.



### Loading the Washer

Load dry items loosely, no higher than the top row of holes in the washer tub. When loading wet items make sure you set the load/water level high enough to allow the items to move freely. Water level should just cover the clothes. To add items after washer has started, push in Cycle knob and submerge additional items next to the agitator. Close the lid and pull Cycle knob out to restart.

*Do not wrap large items like sheets around the agitator.*

*Do not wash fabrics containing flammable materials (waxes, cleaning fluids, etc.).*

*Washer will not start with the lid up.*

## Loading and using the washer.



### Care and Cleaning of the Washer

**Wash Basket:** Leave the lid open after washing to allow moisture to evaporate. If you want to clean the basket use a clean soft cloth dampened with liquid detergent, then rinse. (Do not use harsh or gritty cleaners.)

**Fill Hoses:** Hoses connecting washer to faucet should be replaced every 5 years.

**Lint Filter:** The lint filter is located under the agitator. It is self-cleaning and requires no maintenance.

**Exterior:** Immediately wipe off any spills. Wipe with damp cloth. Try not to hit surface with sharp objects.

**Moving and Storage:** Ask the service technician to remove water from drain pump and hoses. Do not store the washer where it will be exposed to the weather. Call the GE Answer Center<sup>®</sup>, 800.626.2000 for information on how to keep the tub stationary when moving the washer.

**Long Vacations:** Be sure water supply is shut off at faucets. Drain all water from hoses if weather will be below freezing.

## Before you call for service...



### Troubleshooting Tips

Save time and money! Review the charts on the following pages first and you may not need to call for service.

Problem	Possible Causes	What To Do
<i>Washer won't operate</i>	<b>Washer is unplugged</b>	<ul style="list-style-type: none"> <li>• Make sure cord is plugged securely into a working outlet.</li> </ul>
	<b>Water supply is turned off</b>	<ul style="list-style-type: none"> <li>• Turn both hot and cold faucets fully on.</li> </ul>
	<b>Controls are not set properly</b>	<ul style="list-style-type: none"> <li>• Check controls and make sure Cycle knob is pulled out to <b>ON</b> position.</li> </ul>
	<b>Lid is open</b>	<ul style="list-style-type: none"> <li>• Close lid and pull Cycle knob out to <b>ON</b> position.</li> </ul>
	<b>Circuit breaker/fuse is tripped/blown</b>	<ul style="list-style-type: none"> <li>• Check house circuit breakers /fuses. Replace fuses or reset breaker. Washer should have separate outlet.</li> </ul>
<i>Water temperature is incorrect</i>	<b>Control is not set properly</b>	<ul style="list-style-type: none"> <li>• Check water temperature control and adjust.</li> </ul>
	<b>Water supply is turned off or improperly connected</b>	<ul style="list-style-type: none"> <li>• Turn both hot and cold faucets fully on and make sure hoses are connected to correct faucets.</li> </ul>
	<b>Water valve screens are stopped up</b>	<ul style="list-style-type: none"> <li>• Turn off the water source and remove the water connection hoses from the upper back of the washer. Use a brush or toothpick to clean the screens in the machine. Reconnect the hoses and turn the water back on.</li> </ul>
	<b>House water heater is not set properly</b>	<ul style="list-style-type: none"> <li>• Make sure house water heater is delivering water at 120°F.-140°F. (48°C.-60°C.).</li> </ul>

## Before you call for service...



### Troubleshooting Tips

<i>Problem</i>	<i>Possible Causes</i>	<i>What To Do</i>
<i>Water won't drain</i>	<b>Drain hose is kinked or improperly connected</b>	<ul style="list-style-type: none"> <li>• Straighten drain hose and make sure washer is not sitting on it.</li> <li>• Top of drain outlet should be less than 8 ft. above floor.</li> </ul>
<i>Water leaks</i>	<b>Fill hoses or drain hose is improperly connected</b>	<ul style="list-style-type: none"> <li>• Make sure hose connections are tight at faucets and make sure end of drain hose is correctly inserted in and secured to drain facility.</li> </ul>
	<b>Household drain may be clogged</b>	<ul style="list-style-type: none"> <li>• Check household plumbing. You may need to call a plumber.</li> </ul>
	<b>Constant water pressure to the fill hoses at the water source</b>	<ul style="list-style-type: none"> <li>• Tighten hoses at the faucets and turn the water off after each use.</li> <li>• Check condition of the fill hoses; they may need replacement after 5 years.</li> </ul>
<i>Washer is noisy</i>	<b>Washer is uneven</b>	<ul style="list-style-type: none"> <li>• Make sure washer is level and firm to the floor.</li> </ul>
	<b>Washer load is unbalanced</b>	<ul style="list-style-type: none"> <li>• Push the Cycle knob in to stop the washer, open the lid and redistribute the load evenly. Close the lid and restart.</li> </ul>
<i>Washer pauses in cycle</i>	<b>The washer normally pauses between washing steps</b>	
<i>Clothes too wet</i>	<b>Incorrect cycle selected</b>	<ul style="list-style-type: none"> <li>• Make sure the cycle selected matches the load you are washing.</li> </ul>

<b>Problem</b>	<b>Possible Causes</b>	<b>What To Do</b>
<i>Lint or residue on clothes</i>	<b>Incorrect sorting</b>	<ul style="list-style-type: none"> <li>• Separate lint producers from lint collectors.</li> </ul>
	<b>Washing too long</b>	<ul style="list-style-type: none"> <li>• Wash small loads for a shorter time than larger loads.</li> </ul>
	<b>Detergent not dissolving</b>	<ul style="list-style-type: none"> <li>• Add detergent as wash basket fills with water, before you load clothes.</li> <li>• Try a liquid detergent.</li> <li>• Use warmer water temperature.</li> </ul>
	<b>Overloading</b>	<ul style="list-style-type: none"> <li>• Load clothes no higher than the top row of holes in the washer tub.</li> <li>• Make sure load size selector matches clothes load size.</li> </ul>
	<b>Incorrect use of fabric softener</b>	<ul style="list-style-type: none"> <li>• Check fabric softener package for instructions and follow directions for using dispenser.</li> </ul>
<i>Colored spots</i>	<b>Incorrect use of fabric softener</b>	<ul style="list-style-type: none"> <li>• Check fabric softener package for instructions and follow directions for using dispenser.</li> <li>• Pretreat stain and rewash.</li> </ul>
	<b>Dye transfer</b>	<ul style="list-style-type: none"> <li>• Sort whites or lightly colored items from dark colors.</li> </ul>

## Before you call for service...



### Troubleshooting Tips

<b>Problem</b>	<b>Possible Causes</b>	<b>What To Do</b>
<b>Wrinkling</b>	<b>Improper sorting</b>	<ul style="list-style-type: none"> <li>• Avoid mixing heavy items (like work clothes) with light items (like blouses).</li> <li>• Try a fabric softener.</li> </ul>
	<b>Overloading or incorrect water level</b>	<ul style="list-style-type: none"> <li>• Load your washer so clothes have enough room to move freely.</li> </ul>
	<b>Incorrect wash and dry cycles</b>	<ul style="list-style-type: none"> <li>• Match Cycle selection to the type of fabric you are washing (especially for easy care loads).</li> </ul>
	<b>Repeated washing in water that is too hot</b>	<ul style="list-style-type: none"> <li>• Wash in warm or cold water with plenty of detergent.</li> </ul>
<b>Too many suds</b>	<b>Type of detergent</b>	<ul style="list-style-type: none"> <li>• Switch to a lower sudsing detergent brand and follow instructions on package.</li> </ul>
	<b>Very soft water</b>	<ul style="list-style-type: none"> <li>• Try less detergent.</li> </ul>
<b>Snags, holes, tears, rips or excessive wear</b>	<b>Pins, snaps, hooks, sharp buttons, belt buckles zippers, and sharp objects left in pockets</b>	<ul style="list-style-type: none"> <li>• Fasten snaps, hooks, buttons, and zippers.</li> <li>• Remove loose items like pins, objects in pockets and sharp buttons.</li> <li>• Turn knits (which snag easily) inside out.</li> </ul>
	<b>Undiluted chlorine bleach</b>	<ul style="list-style-type: none"> <li>• Check bleach package instructions for proper amount.</li> <li>• Never add undiluted bleach to wash or allow clothes to come in contact with undiluted bleach.</li> </ul>
	<b>Chemicals like hair bleach or dye, permanent wave solution</b>	<ul style="list-style-type: none"> <li>• Rinse items that may have chemicals on them before washing.</li> </ul>

<b>Problem</b>	<b>Possible Causes</b>	<b>What To Do</b>
<b>Pilling</b>	<b>Result of normal wear on poly-cotton blends and fuzzy fabrics</b>	<ul style="list-style-type: none"> <li>While this is not caused by the washer, you can slow the pilling process by washing garments inside out.</li> </ul>
<b>Grayed or yellowed clothes</b>	<b>Not enough detergent</b>	<ul style="list-style-type: none"> <li>Use more detergent (especially with larger loads).</li> </ul>
	<b>Hard water</b>	<ul style="list-style-type: none"> <li>Use a water conditioner like Calgon brand or install a water softener.</li> </ul>
	<b>Water is not hot enough</b>	<ul style="list-style-type: none"> <li>Make sure water heater is delivering water at 120°F.–140°F. (48°C.–60°C.).</li> </ul>
	<b>Washer is overloaded</b>	<ul style="list-style-type: none"> <li>Select load size to match clothes load.</li> </ul>
	<b>Detergent is not dissolving</b>	<ul style="list-style-type: none"> <li>Add detergent as wash basket fills with water before you load clothes.</li> </ul>
	<b>Dye transfer</b>	<ul style="list-style-type: none"> <li>Sort clothes by color. If fabric label states <i>wash separately</i>, unstable dyes may be indicated.</li> </ul>



*Safety Information*

*Operating Instructions*

*Troubleshooting Tips*

*Customer Service*

## **Notes**

---

# GE Washer Warranty



All warranty service provided by our Factory Service Centers, or an authorized Customer Care® technician. For service, call 800-GE-CARES.

For The Period Of:	GE Will Replace, At No Charge To You:
<b>One Year</b> From the date of the original purchase	<b>Any part</b> of the washer which fails due to a defect in materials or workmanship. During this <b>full one-year warranty</b> , GE will also provide, <b>free of charge</b> , all labor and in-home service to replace the defective part.
<b>Five Years</b> From the date of the original purchase	<b>The transmission, suspension rod and spring assembly</b> , if any of these parts should fail due to a defect in materials or workmanship. GE will also replace the <b>washer lid or cover</b> , if they should rust under normal operating conditions. During this <b>five-year limited warranty</b> , you will be responsible for any labor or in-home service costs.
<b>Ten Years</b> From the date of the original purchase	<b>The washer tub</b> , if it should fail due to a defect in materials or workmanship. During this <b>ten-year limited warranty</b> , you will be responsible for any labor or in-home service costs.
<b>Twenty Years</b> From the date of the original purchase	<b>The washer basket</b> , if it should fail due to a defect in materials or workmanship. During this <b>twenty-year limited warranty</b> , you will be responsible for any labor or in-home service costs.

## What GE Will Not Cover:

- Service trips to your home to teach you how to use the product.
- Replacement of house fuses or resetting of circuit breakers.
- Improper installation.
- Damage to the product caused by accident, fire, floods or acts of God.
- Failure of the product if it is abused, misused, or used for other than the intended purpose or used commercially.
- Incidental or consequential damage to personal property caused by possible defects with this appliance.

This warranty is extended to the original purchaser and any succeeding owner for products purchased for home use within the USA. In Alaska, the warranty excludes the cost of shipping or service calls to your home.

Some states do not allow the exclusion or limitation of incidental or consequential damages. This warranty gives you specific legal rights, and you may also have other rights which vary from state to state. To know what your legal rights are, consult your local or state consumer affairs office or your state's Attorney General.

## Service Telephone Numbers.

---



### GE Answer Center® 800.626.2000

---

The GE Answer Center® is open 24 hours a day, 7 days a week.



### In-Home Repair Service 800-GE-CARES (800-432-2737)

---

Expert GE repair service is only a phone call away.



### Special Needs Service 800.626.2000

---

#### TDD 800-TDD-GEAC (800-833-4322)

GE offers, free of charge, Braille controls for a variety of GE appliances and a brochure to assist in planning a barrier-free kitchen for persons with limited mobility.



### Service Contracts 800-626-2224

---

Purchase a GE service contract while your warranty is still in effect and you'll receive a substantial discount. GE Consumer Service will still be there after your warranty expires.

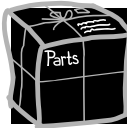

### Parts and Accessories 800-626-2002

---

Individuals qualified to service their own appliances can have parts or accessories sent directly to their homes (VISA, MasterCard and Discover cards are accepted).

**Instructions contained in this manual cover procedures to be performed by any user. Other servicing generally should be referred to qualified service personnel. Caution must be exercised, since improper servicing may cause unsafe operation.**



### Service Satisfaction

---

If you are not satisfied with the service you receive from GE, follow these three steps. **First**, contact the people who serviced your appliance. **Next**, if you are still not pleased, write all the details—including your phone number—to: Manager, Consumer Relations, GE Appliances, Appliance Park, Louisville, KY 40225. **Finally**, if your problem is still not resolved, write:

Major Appliance Consumer Action Program  
20 North Wacker Drive, Chicago, IL 60606.