

This Owner's Manual is provided and hosted by Appliance Factory Parts.

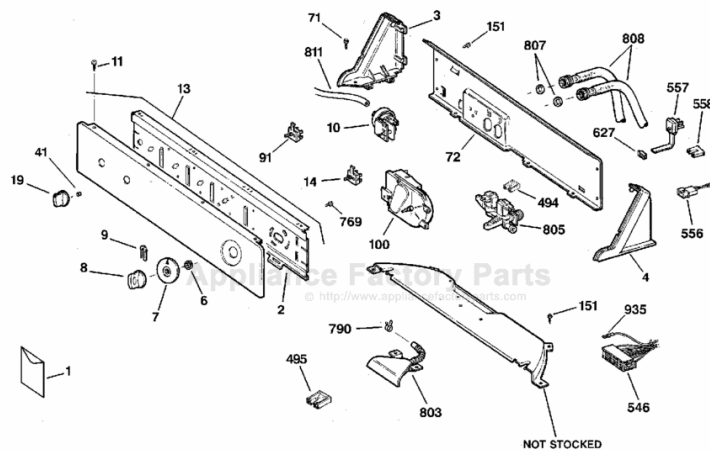

GE WHDRR418G2WW Owner's Manual

[Shop genuine replacement parts for GE
WHDRR418G2WW](#)



(ART NO. WH6321 C5)

NOTE: HARNESS WIRE WH19X0163

[Find Your GE Washer Parts - Select From 4591 Models](#)

----- Manual continues below -----

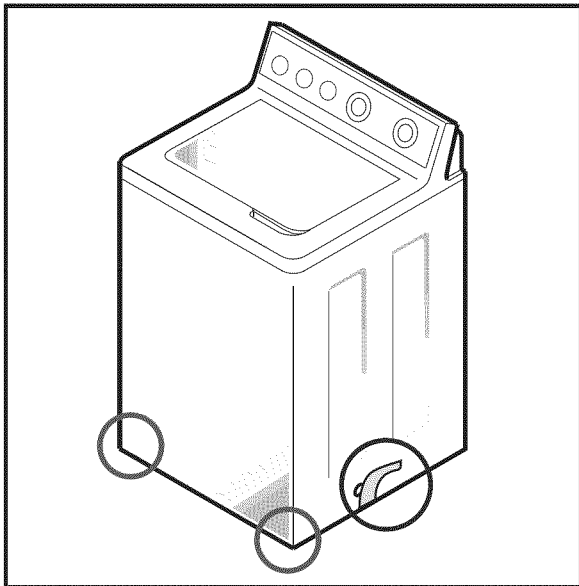

Circles or ovals are color matched between pictures to help show location on product

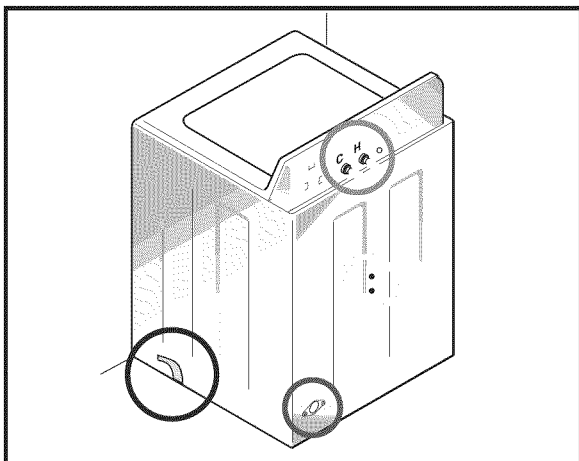

Tools you will need

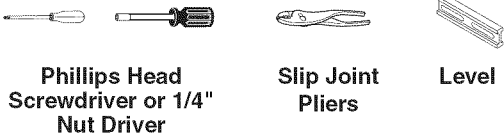

GROUNDING INSTRUCTIONS

This appliance must be grounded. In the event of malfunction or breakdown, grounding should reduce the risk of electric shock by providing a path of least resistance for electric current. This appliance is equipped with a cord having an equipment-grounding conductor and a grounding plug. The plug must be plugged into an appropriate outlet that is properly installed and grounded in accordance with all local codes and ordinances.

WARNING – Improper connection of equipment-grounding conductor can result in a risk of electric shock. Check with a qualified electrician or serviceman if you are in doubt as to whether the appliance is properly grounded.

1. Unpack your washer

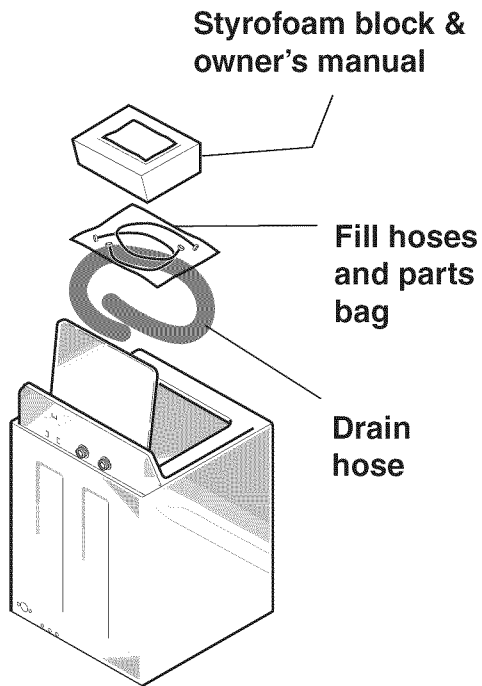

2. Remove bottom panel



Avoid a Repair!

Remove in place to avoid damage

5. Connect water supply hoses to wall faucets

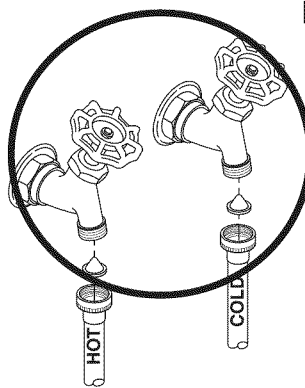

Install screens. (Screens should be brand new. Replace them if they are old or worn). Use pliers to tighten 1/2 turn beyond hand-tight

Avoid a Repair!

Install screen washers; without them debris will clog the valve and flooding will occur

Avoid a Repair!

Do not mix hot and cold water supplies. Mixing them will result in poor wash performance

6. Connect hoses to drain

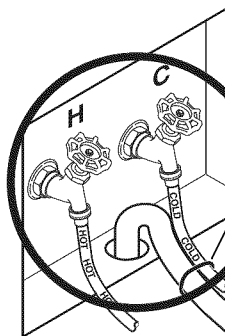

Avoid a Repair!

Meet requirements for proper installation