

This Owner's Manual is provided and hosted by [Appliance Factory Parts](http://www.appliancefactoryparts.com).

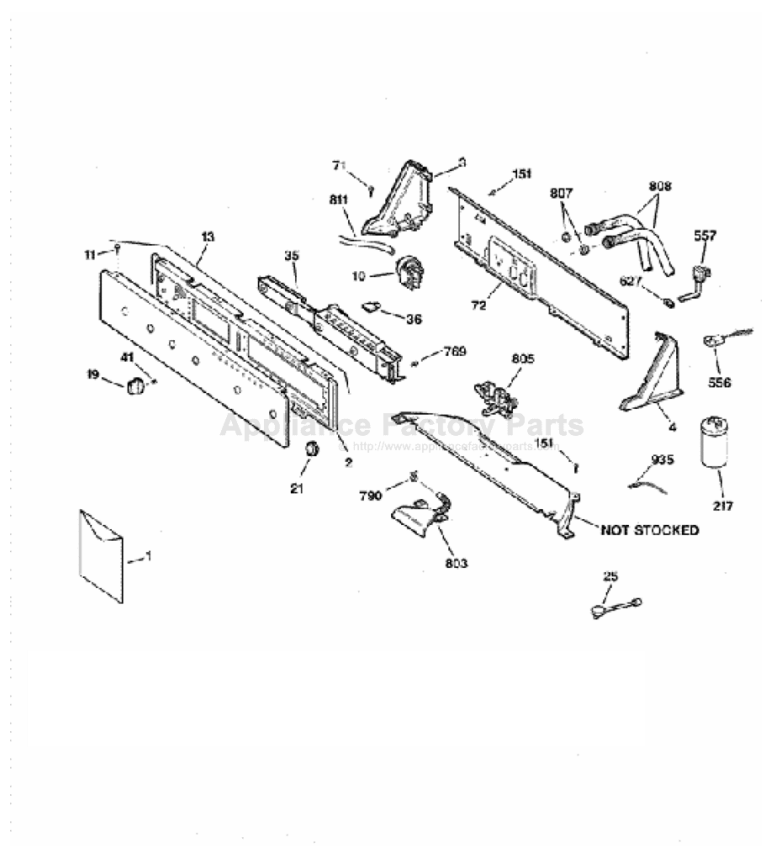

GE WHDSE820C1WW Owner's Manual

[Shop genuine replacement parts for GE
WHDSE820C1WW](#)



[Find Your GE Washer Parts - Select From 4591 Models](#)

----- Manual continues below -----



Washers

Safety Instructions2, 3

Operating Instructions

Control Panels4-6

Control Settings7, 8

Features9, 10

Loading and Using
the Washer10, 11

Troubleshooting Tips12-14

Consumer Support

Consumer Support . . .Back Cover
Warranty15

Owner's Manual

S4200

WASE5210

WBSE3120

WCSE4160

WHDSE820

WJSE4150

WLE4000

WSSE5210

WWSE5200

Write the model and serial numbers here:

Model # _____

Serial # _____

You can find them in the upper right corner on the back of your washer.



IMPORTANT SAFETY INFORMATION. READ ALL INSTRUCTIONS BEFORE USING.

⚠ WARNING! For your safety, the information in this manual must be followed to minimize the risk of fire or explosion, electric shock, or to prevent property damage, personal injury, or loss of life.



WATER HEATER SAFETY

Under certain conditions hydrogen gas may be produced in a water heater that has not been used for two weeks or more. Hydrogen gas can be explosive under these circumstances.

If the hot water has not been used for two weeks or more, prevent the possibility of damage or injury by turning on all hot water faucets and allowing them to run for several minutes. Do this before using any electrical appliance which is connected to the hot water system. This simple procedure will allow any built-up hydrogen gas to escape. Since the gas is flammable, do not smoke or use an open flame or appliance during this process.



PROPER INSTALLATION

This washer must be properly installed and located in accordance with the Installation Instructions before it is used. If you did not receive an Installation Instructions sheet, you can receive one by visiting GEAppliances.com, or by calling **800.GE.CARES** (800.432.2737).

- Install or store where it will not be exposed to temperatures below freezing or exposed to the weather.
- Properly ground washer to conform with all governing codes and ordinances. Follow details in Installation Instructions.



YOUR LAUNDRY AREA

- Keep the area underneath and around your appliances free of combustible materials such as lint, paper, rags, chemicals, etc.
- Close supervision is necessary if this appliance is used by or near children. Do not allow children to play on, with, or inside this or any other appliance.



WHEN USING THE WASHER

Use this appliance only for its intended purpose as described in this Owner's Manual.

- Never reach into washer while it is moving. Wait until the machine has completely stopped before opening the lid.
- Do not mix chlorine bleach with ammonia or acids such as vinegar and/or rust remover. Mixing different chemicals can produce a toxic gas which may cause death.
- Do not wash or dry articles that have been cleaned in, washed in, soaked in or spotted with combustible or explosive substances (such as wax, oil, paint, gasoline, degreasers, dry-cleaning solvents, kerosene, etc.) which may ignite or explode. Do not add these substances to the wash water. Do not use or place these substances around your washer or dryer during operation.
- The laundry process can reduce the flame retardancy of fabrics. To avoid such a result, carefully follow the garment manufacturer's wash and care instructions.
- To minimize the possibility of electric shock, unplug this appliance from the power supply or disconnect the washer at the building's distribution panel by removing the fuse or switching off the circuit breaker before attempting any maintenance or cleaning. **NOTE:** Turning the Cycle Selector Knob to an off position, or pressing PAUSE does **NOT** disconnect the appliance from the power supply.
- Never attempt to operate this appliance if it is damaged, malfunctioning, partially disassembled, or has missing or broken parts, including a damaged cord or plug.



WHEN NOT IN USE

- Turn off water faucets to relieve pressure on hoses and valves and to minimize leakage if a break or rupture should occur. Check the condition of the fill hoses; they should be replaced every 5 years.
- Before discarding a washer, or removing it from service, remove the washer lid to prevent children from hiding inside.
- Do not attempt to repair or replace any part of this appliance unless specifically recommended in this Owner's Manual, or in published user-repair instructions that you understand and have the skills to carry out.
- Do not tamper with controls.



**READ AND FOLLOW THIS SAFETY INFORMATION CAREFULLY.
SAVE THESE INSTRUCTIONS**

About the washer control panel.

1. Add detergent
 - Add diluted fabric softener (on models with a fabric softener dispenser)
2. Add clothes
3. Select load size and other wash options
 - Select wash cycle
4. Close lid
 - Push **START**

Quick Start Guide

NOTE: When making a selection with any knob, simply point the knob anywhere within the shaded range for that setting.

Model S4200

| LOAD SIZE | SPEEDS | TEMPERATURE | OPTIONS |
|-----------|--------|-------------|---------|
| | | | |

Model WASE5210

| LOAD SIZE | SPEEDS | TEMPERATURE | OPTIONS |
|-----------|--------|-------------|---------|
| | | | |

Model WBSE3120

| LOAD SIZE | TEMPERATURE |
|-----------|-------------|
| | |

Model WCSE4160



Model WHDSE820



Model WJSE4150



Model WLE4000



About the washer control panel.

Model WSSE5210

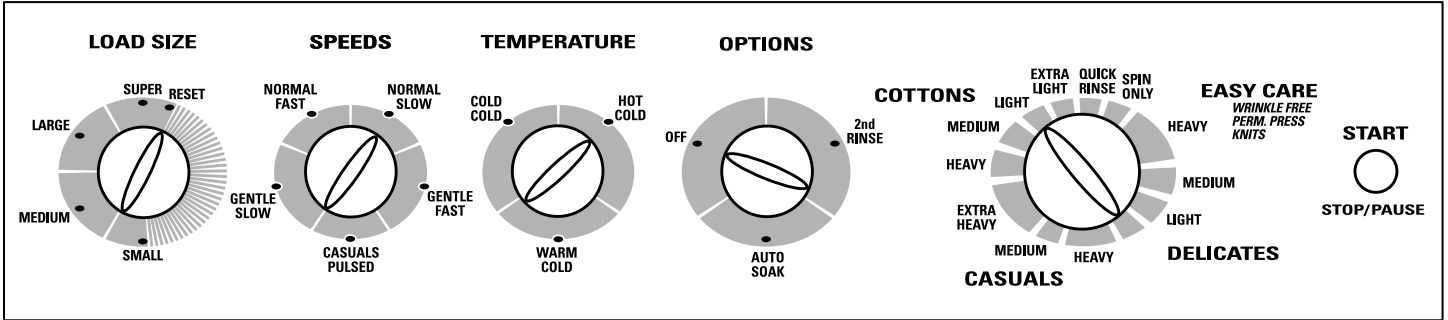

Model WWSE5200

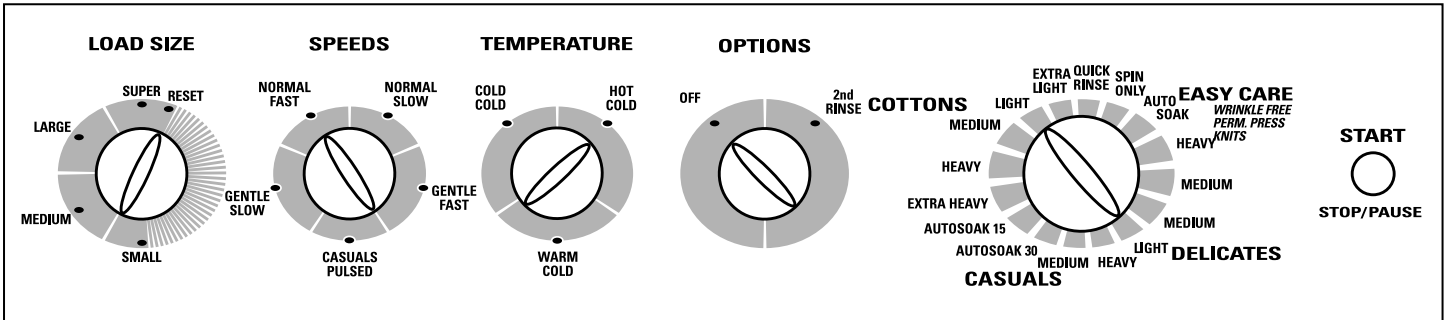

Color Logic (on some models)

Select the correct **TEMPERATURE** setting. Match the particular color below the words with the same color on the **WASH/SPIN SPEED** setting. Next, match the color again with the same color on the Cycle Selector knob.

Example: Washing a load of medium-soiled cotton towels and sheets.

- 1 Choose the **LOAD SIZE**.
- 2 Choose the **TEMPERATURE** setting—for this load it would be the **HOT COLD** (which is a particular color).
- 3 On some models, choose the **WASH/SPIN SPEED** setting that matches that color—for this load it would be the **NORMAL FAST**.
- 4 Turn the Cycle Selector knob to the area that has the same color as the **TEMPERATURE** and **WASH/SPIN SPEED** settings you have chosen—for this load it would be the **COTTONS** area. Turn the knob to the **MEDIUM** setting.



Load Size

Loosely load clothes no higher than the top row of holes in the washer basket. The water level should just cover the clothes. Adjust the load size accordingly.



Custom Care Wash/Spin Speeds

The agitator moves clothes around for a cleaner wash; the basket spins later in the cycle to release water from the load. On some models, the Wash/Spin Speed dial sets the speed of both the agitator and the basket. On some models, the Wash/Spin speed settings are located on the Cycle Selector knob.

Wash Speeds

With Normal Speed, the agitator will move at a high speed for the first few minutes, then it slows down to a moderate speed. This gets your clothes clean while reducing wear on your clothing. Use for cottons, denims and play clothes.

With Gentle Speed, the agitator moves slower. Use for delicate and knit items.

With Casuals, the agitator will agitate and then pause to soak your clothes. It provides a gentler way to wash your wrinkle-free and permanent press items and knits.

Spin Speeds

The Fast spin speed is for normal items. Use it to remove more water from your clothes to allow them to dry faster in the dryer.

The Slow spin speed is for delicate items like sweaters and lingerie. When using Slow spin speed, clothes will be less dry than when using Fast spin speed.

About the control settings.



Temperature

Select the water temperature for the wash and rinse cycles. Always follow fabric manufacturer's care label or instructions when laundering.



Wash Cycle

The wash cycle controls the length of the washing process. The knob can be turned in either direction. Turning the Cycle Selector knob after starting a cycle will stop the washer and reset the cycle to the new selection. Press **START** to begin the new cycle selection.

REMEMBER: When choosing the cycle, the Cycle Selector knob can be pointed anywhere within the shaded range for the cycle setting.



The Cycle Indicator Lights show what stage the washer is in. The wash time is the length of the wash agitation. The **6 MIN** light will remain lit during drain and spin. When the Selector knob is set to a new cycle, the Indicator Lights will flash momentarily, showing what stages the cycle will go through.

On models without an Auto Soak option, the **SOAK** light will not light up.

The chart below will help you match the wash cycle setting with your clothing.

COTTONS/ WHITES For heavily to lightly soiled cottons, household linens, work and play clothes.

EASY CARE/ COLORS For wrinkle-free and permanent press items, and knits.

DARK COLORS For noncolorfast items and blends.

CASUALS For wrinkle-free and permanent press items, and knits.
The **HEAVY** cycle has three agitate/pause cycles to clean your heavily soiled items.
The **MEDIUM** cycle has two agitate/pause cycles.

DELICATES For lingerie and special-care fabrics with light to normal soil.

QUICK RINSE For quickly rinsing chlorine, perspiration, stains, etc., out of clothes.

15 MIN/30 MIN AUTO SOAK For heavily soiled clothes. Begins with a brief agitation, soaks for a specified period of time, then moves through the rest of the cycle automatically.

2nd RINSE Provides an additional cold rinse.



START

Press **START** to begin the cycle. Pressing **START** again or raising the lid will **PAUSE** the cycle and the Cycle indicator light will blink.

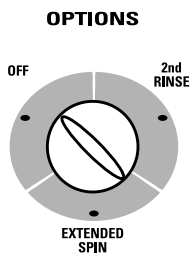

(appearance and features may vary)

2nd Rinse Option (on some models)

When you use extra detergent or bleach to clean heavily soiled clothes, you may want to use the 2nd Rinse option. It provides a second deep cold rinse.

Extended Spin Option (on some models)

Use this option to extract more water from your clothes. Clothes will be drier when this option is selected and will dry more quickly in your dryer.

Auto Soak (on some models)

This option adds a short agitation and soaking period at the beginning of the selected wash cycle.

AutoTemp

AutoTemp (on some models)

AutoTemp senses the incoming water temperature and adjusts the cold water temperature to ensure that the incoming cold water is warm enough to dissolve the detergent. Often, detergents are not completely dissolved in very cold water, especially in cooler climates.



Liquid Bleach Dispenser

The dispenser dilutes liquid chlorine bleach before it reaches into your wash load.

- 1 Check clothing care labels for special instructions.
- 2 Measure liquid bleach carefully, following instructions on the bottle.
 - Never pour undiluted liquid chlorine bleach directly onto clothes or into the wash basket.
 - Do not pour powdered bleach into bleach dispenser.
- 3 Before starting the washer, pour measured amount of bleach directly into bleach dispenser. Avoid splashing or overfilling dispenser. If you prefer to use powdered bleach, add it into the wash basket with your detergent.
 - Do not mix chlorine bleach with ammonia or acids such as vinegar and/or rust remover. Mixing can produce a toxic gas which may cause death.



Separate for cleaning.

Cleaning the Fabric Softener Dispenser

- 1 Remove the dispenser from the top of the agitator.
- 2 Separate the dispenser cup from the cover by grasping the top and pushing down on the inside of the cup with your fingers. Dispenser cup will pop free from the cover.
- 3 To clean the dispenser, soak both the dispenser cup and the dispenser cover in the following solution:
 - 1 US gallon (3.8 liters) warm water
 - 1/4 cup (60 ml) heavy-duty liquid detergent
 - 1 cup (240 ml) bleach
- 4 If necessary, loosen buildup with a clean, soft cloth after soaking. Do not use a stiff brush; you may roughen the surface of the dispenser.
- 5 Rinse and reassemble dispenser. Place dispenser back on the agitator.

About washer features.

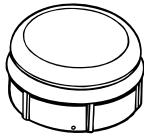

The Agitator Cap or Fabric Softener Dispenser (depending on model)

The agitator cap fits into the top of the agitator. If it accidentally comes off, simply put it back on.

The fabric softener dispenser automatically releases liquid fabric softener at the proper time during the cycle.

Do not stop the washer during the first spin. This will cause the dispenser to empty too soon.

To use, follow these steps:

- 1 Make sure dispenser is securely attached to agitator.
- 2 Use only liquid fabric softener. Pour into dispenser, using amount recommended on package.

Never pour fabric softener directly on clothes. It may stain them.

- 3 Add water to dispenser until it reaches the maximum fill line.

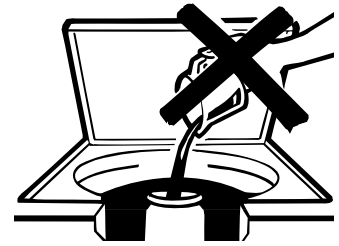

Do not pour anything into the agitator if the agitator cap or dispenser is removed.

Loading and using the washer. Always follow fabric manufacturer's care label when laundering.



Sorting Wash Loads

Sort by color (whites, lights, colors), soil level, fabric type (sturdy cottons, easy-care, delicates), and whether the fabric produces lint (terry cloth, chenille), or collects lint (velveteen, corduroy).

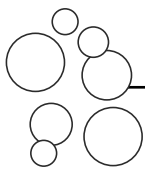

Proper Use of Detergent

Add detergent and start the washer before adding clothes so that the detergent can work effectively. Using too little or too much detergent is a common cause of laundry problems.

You can use less detergent if you have soft water, a smaller load or a lightly soiled load.



Loading the Washer

Load dry items loosely, no higher than the top row of holes in the washer basket. When loading wet items, make sure you set the load/water level high enough to allow the items to move freely. Water level should just cover the clothes. To add items after washer has started, lift the lid and submerge additional items next to the agitator.

- Do not wrap long items like sheets or pants around the agitator.
- Do not wash fabrics containing flammable materials (waxes, cleaning fluids, etc.).
- Agitation will not start with the lid up.



Care and Cleaning of the Washer

Wash Basket: Leave the lid open after washing to allow moisture to evaporate. If you want to clean the basket, use a clean soft cloth dampened with liquid detergent, then rinse. (Do not use harsh or gritty cleaners.)

Fill Hoses: Hoses connecting washer to faucet should be replaced every 5 years.

Lint Filter: The lint filter is located under the agitator. It is self-cleaning and requires no maintenance.

Exterior: Immediately wipe off any spills. Wipe with damp cloth. Try not to hit surface with sharp objects.

Moving and Storage: Ask the service technician to remove water from drain pump and hoses. See the Installation Instructions packed with product for information on how to reinstall the shipping rod to keep the tub stationary when moving the washer. For more information, visit GEAppliances.com, or call **800.GE.CARES** (800.432.2737). Do not store the washer where it will be exposed to the weather.

Long Vacations: Be sure water supply is shut off at faucets. Drain all water from hoses if weather will be below freezing.



Fabric Care Labels

Below are fabric care label “symbols” that affect the clothing you will be laundering.

WASH LABELS

| | | | | | | |
|---------------------------|--|--|--|--|--|--|
| Machine wash cycle | | | | | | |
| Water temperature | | | | | | |

DRY LABELS

| | | | | | | |
|-----------------------------|--|--|--|--|--|--|
| Tumble dry | | | | | | |
| Heat setting | | | | | | |
| Special instructions | | | | | | |

BLEACH LABELS

| | | | |
|-----------------------|--|--|--|
| Bleach symbols | | | |
|-----------------------|--|--|--|

Before you call for service...



Troubleshooting Tips

Save time and money! Review the charts on the following pages, or visit www.GEAppliances.com. You may not need to call for service.

| AUTOTEMP | Possible Causes | What To Do |
|---|---|--|
| AutoTemp cold wash temperature is incorrect | The washer is in a cold rinse cycle | <ul style="list-style-type: none"> This is normal. The AutoTemp feature is designed not to activate during a cold rinse cycle so that the coldest water available is used. |
| (Review AutoTemp in the About washer features section) | All the water in the water heater has been used | <ul style="list-style-type: none"> Wait until the water in the water heater is heated to the correct temperature. |
| WATER | Possible Causes | What To Do |
| Too many suds | Type of detergent | <ul style="list-style-type: none"> Switch to a lower sudsing detergent brand and follow instructions on package. |
| | Very soft water | <ul style="list-style-type: none"> Try less detergent. |
| | Too much detergent | <ul style="list-style-type: none"> Measure your detergent carefully. Use less soap if you have soft water, a smaller load, or a lightly soiled load. |
| Water leaks | Fill hoses or drain hose is improperly connected | <ul style="list-style-type: none"> Make sure hose connections are tight at faucets and rubber washers are installed. Make sure end of drain hose is correctly inserted in and secured to drain facility. |
| | Household drain may be clogged | <ul style="list-style-type: none"> Check household plumbing. You may need to call a plumber. |
| | Constant water pressure to the fill hoses at the water source | <ul style="list-style-type: none"> Tighten hoses at the faucets and turn the water off after each use. Check condition of the fill hoses; they should be replaced every 5 years. |
| | Using too much detergent in washer | <ul style="list-style-type: none"> Use less detergent. Use less soap if you have soft water, a smaller load, or a lightly soiled load. |
| Water temperature is incorrect | Control is not set properly | <ul style="list-style-type: none"> Check water temperature control and adjust. |
| | Water supply is turned off or improperly connected | <ul style="list-style-type: none"> Turn both hot and cold faucets fully on and make sure hoses are connected to correct faucets. |
| | Water valve screens are stopped up | <ul style="list-style-type: none"> Turn off the water source and remove the water connection hoses from the upper back of the washer. Use a brush or toothpick to clean the screens in the machine. Reconnect the hoses and turn the water back on. |
| | House water heater is not set properly | <ul style="list-style-type: none"> Make sure house water heater is delivering water at 120°–140°F (48°–60°C). |
| Water pumped out before cycle is complete | Lid lifted or cycle was put in pause for over 24 hours | <ul style="list-style-type: none"> Reset cycle. |
| Water won't drain | Drain hose is kinked or improperly connected | <ul style="list-style-type: none"> Straighten drain hose and make sure washer is not sitting on it. Top of drain outlet should be less than 8 ft. (2.5 m) above floor. |

| OPERATION | Possible Causes | What To Do | |
|-----------------------------------|---|--|---|
| Washer pauses in cycle | The DELICATES or CASUALS cycle was chosen | <ul style="list-style-type: none"> This is normal. The washer alternates between agitate and soak during the DELICATES and CASUALS cycles to get your clothes cleaner with less wear. | |
| Washer won't operate | Washer is unplugged | <ul style="list-style-type: none"> Make sure cord is plugged securely into a working outlet. | |
| | Water supply is turned off | <ul style="list-style-type: none"> Turn both hot and cold faucets fully on. | |
| | Controls are not set properly | <ul style="list-style-type: none"> Check controls. | |
| | Lid is open—safety feature prevents agitation and spinning when lid is up | <ul style="list-style-type: none"> Close lid and reset cycle, to the beginning if necessary. | |
| | Circuit breaker/fuse is tripped/blown | <ul style="list-style-type: none"> Check house circuit breakers/fuses. Replace fuses or reset breaker. Washer should have separate outlet. | |
| | Electronics need to be reset | <ul style="list-style-type: none"> Unplug washer, wait 2 minutes, plug back in, and press START. | |
| | START was not pressed | <ul style="list-style-type: none"> Press START. | |
| PERFORMANCE | Possible Causes | What To Do | |
| Clothes too wet | Incorrect spin cycle selected | <ul style="list-style-type: none"> Make sure the spin cycle selected matches the load you are washing. Some fabrics will feel wetter when rinsed with cold water. | |
| Colored spots | Incorrect use of fabric softener | <ul style="list-style-type: none"> Check fabric softener package for instructions and follow directions for using dispenser. Pretreat stain and rewash. | |
| | Dye transfer | <ul style="list-style-type: none"> Sort whites or lightly colored items from dark colors. | |
| Grayed or yellowed clothes | Not enough detergent | <ul style="list-style-type: none"> Use more detergent (especially with larger loads). | |
| | Hard water | <ul style="list-style-type: none"> Use a water conditioner like Calgon brand or install a water softener. | |
| | Water is not hot enough | <ul style="list-style-type: none"> Make sure water heater is delivering water at 120°–140°F (48°–60°C). | |
| | Washer is overloaded | <ul style="list-style-type: none"> Select load size to match clothes load. | |
| | Detergent is not dissolving | <ul style="list-style-type: none"> Add detergent as wash basket fills with water before you load clothes. | |
| | Dye transfer | <ul style="list-style-type: none"> Sort clothes by color. If fabric label states <i>wash separately</i>, unstable dyes may be indicated. | |
| Lint or residue on clothes | Clothes are air or line dried | <ul style="list-style-type: none"> If you do not dry your clothes with a clothes dryer, your clothes may retain more lint. | |
| | Incorrect sorting | <ul style="list-style-type: none"> Separate lint producers from lint collectors. | |
| | Washing too long | <ul style="list-style-type: none"> Wash small loads for a shorter time than larger loads. | |
| | Detergent not dissolving | | <ul style="list-style-type: none"> Add detergent as wash basket fills with water, before you load clothes. Try a liquid detergent. Use warmer water temperature. |
| | | Overloading | <ul style="list-style-type: none"> Load clothes no higher than the top row of holes in the washer basket. Make sure load size selector matches clothes load size. |
| | | Incorrect use of fabric softener | <ul style="list-style-type: none"> Check fabric softener package for instructions and follow directions for using dispenser. |

Before you call for service...

| <i>PERFORMANCE (cont.)</i> | <i>Possible Causes</i> | <i>What To Do</i> |
|---|---|--|
| Pilling | Result of normal wear on poly-cotton blends and fuzzy fabrics | <ul style="list-style-type: none"> • While this is not caused by the washer, you can slow the pilling process by washing garments inside out. |
| Snags, holes, tears, rips or excessive wear | Pins, snaps, hooks, sharp buttons, belt buckles, zippers, and sharp objects left in pockets | <ul style="list-style-type: none"> • Fasten snaps, hooks, buttons, and zippers. • Remove loose items like pins, objects in pockets and sharp buttons. • Turn knits (which snag easily) inside out. |
| | Undiluted chlorine bleach | <ul style="list-style-type: none"> • Check bleach package instructions for proper amount. • Never add undiluted bleach to wash or allow clothes to come in contact with undiluted bleach. |
| | Chemicals like hair bleach or dye, permanent wave solution | <ul style="list-style-type: none"> • Rinse items that may have chemicals on them before washing. |
| Wrinkling | Improper sorting | <ul style="list-style-type: none"> • Avoid mixing heavy items (like work clothes) with light items (like blouses). • Try a fabric softener. |
| | Overloading or incorrect water level | <ul style="list-style-type: none"> • Load your washer so clothes have enough room to move freely. |
| | Incorrect wash and dry cycles | <ul style="list-style-type: none"> • Match Cycle selection to the type of fabric you are washing (especially for easy-care loads). |
| | Repeated washing in water that is too hot | <ul style="list-style-type: none"> • Wash in warm or cold water. |
| NOISE | <i>Possible Causes</i> | <i>What To Do</i> |
| Washer is noisy | Washer is uneven | <ul style="list-style-type: none"> • To level the front of the washer, adjust the front leveling legs by rotating the individual leg in the proper direction for up or down. To level back of washer, lift back of machine 4" (10 cm) and set down. |
| | Washer load is unbalanced | <ul style="list-style-type: none"> • Press PAUSE to stop the washer, open the lid and redistribute the load evenly. Close the lid and press START. |
| | Shipping rod is still assembled in unit | <ul style="list-style-type: none"> • To remove shipping rod from washer, pull yellow tag and attached rod from the bottom right-hand side of washer. |
| | Washer is sitting too close to wall (causes knocking during cycle) | <ul style="list-style-type: none"> • Pull washer away from the wall; about 4" (10 cm) is needed. |
| OTHER | <i>Possible Causes</i> | <i>What To Do</i> |
| Labels on the exterior of the washer will not peel off cleanly | Occasionally the adhesive used on the labels does not release cleanly | <ul style="list-style-type: none"> • Use a hair dryer set at the lowest heat setting, directing the air at the label for a short amount of time. This will release the adhesive easily, without damaging the surface of the washer. |

GE Washer Warranty. (For customers in the United States)



All warranty service provided by our Factory Service Centers, or an authorized Customer Care[®] technician. To schedule service, on-line, 24 hours a day, visit us at GEAppliances.com, or call 800.GE.CARES (800.432.2737).

Staple your receipt here.
Proof of the original purchase date is needed to obtain service under the warranty.

For The Period Of: We Will Replace:

| | |
|--|---|
| One Year From the date of the original purchase | Any part of the washer which fails due to a defect in materials or workmanship. During this full one-year warranty , GE will also provide, free of charge , all labor and related service costs to replace the defective part. |
| Second through Fifth Year From the date of the original purchase | The transmission, suspension rod and spring assembly , if any of these parts should fail due to a defect in materials or workmanship. GE will also replace the washer lid or cover , if they should rust under operating conditions. During this additional four-year limited warranty , you will be responsible for any labor or related service costs. |
| Second through Tenth Year From the date of the original purchase | The washer tub , if it should fail due to a defect in materials or workmanship. During this additional nine-year limited warranty , you will be responsible for any labor or related service costs. |
| Second through Twentieth Year From the date of the original purchase | The washer basket , if it should fail due to a defect in materials or workmanship. During this additional nineteen-year limited warranty , you will be responsible for any labor or related service costs. |

What Is Not Covered:

- Service trips to your home to teach you how to use the product.
- Improper installation.
- Failure of the product if it is abused, misused, or used for other than the intended purpose or used commercially.
- Replacement of house fuses or resetting of circuit breakers.
- Damage to the product caused by accident, fire, floods or acts of God.
- Incidental or consequential damage caused by possible defects with this appliance.

This warranty is extended to the original purchaser and any succeeding owner for products purchased for home use within the USA. In Alaska, the warranty excludes the cost of shipping or service calls to your home.

Some states do not allow the exclusion or limitation of incidental or consequential damages. This warranty gives you specific legal rights, and you may also have other rights which vary from state to state. To know what your legal rights are, consult your local or state consumer affairs office or your state's Attorney General.

Warrantor: General Electric Company, Louisville, KY 40225

Consumer Support.



GE Appliances Website

GEAppliances.com

Have a question or need assistance with your appliance? Try the GE Appliances Website 24 hours a day, any day of the year! For greater convenience and faster service, you can now download Owner's Manuals, order parts, catalogs, or even schedule service on-line. You can also "Ask Our Team of Experts™" your questions, and so much more...



Schedule Service

GEAppliances.com

Expert GE repair service is only one step away from your door. Get on-line and schedule your service at your convenience 24 hours any day of the year! Or call 800.GE.CARES (800.432.2737) during normal business hours.



Real Life Design Studio

GEAppliances.com

GE supports the Universal Design concept—products, services and environments that can be used by people of all ages, sizes and capabilities. We recognize the need to design for a wide range of physical and mental abilities and impairments. For details of GE's Universal Design applications, including kitchen design ideas for people with disabilities, check out our Website today. For the hearing impaired, please call 800.TDD.GEAC (800.833.4322).



Extended Warranties

GEAppliances.com

Purchase a GE extended warranty and learn about special discounts that are available while your warranty is still in effect. You can purchase it on-line anytime, or call 800.626.2224 during normal business hours. GE Consumer Home Services will still be there after your warranty expires.



Parts and Accessories

GEAppliances.com

Individuals qualified to service their own appliances can have parts or accessories sent directly to their homes (VISA, MasterCard and Discover cards are accepted). Order on-line today, 24 hours every day or by phone at 800.626.2002 during normal business hours.

Instructions contained in this manual cover procedures to be performed by any user. Other servicing generally should be referred to qualified service personnel. Caution must be exercised, since improper servicing may cause unsafe operation.



Contact Us

GEAppliances.com

If you are not satisfied with the service you receive from GE, contact us on our Website with all the details including your phone number, or write to: General Manager, Customer Relations
GE Appliances, Appliance Park
Louisville, KY 40225



Register Your Appliance

GEAppliances.com

Register your new appliance on-line—at your convenience! Timely product registration will allow for enhanced communication and prompt service under the terms of your warranty, should the need arise. You may also mail in the preprinted registration card included in the packing material.