

This Owner's Manual is provided and hosted by [Appliance Factory Parts](http://ApplianceFactoryParts.com).

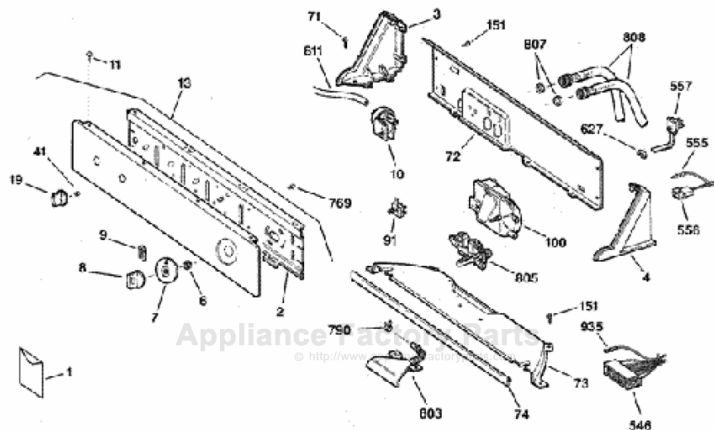

# GE WHSR2070V2WB Owner's Manual

[Shop genuine replacement parts for GE  
WHSR2070V2WB](#)



[Find Your GE Washer Parts - Select From 4591 Models](#)

----- Manual continues below -----



**GE Appliances**

# Washers



## **Owner's Manual**

S2200	WJSR2080
S3200	WMSR2100
WBSR1060	WNSR2100
WBXR1060	WNXR2100
WBXR2060	WSSR2070
WCSR2070	WWSR3130
WCXR1070	WWSR4140
WHSR2070	



**GE Answer Center® 800.626.2000**

**Part No. 175D1807P268** Pub. No. 49-9999 2-99 CG

<b>Safety Instructions</b>	<b>Safety Information</b> .....3
<b>Operating Instructions</b>	<b>Operating Instructions</b> Control Panels and settings ..... 4-7 Features .....8, 9 Loading and Using the Washer ...10, 11
<b>Troubleshooting Tips</b>	<b>Troubleshooting Tips</b> Before You Call For Service .....12-14
<b>Customer Service</b>	<b>Customer Service</b> Warranty .....15 Service Telephone Numbers .....Back Cover

# Congratulations! You Are Now Part of the GE Family.

Welcome to the GE family. We're proud of our quality products and we are committed to providing dependable service. You'll see it in this easy-to-use Owner's Manual and you'll hear it in the friendly voices of our customer service department.

Best of all, you'll experience these values each time you use your washer. That's important, because your new washer will be part of your family for many years. And we hope you will be part of ours for a long time to come.

We thank you for buying GE. We appreciate your purchase, and hope you will continue to rely on us whenever you need quality appliances for your home.

## A Service Partnership.



### IMPORTANT!

**Staple sales slip or cancelled check here.**

Proof of the original purchase date is needed to obtain service under the warranty.



### FOR YOUR RECORDS

**Write the model and serial numbers here:**

# \_\_\_\_\_

# \_\_\_\_\_

You can find them in the upper right corner on the back of your washer.

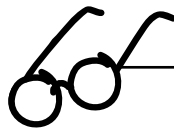

### READ THIS MANUAL

Inside you will find many helpful hints on how to use and maintain your washer properly. Just a little preventive care on your part can save you a great deal of time and money over the life of your washer.

You'll find many answers to common problems in the *Before You Call For Service* section. If you review our chart of *Troubleshooting Tips* first, you may not need to call for service at all.



### IF YOU NEED SERVICE

If you do need service, you can relax knowing help is only a phone call away. A list of toll-free customer service numbers is included in the back section. Or you can always call the GE Answer Center® at 800.626.2000, 24 hours a day, 7 days a week.

# IMPORTANT SAFETY INFORMATION. READ ALL INSTRUCTIONS BEFORE USING.

**⚠ WARNING!** For your safety, the information in this manual must be followed to minimize the risk of fire or explosion, electric shock, or to prevent property damage, personal injury, or loss of life.



## WATER HEATER SAFETY

Under certain conditions hydrogen gas may be produced in a water heater that has not been used for two weeks or more. Hydrogen gas can be explosive under these circumstances.

If the hot water has not been used for two weeks or more, prevent the possibility of damage or injury by turning on all hot water faucets and allowing them to run for several minutes. Do this before using any electrical appliance which is connected to the hot water system. This simple procedure will allow any built-up hydrogen gas to escape. Since the gas is flammable, do not smoke or use an open flame or appliance during this process.



## PROPER INSTALLATION

This washer must be properly installed and located in accordance with the Installation Instructions before it is used. If you did not receive an Installation Instructions sheet, you can receive one by calling us toll-free at the GE Answer Center®, 800.626.2000.

- Install or store where it will not be exposed to temperatures below freezing or exposed to the weather.
- Properly ground washer to conform with all governing codes and ordinances. Follow details in Installation Instructions.



## YOUR LAUNDRY AREA

■ Keep the area underneath and around your appliances free of combustible materials such as lint, paper, rags, chemicals, etc.

■ Close supervision is necessary if this appliance is used by or near children. Do not allow children to play on, with, or inside this or any other appliance.



## WHEN USING THE WASHER USE

■ Never reach into washer while it is moving. Wait until the machine has completely stopped before opening the lid.

■ Do not mix chlorine bleach with ammonia or acids such as vinegar and/or rust remover. Mixing different chemicals can produce a toxic gas which may cause death.

■ Do not wash or dry articles that have been cleaned in, washed in, soaked in, or spotted with combustible or explosive substances (such as wax, oil, paint, gasoline, degreasers, dry-cleaning solvents, kerosene, etc.) which may ignite or explode. Do not add these substances to the wash water. Do not use or place these substances around your washer or dryer during operation.

■ The laundry process can reduce the flame retardancy of fabrics. To avoid such a result, carefully follow the garment manufacturer's wash and care instructions.

■ To minimize the possibility of electric shock, unplug this appliance from the power supply or disconnect the washer at the household distribution panel by removing the fuse or switching off the circuit breaker before attempting any maintenance or cleaning. **NOTE:** Turning the Cycle Selector knob to an off position does **NOT** disconnect the appliance from the power supply.

■ Never attempt to operate this appliance if it is damaged, malfunctioning, partially disassembled, or has missing or broken parts, including a damaged cord or plug.

Use this appliance only for its intended purpose as described in this Owner's Manual.



## WHEN NOT IN USE

■ Turn off water faucets to relieve pressure on hoses and valves and to minimize leakage if a break or rupture should occur. Check the condition of the fill hoses; they may need replacement after 5 years.

■ Before discarding a washer, or removing it from service, remove the washer lid to prevent children from hiding inside.

■ Do not attempt to repair or replace any part of this appliance unless specifically recommended in this Owner's Manual, or in published user-repair instructions that you understand and have the skills to carry out.

■ Do not tamper with controls.



Read and follow this Safety Information carefully.

**SAVE THESE INSTRUCTIONS**

# About the washer control panel. Look on your washer for the controls below that apply to your model.

These pages cover models **WBSR1060, WBXR1060, WBXR2060, WCSR2070, WCXR1070, WHSR2070, WJSR2080, WMSR2100, WNSR2100, WNXR2100 and WSSR2070.**

## 1 Load Size

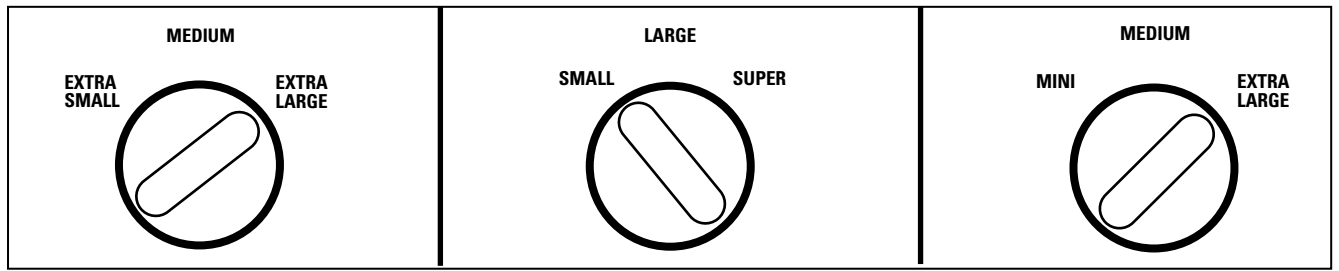

## 2 Temperature

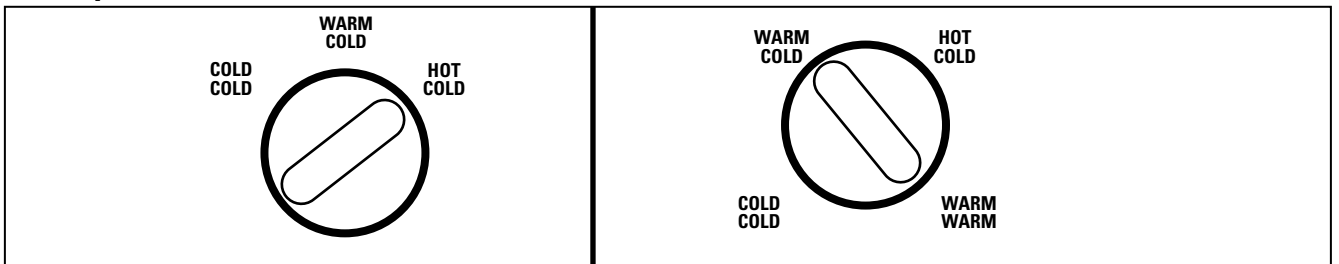

## 3 Wash Cycle

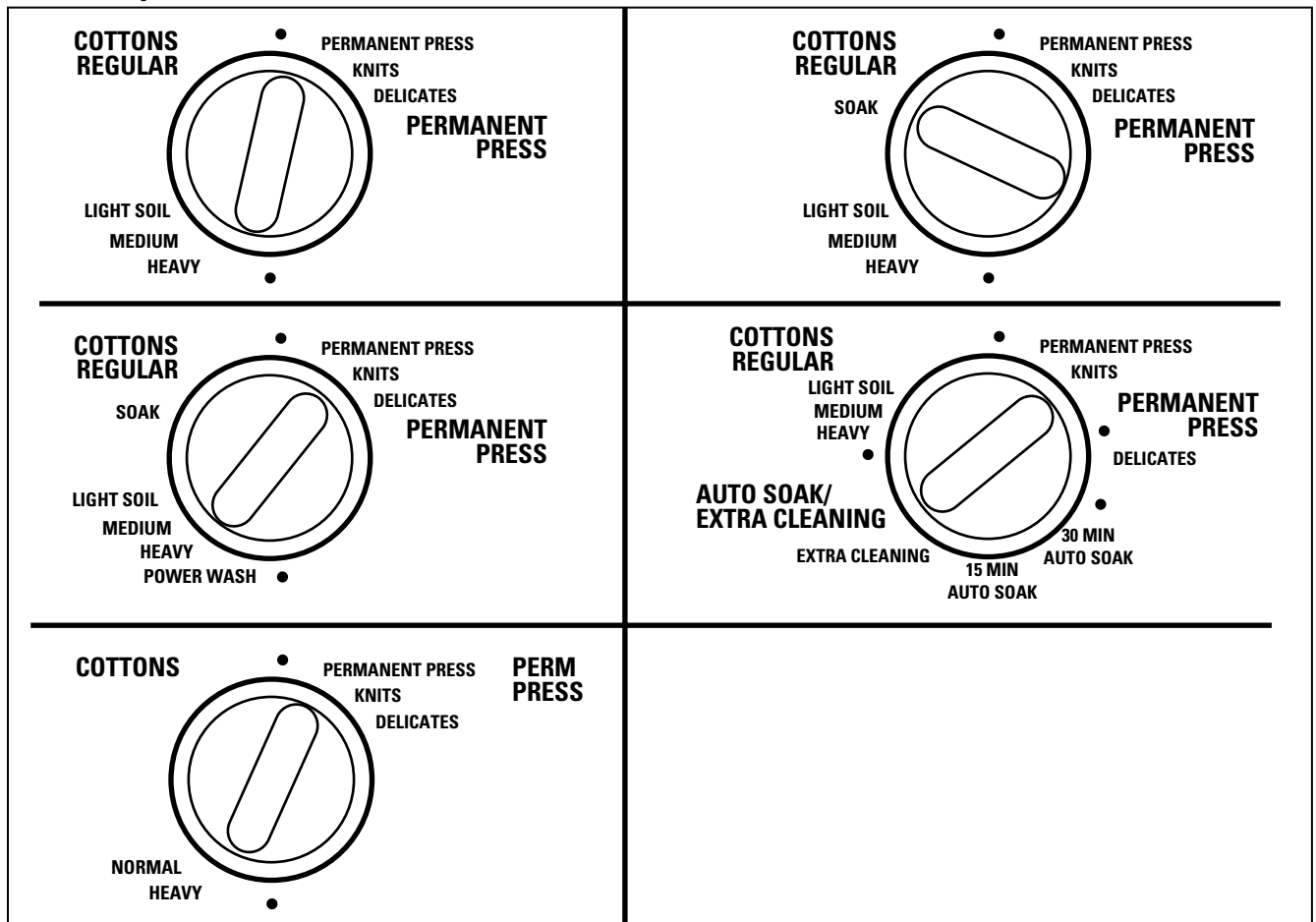



## Control Settings

### 1 Load Size

The water level should just cover the clothes. Adjust the load size accordingly. Loosely load clothes no higher than the top row of holes in the washer tub.

### 2 Temperature

Select the water temperature for the wash and rinse cycles. Always follow fabric manufacturer's care label or instructions when laundering. Follow the water temperature guide on the washer lid.

### 3 Wash Cycle

The wash cycle controls the length of the washing process. The chart below will help you match the wash cycle setting with your clothing.

**COTTONS REGULAR** For heavy to lightly soiled cottons, household linens, work and play clothes.

**PERMANENT PRESS** For easy care and wrinkle-resistant items.

**KNITS** Specially designed for normally soiled knits.

**DELICATES** For lingerie and delicate fabrics with light to normal soil.

**SOAK** For heavily soiled clothes that need to be soaked before washing. Once the soak and spin cycle is complete reset the control to a wash setting.

**POWER WASH** For heavily soiled and heavy-duty fabrics. This cycle provides a longer agitation.

**AUTO SOAK** For heavily soiled clothes. Begins with a brief agitation, soaks for a specified period of time, then moves through the rest of the cycle automatically.

**EXTRA CLEANING** Provides a timed auto soak, extra rinse and extra spin for heavily soiled clothes.

# About the washer control panel.

Look on your washer for the controls below that apply to your model.  
 These pages cover models S2200, S3200, WWSR3130 and WWSR4140.

## 1 Load Size

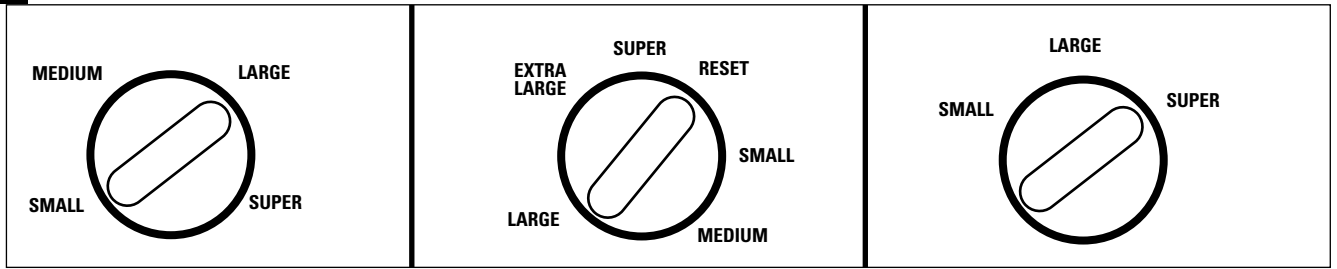

## 2 Wash/Spin Speed

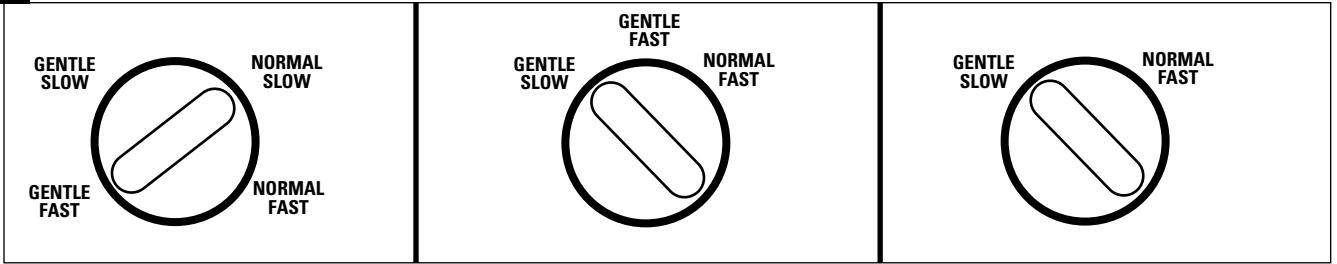

## 3 Temperature

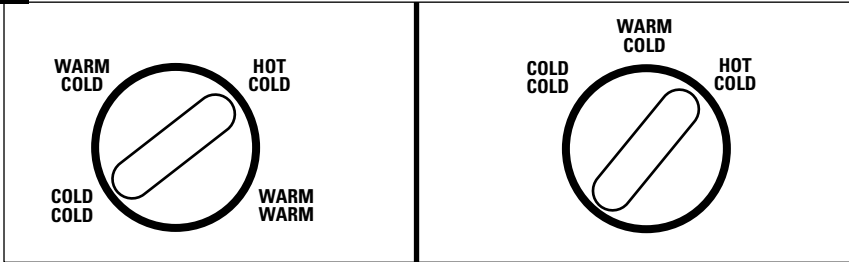

## 4 Wash Cycle

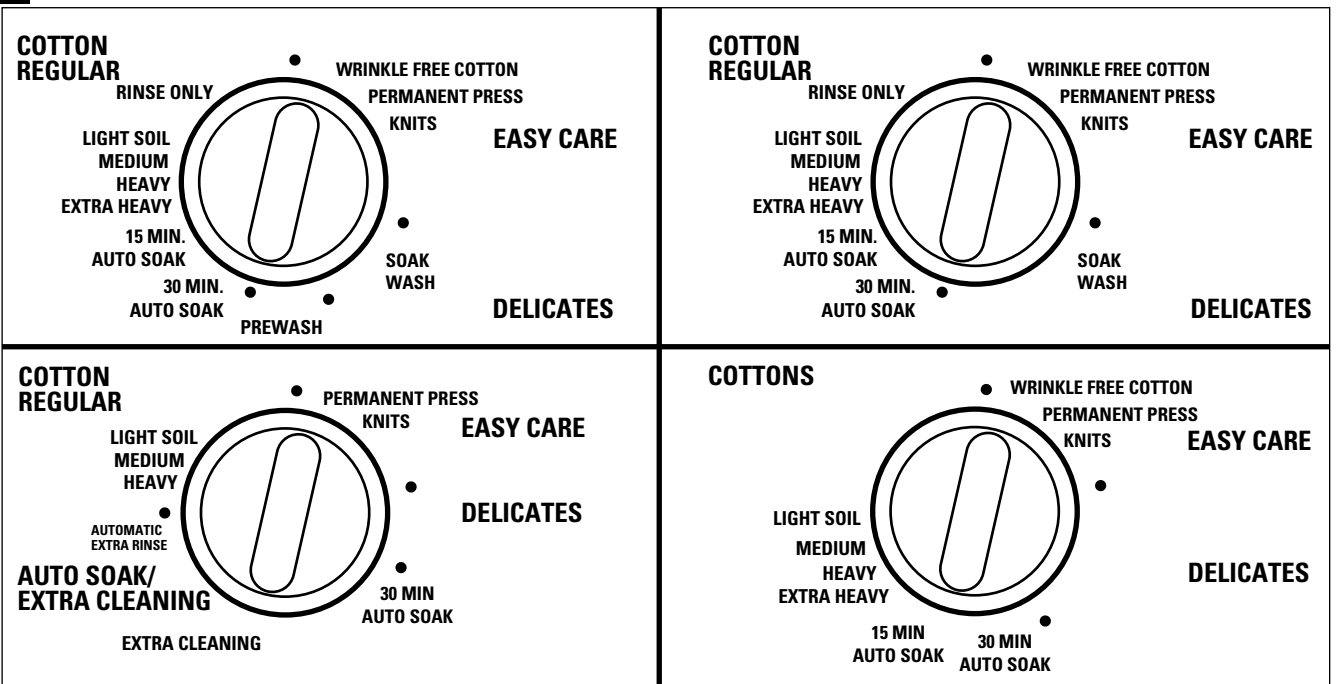



## Control Settings

### 1 Load Size

The water level should just cover the clothes. Adjust the load size accordingly. Loosely load clothes no higher than the top row of holes in the washer tub.

### 2 Wash/Spin Speed

The agitator moves clothes around for a cleaner wash; the basket spins later in the cycle to release water from the load. The Wash/Spin Speed dial sets the speed of both the agitator and the basket.

With Normal wash speed, the agitator moves faster. Use for cottons, denims and play clothes. With Gentle wash speed, the agitator moves slower. Use for delicate and knit items.

The Fast spin speed is for durable items. The Slow spin speed is for delicate items like sweaters and lingerie. When using the Slow spin speed, clothes will be less dry than when using Fast spin speed.

### 3 Temperature

Select the water temperature for the wash and rinse cycles. Always follow fabric manufacturer's care label or instructions when laundering. Follow the water temperature guide on the washer lid.

### 4 Wash Cycle

The wash cycle controls the length of the washing process. The chart below will help you match the wash cycle setting with your clothing.

**COTTONS  
REGULAR** For heavy to lightly soiled cottons, household linens, work and play clothes.

**EASY CARE** For easy care and wrinkle-resistant items.

**KNITS** Specially designed for normally soiled knits.

**DELICATES** For lingerie and delicate fabrics with light to normal soil.

**EXTRA HEAVY/  
HEAVY** For heavily soiled and heavy-duty fabrics. This cycle provides a longer agitation.

**PREWASH** For heavily soiled clothes or for clothes with a care label that recommends prewashing before wearing.

**AUTO SOAK/  
EXTRA CLEANING** For heavily soiled clothes. Begins with a brief agitation, soaks for a specified period of time, then moves through the rest of the cycle automatically.

## About washer features. *NOTE: Not all features are available on all washer models.*



### Liquid Bleach Dispenser (on some models)

The dispenser dilutes liquid chlorine bleach before it reaches into your wash load.

- 1 Check clothing care labels for special instructions.
- 2 Measure liquid bleach carefully, following instructions on the bottle.
  - Never pour undiluted liquid chlorine bleach directly onto clothes or into the wash basket.
  - Do not pour powdered bleach into bleach dispenser.
- 3 Before starting the washer, pour measured amount of bleach directly into bleach dispenser. Avoid splashing or over-filling dispenser. If you prefer to use powdered bleach, add it into the wash basket with your detergent.
  - Do not mix chlorine bleach with ammonia or acids such as vinegar and/or rust remover. Mixing can produce a toxic gas which may cause death.

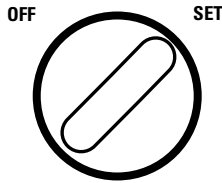

### Extra Rinse (on some models)

When you use extra detergent or bleach to clean heavily soiled clothes, you may want to use the Extra Rinse option. This option provides a second deep cold rinse in the **COTTONS** cycle. Turn the Extra Rinse knob to **SET**.

*The washer will pause for a few minutes before the Extra Rinse option begins.*

### SensorWash

### SensorWash (on some models)

The **SensorWash** senses the incoming water temperature and adjusts the fill water to obtain a more precise temperature range for all three wash temperatures. You may select cold, warm or hot. For example, in a Cold Wash selection, some warm water may be added to reach a temperature needed to better dissolve detergents. *Often, detergents are not completely dissolved in very cold water, especially in cooler climates.*

**NOTE:** The **SensorWash** will not adjust the fill on **WARM WASH** unless the washer lid is closed. **Be sure to start the washer after the lid is closed.**



### The Agitator Cap or Fabric Softener Dispenser (depending on model)

The **agitator cap** fits into the top of the agitator. If it accidentally comes off, simply put it back on.

The **fabric softener dispenser** automatically releases liquid fabric softener at the proper time during the cycle.

*Do not stop the washer during the first spin. This will cause the dispenser to empty too soon.*

To use, follow these steps:

- 1 Make sure dispenser is securely attached to agitator.
- 2 Use only liquid fabric softener. Pour into dispenser, using amount recommended on package.

*Never pour fabric softener directly on clothes. It may stain them.*

- 3 Add water to dispenser until it reaches the maximum fill line.



*Do not pour anything into the agitator if the agitator cap or dispenser is removed.*



*Separate for cleaning.*

### Cleaning the Fabric Softener Dispenser (on some models)

- 1 Remove the dispenser from the top of the agitator.
- 2 Separate the dispenser cup from the cover by grasping the top and pushing down on the inside of the cup with your fingers. Dispenser cup will pop free from the cover.
- 3 To clean the dispenser, soak both the dispenser cup and the dispenser cover in the following solution:
  - 1 US gallon (3.8 liters) warm water
  - 1/4 cup (60 ml) heavy duty liquid detergent
  - 1 cup (240 ml) bleach
- 4 If necessary, loosen build-up with a clean, soft cloth after soaking. Do not use a stiff brush; you may roughen the surface of the dispenser.
- 5 Rinse and reassemble dispenser. Place dispenser back on the agitator.

## **Loading and using the washer.** *Always follow fabric manufacturer's care label when laundering.*



### *Sorting Wash Loads*

<b>Colors</b>	<b>Soil</b>	<b>Fabric</b>	<b>Lint</b>
Whites	Heavy	Delicates	Lint Producers
Lights	Normal	Easy Care	Lint Collectors
Darks	Light	Sturdy Cottons	

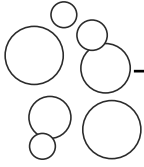

### *Proper Use of Detergent*

Add detergent and start the washer before adding clothes so that the detergent can work effectively. Using too little or too much detergent is a common cause of laundry problems.

You can use less detergent if you have soft water, a smaller load, or a lightly soiled load.



### *Loading the Washer*

Load dry items loosely, no higher than the top row of holes in the washer tub. When loading wet items make sure you set the load/water level high enough to allow the items to move freely. Water level should just cover the clothes. To add items after washer has started, push in Cycle knob and submerge additional items next to the agitator. Close the lid and pull Cycle knob out to restart.

- *Do not wrap large items like sheets around the agitator.*
- *Do not wash fabrics containing flammable materials (waxes, cleaning fluids, etc.).*
- *Agitation will not start with the lid up.*



## Care and Cleaning of the Washer

**Wash Basket:** Leave the lid open after washing to allow moisture to evaporate. If you want to clean the basket use a clean soft cloth dampened with liquid detergent, then rinse. (Do not use harsh or gritty cleaners.)

**Fill Hoses:** Hoses connecting washer to faucet should be replaced every 5 years.

**Lint Filter:** The lint filter is located under the agitator. It is self-cleaning and requires no maintenance.

**Exterior:** Immediately wipe off any spills. Wipe with damp cloth. Try not to hit surface with sharp objects.

**Moving and Storage:** Ask the service technician to remove water from drain pump and hoses. Do not store the washer where it will be exposed to the weather. Call the GE Answer Center®, 800.626.2000 for information on how to keep the tub stationary when moving the washer.

**Long Vacations:** Be sure water supply is shut off at faucets. Drain all water from hoses if weather will be below freezing.



## Fabric Care Labels

Below are fabric care label “symbols” that affect the clothing you will be laundering.

### WASH LABELS

<i>Machine wash cycle</i>						
	Normal	Permanent Press/ wrinkle resistant	Gentle/ delicate	Hand wash	Do not wash	Do not wring
<i>Water temperature</i>						
	Hot (50°C/120°F)	Warm (40°C/105°F)	Cold/cool (30°C/85°F)			

### DRY LABELS

<i>Tumble dry</i>						
	Dry	Normal	Permanent Press/ wrinkle resistant	Gentle/ delicate	Do not tumble dry	Do not dry (used with do not wash)
<i>Heat setting</i>						
	High	Medium	Low	No heat/air		
<i>Special instructions</i>						
	Line dry/ hang to dry	Drip dry	Dry flat	In the shade		

### BLEACH LABELS

<i>Bleach symbols</i>			
	Any bleach (when needed)	Only non-chlorine bleach (when needed)	Do not bleach

## Before you call for service...



**Troubleshooting Tips**  
Save time and money! Review the charts on the following pages first and you may not need to call for service.

<b>SENSORWASH</b>	<b>Possible Causes</b>	<b>What To Do</b>
<b>SensorWash indicator light (on some models) is not illuminated</b>	Washer is NOT in a wash fill cycle or a warm rinse fill cycle	<ul style="list-style-type: none"> <li>This is normal. Light only illuminates during wash fills and warm rinse fills.</li> </ul>
<b>SensorWash wash temperature is incorrect</b>	The washer is in a cold rinse cycle	<ul style="list-style-type: none"> <li>This is normal. The <b>SensorWash</b> feature is designed not to activate during a cold rinse cycle so that the coldest water available is used.</li> </ul>
<b>(Review SensorWash in the About washer features section)</b>	All the water in the water heater has been used	<ul style="list-style-type: none"> <li>Wait until the water in the water heater is heated to the correct temperature.</li> </ul>
<b>WATER</b>	<b>Possible Causes</b>	<b>What To Do</b>
<b>Too many suds</b>	Type of detergent	<ul style="list-style-type: none"> <li>Switch to a lower sudsing detergent brand and follow instructions on package.</li> </ul>
	Very soft water	<ul style="list-style-type: none"> <li>Try less detergent.</li> </ul>
	Too much detergent.	<ul style="list-style-type: none"> <li>Measure your detergent carefully. Use less soap if you have soft water, a smaller load, or a lightly soiled load.</li> </ul>
<b>Water leaks</b>	Fill hoses or drain hose is improperly connected	<ul style="list-style-type: none"> <li>Make sure hose connections are tight at faucets and make sure end of drain hose is correctly inserted in and secured to drain facility.</li> </ul>
	Household drain may be clogged	<ul style="list-style-type: none"> <li>Check household plumbing. You may need to call a plumber.</li> </ul>
	Constant water pressure to the fill hoses at the water source	<ul style="list-style-type: none"> <li>Tighten hoses at the faucets and turn the water off after each use.</li> <li>Check condition of the fill hoses; they may need replacement after 5 years.</li> </ul>
	Using too much detergent in washer	<ul style="list-style-type: none"> <li>Use less detergent. Use less soap if you have soft water, a smaller load, or a lightly soiled load.</li> </ul>
<b>Water temperature is incorrect</b>	Control is not set properly	<ul style="list-style-type: none"> <li>Check water temperature control and adjust.</li> </ul>
	Water supply is turned off or improperly connected	<ul style="list-style-type: none"> <li>Turn both hot and cold faucets fully on and make sure hoses are connected to correct faucets.</li> </ul>
	Water valve screens are stopped up	<ul style="list-style-type: none"> <li>Turn off the water source and remove the water connection hoses from the upper back of the washer. Use a brush or toothpick to clean the screens in the machine. Reconnect the hoses and turn the water back on.</li> </ul>
	House water heater is not set properly	<ul style="list-style-type: none"> <li>Make sure house water heater is delivering water at 120°F.-140°F. (48°C.-60°C.).</li> </ul>
<b>Water won't drain</b>	Drain hose is kinked or improperly connected	<ul style="list-style-type: none"> <li>Straighten drain hose and make sure washer is not sitting on it.</li> <li>Top of drain outlet should be less than 8 ft. above floor.</li> </ul>

<b>OPERATION</b>	<b>Possible Causes</b>	<b>What To Do</b>
<b>Washer pauses in cycle</b>	The washer normally pauses between washing steps	
<b>Washer won't operate</b>	<b>Washer is unplugged</b>	<ul style="list-style-type: none"> <li>• Make sure cord is plugged securely into a working outlet.</li> </ul>
	<b>Water supply is turned off</b>	<ul style="list-style-type: none"> <li>• Turn both hot and cold faucets fully on.</li> </ul>
	<b>Controls are not set properly</b>	<ul style="list-style-type: none"> <li>• Check controls and make sure Cycle knob is pulled out to <b>ON</b> position.</li> </ul>
	<b>Lid is open</b>	<ul style="list-style-type: none"> <li>• Close lid and pull Cycle knob out to <b>ON</b> position.</li> </ul>
	<b>Circuit breaker/fuse is tripped/blown</b>	<ul style="list-style-type: none"> <li>• Check house circuit breakers/fuses. Replace fuses or reset breaker. Washer should have separate outlet.</li> </ul>

<b>PERFORMANCE</b>	<b>Possible Causes</b>	<b>What To Do</b>	
<b>Clothes too wet</b>	<b>Incorrect spin cycle selected</b>	<ul style="list-style-type: none"> <li>• Make sure the spin cycle selected matches the load you are washing. Some fabrics will feel wetter when rinsed with cold water.</li> </ul>	
<b>Colored spots</b>	<b>Incorrect use of fabric softener</b>	<ul style="list-style-type: none"> <li>• Check fabric softener package for instructions and follow directions for using dispenser.</li> <li>• Pretreat stain and rewash.</li> </ul>	
	<b>Dye transfer</b>	<ul style="list-style-type: none"> <li>• Sort whites or lightly colored items from dark colors.</li> </ul>	
<b>Grayed or yellowed clothes</b>	<b>Not enough detergent</b>	<ul style="list-style-type: none"> <li>• Use more detergent (especially with larger loads).</li> </ul>	
	<b>Hard water</b>	<ul style="list-style-type: none"> <li>• Use a water conditioner like Calgon brand or install a water softener.</li> </ul>	
	<b>Water is not hot enough</b>	<ul style="list-style-type: none"> <li>• Make sure water heater is delivering water at 120°F.–140°F. (48°C.–60°C.).</li> </ul>	
	<b>Washer is overloaded</b>	<ul style="list-style-type: none"> <li>• Select load size to match clothes load.</li> </ul>	
	<b>Detergent is not dissolving</b>	<ul style="list-style-type: none"> <li>• Add detergent as wash basket fills with water before you load clothes.</li> </ul>	
	<b>Dye transfer</b>	<ul style="list-style-type: none"> <li>• Sort clothes by color. If fabric label states <i>wash separately</i>, unstable dyes may be indicated.</li> </ul>	
<b>Lint or residue on clothes</b>	<b>Clothes are air or line dried</b>	<ul style="list-style-type: none"> <li>• If you do not dry your clothes with a clothes dryer, your clothes may retain more lint.</li> </ul>	
	<b>Incorrect sorting</b>	<ul style="list-style-type: none"> <li>• Separate lint producers from lint collectors.</li> </ul>	
	<b>Washing too long</b>	<ul style="list-style-type: none"> <li>• Wash small loads for a shorter time than larger loads.</li> </ul>	
	<b>Detergent not dissolving</b>	<ul style="list-style-type: none"> <li>• Add detergent as wash basket fills with water, before you load clothes.</li> <li>• Try a liquid detergent.</li> <li>• Use warmer water temperature.</li> </ul>	
		<b>Overloading</b>	<ul style="list-style-type: none"> <li>• Load clothes no higher than the top row of holes in the washer tub.</li> <li>• Make sure load size selector matches clothes load size.</li> </ul>
		<b>Incorrect use of fabric softener</b>	<ul style="list-style-type: none"> <li>• Check fabric softener package for instructions and follow directions for using dispenser.</li> </ul>

## Before you call for service...

<i>(con) PERFORMANCE</i>	<i>Possible Causes</i>	<i>What To Do</i>
<b>Pilling</b>	Result of normal wear on poly-cotton blends and fuzzy fabrics	<ul style="list-style-type: none"> <li>• While this is not caused by the washer, you can slow the pilling process by washing garments inside out.</li> </ul>
<b>Snags, holes, tears, rips or excessive wear</b>	Pins, snaps, hooks, sharp buttons, belt buckles, zippers, and sharp objects left in pockets	<ul style="list-style-type: none"> <li>• Fasten snaps, hooks, buttons, and zippers.</li> <li>• Remove loose items like pins, objects in pockets and sharp buttons.</li> <li>• Turn knits (which snag easily) inside out.</li> </ul>
	Undiluted chlorine bleach	<ul style="list-style-type: none"> <li>• Check bleach package instructions for proper amount.</li> <li>• Never add undiluted bleach to wash or allow clothes to come in contact with undiluted bleach.</li> </ul>
	Chemicals like hair bleach or dye, permanent wave solution	<ul style="list-style-type: none"> <li>• Rinse items that may have chemicals on them before washing.</li> </ul>
<b>Wrinkling</b>	Improper sorting	<ul style="list-style-type: none"> <li>• Avoid mixing heavy items (like work clothes) with light items (like blouses).</li> <li>• Try a fabric softener.</li> </ul>
	Overloading or incorrect water level	<ul style="list-style-type: none"> <li>• Load your washer so clothes have enough room to move freely.</li> </ul>
	Incorrect wash and dry cycles	<ul style="list-style-type: none"> <li>• Match Cycle selection to the type of fabric you are washing (especially for easy care loads).</li> </ul>
	Repeated washing in water that is too hot	<ul style="list-style-type: none"> <li>• Wash in warm or cold water.</li> </ul>

<b>NOISE</b>	<i>Possible Causes</i>	<i>What To Do</i>
<b>Washer is noisy</b>	Washer is uneven	<ul style="list-style-type: none"> <li>• To level the front of the washer, adjust the front leveling legs by rotating the individual leg in the proper direction for up or down. To level back of washer, lift back of machine 4" and set down.</li> </ul>
	Washer load is unbalanced	<ul style="list-style-type: none"> <li>• Push the Cycle knob in to stop the washer, open the lid and redistribute the load evenly. Close the lid and restart.</li> </ul>
	Shipping rod is still assembled in unit	<ul style="list-style-type: none"> <li>• To remove shipping rod from washer, pull yellow tag and attached rod from the bottom right hand side of washer.</li> </ul>
	Washer is sitting too close to wall (causes knocking during cycle)	<ul style="list-style-type: none"> <li>• Pull washer away from the wall; about 4" is needed.</li> </ul>

<b>OTHER</b>	<i>Possible Causes</i>	<i>What To Do</i>
<b>Labels on the exterior of the washer will not peel off cleanly</b>	Occasionally the adhesive used on the labels does not release cleanly	<ul style="list-style-type: none"> <li>• Use a hair dryer set at the lowest heat setting, directing the air at the label for a short amount of time. This will release the adhesive easily, without damaging the surface of the washer.</li> </ul>

# GE Washer Warranty



All warranty service provided by our Factory Service Centers or an authorized Customer Care® technician. For service, call 800-GE-CARES.

## For The Period Of:

## We Will Replace:

### One Year

From the date of the original purchase

**Any part** of the washer which fails due to a defect in materials or workmanship. During this **full one-year warranty**, we will also provide, **free of charge**, all labor and in-home service to replace the defective part.

### Five Years

From the date of the original purchase

**The transmission, suspension rod, spring assembly, washer lid and cover**, if any should fail due to a defect in materials or workmanship. During this **five-year limited warranty**, you will be responsible for any labor or in-home service costs.

### Ten Years

From the date of the original purchase

**The washer tub**, if it should fail due to a defect in materials or workmanship. During this **ten-year limited warranty**, you will be responsible for any labor or in-home service costs.

### Twenty Years

From the date of the original purchase

**The washer basket**, if it should fail due to a defect in materials or workmanship. During this **twenty-year limited warranty**, you will be responsible for any labor or in-home service costs.

## What Is Not Covered:

- Service trips to your home to teach you how to use the product.
- Improper installation.
- Failure of the product if it is abused, misused, or used for other than the intended purpose or used commercially.
- Replacement of house fuses or resetting of circuit breakers.
- Damage to the product caused by accident, fire, floods or acts of God.
- Incidental or consequential damage to personal property caused by possible defects with this appliance.

This warranty is extended to the original purchaser and any succeeding owner for products purchased for home use within the USA. In Alaska, the warranty excludes the cost of shipping or service calls to your home.

Some states do not allow the exclusion or limitation of incidental or consequential damages. This warranty gives you specific legal rights, and you may also have other rights which vary from state to state. To know what your legal rights are, consult your local or state consumer affairs office or your state's Attorney General.

Warrantor: General Electric Company. Louisville, KY 40225

## Service Telephone Numbers.

---

Safety Instructions



### GE Answer Center® 800.626.2000

The GE Answer Center® is open 24 hours a day, 7 days a week.



### In-Home Repair Service 800-GE-CARES (800-432-2737)

Expert GE repair service is only a phone call away.

Operating Instructions



### Special Needs Service 800.626.2000

#### 800-TDD-GEAC (800-833-4322)

GE offers, free of charge, a brochure to assist in planning a barrier-free kitchen for persons with limited mobility.



### Service Contracts 800-626-2224

Purchase a GE service contract while your warranty is still in effect and you'll receive a substantial discount. GE Consumer Service will still be there after your warranty expires.

Troubleshooting Tips



### Parts and Accessories 800-626-2002

Individuals qualified to service their own appliances can have parts or accessories sent directly to their homes (VISA, MasterCard and Discover cards are accepted).

**Instructions contained in this manual cover procedures to be performed by any user. Other servicing generally should be referred to qualified service personnel. Caution must be exercised, since improper servicing may cause unsafe operation.**



### Service Satisfaction

If you are not satisfied with the service you receive from GE:

**First**, contact the people who serviced your appliance.

**Next**, if you are still not pleased, write all the details—including your phone number—to:

Manager, Customer Relations  
GE Appliances  
Appliance Park  
Louisville, KY 40225

**Finally**, if your problem is still not resolved, write:

Major Appliance Consumer Action Program  
20 North Wacker Drive  
Chicago, IL 60606

Customer Service