

This Owner's Manual is provided and hosted by [Appliance Factory Parts](#).

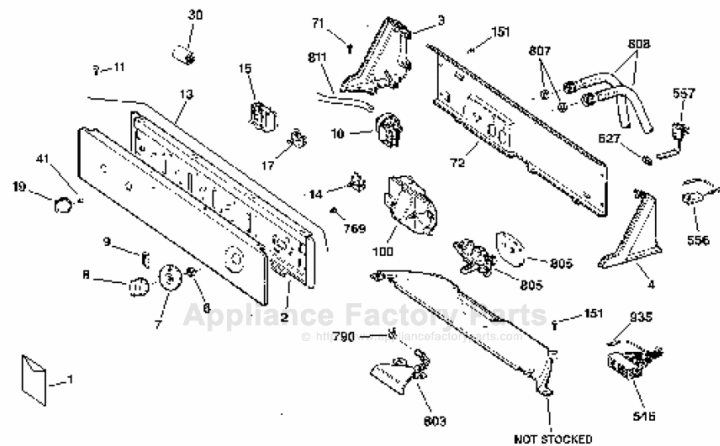

# GE WISR309DGCWW Owner's Manual

[Shop genuine replacement parts for GE  
WISR309DGCWW](#)



[Find Your GE Washer Parts - Select From 4591 Models](#)

----- Manual continues below -----

# Washers

**Safety Instructions** .....2, 3

**Operating Instructions**

Care and Cleaning  
of the Washer ..... 7  
Control Panels .....4  
Control Settings .....4, 5  
Features .....6  
Loading and Using  
the Washer ..... 7

**Troubleshooting Tips** .....8-10

**Owner's Manual**

WISR106

WISR309

WISR409

## IMPORTANT SAFETY INFORMATION. READ ALL INSTRUCTIONS BEFORE USING.

### **⚠ WARNING!**

For your safety, the information in this manual must be followed to minimize the risk of fire or explosion, electric shock, or to prevent property damage, personal injury, or loss of life.



### WATER HEATER SAFETY

Under certain conditions, hydrogen gas may be produced in a water heater that has not been used for two weeks or more. Hydrogen gas can be explosive under these circumstances.

If the hot water has not been used for two weeks or more, prevent the possibility of damage or injury by turning on all hot water faucets and allowing them to run for several minutes. Do this before using any electrical appliance which is connected to the hot water system. This simple procedure will allow any built-up hydrogen gas to escape. Since the gas is flammable, do not smoke or use an open flame or appliance during this process.



### PROPER INSTALLATION

This washer must be properly installed and located in accordance with the Installation Instructions before it is used.

- Install or store where it will not be exposed to temperatures below freezing or exposed to the weather, which could cause permanent damage and invalidate the warranty.
- Properly ground washer to conform with all governing codes and ordinances. Follow details in Installation Instructions.



### YOUR LAUNDRY AREA

- Keep the area underneath and around your appliances free of combustible materials such as lint, paper, rags, chemicals, etc.
- Close supervision is necessary if this appliance is used by or near children. Do not allow children to play on, with or inside this or any other appliance.



## WHEN USING THE WASHER

Use this appliance only for its intended purpose as described in this Owner's Manual.

- Never reach into washer while it is moving. Wait until the machine has completely stopped before opening the lid.
- Do not mix chlorine bleach with ammonia or acids such as vinegar and/or rust remover. Mixing different chemicals can produce a toxic gas which may cause death.
- Do not wash or dry articles that have been cleaned in, washed in, soaked in or spotted with combustible or explosive substances (such as wax, oil, paint, gasoline, degreasers, dry-cleaning solvents, kerosene, etc.). These substances give off vapors that may ignite or explode. Do not add these substances to the wash water. Do not use or place these substances around your washer or dryer during operation.
- The laundry process can reduce the flame retardancy of fabrics. To avoid such a result, carefully follow the garment manufacturer's wash and care instructions.
- To minimize the possibility of electric shock, unplug this appliance from the power supply or disconnect the washer at the building's distribution panel by removing the fuse or switching off the circuit breaker before attempting any maintenance or cleaning.
 

**NOTE:** Turning the Cycle Selector Knob to an off position, or pressing PAUSE does **NOT** disconnect the appliance from the power supply.
- Never attempt to operate this appliance if it is damaged, malfunctioning, partially disassembled, or has missing or broken parts, including a damaged cord or plug.



## WHEN NOT IN USE

- Turn off water faucets to relieve pressure on hoses and valves and to minimize leakage if a break or rupture should occur. Check the condition of the fill hoses; GE recommends changing the hoses every 5 years.
- Do not attempt to repair or replace any part of this appliance unless specifically recommended in this Owner's Manual, or in published user-repair instructions that you understand and have the skills to carry out.
- Before discarding a washer, or removing it from service, remove the washer lid to prevent children from hiding inside.
- Do not tamper with controls.



**READ AND FOLLOW THIS SAFETY INFORMATION CAREFULLY.**

**SAVE THESE INSTRUCTIONS**

## About the control panel.

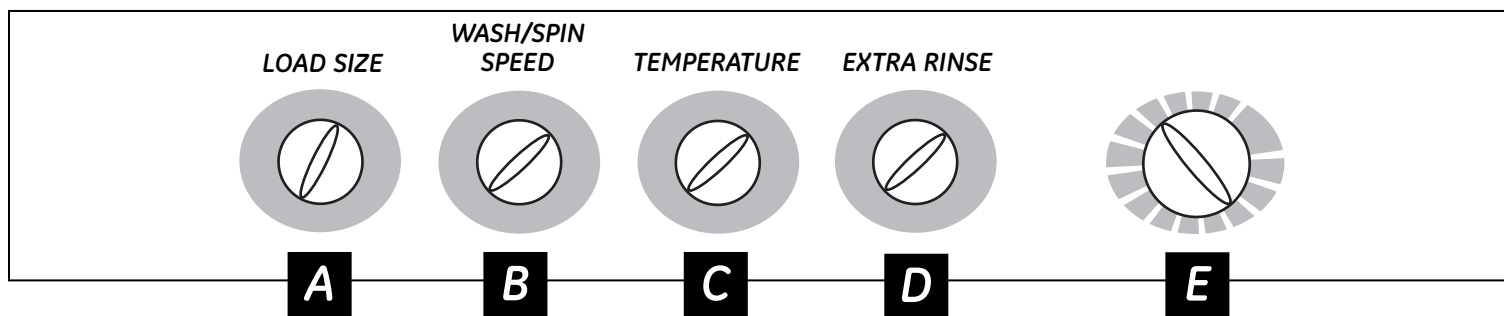
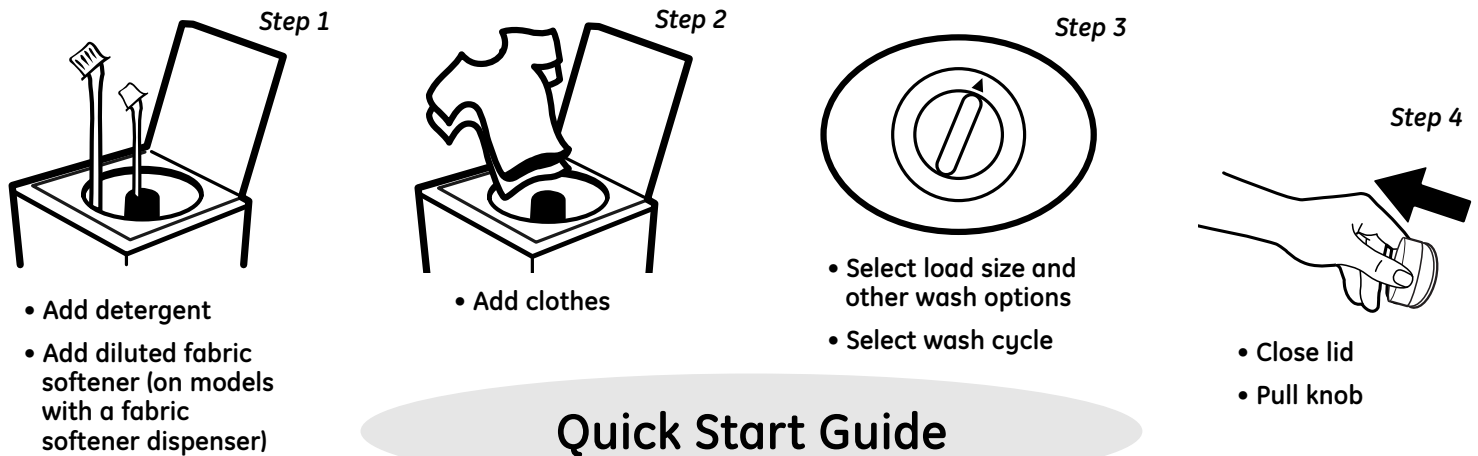

## Controls

### **A** Load Size

Loosely load clothes no higher than the top row of holes in the washer basket. The water level should just cover the clothes. Adjust the load size accordingly.

### **B** Wash/Spin Speed (on some models)

This refers to the speed of the agitator during the wash cycle and the basket during the spin cycle.

With NORMAL wash speed, the agitator moves faster. Use for cottons, denims and play clothes. With the GENTLE wash speed, the agitator moves slower. Use for delicate and knit items.

The Fast Spin Speed is for durable items. The Slow Spin Speed is for delicate items like sweaters and lingerie. Clothes will be less dry than when using the Fast Spin Speed.

### **C** Temperature (on some models)

Select the water temperature for the wash and rinse cycles. Always follow fabric manufacturer's care label or instructions when laundering.

### **D** Extra Rinse (on some models)

When you use extra detergent or bleach to clean heavily soiled clothes, you may want to use the Extra Rinse option. It provides a second deep cold rinse.

## **E** Wash Cycle—Cycle Selector Knob

The chart below will help you match the wash cycle setting with your clothing. The chart is ranked from longest to shortest cycle time and wash intensity.

Your washer may not have all these cycles. (Cycles vary by model.)

<b>COTTONS REGULAR</b>	For heavy to lightly soiled cottons, household linens, work and play clothes. With Light Soil or SHORT WASH being the shortest and REGULAR/HEAVY being the longest regular warm wash cycle.
<b>PERMANENT PRESS</b>	For synthetics and blends with normal soil.
<b>KNITS</b>	Specially designed for normally soiled knits.
<b>DELICATES</b>	For lingerie and special care fabrics with light to normal soil.
<b>AUTO SOAK</b>	For heavily soiled clothes with the HOT-COLD Wash temperature. Begins with a brief agitation, soaks for a specified period of time, agitates again, then moves through the rest of the cycle automatically.

## About washer features.

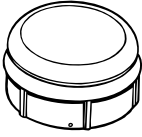

### **The Agitator Cap or Fabric Softener Dispenser** (depending on model)

**The agitator cap** fits into the top of the agitator. If it accidentally comes off, simply put it back on.

**The fabric softener dispenser** automatically releases liquid fabric softener at the proper time during the cycle.

**Do not stop the washer during the first spin. This will cause the dispenser to empty too soon.**

To use, follow these steps:

- 1** Make sure dispenser is securely attached to agitator.
- 2** Use only liquid fabric softener. Pour into dispenser, using amount recommended on package.

**Never pour fabric softener directly on clothes. It may stain them.**

- 3** Add water to dispenser until it reaches the maximum fill line.

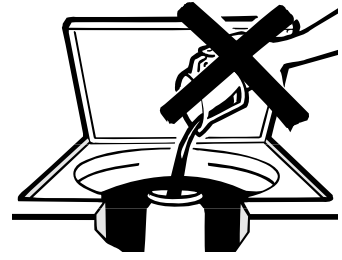

*Do not pour anything into the agitator if the agitator cap or dispenser is removed.*

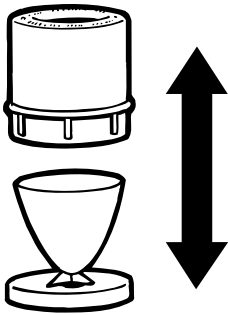

Separate for cleaning

### **Cleaning the Fabric Softener Dispenser** (on some models)

- 1** Remove the dispenser from the top of the agitator.
- 2** Separate the dispenser cup from the cover by grasping the top and pushing down on the inside of the cup with your fingers. Dispenser cup will pop free from the cover.
- 3** To clean the dispenser, soak both the dispenser cup and the dispenser cover in the following solution:
  - 1 US gallon (3.8 liters) warm water
  - 1/4 cup (60 ml) heavy-duty liquid detergent
  - 1 cup (240 ml) bleach
- 4** If necessary, loosen buildup with a clean, soft cloth after soaking. Do not use a stiff brush; you may roughen the surface of the dispenser.
- 5** Rinse and reassemble dispenser. Place dispenser back on the agitator.

### **Liquid Bleach Funnel**

The water fill dilutes liquid chlorine bleach as the washer fills for the wash cycle.

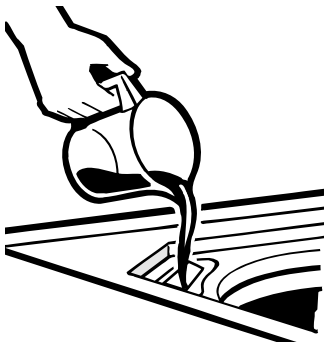

- 1** Check clothing care labels for special instructions.
- 2** Measure liquid bleach carefully, following instructions on the bottle.
  - Never pour undiluted liquid chlorine bleach directly onto clothes or into the wash basket.
  - Do not pour powdered bleach into bleach funnel.
- 3** Before starting the washer, pour measured amount of bleach directly into bleach funnel. Avoid splashing or over-filling dispenser. If you prefer to use powdered bleach, add it into the wash basket with your detergent.
  - Do not mix chlorine bleach with ammonia or acids such as vinegar and/or rust remover. Mixing can produce a toxic gas which may cause death.

# Loading and using the washer.

Always follow fabric manufacturer's care label when laundering.



## Sorting Wash Loads

Sort by color (whites, lights, colors), soil level, fabric type (sturdy cottons, easy care, delicates) and whether the fabric produces lint (terry cloth, chenille) or collects lint (velveteen, corduroy).

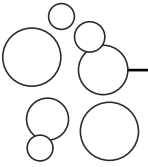

## Proper Use of Detergent

Add detergent and start the washer before adding clothes so that the detergent can work effectively. Using too little or too much detergent is a common cause of laundry problems.

You can use less detergent if you have soft water, a smaller load or a lightly soiled load.



## Loading the Washer

Load dry items loosely, no higher than the top row of holes in the washer basket. When loading wet items, make sure you set the load/water level high enough to allow the items to move freely. Water level should just cover the clothes. To add items after washer has started, lift the lid and submerge additional items next to the agitator.

- Do not wrap long items like sheets or pants around the agitator.
- Do not wash fabrics containing flammable materials (waxes, cleaning fluids, etc.).
- Agitation will not start with the lid up.

# Care and cleaning of the washer.



**Wash Basket:** Leave the lid open after washing to allow moisture to evaporate. If you want to clean the basket, use a clean soft cloth dampened with liquid detergent; then rinse. (Do not use harsh or gritty cleaners.)

**Fill Hoses:** We recommend changing the hoses every 5 years.

**Exterior:** Immediately wipe off any spills. Wipe with damp cloth. Try not to hit surface with sharp objects.

**Moving and Storage:** Ask the service technician to remove water from drain pump and hoses. See the Installation Instructions packed with product for information on how to reinstall the shipping rod to keep the tub stationary when moving the washer. Do not store the washer where it will be exposed to the weather.

**Long Vacations:** Be sure water supply is shut off at faucets. Drain all water from hoses if weather will be below freezing.

## Before you call for service...



### Troubleshooting Tips

Save time and money! Review the charts on the following pages and you may not need to call for service.

<b>WATER</b>	<b>Possible Causes</b>	<b>What To Do</b>
<i>Too many suds</i>	<b>Too much detergent</b>	<ul style="list-style-type: none"> <li>Measure your detergent carefully. Use less soap if you have soft water, a smaller load or a lightly soiled load.</li> </ul>
	<b>Type of detergent</b>	<ul style="list-style-type: none"> <li>Switch to a lower sudsing detergent brand and follow instructions on package.</li> </ul>
	<b>Soft water</b>	<ul style="list-style-type: none"> <li>Try less detergent.</li> </ul>
<i>Water leaks</i>	<b>Using too much detergent in washer</b>	<ul style="list-style-type: none"> <li>Use less detergent. Use less soap if you have soft water, a smaller load or a lightly soiled load.</li> </ul>
	<b>Fill hoses or drain hose is improperly connected</b>	<ul style="list-style-type: none"> <li>Make sure hose connections are tight at faucets and rubber washers are installed. Make sure end of drain hose is correctly inserted in and secured to drain facility.</li> </ul>
	<b>Household drain may be clogged</b>	<ul style="list-style-type: none"> <li>Check household plumbing. You may need to call a plumber.</li> </ul>
	<b>Constant water pressure to the fill hoses at the water source</b>	<ul style="list-style-type: none"> <li>Tighten hoses at the faucets and turn the water off after each use.</li> <li>Check condition of the fill hoses; they should be replaced every 5 years.</li> </ul>
<i>Water temperature seems incorrect</i>	<b>Cooler water temperatures provide improved energy efficiency</b>	<ul style="list-style-type: none"> <li>New laundry detergents have been formulated to work with cooler water temperatures without affecting wash performance.</li> </ul>
	<b>Water supply is turned off or improperly connected</b>	<ul style="list-style-type: none"> <li>Turn both hot and cold faucets fully on and make sure hoses are connected to correct faucets.</li> </ul>
	<b>Water valve screens are stopped up</b>	<ul style="list-style-type: none"> <li>Turn off the water source and remove the water connection hoses from the upper back of the washer. Use a brush or toothpick to clean the screens in the machine. Reconnect the hoses and turn the water back on.</li> </ul>
	<b>House water heater is not set properly</b>	<ul style="list-style-type: none"> <li>Make sure house water heater is delivering water at 120°F–140°F (48°C–60°C).</li> </ul>
<i>Water pumped out before cycle is complete</i>	<b>Lid lifted or cycle was put in pause for over 24 hours</b>	<ul style="list-style-type: none"> <li>Reset cycle.</li> </ul>
<i>Water won't drain</i>	<b>Drain hose is kinked or improperly connected</b>	<ul style="list-style-type: none"> <li>Straighten drain hose and make sure washer is not sitting on it.</li> <li>Top of drain outlet should be less than 8 ft (2.5 m) above floor.</li> </ul>
<i>Washer pauses during wash cycle</i>	<b>The AUTO SOAK Option was chosen</b>	<ul style="list-style-type: none"> <li>This is normal. The washer alternates between agitate and soak during these cycles to get your clothes cleaner with less wear.</li> </ul>
<i>Washer pauses during spin cycle</i>	<b>This is normal</b>	<ul style="list-style-type: none"> <li>The washer may pause during the spin cycle to remove soapy water more efficiently.</li> </ul>

<b>OPERATION</b>	<b>Possible Causes</b>	<b>What To Do</b>	
<b>Washer won't operate</b>	<b>Washer is unplugged</b>	<ul style="list-style-type: none"> <li>• Make sure cord is plugged securely into a working outlet.</li> </ul>	
	<b>Water supply is turned off</b>	<ul style="list-style-type: none"> <li>• Turn both hot and cold faucets fully on.</li> </ul>	
	<b>Controls are not set properly</b>	<ul style="list-style-type: none"> <li>• Check controls.</li> </ul>	
	<b>Lid is open—safety feature prevents agitation and spinning when lid is up</b>	<ul style="list-style-type: none"> <li>• Close lid and reset cycle, to the beginning if necessary.</li> </ul>	
	<b>Circuit breaker/fuse is tripped/blown</b>	<ul style="list-style-type: none"> <li>• Check house circuit breakers/fuses. Replace fuses or reset breaker. Washer should have separate outlet.</li> </ul>	
	<b>Lid magnet missing</b>	<ul style="list-style-type: none"> <li>• Call for service.</li> </ul>	
<b>Time not shown on display</b>	<b>Unit filling</b>	<ul style="list-style-type: none"> <li>• This is normal. Estimated time remaining is updated during fill time.</li> </ul>	
<b>Movement inside machine when shut off</b>	<b>Shifting mechanism is disengaging the motor</b>	<ul style="list-style-type: none"> <li>• When the machine is manually turned off, the shifter will disengage the motor before completely shutting down. If lid is raised before the motor is disengaged, it will resume when lid is closed.</li> </ul>	
<b>PERFORMANCE</b>	<b>Possible Causes</b>	<b>What To Do</b>	
<b>Clothes too wet</b>	<b>Incorrect spin cycle selected</b>	<ul style="list-style-type: none"> <li>• Make sure the spin cycle selected matches the load you are washing. Some fabrics will feel wetter when rinsed with cold water.</li> </ul>	
<b>Colored spots</b>	<b>Incorrect use of fabric softener</b>	<ul style="list-style-type: none"> <li>• Check fabric softener package for instructions and follow directions for using dispenser.</li> <li>• Pretreat stain and rewash.</li> </ul>	
	<b>Dye transfer</b>	<ul style="list-style-type: none"> <li>• Sort whites or lightly colored items from dark colors.</li> </ul>	
<b>Grayed or yellowed clothes</b>	<b>Not enough detergent</b>	<ul style="list-style-type: none"> <li>• Use more detergent (especially with larger loads). Be sure to follow detergent manufacturer's directions.</li> </ul>	
	<b>Hard water</b>	<ul style="list-style-type: none"> <li>• Use a water conditioner like Calgon brand or install a water softener.</li> </ul>	
	<b>Water is not hot enough</b>	<ul style="list-style-type: none"> <li>• Make sure water heater is delivering water at 120°F–140°F (48°C–60°C).</li> </ul>	
	<b>Washer is overloaded</b>	<ul style="list-style-type: none"> <li>• Select load size to match clothes load.</li> </ul>	
	<b>Detergent is not dissolving</b>	<ul style="list-style-type: none"> <li>• Add detergent as wash basket fills with water before you load clothes.</li> </ul>	
	<b>Dye transfer</b>	<ul style="list-style-type: none"> <li>• Sort clothes by color. If fabric label states <i>wash separately</i>, unstable dyes may be indicated.</li> </ul>	
<b>Lint or residue on clothes</b>	<b>Clothes are air or line dried</b>	<ul style="list-style-type: none"> <li>• If you do not dry your clothes with a clothes dryer, your clothes may retain more lint.</li> </ul>	
	<b>Incorrect sorting</b>	<ul style="list-style-type: none"> <li>• Separate lint producers from lint collectors.</li> </ul>	
	<b>Washing too long</b>	<ul style="list-style-type: none"> <li>• Wash small loads for a shorter time than larger loads.</li> </ul>	
	<b>Detergent not dissolving</b>	<ul style="list-style-type: none"> <li>• Add detergent as wash basket fills with water, before you load clothes.</li> <li>• Try a liquid detergent.</li> <li>• Use warmer water temperature.</li> </ul>	
		<b>Overloading</b>	<ul style="list-style-type: none"> <li>• Load clothes no higher than the top row of holes in the washer basket.</li> <li>• Make sure load size selected matches clothes load size.</li> </ul>
		<b>Incorrect use of fabric softener</b>	<ul style="list-style-type: none"> <li>• Check fabric softener package for instructions and follow directions for using dispenser.</li> </ul>

## Before you call for service...



### Troubleshooting Tips

<b>PERFORMANCE (cont.)</b>	<b>Possible Causes</b>	<b>What To Do</b>
<b>Pilling</b>	Result of normal wear on poly-cotton blends and fuzzy fabrics	<ul style="list-style-type: none"> <li>While this is not caused by the washer, you can slow the pilling process by washing garments inside out.</li> </ul>
<b>Snags, holes, tears, rips or excessive wear</b>	Pins, snaps, hooks, sharp buttons, belt buckles, zippers and sharp objects left in pockets	<ul style="list-style-type: none"> <li>Fasten snaps, hooks, buttons and zippers.</li> <li>Remove loose items like pins, objects in pockets and sharp buttons.</li> <li>Turn knits (which snag easily) inside out.</li> </ul>
	Undiluted chlorine bleach	<ul style="list-style-type: none"> <li>Check bleach package instructions for proper amount.</li> <li>Never add undiluted bleach to wash or allow clothes to come in contact with undiluted bleach.</li> </ul>
	Chemicals like hair bleach or dye, permanent wave solution	<ul style="list-style-type: none"> <li>Rinse items that may have chemicals on them before washing.</li> </ul>
<b>Wrinkling</b>	Improper sorting	<ul style="list-style-type: none"> <li>Avoid mixing heavy items (like work clothes) with light items (like blouses).</li> <li>Try a fabric softener.</li> </ul>
	Overloading or incorrect water level	<ul style="list-style-type: none"> <li>Load your washer so clothes have enough room to move freely with water covering all of the clothes.</li> </ul>
	Incorrect wash and dry cycles	<ul style="list-style-type: none"> <li>Match Cycle selection to the type of fabric you are washing (especially for easy care loads).</li> </ul>
	Repeated washing in water that is too hot	<ul style="list-style-type: none"> <li>Wash in warm or cold water.</li> </ul>
<b>SOUNDS</b>	<b>Possible Causes</b>	<b>What To Do</b>
<b>"Metallic knocking"</b>	Shifter mechanism is engaging or disengaging	<ul style="list-style-type: none"> <li>The drive system will engage at the start of agitate and disengage when agitate is complete. This occurs multiple times during the wash.</li> </ul>
<b>Back and forth "swoosh" or "zip" sound during agitate</b>	Electric motor reversing direction	<ul style="list-style-type: none"> <li>This machine has a drive system that doesn't use gears. This sound is the motor rotating back and forth to agitate your laundry.</li> </ul>
<b>Quick short agitation sounds at end of agitate</b>	Clothing redistribution	<ul style="list-style-type: none"> <li>At the end of agitate, the motor makes short agitation strokes to redistribute the load.</li> </ul>
<b>"Click" when water stops filling</b>	Relay switch	<ul style="list-style-type: none"> <li>The relay makes a click sound when activated. The water level activates the relay and stops filling.</li> </ul>
<b>"Clicking" behind Control Panel during fill</b>	Automatic Temperature Control Valve	<ul style="list-style-type: none"> <li>This valve mixes in cold and hot water. The "clicking" is the valve turning on and off.</li> </ul>
<b>Water volume changes during fill</b>	Automatic Temperature Control Valve	<ul style="list-style-type: none"> <li>This valve mixes in cold and hot water. The sound changes when the valves are turned on and off.</li> </ul>
<b>Motor "whining up" or "coasting down" in spin</b>	Motor ramping up/down during spin cycle	<ul style="list-style-type: none"> <li>The motor will speed up incrementally during the spin cycle. When spin is complete, it will coast until it stops.</li> </ul>
<b>"Humming"</b>	Water drain pump	<ul style="list-style-type: none"> <li>The drain pump will make a humming sound when pumping out water after agitation stops and continue until spin is complete.</li> </ul>
<b>"Gurgling"</b>	Water drain pump	<ul style="list-style-type: none"> <li>When the pump starts drawing in air, it starts to gurgle. The washer should then begin spinning and the sound will continue until it is done spinning.</li> </ul>

**Notes.**

---

***Safety Instructions***

***Operating Instructions***

***Troubleshooting Tips***

***Consumer Support***

**Consumer Support**

**Troubleshooting Tips**

**Operating Instructions**

**Safety Instructions**

**Notes.**

---