

This Owner's Manual is provided and hosted by [Appliance Factory Parts](http://Appliance Factory Parts).

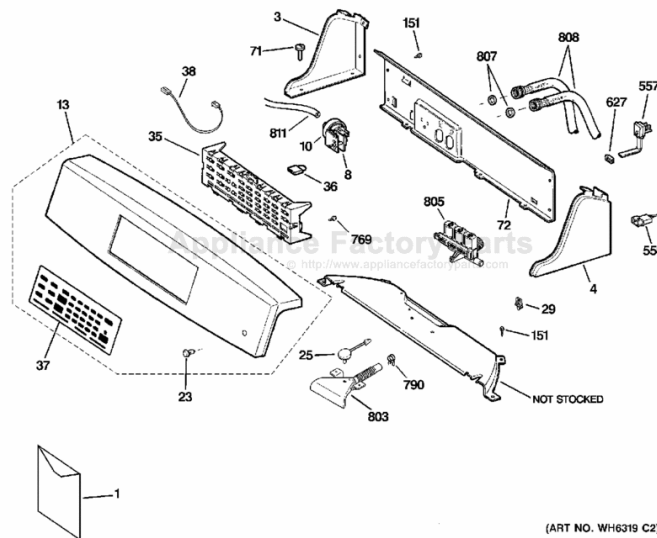

# GE WPRB9250D1CC Owner's Manual

[Shop genuine replacement parts for GE  
WPRB9250D1CC](#)



[Find Your GE Washer Parts - Select From 4591 Models](#)

----- Manual continues below -----



# Profile Washers

*Safety Instructions* . . . . . 2, 3

***Operating Instructions***

Clothes Care Cycles . . . . . 8, 9  
Controls . . . . . 4, 6  
Controls Features . . . . . 10  
Cycle Options . . . . . 10  
Easy Touch Selections . . . . . 5, 7  
Loading and Using  
the Washer . . . . . 13, 14  
Other Features . . . . . 11  
Quick Start Guides . . . . . 4, 6  
Washer Features . . . . . 8-12

***Troubleshooting Tips*** . . . . . 15-18

***Consumer Support***

Consumer Support . . . . . Back Cover  
Warranty . . . . . 19

**Owner's Manual**

WPRB9220

WPRB9250



As an ENERGY STAR® partner, GE has determined that this product meets the ENERGY STAR® guidelines for energy efficiency.

**Write the model and serial numbers here:**

**Model #** \_\_\_\_\_

**Serial #** \_\_\_\_\_

You can find them on the bottom right of the washer cabinet.



# IMPORTANT SAFETY INFORMATION. READ ALL INSTRUCTIONS BEFORE USING.

**⚠ WARNING!** For your safety, the information in this manual must be followed to minimize the risk of fire or explosion, electric shock, or to prevent property damage, personal injury, or loss of life.



## WATER HEATER SAFETY

Under certain conditions hydrogen gas may be produced in a water heater that has not been used for two weeks or more. Hydrogen gas can be explosive under these circumstances.

If the hot water has not been used for two weeks or more, prevent the possibility of damage or injury by turning on all hot water faucets and allowing them to run for several minutes. Do this before using any electrical appliance which is connected to the hot water system. This simple procedure will allow any built-up hydrogen gas to escape. Since the gas is flammable, do not smoke or use an open flame or appliance during this process.



## PROPER INSTALLATION

This washer must be properly installed and located in accordance with the Installation Instructions before it is used. If you did not receive an Installation Instructions sheet, you can receive one by visiting [www.GEAppliances.com](http://www.GEAppliances.com), or by calling **800.GE.CARES (800.432.2737)**.

- Install or store where it will not be exposed to temperatures below freezing or exposed to the weather.
- Remove the colored protective film from the control panel.
- Properly ground washer to conform with all governing codes and ordinances. Follow details in Installation Instructions.



## YOUR LAUNDRY AREA

- Keep the area underneath and around your appliances free of combustible materials such as lint, paper, rags, chemicals, etc.
- Close supervision is necessary if this appliance is used by or near children. Do not allow children to play on, with or inside this or any other appliance.



## WHEN USING THE WASHER

Use this appliance only for its intended purpose as described in this Owner's Manual.

- Never reach into washer while it is moving. Wait until the machine has completely stopped before opening the lid.
- Do not mix chlorine bleach with ammonia or acids such as vinegar and/or rust remover. Mixing different chemicals can produce a toxic gas which may cause death.
- Do not wash or dry articles that have been cleaned in, washed in, soaked in or spotted with combustible or explosive substances (such as wax, oil, paint, gasoline, degreasers, dry-cleaning solvents, kerosene, etc.). These substances give off vapors that may ignite or explode. Do not add these substances to the wash water. Do not use or place these substances around your washer or dryer during operation.
- The laundry process can reduce the flame retardancy of fabrics. To avoid such a result, carefully follow the garment manufacturer's wash and care instructions.
- To minimize the possibility of electric shock, unplug this appliance from the power supply or disconnect the washer at the household distribution panel by removing the fuse or switching off the circuit breaker before attempting any maintenance or cleaning. **NOTE: Pressing START, STOP or POWER does NOT disconnect the appliance from the power supply.**
- Never attempt to operate this appliance if it is damaged, malfunctioning, partially disassembled, or has missing or broken parts, including a damaged cord or plug.



## WHEN NOT IN USE

- Turn off water faucets to relieve pressure on hoses and valves and to minimize leakage if a break or rupture should occur. Check the condition of the fill hoses; they should be replaced every 5 years.
- Do not attempt to repair or replace any part of this appliance unless specifically recommended in this Owner's Manual, or in published user-repair instructions that you understand and have the skills to carry out.
- Before discarding a washer, or removing it from service, remove the washer lid to prevent children from hiding inside.
- Do not tamper with controls.



**READ AND FOLLOW THIS SAFETY INFORMATION CAREFULLY.  
SAVE THESE INSTRUCTIONS**

# Quick Start Guide for Model WPRB9220.

You can locate your model number on the bottom right of the washer cabinet.

- 1 Add detergent.  
Add diluted fabric softener (on models with a fabric softener dispenser).

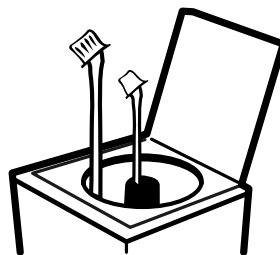

- 2 Loosely load clothes no higher than the top row of holes in the washer basket. The water level should just cover the clothes.

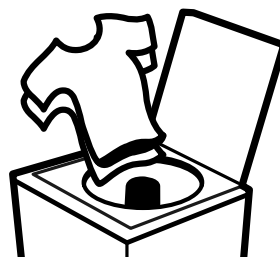

- 3 Select the wash cycle and other wash options.  
**NOTE:** Any time you make a selection that is incompatible with the chosen wash cycle, the washer will beep twice.

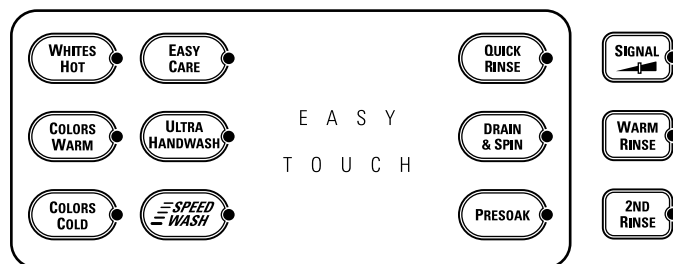

- 4 Change any of the automatic settings, if desired, by pressing the pad beneath the setting. Higher settings will:
  - Fill the washer basket with more water.
  - Remove heavier soil. The highest level is the Stain Wash cycle, with a 30 minute soak and agitation at the beginning of the wash cycle.
  - Add cold, warm or hot water. The Tap Cold selection may save energy by turning off the **PerfecTemp Plus** washer temperature control and using the household tap cold water temperature.
  - Spin faster to remove more water for shorter drying times.

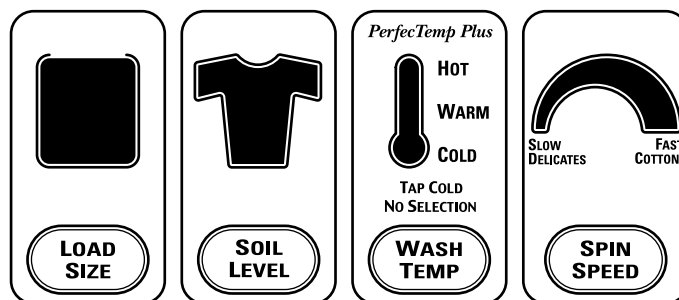





- 5 Close the lid and press **START**.



# Easy Touch Selections for Model WPRB9220.

Your new washer offers the convenience of starting your wash loads with our **EASY TOUCH** cycles. Make one simple selection, and your **LOAD SIZE, SOIL LEVEL, WASH TEMPERATURE** and **SPIN SPEED** are automatically set. Then all you have to do is press **START**.

	<b>Cycle</b>	<b>Wash Speed</b>	<b>Description</b>
	<b>WHITES HOT</b>	<b>Fast</b>	For heavy to lightly soiled white cottons, household linens, work and play clothes.
	<b>COLORS WARM</b>	<b>Fast</b>	For heavy to lightly soiled colorfast cottons, household linens, work and play clothes.
	<b>COLORS COLD</b>	<b>Medium</b>	For non-colorfast cottons and blends, and items that are labeled cold wash by the fabric manufacturer.
	<b>EASY CARE</b>	<b>Medium</b>	For knits, wrinkle-free and permanent press items.
	<b>ULTRA HANDWASH</b>	<b>Very Slow</b>	Uses an extra slow speed agitation combined with periods of soak to provide a true handwash for all of your delicate washables.

# Quick Start Guide for Model WPRB9250.

You can locate your model number on the bottom right of the washer cabinet.

- 1 Add detergent.  
Add diluted fabric softener (on models with a fabric softener dispenser).

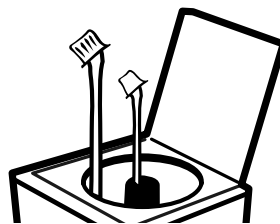

- 2 Loosely load clothes no higher than the top row of holes in the washer basket. The water level should just cover the clothes.

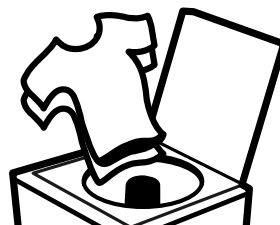

- 3 Select one of the three wash methods:
  - Press **WASH CYCLES** to wash according to load type.
  - Press **GARMENT CYCLES** to wash according to clothing type.
  - Press **STAIN CYCLES** to wash clothes with specific types of stains.

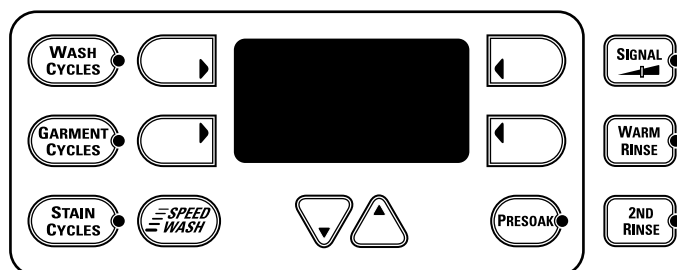

The **STAIN CYCLES** will provide you with tips on pretreating your stain and will then automatically select the washer settings for the optimum cycle to remove the stain.

Select the wash, garment or stain cycle by pressing the arrow pads (◀▶) at the sides of the display. You can scroll up and down through the list of cycles by pressing the **UP** (▲) and **DOWN** (▼) arrow pads beneath the display.

**NOTE:** Any time you make a selection that is incompatible with the chosen wash cycle, the washer will beep twice.

- 4 Change any of the automatic settings, if desired, by pressing the pad beneath the setting. Higher settings will:
  - Fill the washer basket with more water.
  - Remove heavier soil. The highest level is the Stain Wash cycle, with a 30 minute soak and agitation at the beginning of the wash cycle.
  - Add cold, warm or hot water. The Tap Cold selection may save energy by turning off the **PerfecTemp Plus** washer temperature control and using the household tap cold water temperature.
  - Spin faster to remove more water for shorter drying times.

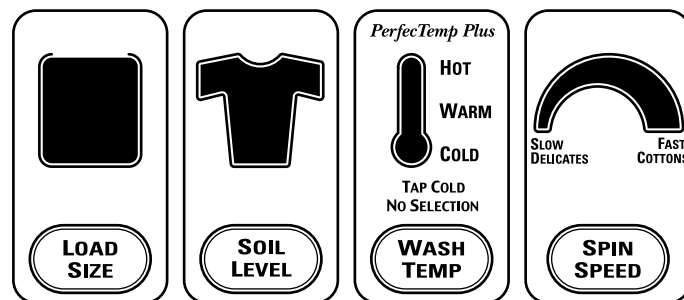

- 5 Close the lid and press **START**.



Your new washer offers the convenience of starting your wash loads with our **EASY TOUCH** cycles. Make one simple selection, and your **LOAD SIZE, SOIL LEVEL, WASH TEMPERATURE** and **SPIN SPEED** are automatically set. Then all you have to do is press **START**.



## WASH CYCLES

The **Wash Cycles** are optimized according to load type. The chart below will help you match the wash cycle setting with your clothing.

<b>Cycle</b>	<b>Wash Speed</b>	<b>Description</b>
<b>WHITES</b>	<b>Fast</b>	For heavy to lightly soiled white cottons, household linens, work and play clothes.
<b>COLORS</b>	<b>Fast</b>	For heavy to lightly soiled colorfast cottons, household linens, work and play clothes.
<b>DARK COLORS</b>	<b>Medium</b>	For non-colorfast cottons and blends, and items that are labeled cold wash by the fabric manufacturer.
<b>EASY CARE</b>	<b>Medium</b>	For wrinkle-free and permanent press items.
<b>CASUALS</b>	<b>Medium</b>	For wrinkle-free and permanent press items. Provides agitate/pause cycles to clean your items.
<b>KNITS</b>	<b>Medium</b>	Specially designed for normally soiled knits.
<b>DELICATES</b>	<b>Slow</b>	For lingerie and special-care fabrics with light to normal soil. Provides periods of agitation and soak during wash and rinse.
<b>ULTRA HANDWASH</b>	<b>Very Slow</b>	For items labeled hand-washable with light soils. Provides periods of agitation and soak during wash and rinse.
<b>QUICK RINSE</b>	<b>Medium</b>	For quickly rinsing chlorine, perspiration, stains, etc. out of clothes.
<b>DRAIN &amp; SPIN</b>	<b>Spin Only</b>	Drain and spin any cycle at any time.
<b>SOAK</b>	<b>Medium</b>	Provides a soak of up to 24 hours. The washer will drain and spin at the end of the cycle.
<b>SPEED WASH</b>	<b>Medium Fast</b>	For lightly soiled items that are needed in a hurry. Cycle time is approximately 20 minutes, depending on your household water pressure.



## GARMENT CYCLES

The **Garment Cycles** are customized to provide optimum washing for a variety of fabrics and clothing types. **Garment Cycles** include:

- Jeans
- Underwear
- Towels
- Infant Wear
- Khakis
- Play Clothes
- Mats/Rugs
- Lingerie
- Dress Shirts
- Everyday Wear
- Sheets
- Silks/Linen
- Knit Shirts
- Athletic Wear
- Table Linen



## STAIN CYCLES

The **Stain Cycles** are customized to provide optimum washing for specific types of stains. Press **STAIN CYCLES**, select the specific stain and follow the on-screen instructions. Stain selections include:

- |                    |                    |                       |                     |
|--------------------|--------------------|-----------------------|---------------------|
| <b>Food Stains</b> | <b>Body Stains</b> | <b>Outdoor Stains</b> | <b>Drink Stains</b> |
| ■ Catsup           | ■ Dingy Whites     | ■ Grass               | ■ Milk              |
| ■ Chocolate        | ■ Perspiration     | ■ Grease              | ■ Coffee/Tea        |
| ■ Meat Juices      | ■ Blood            | ■ Dirt                | ■ Juice/Wine        |
| ■ Egg              | ■ Underwear Stain  | ■ Ink                 | ■ Soft Drinks       |

## About Clothes Care Cycles.

---



### **PRESOAK**

*To presoak a load and go straight into a wash cycle:*

Select your wash cycle, press the **PRESOAK** pad, then press the **START** pad.

- Each time you press **PRESOAK**, you will add three minutes of agitation, followed by 12 minutes of soaking, for up to an hour of additional time. After the final soak period, the selected wash cycle begins.
  - Uses the speed and water temperature of your selected wash cycle.
- 



### **QUICK RINSE**

Use this feature to quickly rinse chlorine, perspiration, stains, etc. out of clothes.

- The washer fills with water, agitates for three minutes, drains and spins. You may change the automatic settings if desired.

*On some models, **QUICK RINSE** is found under the **WASH CYCLES** menu.*

---



### **SPEED WASH**

For lightly soiled items that are needed in a hurry. Cycle time is approximately 20 minutes, depending on your household water pressure.

---

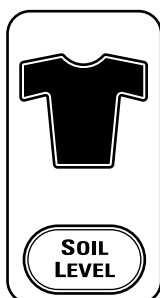

### **SOIL LEVEL**

The **SOIL LEVEL** setting determines the amount of agitation time.

The highest **SOIL LEVEL** is the Stain Wash cycle, which adds a 30 minute soak and agitation at the beginning of the selected wash cycle.



## **DRAIN & SPIN**

You can drain and spin any cycle at any time.

On models with a **DRAIN & SPIN** pad, press to drain and spin.

On models without a **DRAIN & SPIN** pad, press **START** to pause the washer, select **DRAIN & SPIN** from the **WASH CYCLES** menu, then press **START** again.



## **CUSTOM 1 and CUSTOM 2 (on some models)**

Set up your favorite combination of settings and save them here for one-touch recall.

These custom settings cannot be set while a cycle is in progress.

### **To store a custom combination of settings:**

1. Select an **EASY TOUCH** setting.
2. Change **LOAD SIZE, SOIL LEVEL, WASH TEMPERATURE** or **SPIN SPEED** to fit your needs.
3. Select any **OPTIONS** you want.
4. Press and hold the **CUSTOM 1** or **CUSTOM 2** pad until the washer beeps to store your selection.

### **To recall your stored combination:**

Press the **CUSTOM 1** or **CUSTOM 2** pad, then press **START**.

### **To reprogram the custom settings:**

**Repeat steps 1–4 above.**

## About controls features.



### START

- After you have selected a new cycle, press once to start the cycle.
- Press twice to select the last cycle used and start the washer.
- If the washer is running, press once to pause the cycle; press again to continue the cycle.



### STOP

If the washer is running, press once to pause the cycle; press again to cancel the cycle.

### TIME REMAINING



### Time Remaining

- Displays the approximate time remaining until the end of the cycle, or the time remaining for **DELAY START**.
- Cycle time is affected by how long it takes the washer to fill. This depends on the water pressure in your home. The “smart” timer “learns” the amount of time it takes to fill your washer and adjusts the total time accordingly.

## About cycle options.



### SIGNAL

Alerts you when the cycle is complete.

Press **SIGNAL** to select low, medium or high volume, or to turn the beeper off.



### 2ND RINSE

Adds a second cold rinse to any cycle.



### WARM RINSE

Changes the final rinse of a wash cycle from a cold to a warm rinse.

**NOTE:** **WARM RINSE** is not available when choosing a **HOT** wash temperature.



### DELAY START

Use to delay the start of your washer.

- 1 Choose your wash cycle and any options.
- 2 Press **DELAY START**. You can change the delay time in 30 minute increments by one of the following methods, depending on the model:
  - Using the arrow pads beneath the **Time Remaining** display
  - Repeatedly pressing the **DELAY START** pad until the desired time is shown
- 3 Press the **START** pad to start the countdown.

The countdown time will be shown in the **Time Remaining** display.

### CYCLE STATUS

- *FILL*      ● *RINSE*
- *SOAK*     ● *2<sup>NO</sup>RINSE*
- *WASH*    ● *SPIN*

### Cycle Status Indicators

On some models, cycle status indicator lights show what part of the cycle the washer is in. On models without indicator lights, the cycle status will show in the display.

## PerfectTemp Plus

### PerfectTemp Plus

**PerfectTemp Plus** senses the incoming water temperature and adjusts the temperature of the fill water to meet the clothing manufacturer's recommendations.

The lid must be closed for **PerfectTemp Plus** to work.

If your incoming water is too cold, detergent will not dissolve effectively and clothes may not get clean. If the water is too hot, fabrics could be damaged.

**PerfectTemp Plus** adjusts these water temperature extremes for better washing performance.

You may hear the water valves turning off and on while the water temperature is being adjusted. This is normal.

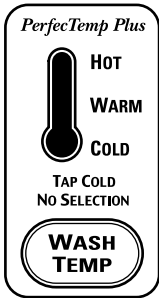

### Tap Cold

The Tap Cold feature turns the **PerfectTemp Plus** feature on your washer off, and uses your household tap water temperature for a COLD wash. This can provide energy savings by reducing the amount of hot water used in your wash.

During winter months when the water entering your home is colder, or for locations with very cold water year round, use the **PerfectTemp Plus** COLD to help dissolve powdered detergents and to improve the cleaning of your clothes.

## About washer features.

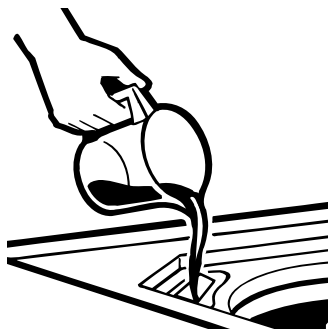

### Liquid Bleach Dispenser

The dispenser dilutes liquid chlorine bleach before it reaches your wash load.

- 1 Check clothing care labels for special instructions.
- 2 Measure liquid bleach carefully, following instructions on the bottle.
  - Never pour undiluted liquid chlorine bleach directly onto clothes or into the wash basket.
  - Do not pour powdered bleach into bleach dispenser.
- 3 Before starting the washer, pour measured amount of bleach directly into bleach dispenser. Avoid splashing or over-filling dispenser. If you prefer to use powdered bleach, add it into the wash basket with your detergent.
  - Do not mix chlorine bleach with ammonia or acids such as vinegar and/or rust remover. Mixing can produce a toxic gas which may cause death.

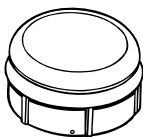

### The Agitator Cap or Fabric Softener Dispenser (depending on model)

**The agitator cap** fits into the top of the agitator. If it accidentally comes off, simply put it back on.

**The fabric softener dispenser** automatically releases liquid fabric softener at the proper time during the cycle.

**Do not stop the washer during the first spin. This will cause the dispenser to empty too soon.**

To use, follow these steps:

- 1 Make sure dispenser is securely attached to agitator.
- 2 Use only liquid fabric softener. Pour into dispenser, using amount recommended on package.

**Never pour fabric softener directly on clothes. It may stain them.**

- 3 Add water to dispenser until it reaches the maximum fill line.



*Do not pour anything into the agitator if the agitator cap or dispenser is removed.*

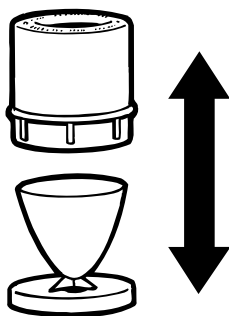

Separate for cleaning

### Cleaning the Fabric Softener Dispenser (on some models)

- 1 Remove the dispenser from the top of the agitator.
- 2 Separate the dispenser cup from the cover by grasping the top and pushing down on the inside of the cup with your fingers. Dispenser cup will pop free from the cover.
- 3 To clean the dispenser, soak both the dispenser cup and the dispenser cover in the following solution:
  - 1 US gallon (3.8 liters) warm water
  - 1/4 cup (60 ml) heavy duty liquid detergent
  - 1 cup (240 ml) bleach
- 4 If necessary, loosen build-up with a clean, soft cloth after soaking. Do not use a stiff brush; you may roughen the surface of the dispenser.
- 5 Rinse and reassemble dispenser. Place dispenser back on the agitator.

# Loading and using the washer.

Always follow fabric manufacturer's care label when laundering.

www.GEAppliances.com



## Sorting Wash Loads

Sort by color (whites, lights, colors), soil level, fabric type (sturdy cottons, easy care, delicates), and whether the fabric produces lint (terry cloth, chenille) or collects lint (velveteen, corduroy).

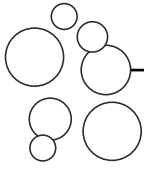

## Proper Use of Detergent

Using too much detergent is a common cause of laundry problems. Today's detergents are formulated to be effective without highly visible sudsing. Be sure to carefully read and follow manufacturer's recommendations for how much detergent to use in your wash.

**You can use less detergent if you have soft water, a smaller load or a lightly soiled load.**



## Loading the Washer

Load dry items loosely, no higher than the top row of holes in the washer basket. When loading wet items, make sure you set the load/water level high enough to allow the items to move freely. Water level should just cover the clothes. To add items after washer has started, lift the lid and submerge additional items next to the agitator.

- Do not wrap long items like sheets or pants around the agitator.
- Do not wash fabrics containing flammable materials (waxes, cleaning fluids, etc.).
- Agitation will not start with the lid up.

# Loading and using the washer.

Always follow fabric manufacturer's care label when laundering.



## Care and Cleaning of the Washer

**Wash Basket:** Leave the lid open after washing to allow moisture to evaporate. If you want to clean the basket, use a clean soft cloth dampened with liquid detergent, then rinse. (Do not use harsh or gritty cleaners.)

**Fill Hoses:** Hoses connecting washer to faucet should be replaced every 5 years.

**Exterior:** Immediately wipe off any spills. Wipe with damp cloth. Try not to hit surface with sharp objects.

**Moving and Storage:** Ask the service technician to remove water from drain pump and hoses. See the Installation Instructions packed with product for information on how to reinstall the shipping rod to keep the tub stationary when moving the washer. For more information, visit [www.GEAppliances.com](http://www.GEAppliances.com), or call **800.GE.CARES** (800.432.2737). Do not store the washer where it will be exposed to the weather.

**Long Vacations:** Be sure water supply is shut off at faucets. Drain all water from hoses if weather will be below freezing.



## Fabric Care Labels

Below are fabric care label "symbols" that affect the clothing you will be laundering.

### WASH LABELS

<i>Machine wash cycle</i>						
	Normal	Permanent Press/ wrinkle resistant	Gentle/ delicate	Hand wash	Do not wash	Do not wring
<i>Water temperature</i>						
	Hot (50°C/120°F)		Warm (40°C/105°F)		Cold/cool (30°C/85°F)	

### DRY LABELS

<i>Tumble dry</i>						
	Dry	Normal	Permanent Press/ wrinkle resistant	Gentle/ delicate	Do not tumble dry	Do not dry (used with do not wash)
<i>Heat setting</i>						
	High	Medium	Low	No heat/air		
<i>Special instructions</i>						
	Line dry/ hang to dry	Drip dry	Dry flat	In the shade		

### BLEACH LABELS

<i>Bleach symbols</i>			
	Any bleach (when needed)	Only non-chlorine bleach (when needed)	Do not bleach



## Troubleshooting Tips

Save time and money! Review the charts on the following pages, or visit [www.GEAppliances.com](http://www.GEAppliances.com). You may not need to call for service.

<b>PERFECTEMP PLUS</b>	<b>Possible Causes</b>	<b>What To Do</b>
<b>PerfectTemp Plus wash temperature is incorrect</b>	The washer is in a cold rinse cycle	<ul style="list-style-type: none"> <li>This is normal. The <b>PerfectTemp Plus</b> feature is designed not to activate during a cold rinse cycle to improve the energy efficiency of your washer.</li> </ul>
<b>(Review PerfectTemp Plus in the About washer features section)</b>	All the water in the household water heater has been used	<ul style="list-style-type: none"> <li>Wait until the water in the water heater is heated to the correct temperature.</li> </ul>
<b>PERFORMANCE</b>	<b>Possible Causes</b>	<b>What To Do</b>
<b>Clothes too wet</b>	Incorrect spin speed selected	<ul style="list-style-type: none"> <li>Make sure the spin cycle selected matches the load you are washing. Some fabrics will feel wetter when rinsed with cold water.</li> </ul>
<b>Colored spots</b>	Incorrect use of fabric softener	<ul style="list-style-type: none"> <li>Check fabric softener package for instructions and follow directions for using dispenser.</li> <li>Pretreat stain and rewash.</li> </ul>
	Dye transfer	<ul style="list-style-type: none"> <li>Sort whites or lightly colored items from dark colors.</li> </ul>
<b>Grayed or yellowed clothes</b>	Not enough detergent	<ul style="list-style-type: none"> <li>Use more detergent (especially with larger loads). Be sure to follow detergent manufacturer's directions.</li> </ul>
	Hard water	<ul style="list-style-type: none"> <li>Use a water conditioner like Calgon brand or install a water softener.</li> </ul>
	Water is not hot enough	<ul style="list-style-type: none"> <li>Make sure water heater is delivering water at 120°F–140°F (48°C–60°C).</li> </ul>
	Washer is overloaded	<ul style="list-style-type: none"> <li>Select load size to match clothes load.</li> </ul>
	Detergent is not dissolving	<ul style="list-style-type: none"> <li>Add detergent as wash basket fills with water before you load clothes.</li> </ul>
	Dye transfer	<ul style="list-style-type: none"> <li>Sort clothes by color. If fabric label states <i>wash separately</i>, unstable dyes may be indicated.</li> </ul>
<b>Lint or residue on clothes</b>	Clothes are air or line dried	<ul style="list-style-type: none"> <li>If you do not dry your clothes with a clothes dryer, your clothes may retain more lint.</li> </ul>
	Incorrect sorting	<ul style="list-style-type: none"> <li>Separate lint producers from lint collectors.</li> </ul>
	Washing too long	<ul style="list-style-type: none"> <li>Wash small loads for a shorter time than larger loads.</li> </ul>
	Detergent not dissolving	<ul style="list-style-type: none"> <li>Add detergent as wash basket fills with water, before you load clothes.</li> <li>Try a liquid detergent.</li> <li>Use warmer water temperature.</li> </ul>
	Overloading	<ul style="list-style-type: none"> <li>Load clothes no higher than the top row of holes in the washer basket.</li> <li>Make sure load size selected matches clothes load size.</li> </ul>
	Incorrect use of fabric softener	<ul style="list-style-type: none"> <li>Check fabric softener package for instructions and follow directions for using dispenser.</li> </ul>
	Wash speed is too fast	<ul style="list-style-type: none"> <li>Choose a wash cycle with a slower wash speed.</li> </ul>

## Before you call for service...

<i>PERFORMANCE (cont.)</i>	<i>Possible Causes</i>	<i>What To Do</i>
<b>Pilling</b>	Result of normal wear on poly-cotton blends and fuzzy fabrics	<ul style="list-style-type: none"> <li>While this is not caused by the washer, you can slow the pilling process by washing garments inside out.</li> </ul>
<b>Snags, holes, tears, rips or excessive wear</b>	Pins, snaps, hooks, sharp buttons, belt buckles, zippers and sharp objects left in pockets	<ul style="list-style-type: none"> <li>Fasten snaps, hooks, buttons and zippers.</li> <li>Remove loose items like pins, objects in pockets and sharp buttons.</li> <li>Turn knits (which snag easily) inside out.</li> </ul>
	Undiluted chlorine bleach	<ul style="list-style-type: none"> <li>Check bleach package instructions for proper amount.</li> <li>Never add undiluted bleach to wash or allow clothes to come in contact with undiluted bleach.</li> </ul>
	Chemicals like hair bleach or dye, permanent wave solution	<ul style="list-style-type: none"> <li>Rinse items that may have chemicals on them before washing.</li> </ul>
<b>Wrinkling</b>	Improper sorting	<ul style="list-style-type: none"> <li>Avoid mixing heavy items (like work clothes) with light items (like blouses).</li> <li>Try a fabric softener.</li> </ul>
	Overloading or incorrect water level	<ul style="list-style-type: none"> <li>Load your washer so clothes have enough room to move freely with water covering all of the clothes.</li> </ul>
	Incorrect wash and dry cycles	<ul style="list-style-type: none"> <li>Match Cycle selection to the type of fabric you are washing (especially for easy care loads).</li> </ul>
	Repeated washing in water that is too hot	<ul style="list-style-type: none"> <li>Wash in warm or cold water.</li> </ul>

<i>OPERATION</i>	<i>Possible Causes</i>	<i>What To Do</i>
<b>Washer pauses during wash cycle</b>	The <b>ULTRA HANDWASH, DELICATES</b> or <b>CASUALS</b> cycle was chosen	<ul style="list-style-type: none"> <li>This is normal. The washer alternates between agitate and soak during the <b>ULTRA HANDWASH, DELICATES</b> and <b>CASUALS</b> cycles to get your clothes cleaner with less wear.</li> </ul>
	The highest <b>SOIL LEVEL</b> setting was chosen	<ul style="list-style-type: none"> <li>The highest <b>SOIL LEVEL</b> setting adds a 15 minute Stain Wash agitate and soak period at the beginning of the wash cycle.</li> </ul>
<b>Washer pauses during spin cycle</b>	This is normal	<ul style="list-style-type: none"> <li>The washer may pause during the spin cycle to remove soapy water more efficiently.</li> </ul>
<b>Washer won't operate</b>	Control panel is asleep	<ul style="list-style-type: none"> <li>This is normal. Press <b>POWER</b> to activate the control panel.</li> </ul>
	Washer is unplugged	<ul style="list-style-type: none"> <li>Make sure cord is plugged securely into a working outlet.</li> </ul>
	Water supply is turned off	<ul style="list-style-type: none"> <li>Turn both hot and cold faucets fully on.</li> </ul>
	Controls are not set properly	<ul style="list-style-type: none"> <li>Check controls.</li> </ul>
	Lid is open—safety feature prevents agitation and spinning when lid is up.	<ul style="list-style-type: none"> <li>Close lid and reset cycle, to the beginning if necessary.</li> </ul>
	Circuit breaker/fuse is tripped/blown	<ul style="list-style-type: none"> <li>Check house circuit breakers/fuses. Replace fuses or reset breaker. Washer should have separate outlet.</li> </ul>
	Electronics need to be reset	<ul style="list-style-type: none"> <li>Unplug washer, wait 2 minutes, plug back in and press <b>POWER</b>.</li> </ul>

<b>OPERATION (cont.)</b>	<b>Possible Causes</b>	<b>What To Do</b>
<b>Washer won't operate</b>	START was not pressed	• Press <b>START</b> .
	Extremely low water pressure	• Press <b>START</b> again.
	Washer was accidentally paused when starting Delay Start	• If the light on the <b>DELAY START</b> pad is flashing, the washer is paused. Press <b>START</b> to restart the countdown.
<b>WATER</b>	<b>Possible Causes</b>	<b>What To Do</b>
<b>Too many suds</b>	Type of detergent	• Switch to a lower sudsing detergent brand and follow instructions on package.
	Very soft water	• Try less detergent.
	Too much detergent	• Measure your detergent carefully. Use less soap if you have soft water, a smaller load or a lightly soiled load.
<b>Water leaks</b>	Fill hoses or drain hose is improperly connected	<ul style="list-style-type: none"> <li>• Make sure hose connections are tight at faucets and at washer.</li> <li>• Make sure end of drain hose is properly connected to washer and correctly inserted in and secured to drain facility.</li> </ul>
	Household drain may be clogged	• Check household plumbing. You may need to call a plumber.
	Constant water pressure to the fill hoses at the water source	<ul style="list-style-type: none"> <li>• Tighten hoses at the faucets and turn the water off after each use.</li> <li>• Check condition of the fill hoses; they should be replaced every 5 years.</li> </ul>
	Using too much detergent in washer	• Use less detergent. Use less soap if you have soft water, a smaller load or a lightly soiled load.
<b>Water temperature seems incorrect</b>	Cooler water temperatures provide improved energy efficiency	• New laundry detergents have been formulated to work with cooler water temperatures without affecting wash performance.
	Control is not set properly	• Check water temperature control and adjust.
	Water supply is turned off or improperly connected	• Turn both hot and cold faucets fully on and make sure hoses are connected to correct faucets.
	Water valve screens are stopped up	• Turn off the water source and disconnect water fill hoses from the upper back of the washer. Use a brush or toothpick to clean the screens in the machine. Reconnect the hoses and turn the water back on.
	House water heater is not set properly	• Make sure house water heater is delivering water at 120°F–140°F (48°C–60°C).
	<b>PerfectTemp Plus</b> feature was not activated	• The lid must be closed for <b>PerfectTemp Plus</b> to work.
	Wash temperature was set to TAP COLD	• When the Tap Cold feature is selected, the water temperature may vary depending on the temperature of your household tap water.

## Before you call for service...

<b>WATER (cont.)</b>	<b>Possible Causes</b>	<b>What To Do</b>
<b>Water pumped out before cycle is complete</b>	Lid lifted or cycle was put in pause for over 24 hours	<ul style="list-style-type: none"> <li>Reset cycle.</li> </ul>
<b>Water won't drain</b>	Drain hose is kinked or improperly connected	<ul style="list-style-type: none"> <li>Straighten drain hose and make sure washer is not sitting on it.</li> <li>Top of drain outlet should be less than 8 ft (2.5 m) above floor.</li> </ul>
<b>Water spraying during spin cycle</b>	Washer in spin cycle	<ul style="list-style-type: none"> <li>Spray rinse during a spin cycle is normal.</li> </ul>

<b>Washer did not fill to chosen level</b>	Extremely low water pressure	<ul style="list-style-type: none"> <li>Press the <b>START</b> pad again.</li> </ul>
	Inlet hoses are kinked	<ul style="list-style-type: none"> <li>Straighten hoses.</li> </ul>
	Water valve screens are stopped up	<ul style="list-style-type: none"> <li>Turn off the water source and disconnect water fill hoses from the upper back of the washer. Use a brush or toothpick to clean the screens in the machine. Reconnect the hoses and turn the water back on.</li> </ul>
<b>Water fills and drains at the same time</b>	Drain stand pipe is too low	<ul style="list-style-type: none"> <li>Drain stand pipe must be above 30" (76.2 cm).</li> </ul>

<b>NOISE</b>	<b>Possible Causes</b>	<b>What To Do</b>
<b>Washer is noisy</b>	Washer is uneven	<ul style="list-style-type: none"> <li>To level the front of the washer, adjust the front leveling legs by rotating the individual leg in the proper direction for up or down. To level back of washer, lift back of machine 4" (11 cm) and set down.</li> </ul>
	Washer load is unbalanced	<ul style="list-style-type: none"> <li>Press <b>START</b> to pause the washer, open the lid and redistribute the load evenly. Close the lid and press <b>START</b> again.</li> </ul>
	Shipping rod is still assembled in unit	<ul style="list-style-type: none"> <li>To remove shipping rod from washer, pull yellow tag and attached rod from the bottom right hand side of washer.</li> </ul>
	Washer is sitting too close to wall (causes knocking during cycle)	<ul style="list-style-type: none"> <li>Pull washer away from the wall; about 4" (11 cm) is needed.</li> </ul>
	<b>PerfectTemp Plus</b> feature is being used	<ul style="list-style-type: none"> <li>This is normal. <b>PerfectTemp Plus</b> turns water valves off and on to adjust water temperature.</li> </ul>

<b>OTHER</b>	<b>Possible Causes</b>	<b>What To Do</b>
<b>Labels on the exterior of the washer will not peel off cleanly</b>	Occasionally the adhesive used on the labels does not release cleanly	<ul style="list-style-type: none"> <li>Use a hair dryer set at the lowest heat setting, directing the air at the label for a short amount of time. This will release the adhesive easily, without damaging the surface of the washer.</li> </ul>

# GE Washer Warranty.



All warranty service provided by our Factory Service Centers, or an authorized Customer Care® technician. To schedule service, on-line, 24 hours a day, visit us at [www.GEAppliances.com](http://www.GEAppliances.com), or call **800.GE.CARES** (800.432.2737).

Staple your receipt here.  
Proof of the original purchase date is needed to obtain service under the warranty.

## For The Period Of: We Will Replace:

<b>One Year</b> From the date of the original purchase	<b>Any part</b> of the washer which fails due to a defect in materials or workmanship. During this <b>full one-year warranty</b> , GE will also provide, <b>free of charge</b> , all labor and related service costs to replace the defective part.
<b>Second Year</b> From the date of the original purchase	<b>Any part</b> of the washer which fails due to a defect in materials or workmanship. During this <b>additional one-year limited warranty</b> , you will be responsible for any labor or related service costs.
<b>Third through Fifth Year</b> From the date of the original purchase	<b>The suspension rod and spring assembly, and main electronic control board</b> , if any of these parts should fail due to a defect in materials or workmanship. GE will also replace the <b>washer lid or cover</b> , if they should rust under operating conditions. During this <b>additional three-year limited warranty</b> , you will be responsible for any labor or related service costs.
<b>Third through Tenth Year</b> From the date of the original purchase	<b>The transmission and outer washer tub</b> , if any of these parts should fail due to a defect in materials or workmanship. During this <b>additional eight-year limited warranty</b> , you will be responsible for any labor or related service costs.
<b>Lifetime of Product</b> From the date of the original purchase	<b>The washer basket</b> , if it should fail due to a defect in materials or workmanship. During this <b>product lifetime limited warranty</b> , you will be responsible for any labor or related service costs.

## What Is Not Covered:

- Service trips to your home to teach you how to use the product.
- Improper installation, delivery or maintenance.
- Failure of the product if it is abused, misused, or used for other than the intended purpose or used commercially.
- Replacement of house fuses or resetting of circuit breakers.
- Damage to the product caused by accident, fire, floods or acts of God.
- Incidental or consequential damage caused by possible defects with this appliance.
- Damage caused after delivery.

This warranty is extended to the original purchaser and any succeeding owner for products purchased for home use within the USA. In Alaska, the warranty excludes the cost of shipping or service calls to your home.

Some states do not allow the exclusion or limitation of incidental or consequential damages. This warranty gives you specific legal rights, and you may also have other rights which vary from state to state. To know what your legal rights are, consult your local or state consumer affairs office or your state's Attorney General.

Warrantor: General Electric Company, Louisville, KY 40225

## Consumer Support.

---



### GE Appliances Website

[www.GEAppliances.com](http://www.GEAppliances.com)

Have a question or need assistance with your appliance? Try the GE Appliances Website 24 hours a day, any day of the year! For greater convenience and faster service, you can now download Owner's Manuals, order parts, catalogs, or even schedule service on-line. You can also "Ask Our Team of Experts™" your questions, and so much more...



### Schedule Service

[www.GEAppliances.com](http://www.GEAppliances.com)

Expert GE repair service is only one step away from your door. Get on-line and schedule your service at your convenience 24 hours any day of the year! Or call 800.GE.CARES (800.432.2737) during normal business hours.



### Real Life Design Studio

[www.GEAppliances.com](http://www.GEAppliances.com)

GE supports the Universal Design concept—products, services and environments that can be used by people of all ages, sizes and capabilities. We recognize the need to design for a wide range of physical and mental abilities and impairments. For details of GE's Universal Design applications, including kitchen design ideas for people with disabilities, check out our Website today. For the hearing impaired, please call 800.TDD.GEAC (800.833.4322).



### Extended Warranties

[www.GEAppliances.com](http://www.GEAppliances.com)

Purchase a GE extended warranty and learn about special discounts that are available while your warranty is still in effect. You can purchase it on-line anytime, or call 800.626.2224 during normal business hours. GE Consumer Home Services will still be there after your warranty expires.

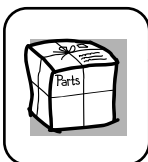

### Parts and Accessories

[www.GEAppliances.com](http://www.GEAppliances.com)

Individuals qualified to service their own appliances can have parts or accessories sent directly to their homes (VISA, MasterCard and Discover cards are accepted). Order on-line today, 24 hours every day or by phone at 800.626.2002 during normal business hours.

**Instructions contained in this manual cover procedures to be performed by any user. Other servicing generally should be referred to qualified service personnel. Caution must be exercised, since improper servicing may cause unsafe operation.**

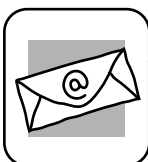

### Contact Us

[www.GEAppliances.com](http://www.GEAppliances.com)

If you are not satisfied with the service you receive from GE, contact us on our Website with all the details including your phone number, or write to: General Manager, Customer Relations  
GE Appliances, Appliance Park  
Louisville, KY 40225



### Register Your Appliance

[www.GEAppliances.com](http://www.GEAppliances.com)

Register your new appliance on-line—at your convenience! Timely product registration will allow for enhanced communication and prompt service under the terms of your warranty, should the need arise. You may also mail in the pre-printed registration card included in the packing material.