

This Owner's Manual is provided and hosted by Appliance Factory Parts.

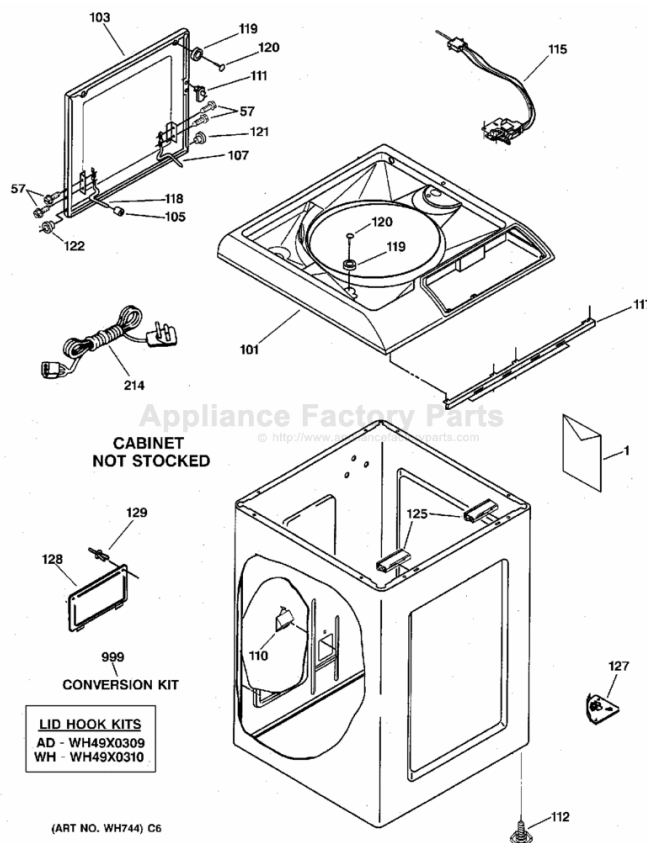

GE WSKS3040F0WW Owner's Manual

[Shop genuine replacement parts for GE
WSKS3040F0WW](#)



[Find Your GE Washer Parts - Select From 4591 Models](#)

----- Manual continues below -----



Washers

Safety Information 2, 3

Operating Instructions

Control Panel and Settings 4
Loading and Using the Washer 6, 7
Washer Features 5

Installation Instructions

Alcove or Closet Installation 13
Electrical Requirements 9
Grounding Instructions 9
Leveling the Washer 12
Preparation 8, 9
Washer Connections 10-13

Troubleshooting Tips

Before You Call For Service 14-16

Consumer Support

Consumer Support Back Cover
Product Registration 17, 18
Warranty 19

**Owner's Manual &
Installation Instructions**

WSKS3040

Write the model and serial numbers here:

You can find them on a label on the back of the washer.



IMPORTANT SAFETY INFORMATION. READ ALL INSTRUCTIONS BEFORE USING.

⚠ WARNING! For your safety, the information in this manual must be followed to minimize the risk of fire or explosion, electric shock, or to prevent property damage, personal injury, or loss of life.



WATER HEATER SAFETY

Under certain conditions, hydrogen gas may be produced in a water heater that has not been used for two weeks or more. Hydrogen gas can be explosive under these circumstances.

If the hot water has not been used for two weeks or more, prevent the possibility of damage or injury by turning on all hot water faucets and allowing them to run for several minutes. Do this before using any electrical appliance which is connected to the hot water system. This simple procedure will allow any built-up hydrogen gas to escape. Since the gas is flammable, do not smoke or use an open flame or appliance during this process.

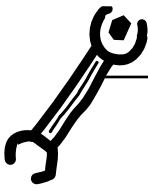

PROPER INSTALLATION

This washer must be properly installed and located in accordance with the Installation Instructions before it is used.

- Install or store where it will not be exposed to temperatures below freezing or exposed to the weather.
- Properly ground washer to conform with all governing codes and ordinances. Follow details in Installation Instructions.



YOUR LAUNDRY AREA

- Keep the area underneath and around your appliances free of combustible materials such as lint, paper, rags, chemicals, etc.
- Close supervision is necessary if this appliance is used by or near children. Do not allow children to play on, with or inside this or any other appliance.



WHEN USING THE WASHER

Use this appliance only for its intended purpose as described in this Owner's Manual.

- Never reach into washer while it is moving. Wait until the machine has completely stopped before opening the lid.
- Do not use sharp objects around the control panel. They may damage it.
- Do not mix chlorine bleach with ammonia or acids such as vinegar and/or rust remover. Mixing different chemicals can produce a toxic gas which may cause death.
- Do not wash or dry articles that have been cleaned in, washed in, soaked in or spotted with combustible or explosive substances (such as wax, oil, paint, gasoline, degreasers, dry-cleaning solvents, kerosene, etc.). These substances give off vapors that may ignite or explode. Do not add these substances to the wash water. Do not use or place these substances around your washer or dryer during operation.
- The laundry process can reduce the flame retardancy of fabrics. To avoid such a result, carefully follow the garment manufacturer's wash and care instructions.
- To minimize the possibility of electric shock, unplug this appliance from the power supply or disconnect the washer at the household distribution panel by removing the fuse or switching off the circuit breaker before attempting any maintenance or cleaning. **NOTE:** Turning the washer off does **NOT** disconnect the appliance from the power supply.
- Never attempt to operate this appliance if it is damaged, malfunctioning, partially disassembled, or has missing or broken parts, including a damaged cord or plug.



WHEN NOT IN USE

- Turn off water faucets to relieve pressure on hoses and valves and to minimize leakage if a break or rupture should occur. Check the condition of the fill hoses; they may need replacement after 5 years.
- Before discarding a washer, or removing it from service, remove the washer lid to prevent children from hiding inside.
- Do not attempt to repair or replace any part of this appliance unless specifically recommended in this Owner's Manual, or in published user-repair instructions that you understand and have the skills to carry out.
- Do not tamper with controls.



READ AND FOLLOW THIS SAFETY INFORMATION CAREFULLY.

SAVE THESE INSTRUCTIONS

About the washer control panel.

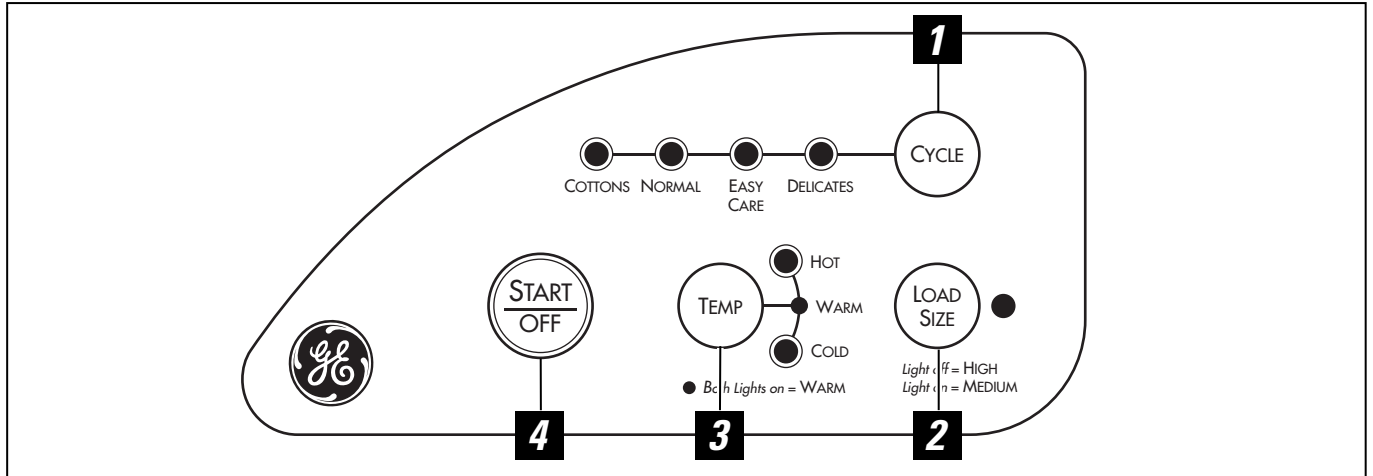

About the control settings.

1 WASH CYCLE

These wash cycles control the length of the washing process.

COTTONS Use this cycle to get 18 minutes of wash time for sturdy or heavily soiled loads. Wash combines high-speed agitation and high-speed spin for maximum soil removal.

NORMAL Use this cycle to get 12 minutes of wash time for normally soiled cottons and linens. Wash combines medium-speed agitation and high-speed spin to shorten drying time.

EASY CARE Use this cycle to get 10 minutes of wash time. Use for wrinkle-free and permanent press items and knits. Wash combines medium-speed agitation and high speed spin to shorten drying time.

DELICATES Use this cycle to get 6 minutes of wash time for lingerie and loosely knit items. Wash combines a low-speed agitation for gentle soil removal and high-speed spin to shorten drying time.

2 LOAD SIZE

Loosely load clothes no higher than the top row of holes in the washer basket. The water level should just cover the clothes. Adjust the load size accordingly. Press the **LOAD SIZE** button to select the correct setting for your wash load and type of fabric being washed. For a medium load, the indicator light is on; for a large load, the light is off.

3 TEMP

Select the water temperature for the wash and rinse cycles. Always follow fabric manufacturer's care label or instructions when laundering. All cycles use a cold rinse.

4 START/OFF

Press the **START/OFF** button to start the wash cycle.

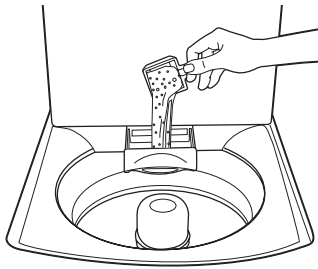

Detergent Dispenser Drawer

The detergent dispenser will automatically release its contents at the proper time during the cycle.

Add measured detergent to the dispenser. Make sure detergent is spread evenly and is level.

NOTE: Liquid detergent can be poured in the bottom of the washer tub.

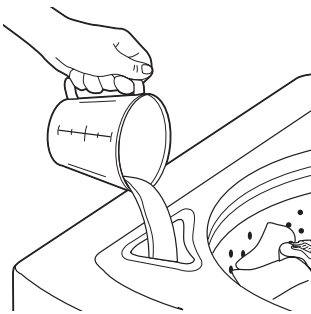

Liquid Bleach Dispenser

The dispenser dilutes liquid chlorine bleach before it reaches into your wash load.

- 1 Check clothing care labels for special instructions.
 - 2 Measure liquid bleach carefully, following instructions on the bottle.
- **Never pour undiluted liquid chlorine bleach directly onto clothes or into the wash basket.**
 - **Do not pour powdered bleach into bleach dispenser.**

- 3 Before starting the washer, pour measured amount of bleach directly into bleach dispenser. Avoid splashing or over-filling dispenser. If you prefer to use powdered bleach, add it into the wash basket with your detergent.

■ **Do not mix chlorine bleach with ammonia or acids such as vinegar and/or rust remover. Mixing can produce a toxic gas which may cause death.**

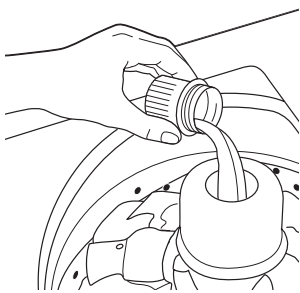

Fabric Softener Dispenser

The fabric softener dispenser automatically releases liquid fabric softener at the proper time during the cycle.

- **Do not stop the washer during the first spin. This will cause the dispenser to empty too soon.**

To use, follow these steps:

- 1 Use only liquid fabric softener. Pour into dispenser, using amount recommended on package.
- **Never pour fabric softener directly on clothes. It may stain them.**
- 2 Add water to dispenser until it reaches the maximum fill line.

Cleaning the Fabric Softener Dispenser

Flush fabric softener dispenser periodically with warm water.

- 1 Grasp the top of the dispenser and pull upward to remove.
- 2 Flush the dispenser with warm water. Replace after cleaning.

NOTE: To avoid damage to the washer or clothing, do not wash clothes with the fabric softener dispenser removed. Do not add detergent or bleach to this dispenser; it is for fabric softener only.

Cleaning the Lint Filter

Flush filter after every load.

- 1 Grasp the top of the fabric softener dispenser and pull straight upward to remove. The lint filter is attached at the end of the shaft.
- 2 Wash or wipe the lint filter clean.

- 3 Push fabric softener dispenser and lint filter firmly back into agitator.

Loading and using the washer.

Always follow fabric manufacturer's care label when laundering.



Sorting Wash Loads

Sort by color (whites, lights, colors), soil level, fabric type (sturdy cottons, easy care, delicates) and whether the fabric produces lint (terry cloth, chenille) or collects lint (velveteen, corduroy).

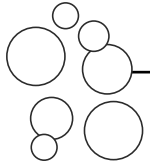

Proper Use of Detergent

Add clothes and detergent, then start the washer. Using too little or too much detergent is a common cause of laundry problems.

You can use less detergent if you have soft water, a smaller load or a lightly soiled load.



Loading the Washer

Load dry items loosely, no higher than the top row of holes in the washer basket. When loading wet items, make sure you set the load/water level high enough to allow the items to move freely. Water level should just cover the clothes. To add items after washer has started, open the lid and add the additional items. Close the lid. Washer will start automatically.

- Do not wrap large items like sheets around the agitator.
- Do not wash fabrics containing flammable materials (waxes, cleaning fluids, etc.).



Care and Cleaning of the Washer

Wash Basket: Leave the lid open after washing to allow moisture to evaporate. If you want to clean the basket, use a clean soft cloth dampened with liquid detergent, then rinse. (Do not use harsh or gritty cleaners.)

Fill Hoses: Hoses connecting washer to faucet should be replaced every 5 years.

Exterior: Immediately wipe off any spills. Wipe with damp cloth. Try not to hit surface with sharp objects.

Moving and Storage: Ask the service technician to remove water from drain pump and hoses. Do not store the washer where it will be exposed to the weather.

Long Vacations: Be sure water supply is shut off at faucets. Drain all water from hoses if weather will be below freezing.

Loading and using the washer.



Fabric Care Labels

Below are fabric care label “symbols” that affect the clothing you will be laundering.

WASH LABELS

<i>Machine wash cycle</i>						
	Normal	Permanent Press/ wrinkle resistant	Gentle/ delicate	Hand wash	Do not wash	Do not wring
<i>Water temperature</i>						
	Hot (50°C/120°F)		Warm (40°C/105°F)		Cold/cool (30°C/85°F)	

DRY LABELS

<i>Tumble dry</i>						
	Dry	Normal	Permanent Press/ wrinkle resistant	Gentle/ delicate	Do not tumble dry	Do not dry (used with do not wash)
<i>Heat setting</i>						
	High	Medium	Low	No heat/air		
<i>Special instructions</i>						
	Line dry/ hang to dry	Drip dry	Dry flat	In the shade		

BLEACH LABELS

<i>Bleach symbols</i>			
	Any bleach (when needed)	Only non-chlorine bleach (when needed)	Do not bleach

Installation Instructions

Washer

WSKS3040

If you have questions, call 800.GE.CARES or visit our Website at: ge.com

BEFORE YOU BEGIN

Read these instructions completely and carefully.

- **IMPORTANT** — Save these instructions for local inspector's use.
- **IMPORTANT** — Observe all governing codes and ordinances.
- **Note to Installer** — Be sure to leave these instructions with the Consumer.
- **Note to Consumer** — Keep these instructions for future reference.
- **Skill level** — Installation of this appliance requires basic mechanical skills.
- **Completion time** — 1 hour
- Proper installation is the responsibility of the installer.
- Product failure due to improper installation is not covered under the Warranty.
- **Note** — This appliance must be properly grounded, and electrical service to the washer must conform with local codes and ordinances and the latest edition of the National Electrical Code, ANSI/NFPA 70.

WASHER LOCATION

Washer must be installed on firm flooring to minimize vibration during spin cycles. Concrete flooring is best, but wood base is sufficient providing floor support meets FHA standards. Washer should not be installed on rugs or exposed to the weather.

Install or store where it will not be exposed to temperatures below freezing or exposed to the weather.

ELECTRICAL

This appliance must be supplied with the voltage and frequency indicated on the rating plate (located on the back of the washer), and connected to an individual, properly grounded branch circuit, protected by a 15 or 20 amp circuit breaker or time-delay fuse.

If the washer is plugged into the dryer's 115 volt outlet, then the dryer needs to be on a dedicated circuit.

PLUMBING

- **WATER PRESSURE**—Must be 10 p.s.i. minimum to 150 p.s.i. maximum dynamic pressure measured at faucet.
- **WATER TEMPERATURE**—Household water heater should be set to deliver water at 120° to 150°F (50° to 66°C) IN THE WASHER when HOT wash is selected.
- **SHUT-OFF VALVES**—Both hot and cold shut-off valves (faucets) should be supplied.
- **DRAIN**—Water may be drained into a standpipe or set tub. The discharge height **MUST NOT BE LESS THAN 39" (99 cm)** nor more than 6' (183 cm) above the base of the washer. The standpipe must be 2" (5 cm) minimum inside diameter and must be open to the atmosphere.

RACK INSTALLATION

- Ensure washer is centered between the rack sides.

PARTS SUPPLIED



- Water Hoses (2)

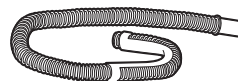

- Drain Hose



- Beaded Tie Strap



- Silver, double-wire hose clamp (for the bottom of the drain hose)



- Yellow, single-wire hose clamp (for the top of the drain hose)



- Rubber Washers (4)

TOOLS REQUIRED

- Pliers that open to 1 9/16" (3.95 cm)
- Adjustable or 9/16" (14 mm) open-end wrench
- Level
- Utility knife
- Wood block
- Measuring tape

Installation Instructions

ADDITIONAL PARTS YOU MAY NEED

Your installation may require additional parts. For ordering information, please refer to the consumer support section in this manual.

If you have:

Laundry tub or standpipe taller than 72"

Overhead sewer

Water faucet beyond reach of fill hoses

Drain hose too short

You will need to purchase:

- Sump pump system

- Standard 20 gallon (76L) 39" (99 cm) tall drain tub or utility sink

- Sump pump

- Connectors (available from local plumbing supplier)

- Two longer water fill hoses

- Drain hose

GROUNDING INSTRUCTIONS (cont.)

▲ DANGER: Improper connection of the equipment-grounding conductor can result in a risk of electrical shock. Check with a qualified electrician if you are in doubt as to whether the appliance is properly grounded.

Do not modify the plug with this appliance; if it will not fit the outlet installed, have a proper outlet installed by a qualified electrician.

REMOVE SHIPPING MATERIAL

Before you install your washer, remove all shipping material.

▲ WARNING: Excessive Weight Hazard— Use two or more people to move and install the washer. Failure to do so can result in back or other personal injury.

- To protect the floor, place two corner posts from the shipping material on the floor in back of the washer.
- Firmly grasp the body of the washer and gently lay it on the corner posts.
- Remove plastic foam packaging from under the washer.
- Use an adjustable wrench to turn the washer legs out approximately 3/4" (1.9 cm). This is the recommended setting. Later adjustment may be needed.

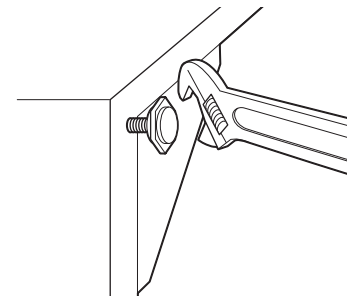

- Stand the washer up.
- Remove tape from the washer lid. Open the washer lid and remove foam shipping piece, parts bag and hoses from the washer basket. Remove tags from dispenser drawer. Close the lid.

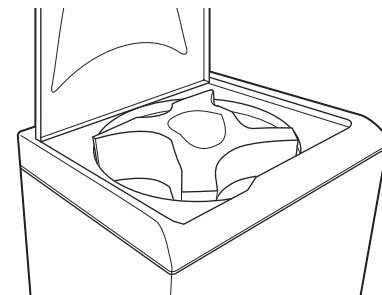

ELECTRICAL REQUIREMENTS

▲ CAUTION: For personal safety, do not use an extension cord or adapter plug with this appliance.

Do not, under any circumstances, cut or remove the third grounding prong from the power cord. Follow National Electrical Codes or prevailing local codes and ordinances.

This appliance must be supplied with the voltage and frequency indicated on the rating plate (located on the back of the washer), and connected to an individual, properly grounded branch circuit, protected by a 15 or 20 amp circuit breaker or time-delay fuse.

If the electric supply provided does not meet the above requirements, call a licensed electrician.

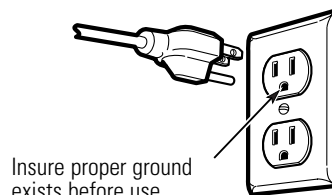

GROUNDING INSTRUCTIONS

This appliance must be grounded. In the event of a malfunction or breakdown, grounding will reduce the risk of electric shock by providing a path of least resistance for electrical current.

This appliance is equipped with a cord having an equipment grounding conductor and a grounding plug.

The plug must be plugged into an appropriate outlet that is properly installed and grounded in accordance with all local codes and ordinances.

Installation Instructions

WASHER CONNECTIONS

▲ WARNING: Make sure the washer is unplugged.

1 DRAIN SYSTEM

The washer can be installed using the standpipe drain system (floor to wall) or the laundry tub drain system. Select the drain hose installation method you need.

Standpipe drain system—wall to floor

The standpipe drain requires a minimum diameter standpipe of 2" (5 cm). The minimum carry-away capacity can be no less than 13 gallons (49.2L) per minute.

The top of the standpipe must be at least 39" (99 cm) high and no higher than 72" (183 cm) from the bottom of the washer.

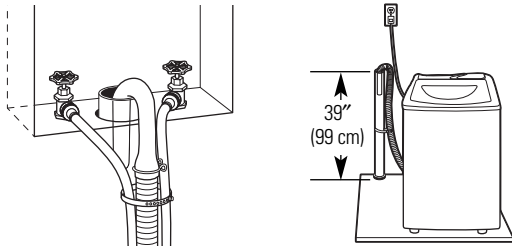

Laundry tub drain system

The laundry tub requires a minimum carry-away capacity of 13 gallons (49.2L) per minute.

The top of the laundry tub must be at least 39" (99 cm) above the floor and no higher than 72" (183 cm) from the bottom of the washer.

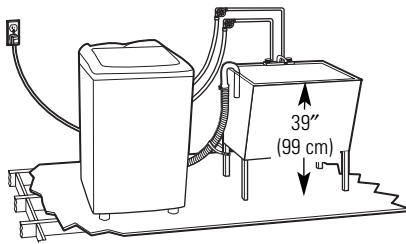

2 CONNECT DRAIN HOSE

Proper connection of the drain hose will protect your floors from damage due to water leakage. To prevent the drain hose from coming off or leaking, it must be installed according to the following instructions.

IMPORTANT: To ensure proper installation, this procedure must be followed exactly.

- Check the drain hose to see that it is the proper length.
- Wet the inside of the straight end of the drain hose with tap water.

IMPORTANT: Do not use any lubricant other than water.

- Squeeze ears of double-wire clamp with pliers to open. Place clamp over the straight end of the drain hose 1/4" (6 mm) from the end. Twist hose back and forth while pushing down onto drain connector at the bottom of the washer. Continue until hose contacts the cabinet.

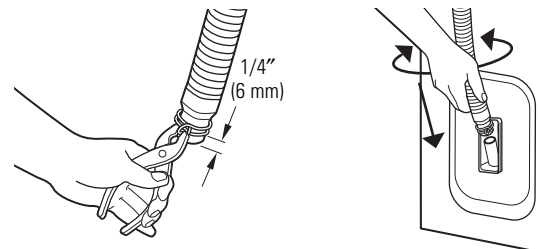

- Place clamp over area marked "CLAMP". Release clamp.

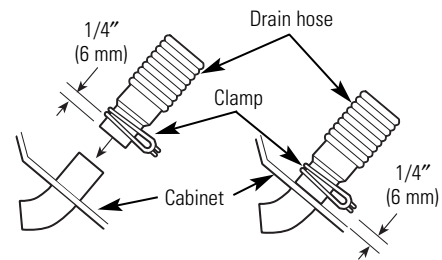

Installation Instructions

2 CONNECT DRAIN HOSE (cont.)

For standpipe or laundry tub drain systems:

- Open yellow, single-wire clamp with pliers and slide over hooked end of drain hose to secure the rubber and corrugated sections together.

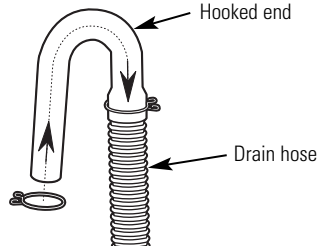

- Put hooked end of drain hose into laundry tub or standpipe. Rotate hook to eliminate kinks in the hose.

To prevent drain water from going back into the washer:

- Do not straighten hooked end of drain hose. Do not force excess drain hose into standpipe. Hose should be secure, but loose enough to provide a gap of air.
- Do not lay excess drain hose in bottom of laundry tub.

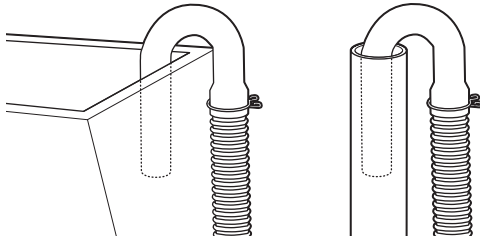

3 CONNECT INLET HOSES

- Insert new flat washers (supplied) into each end of the inlet hoses. Firmly seat the washers in the couplings.

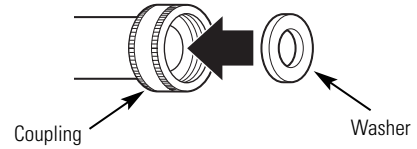

Connect the inlet hoses to the water faucets

Make sure the washer basket is empty.

- Attach the hose with the red coupling to the hot water faucet. Screw on coupling by hand until seated on the washer.
- Attach the hose with the blue coupling to the cold water faucet. Screw on coupling by hand until seated on the washer.
- Using pliers, tighten the couplings with an additional two-thirds turn.

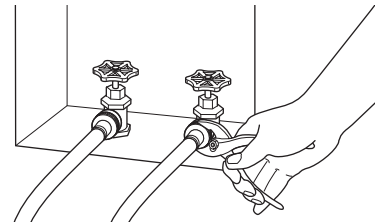

NOTE: Do not overtighten. Damage to the valves can result.

Clear the water lines

- Run water through both faucets and inlet hoses, into a bucket or laundry tub, to get rid of particles in the water lines that might clog the inlet valve screens.

Installation Instructions

WASHER CONNECTIONS

3 CONNECT INLET HOSES (cont.)

Connect the inlet hoses to the washer

- Attach the hose with the red coupling to the HOT (right) inlet valve. Attaching the red coupling first makes it easier to tighten connection with pliers. Screw on coupling by hand until it is seated on the washer. Using pliers, tighten the coupling with an additional two-thirds turn.

NOTE: Do not overtighten. Damage to the valves can result.

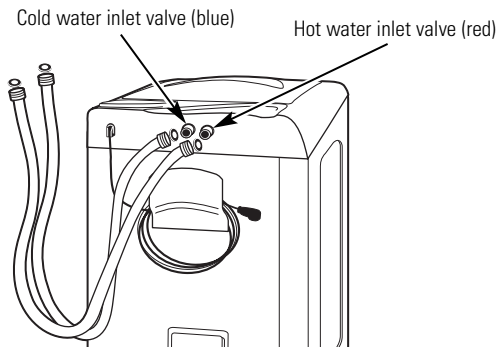

- Attach the hose with the blue coupling to the COLD water (left) inlet valve. Screw on coupling by hand until it is seated on the washer. Using pliers, tighten the coupling with an additional two-thirds turn.

NOTE: Do not overtighten. Damage to the valves can result.

4 CHECK FOR LEAKS

- Turn on the water faucets and check for leaks. A small amount of water might enter the washer. You will drain this later.

NOTE: Replace inlet hoses after 5 years of use to reduce the risk of hose failure. Record hose installation or replacement dates for future reference.

- If you connect only one water hose, you must cap off the remaining water inlet port.
- Periodically inspect and replace hoses if bulges, kinks, cuts, wear or leaks are found.

5 SECURE DRAIN HOSE

- Drape the power cord over the console.
- Move the washer to its final location and remove any cardboard used to move washer.
- Locate the beaded tie strap (supplied).

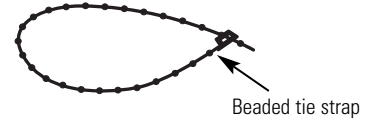

- Wrap the drain hose to the laundry tub leg or standpipe with the tie strap, as shown below.

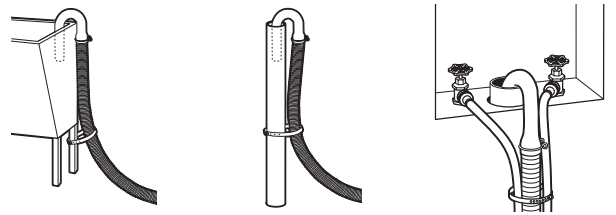

If the washer faucets and the drain standpipe are recessed, put the hooked end of the drain hose in the standpipe (see above illustration, at right). Tightly wrap the tie strap around the water inlet hoses and the drain hose.

- Do not force excess drain hose back into the rear of the washer.

6 LEVEL THE WASHER

Properly leveling your washer prevents excessive noise and vibration.

- Move washer to final location.
- Check that the washer is level from side to side and front to back by lining up the level as shown in the following illustrations.



- If the washer is not level, prop up the front of the washer with a wood block and adjust the feet up or down as necessary. If the washer is against a wall, move the washer out slightly before tipping back. Repeat this step until washer is level.

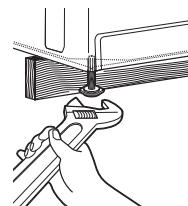

Installation Instructions

7 PLUG THE POWER CORD INTO A GROUNDED OUTLET

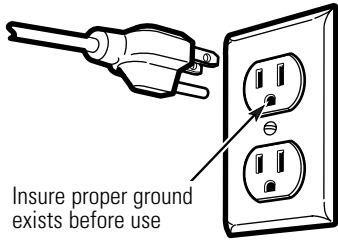

Insure proper ground exists before use

8 INSTALLATION CHECKLIST

Before starting the washer, check to make sure:

- Main power is turned on.
- The washer is plugged in.
- The water faucets are turned on.
- The unit is level.
- The drain hose is properly tied up.
- There are no leaks at the faucet, drain line or washer.

9 RUN THE WASHER THROUGH A COMPLETE CYCLE

Check for water leaks and proper operation.

10 REMOVE THE PROTECTIVE FILM COVERING THE CONTROL PANEL

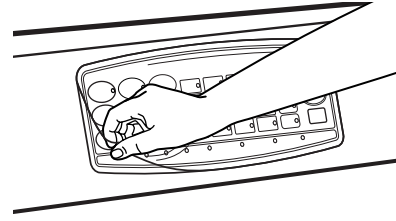

11 READ THE REST OF THIS OWNER'S MANUAL

It contains valuable and helpful information that will save you time and money.

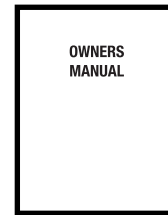

NOTE: If your washer does not operate, please review the *Before You Call For Service* section.

ALCOVE OR CLOSET INSTALLATION

If your washer is approved for installation in an alcove or closet, there will be a label on the back of the machine describing requirements.

- Minimum clearances between washer and adjacent walls or other surfaces are: 0" (0 cm) either side, 1" (2.5 cm) front, 4" (10.2 cm) rear.
- Minimum vertical space from top of washer to overhead shelves, cabinets, ceilings, etc. is 17" (43.2 cm).
- Closet doors must be louvered or otherwise ventilated and have at least 72 square inches open area for washer only, or if the closet contains both a washer and dryer, doors must contain at least 144 square inches of open area equally distributed.

NOTE: The clearances stated on this label are minimums. Consideration must be given to providing adequate clearances for installation and servicing.

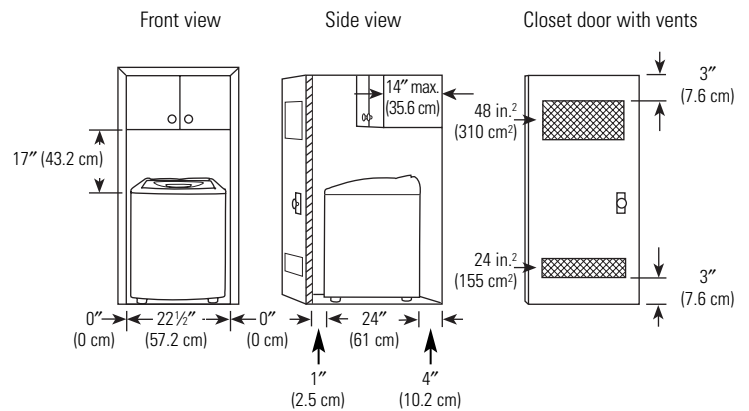

Before you call for service...



Troubleshooting Tips

Save time and money! Review the charts on the following pages first and you may not need to call for service.

WATER	POSSIBLE CAUSES	WHAT TO DO
Too many suds	Type of detergent	<ul style="list-style-type: none"> Switch to a lower sudsing detergent brand and follow instructions on package.
	Very soft water	<ul style="list-style-type: none"> Try less detergent.
	Too much detergent	<ul style="list-style-type: none"> Measure your detergent carefully. Use less soap if you have soft water, a smaller load or a lightly soiled load.
Water leaks	Fill hoses or drain hose is improperly connected	<ul style="list-style-type: none"> Make sure hose connections are tight at faucets and the washing machine. Make sure the end of the drain hose is correctly inserted in and secured to the drain.
	Household drain may be clogged	<ul style="list-style-type: none"> Check household plumbing. You may need to call a plumber.
	Constant water pressure to the fill hoses at the water source	<ul style="list-style-type: none"> Tighten hoses at the faucets and turn the water off after each use. Check condition of the fill hoses; they may need replacement after 5 years.
	Using too much detergent in washer	<ul style="list-style-type: none"> Use less detergent. Use less soap if you have soft water, a smaller load or a lightly soiled load.
Water temperature seems incorrect	Cooler water temperatures provide improved energy efficiency	<ul style="list-style-type: none"> New laundry detergents have been formulated to work with cooler water temperatures without affecting wash performance.
	Control is not set properly	<ul style="list-style-type: none"> Check water temperature control and adjust.
	Water supply is turned off or improperly connected	<ul style="list-style-type: none"> Turn both hot and cold faucets fully on and make sure hoses are connected to correct faucets.
	Water valve screens are stopped up	<ul style="list-style-type: none"> Turn off the water source and remove the water connection hoses from the upper back of the washer. Remove screens and use a brush or toothpick to clean the screens in the machine. Reinstall screens, reconnect the hoses and turn the water back on.
	House water heater is not set properly	<ul style="list-style-type: none"> Make sure house water heater is delivering water at 120°F–140°F (48°C–60°C).
Water won't drain	Drain hose is kinked or improperly connected	<ul style="list-style-type: none"> Straighten drain hose and make sure washer is not sitting on it. Top of drain outlet should be less than 72" (183 cm) above floor.
Water fills and drains at the same time	Drain standpipe is too low	<ul style="list-style-type: none"> Drain standpipe must be above 39" (99 cm).

OPERATION	POSSIBLE CAUSES	WHAT TO DO
Washer pauses during wash cycle	The washer normally pauses between washing steps	
Washer pauses during spin cycle	This is normal	<ul style="list-style-type: none"> The washer may pause during the spin cycle to remove soapy water more efficiently.
Washer won't operate	Washer is unplugged	<ul style="list-style-type: none"> Make sure cord is plugged securely into a working outlet.
	Water supply is turned off	<ul style="list-style-type: none"> Turn both hot and cold faucets fully on.
	Controls are not set properly	<ul style="list-style-type: none"> Make sure all selections have been made.
	Lid is open	<ul style="list-style-type: none"> Close lid and press START/OFF.
	Circuit breaker/fuse is tripped/blown	<ul style="list-style-type: none"> Check house circuit breakers/fuses. Replace fuses or reset breaker. Washer should have separate outlet.
	Washer has not been turned on	<ul style="list-style-type: none"> Press the START/OFF button.
PERFORMANCE	POSSIBLE CAUSES	WHAT TO DO
Colored spots	Incorrect use of fabric softener	<ul style="list-style-type: none"> Check fabric softener package for instructions and follow directions for using dispenser. Pretreat stain and rewash.
	Dye transfer	<ul style="list-style-type: none"> Sort whites or lightly colored items from dark colors.
Grayed or yellowed clothes	Not enough detergent	<ul style="list-style-type: none"> Use more detergent (especially with larger loads). Be sure to follow detergent manufacturer's directions.
	Hard water	<ul style="list-style-type: none"> Use a water conditioner like Calgon brand or install a water softener.
	Water is not hot enough	<ul style="list-style-type: none"> Make sure water heater is delivering water at 120°F–140°F (48°C–60°C).
	Washer is overloaded	<ul style="list-style-type: none"> Select load size to match clothes load.
	Dye transfer	<ul style="list-style-type: none"> Sort clothes by color. If fabric label states <i>wash separately</i>, unstable dyes may be indicated.
Lint or residue on clothes	Clothes are air or line dried	<ul style="list-style-type: none"> If you do not dry your clothes with a clothes dryer, your clothes may retain more lint.
	Incorrect sorting	<ul style="list-style-type: none"> Separate lint producers from lint collectors.
	Washing too long	<ul style="list-style-type: none"> Wash small loads for a shorter time than larger loads.
	Overloading	<ul style="list-style-type: none"> Load clothes no higher than the top row of holes in the washer basket. Make sure load size selected matches clothes load size.
	Incorrect use of fabric softener	<ul style="list-style-type: none"> Check fabric softener package for instructions and follow directions for using dispenser.
Pilling	Result of normal wear on poly-cotton blends and fuzzy fabrics	<ul style="list-style-type: none"> While this is not caused by the washer, you can slow the pilling process by washing garments inside out.

Before you call for service...



Troubleshooting Tips

PERFORMANCE (cont'd)	POSSIBLE CAUSES	WHAT TO DO
Snags, holes, tears, rips or excessive wear	Pins, snaps, hooks, sharp buttons, belt buckles, zippers and sharp objects left in pockets	<ul style="list-style-type: none"> • Fasten snaps, hooks, buttons and zippers. • Remove loose items like pins, objects in pockets and sharp buttons. • Turn knits (which snag easily) inside out.
	Undiluted chlorine bleach	<ul style="list-style-type: none"> • Check bleach package instructions for proper amount. • Never add undiluted bleach to wash or allow clothes to come in contact with undiluted bleach.
	Chemicals like hair bleach or dye, permanent wave solution	<ul style="list-style-type: none"> • Rinse items that may have chemicals on them before washing.
Wrinkling	Improper sorting	<ul style="list-style-type: none"> • Avoid mixing heavy items (like work clothes) with light items (like blouses). • Try a fabric softener.
	Overloading or incorrect water level	<ul style="list-style-type: none"> • Load your washer so clothes have enough room to move freely with water covering all of the clothes.
	Repeated washing in water that is too hot	<ul style="list-style-type: none"> • Wash in warm or cold water.
NOISE	POSSIBLE CAUSES	WHAT TO DO
Washer is noisy	Washer is uneven	<ul style="list-style-type: none"> • Level the washer. See <i>Level the Washer</i>.
	Washer load is unbalanced	<ul style="list-style-type: none"> • Press the START/OFF button to stop the washer, open the lid and redistribute the load evenly. Close the lid and restart.
	Washer is sitting too close to wall (causes knocking during cycle)	<ul style="list-style-type: none"> • Pull washer away from the wall; about 4" is needed.
OTHER	POSSIBLE CAUSES	WHAT TO DO
Labels on the exterior of the washer will not peel off cleanly	Occasionally the adhesive used on the labels does not release cleanly	<ul style="list-style-type: none"> • Use a hair dryer set at the lowest heat setting, directing the air at the label for a short amount of time. This will release the adhesive easily, without damaging the surface of the washer.

GE Service Protection Plus™

GE, a name recognized worldwide for quality and dependability, offers you Service Protection Plus™—comprehensive protection on all your appliances—**No Matter What Brand!**

Benefits Include:

- Backed by GE
- All brands covered
- Unlimited service calls
- All parts and labor costs included
- No out-of-pocket expenses
- No hidden deductibles
- One 800 number to call

***We'll Cover Any Appliance.
Anywhere. Anytime.****

You will be completely satisfied with our service protection or you may request your money back on the remaining value of your contract. No questions asked. It's that simple.

Protect your refrigerator, dishwasher, washer and dryer, range, TV, VCR and much more—**any brand!** Plus there's no extra charge for emergency service and low monthly financing is available. Even icemaker coverage and food spoilage protection is offered. You can rest easy, knowing that all your valuable household products are protected against expensive repairs.

Place your confidence in GE and call us in the U.S. toll-free at **800.626.2224** for more information.

*All brands covered, up to 20 years old, in the continental U.S.

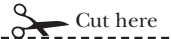

Please place in envelope and mail to:

General Electric Company
Warranty Registration Department
P.O. Box 32150
Louisville, KY 40232-2150

Consumer Product Ownership Registration

Dear Customer:

Thank you for purchasing our product and thank you for placing your confidence in us.

We are proud to have you as a customer!

Follow these three steps to protect your new appliance investment:

1

Complete and mail your Consumer Product Ownership Registration today. Have the peace of mind of knowing we can contact you in the unlikely event of a safety modification.

2

After mailing the registration below, store this document in a safe place. It contains information you will need should you require service. Our service number is 800.GE.CARES (800.432.2737).

3

Read your Owner's Manual carefully. It will help you operate your new appliance properly.

Model Number

Serial Number

Important: If you did not get a registration card with your product, detach and return the form below to ensure that your product is registered, or register online at ge.com.

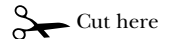

Consumer Product Ownership Registration



Model Number

Serial Number

Mr. Ms. Mrs. Miss

First Name

Last Name

Street Address

Apt. #

E-mail Address

City

State

Zip Code

Date Placed In Use
Month

Day

Year

Phone Number - -



GE Appliances

GE Consumer & Industrial
Louisville, Kentucky
www.GEAppliances.com

* Please provide your e-mail address to receive, via e-mail, discounts, special offers and other important communications from GE Appliances (GEA).

Check here if you do not want to receive communications from GEA's carefully selected partners.

FAILURE TO COMPLETE AND RETURN THIS CARD DOES NOT DIMINISH YOUR WARRANTY RIGHTS.

For information about GEA's privacy and data usage policy, go to ge.com and click on "Privacy Policy" or call 800.626.2224.

GE Washer Warranty.



All warranty service provided by our Factory Service Centers, or an authorized Customer Care[®] technician. To schedule service, on-line, 24 hours a day, visit us at ge.com, or call 800.GE.CARES (800.432.2737). Please have serial number and model number available when calling for service.

Staple your receipt here.
Proof of the original purchase date is needed to obtain service under the warranty.

For The Period Of: We Will Replace:

One Year

From the date of the original purchase

Any part of the washer which fails due to a defect in materials or workmanship. During this **limited one-year warranty**, we will also provide, **free of charge**, all labor and related service to replace the defective part.

What Is Not Covered:

- Service trips to your home to teach you how to use the product.
- Improper installation, delivery or maintenance.
- Failure of the product if it is abused, misused, or used for other than the intended purpose or used commercially.
- Replacement of house fuses or resetting of circuit breakers.
- Products which are not defective or broken, or which are working as described in the Owner's Manual.
- Damage to the product caused by accident, fire, floods or acts of God.
- Incidental or consequential damage caused by possible defects with this appliance.
- Defects or damage due to operation in freezing temperatures.
- Damage caused after delivery.
- Product not accessible to provide required service.

EXCLUSION OF IMPLIED WARRANTIES—Your sole and exclusive remedy is product repair as provided in this Limited Warranty. Any implied warranties, including the implied warranties of merchantability or fitness for a particular purpose, are limited to one year or the shortest period allowed by law.

This warranty is extended to the original purchaser and any succeeding owner for products purchased for home use within the USA. If the product is located in an area where service by a GE Authorized Servicer is not available, you may be responsible for a trip charge or you may be required to bring the product to an Authorized GE Service location. In Alaska, the warranty excludes the cost of shipping or service calls to your home.

Some states do not allow the exclusion or limitation of incidental or consequential damages. This warranty gives you specific legal rights, and you may also have other rights which vary from state to state. To know what your legal rights are, consult your local or state consumer affairs office or your state's Attorney General.

Warrantor: General Electric Company, Louisville, KY 40225

Consumer Support.



GE Appliances Website

ge.com

Have a question or need assistance with your appliance? Try the GE Appliances Website 24 hours a day, any day of the year! For greater convenience and faster service, you can now download Owner's Manuals, order parts, catalogs, or even schedule service on-line. You can also "Ask Our Team of Experts™" your questions, and so much more...



Schedule Service

ge.com

Expert GE repair service is only one step away from your door. Get on-line and schedule your service at your convenience 24 hours any day of the year! Or call 800.GE.CARES (800.432.2737) during normal business hours.



Real Life Design Studio

ge.com

GE supports the Universal Design concept—products, services and environments that can be used by people of all ages, sizes and capabilities. We recognize the need to design for a wide range of physical and mental abilities and impairments. For details of GE's Universal Design applications, including kitchen design ideas for people with disabilities, check out our Website today. For the hearing impaired, please call 800.TDD.GEAC (800.833.4322).



Extended Warranties

ge.com

Purchase a GE extended warranty and learn about special discounts that are available while your warranty is still in effect. You can purchase it on-line anytime, or call 800.626.2224 during normal business hours. GE Consumer Home Services will still be there after your warranty expires.

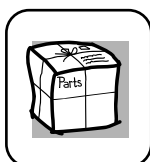

Parts and Accessories

ge.com

Individuals qualified to service their own appliances can have parts or accessories sent directly to their homes (VISA, MasterCard and Discover cards are accepted). Order on-line today, 24 hours every day or by phone at 800.626.2002 during normal business hours.

Instructions contained in this manual cover procedures to be performed by any user. Other servicing generally should be referred to qualified service personnel. Caution must be exercised, since improper servicing may cause unsafe operation.



Contact Us

ge.com

If you are not satisfied with the service you receive from GE, contact us on our Website with all the details including your phone number, or write to: General Manager, Customer Relations
GE Appliances, Appliance Park
Louisville, KY 40225



Register Your Appliance

ge.com

Register your new appliance on-line—at your convenience! Timely product registration will allow for enhanced communication and prompt service under the terms of your warranty, should the need arise. You may also mail in the pre-printed registration card included in the packing material.