

This Owner's Manual is provided and hosted by Appliance Factory Parts.

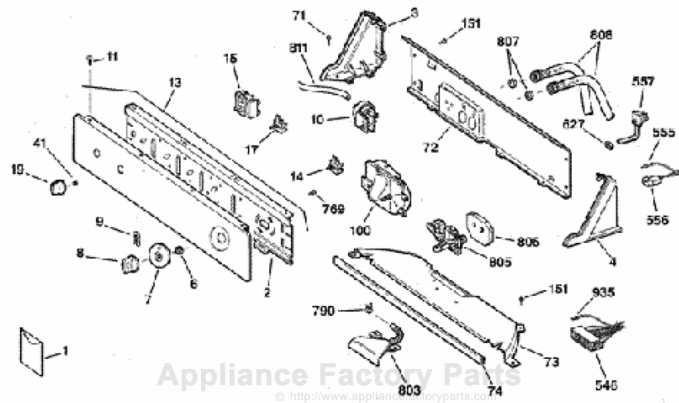

GE YISR309JT8AA Owner's Manual

[Shop genuine replacement parts for GE YISR309JT8AA](#)





[Find Your GE Washer Parts - Select From 4591 Models](#)

----- Manual continues below -----

Washer

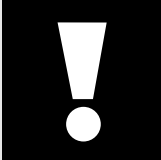
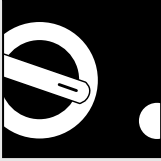
Owner's Manual

	<i>Important Safety Information</i>	2
	<i>Operating Instructions</i> <i>The Controls on Your Washer</i> <i>Other Washer Features</i> <i>Preparing to Wash</i> <i>Care of Product</i>	4
	<i>Helpful Information</i> <i>Specialized Fabric Guide</i>	10
	<i>If Something Goes Wrong</i>	11

RCA

175D1807P286

79-90019

7-99 JR

Printed in the United States



Important Safety Information

Read all safety information before using



Water Heater Safety

Under certain conditions hydrogen gas may be produced in a water heater that has not been used for two weeks or more. **HYDROGEN GAS CAN BE EXPLOSIVE UNDER THESE CIRCUMSTANCES.**

If the hot water has not been used for two weeks or more, prevent the possibility of damage or injury by turning on all hot water taps and allow them to run for several minutes before using any electrical appliance which is connected to the hot water system. This will allow any hydrogen gas to escape. Since the gas is flammable, do not smoke or use an open flame or appliance during this process.

SAVE THESE INSTRUCTIONS



Warning

To reduce the risk of fire, electric shock, or injury to persons when using your appliance, follow basic precautions, including the following sections.

Safety Precautions

- Use this appliance only for its intended purpose as described in this Owner's Manual.
 - Properly ground to conform with all governing codes and ordinances. Follow details in Installation Instructions.
 - Install or store where it will not be exposed to temperatures below freezing or exposed to the weather.
- Do not repair or replace any part of the appliance or attempt any servicing unless specifically recommended in this Owner's Manual or in published user-repair instructions that you understand and have the skills to carry out.
- Do not tamper with the controls.
- Never reach into the washer while it is moving.
- Close supervision is necessary if this appliance is used by or near children or infirm persons. Do not allow children to play inside, on or with this appliance or any discarded appliance. Dispose of discarded appliances and shipping/packing materials properly. Before discarding a washer, or removing from service, remove the washer lid.
- Do not wash or dry articles that have been cleaned in, washed in, soaked in, or spotted with combustible or explosive substances (such as wax, oil, paint, gasoline, degreasers, dry-cleaning solvents, kerosene, etc.) which may ignite or explode. Do not add these substances to the wash water. Do not use these substances around your washer and/or dryer during operation.
- To minimize the possibility of electric shock, unplug this appliance from the power supply or disconnect the washer at the household distribution panel by removing the fuse or switching off the circuit breaker before attempting any maintenance or cleaning.
- **NOTE:** Turning the Cycle Selector knob to an off position does NOT disconnect the appliance from the power supply.

Operating Instructions



The controls on your washer

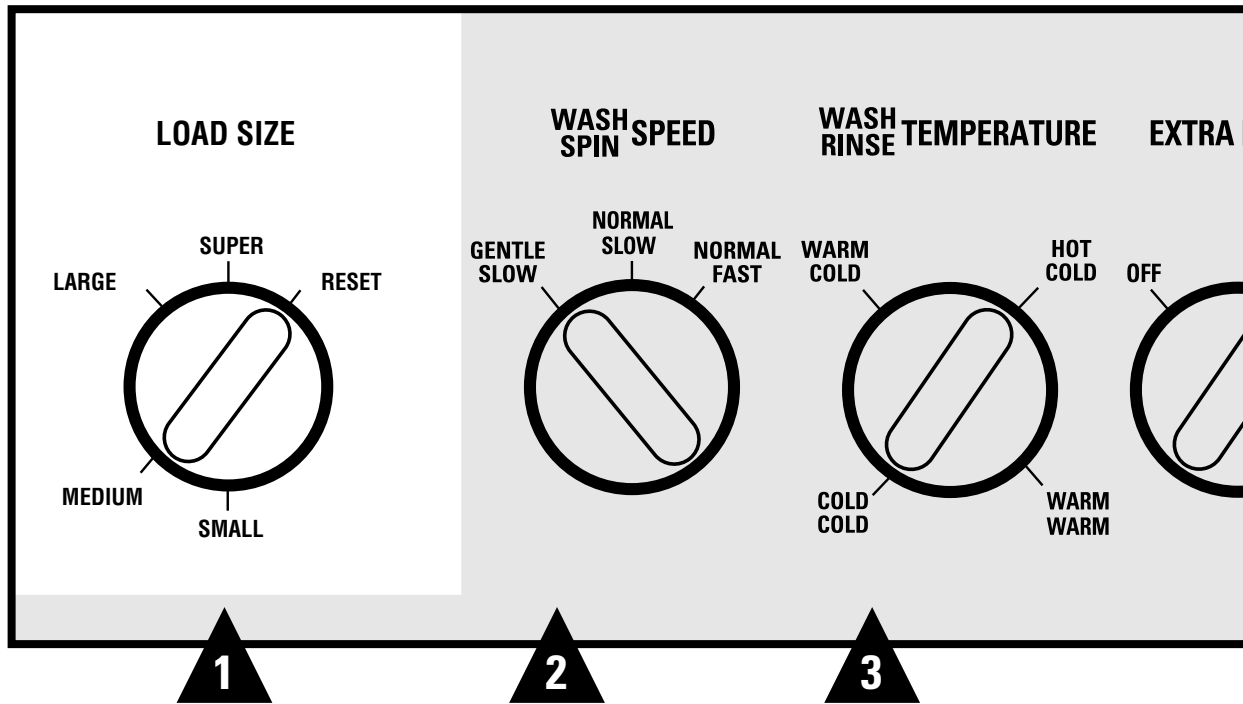

1 Load Size

By selecting load size, you are setting the water level. For the best results, select a size appropriate for the load you are washing.

2 Wash/Spin Speed

This refers to the speed of the agitator during the wash and the basket during the spin.

With the Normal wash speed the agitator moves faster. Use for cottons, denims and play clothes. With the Gentle wash speed the agitator moves slower. Use for delicate and knit items.

The Fast spin speed is for durable items. The Slow spin speed is for delicate items like sweaters and lingerie. Clothes will be less dry than when using a fast spin speed.

Cycle Descriptions



COTTONS REGULAR

For heavily to lightly soiled cottons, linens, work and play clothes.

PERMANENT PRESS

For synthetics and blends with normal soil.

KNITS

Specially designed for normally soiled knits.

DELICATES

For lingerie and specialcare fabrics with light to normal soil.

AUTO SOAK

For heavily soiled clothes. Begins with a brief agitation, soaks for a specified period of time, then moves through the rest of the cycle automatically.

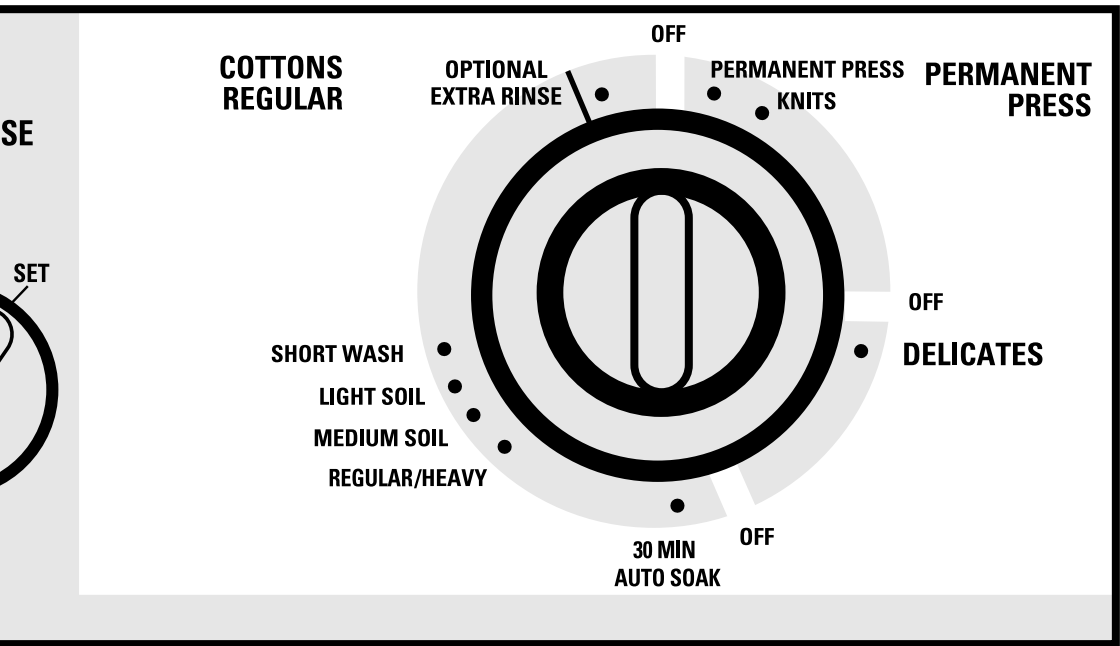

4

3 Wash/Rinse Temp

Always follow Fabric Manufacturer's Care Label or instructions when laundering. Use this chart as a general guide.

	wash temperature	rinse temperature
COTTONS WHITE	hot	cold
COTTONS COLORS	warm*	cold
PERMANENT PRESS	warm*	cold
DELICATES	cold	cold
WASHABLE WOOLENS	warm*	warm*

*Warm water is approximately 32°C. to 43°C. (90°F. to 110°F.) (hand comfortable).

For information on fabric care for specialty items see the Specialty Care Guide.

4 Selecting Cycle/Starting Washer

- Push in the Cycle knob to select the desired cycle. See the above Cycle Descriptions.
- Add detergent.
- Add clothes and close lid.
- Pull out the Cycle knob to start washer.

See next page for other washer features



Operating Instructions

Other washer features your model may have

Extra Rinse

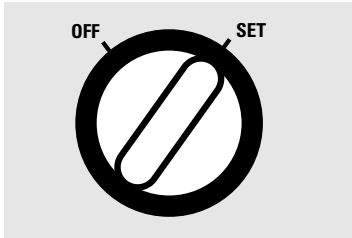

When you use extra detergent or bleach to clean heavily soiled clothes, you may want to use the Extra Rinse option. This option provides a second deep cold rinse in the Cottons Regular cycle. Turn the Extra Rinse knob to SET.

The washer will pause for a few minutes before the Extra Rinse option begins.

Liquid Bleach Dispenser

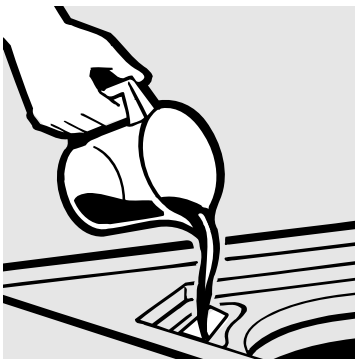

Pour liquid bleach into bleach dispenser

This dispenser dilutes liquid chlorine bleach before it reaches into your wash load. To use, follow these steps:

- 1 Check clothing care labels for special instructions.
- 2 Measure liquid bleach carefully, following instructions on bottle.
- 3 Before starting the washer, pour measured amount of bleach directly into bleach dispenser. Avoid splashing or over-filling dispenser.

NOTE:

- **Never pour undiluted liquid chlorine bleach directly onto clothes or into the wash basket.**
- **Do not pour powdered bleach into bleach dispenser. If you prefer to use powdered bleach, pour it into the wash basket with your detergent.**

Agitator Cap

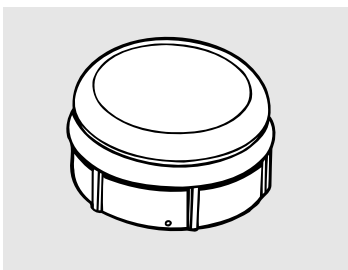

This cap fits into the top of the agitator. If it accidentally comes off, simply put it back on.



Do not pour anything into the agitator if the top is removed



Fabric Softener Dispenser



Pour liquid fabric softener and water into fabric softener dispenser

This dispenser automatically releases liquid fabric softener at the proper time during the cycle. To use, follow these steps:

- 1 Make sure dispenser is securely attached to agitator.
- 2 Pour liquid fabric softener into dispenser, using amount recommended on package.
- 3 Add water to dispenser until it reaches the maximum fill line.

NOTE:

- **Do not stop the washer during the first spin. This will cause the dispenser to empty too soon.**
- **Do not use the Fabric Softener Dispenser with the Auto Soak.**
- **Never pour fabric softener directly on clothes. It will leave spots on clothes.**
- **Only use dispenser for liquid fabric softeners. If dispenser gets clogged, see Cleaning section below.**



Do not pour anything into the agitator if the top is removed

Cleaning Fabric Softener Dispenser

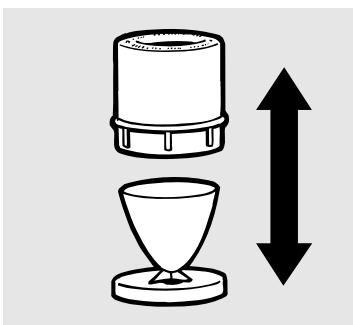

Separate for cleaning

- 1 Remove the dispenser from the top of the agitator.
- 2 Separate the dispenser cup from the cover by grasping the top and pushing down on the inside of the cup with your fingers. Dispenser cup will pop free from the cover.
- 3 To clean dispenser, soak both the dispenser cup and the dispenser cover in a solution of warm water and liquid detergent.
- 4 If necessary, loosen build-up with a clean, soft cloth after soaking. Do not use a stiff brush; you may roughen the surface of the dispenser.
- 5 Rinse and reassemble dispenser. Place dispenser back on the agitator.

Lint Filter

The lint filter is located under the agitator. It is self-cleaning and requires no maintenance.



Operating Instructions

Preparing to Wash

Sort

Always follow Fabric Manufacturer's Care Label when laundering.

Sort by color

(Separate colorfast from non-colorfast fabrics*)

- Whites
- Lights
- Darks

Separate by fabric type

- Cottons and linens
- Permanent press cottons and blends
- Synthetic and poly knits
- Delicates

Separate lint producers from lint collectors

- Lint producers: terry cloth and chenille
- Lint collectors: velveteen and corduroy

Sort by soil

- Light
- Medium
- Heavy

** Non-colorfast fabrics may bleed or fade. Sort by individual color.*

Detergent

Always add detergent before adding clothes so that the detergent can work effectively.

Using the correct amount of detergent is one of the most important things you can do to make sure your wash comes out clean. Always follow the detergent package directions.

Using too little detergent is a common cause of laundry problems. Use more detergent if you have hard water, large loads, greasy or oily soils or lower water temperature.



Load

Load dry items loosely, spacing evenly around agitator, and close the lid.

A typical wash load: two twin sheets, two tablecloths, four collared shirts, three pillow cases, three small bath towels, three t-shirts, and three pairs of shorts.

Place large items in bottom, small items in the middle and medium items on top.

When loading wet items make sure you set the load/water level high enough to allow the items to move freely.

Wash bulky items like blankets separately.

To add items after washer has started, push in Cycle knob and submerge additional items next to the agitator. Close the lid and pull Cycle knob out to restart.

To reduce wrinkling, give permanent press items, synthetics and poly knits room to move freely in the washer.

NOTE:

- **Do not wrap large items like sheets around the agitator.**
- **Do not wash fabrics containing flammable materials (waxes, cleaning fluids, etc.) in your washer.**

Care & Cleaning

The Washer

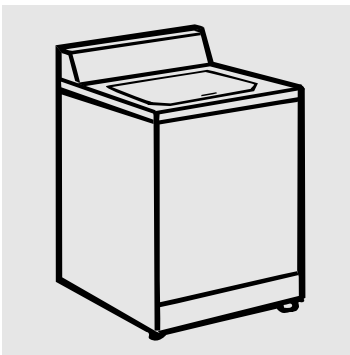

Leave the lid open after washing to allow moisture to evaporate. The wash basket is practically care free.

If you want to clean the washer use a clean soft cloth dampened with liquid detergent, then rinse. (Do not use harsh or gritty cleaners.)

Fill Hoses—Hoses connecting washer to faucet should be replaced every five years.

Moving and Storage—Ask the service technician to remove water from drain pump and hoses. Contact your local distributor for information on how to keep the tub stationary when moving the washer.

Long Vacations—Be sure water supply is shut off at taps. Drain all water from hoses if weather will be below freezing.



Helpful Information

Specialty Care Guide

***Always follow Fabric Manufacturer's Care Label or instructions when laundering.
Otherwise use the information below as a general guide.***

<i>Item</i>	<i>Suggested Care</i>
Down-Filled Garments	Always wash down-filled garments separately from other types of garments. Wet down gives off an odor that will disappear when the down is dried. Wash down items frequently to fluff up the down and to retain down's warmth. When washing make sure the load is balanced. Add towels if necessary. Always tumble-dry down garments.
Pillows	Pillows are made from a variety of materials. Wash only if recommended on the Pillow Manufacturer's Care Label. Before washing check pillows for weak seams or holes, and mend. Let the washer fill with water and add detergent. Let the washer agitate for several minutes and then add pillows in pairs. This will keep the load balanced. Use the largest load/water level available.
Blankets	Let the washer fill with water, add detergent, allow detergent to dissolve, then add blanket. Wash only one blanket at a time.
Permanent Press Clothes that are Line Dried	Select a larger load/water level than normal. This will provide more water to help reduce wrinkling and to allow clothes enough room to move around. Remove clothes as soon as the wash cycle is complete and hang them up immediately.
Heavy Loads	The SUPER WASH cycle is specially designed for extremely heavy loads. For normal load sizes, the REGULAR wash cycle is recommended for optimum performance and water and energy consumption. For best results, always follow the fabric manufacturer's care instructions. If you have any questions, please call the Major Electrical Appliances head office at 02-9825-9424.

If Something Goes Wrong



Problem

Possible Causes

What to Do

Washer Won't Operate

Washer is unplugged

- Make sure cord is plugged securely into a working outlet.

Water supply is turned off

- Turn both hot and cold taps fully on.

Controls are not set properly

- Check controls and make sure Cycle knob is pulled out to ON position.

Lid is open

- Close lid and pull Cycle knob out to ON position.

Circuit breaker/fuse is tripped/blown

- Check house circuit breakers/fuses. Replace fuses or reset breaker. Washer should have separate outlet.

Water Temperature is Incorrect

Control is not set properly

- Check water temperature control and adjust.

Water supply is turned off or improperly connected

- Turn both hot and cold taps fully on and make sure hoses are connected to correct taps.

Water valve screens are stopped up

- Turn off the water source and remove the water connection hoses from the upper back of the washer. Use a brush or toothpick to clean the screens in the machine. Reconnect the hoses and turn the water source back on.

House water heater is not set properly

- Make sure house water heater is delivering water at 48°C.–65°C. (120°F.–150°F.).

Water Won't Drain

Drain hose is kinked or improperly connected

- Straighten drain hose and make sure washer is not sitting on it.
- Top of drain outlet should be less than 1m (3 ft.) above floor.



If Something Goes Wrong

Problem	Possible Causes	What to Do
Water Leaks	Fill hoses or drain hose is improperly connected	<ul style="list-style-type: none">• Make sure hose connections are tight at taps and make sure end of drain hose is correctly inserted in and secured to drain facility.
	Household drain may be clogged	<ul style="list-style-type: none">• Check household plumbing. You may need to call a plumber.
	Constant water pressure to the fill hoses at the water source	<ul style="list-style-type: none">• Tighten hoses at the taps and turn the water off after each use.• Check condition of the fill hoses; they may need replacement after 5 years.
Washer is Noisy	Washer is uneven	<ul style="list-style-type: none">• Make sure washer is level and firm to the floor.
	Washer load is unbalanced	<ul style="list-style-type: none">• Push the Cycle knob in to stop the washer, open the lid and redistribute the load evenly. Close the lid and restart.
	Shipping rod has not been removed	<ul style="list-style-type: none">• Remove the shipping rod on the bottom right side of the washer just before sliding the washer in place. Do not use the washer with the shipping rod in place.
	Water is draining	<ul style="list-style-type: none">• There will be a gurgling “sucking” sound prior to the spin cycle. This is normal and will stop as soon as the machine goes into the spin cycle.
Washer Pauses in Cycle	The washer normally pauses between washing steps	
Clothes too Wet	Incorrect cycle selected	<ul style="list-style-type: none">• Make sure the cycle selected matches the load you are washing.
	This is normal for some fabrics	

**Problem****Possible Causes****What to Do****Lint or Residue on Clothes****Incorrect sorting**

- Separate lint producers from lint collectors.

Washing too long

- Wash small loads for a shorter time than larger loads.

Detergent not dissolving

- For best performance always add detergent before adding clothes. If you use powdered detergent, pre-dissolve detergent in hot water before adding to washer.
- Try a liquid detergent.
- Use warmer water temperature.

Overloading

- Make sure load/water level setting matches load size.

Too much bleach

- Check bleach package for correct amount.

Not enough detergent

- Try using more detergent.

Incorrect use of fabric softener

- Check fabric softener package for instructions (see Fabric Softener Dispenser section).

Wrinkling**Improper loads**

- Avoid mixing heavy items (like work clothes) with light items (like blouses).
- Separate permanent press from other laundry.
- Try a fabric softener.

Overloading or incorrect water level

- Load your washer so clothes have enough room to move freely.

Incorrect wash and dry cycles

- Match Cycle selection to the type of fabric you are washing (especially for permanent press loads).

Repeated washing in water that is too hot

- Wash in warm or cold water with plenty of detergent.



If Something Goes Wrong

<i>Problem</i>	<i>Possible Causes</i>	<i>What to Do</i>
Snags, Holes, Tears, Rips, or Excessive Wear	Pins, snaps, hooks, sharp buttons, belt buckles, zippers, and sharp objects left in pockets	<ul style="list-style-type: none">• Fasten snaps, hooks, buttons, and zippers.• Remove loose items like pins, objects in pockets and sharp buttons.• Turn knits (which snag easily) inside out.
	Undiluted chlorine bleach	<ul style="list-style-type: none">• Check bleach package instructions for proper amount.• Never add undiluted bleach to wash or allow clothes to come in contact with undiluted bleach.
	Small tears or holes present before wash	<ul style="list-style-type: none">• Repair tears and holes before washing.
	Chemicals like hair bleach, hair dye, permanent wave solution and toilet bowl cleaners	<ul style="list-style-type: none">• Rinse items that may have chemicals on them before washing.
	Permanent press items naturally fray (especially collars and cuffs)	<ul style="list-style-type: none">• While this is not caused by the washer, you can slow the fraying process by washing small permanent press loads with a higher load/water level setting.• Avoid washing heavy items (like towels) with permanent press items.
Shrinkage	Some fabrics will naturally shrink in the wash	<ul style="list-style-type: none">• Hot water is more likely to cause shrinkage than cold water.• Follow directions on fabric care label.



Problem

Possible Causes

What to Do

Grayed Clothes

Not enough detergent (larger loads, heavy soil, and hard water might require more detergent)

- Try using more detergent (especially with larger loads).
- If you live in a hard water area try using a water conditioner or install a water softener.

Water is not hot enough

- Make sure water heater is delivering water at 48°C.-65°C. (120°F.-150°F.).
- Do not use the washer when hot water is used for other needs (dishes, baths, etc.).

Washer is overloaded

- Make sure load/water level setting matches load size.

Soak time is too short

- Soak at least 30 minutes.

Soaking with too little detergent

- Use more detergent (especially with heavy soil).

Detergent is not dissolving

- Add detergent as wash basket fills with water before you load clothes.

To restore grayed clothes, try one of the following

- Put clothes through a wash cycle using hot water. (Check the garment's manufacturing care label to see if hot water can be used.) Add a non-precipitating water softener. Use 2 1/2 times more than is recommended for normal water softening. Do not use detergent or soap. Allow clothes to go through a complete cycle. Repeat if necessary.
- Soak your clothes using a water softener instead of a soaking agent. Allow clothes to soak for about 20 minutes.



If Something Goes Wrong

Problem	Possible Causes	What to Do
Yellowed Clothes	Not enough detergent on a consistent basis	<ul style="list-style-type: none">• Always use the recommended amount of detergent.
	Chlorine bleach may yellow some fabrics	<ul style="list-style-type: none">• Use non-chlorine bleach.
	Iron or manganese in water may cause yellowing or yellow spots	<ul style="list-style-type: none">• Use extra detergent plus a non-precipitating water softener dissolved in water and non-chlorine bleach.• Run hot water for 2 minutes to help the pipes clean out iron buildup.• Drain your house water heater occasionally.• To remove spots spread stain area over a pan of boiling water and squeeze lemon juice through the stain.
Blue or Gray Spots	Incorrect use of fabric softener	<ul style="list-style-type: none">• Check fabric softener package for instructions (see Fabric Softener Dispenser section).
		<ul style="list-style-type: none">• To remove spots dampen the spots and rub with undiluted liquid detergent. Rewash, using chlorine bleach if it is safe for the fabric.
Too Many Suds	Type of detergent	<ul style="list-style-type: none">• Switch to a lower sudsing detergent brand and follow instructions on package.
	Very soft water	<ul style="list-style-type: none">• Try less detergent.
Pilling	Result of normal wear on poly-cotton blends	<ul style="list-style-type: none">• While this is not caused by the washer, you can slow the pilling process by washing poly-cotton blends inside out.