

This Owner's Manual is provided and hosted by [Appliance Factory Parts](#).

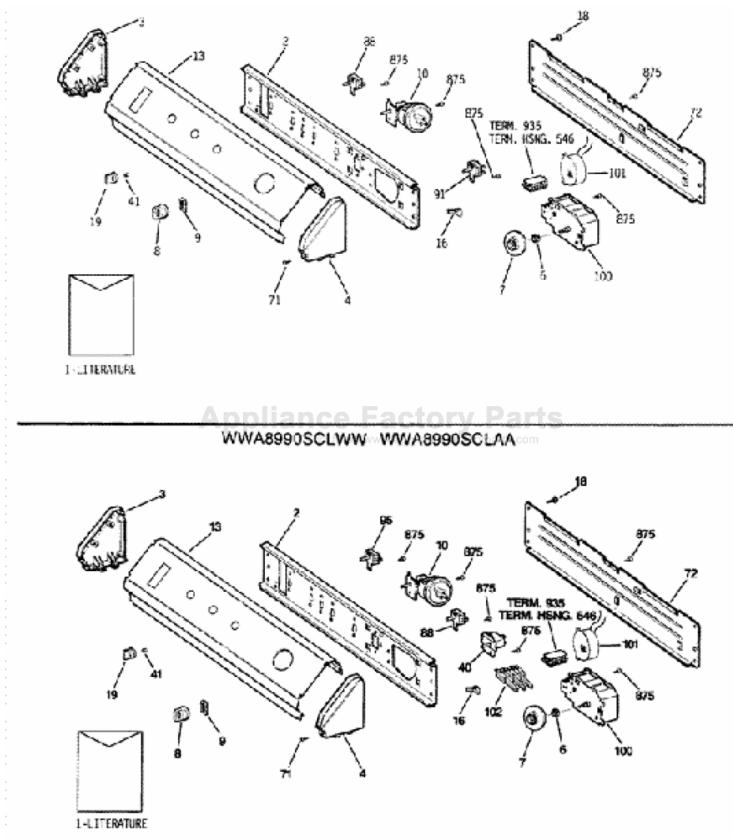

# GE WWA8620SCLAA Owner's Manual

[Shop genuine replacement parts for GE  
WWA8620SCLAA](#)



[Find Your GE Washer Parts - Select From 4591 Models](#)

----- Manual continues below -----



# Use and Care Guide

## Washer



**Safety** instructions .....3, 4



### Operating Instructions, Tips

Auto Soak .....	7
<b>Bleach Dispenser</b> .....	7
Control Settings .....	6
Cycle Descriptions .....	5
<b>Cycle Times</b> .....	6
<b>Energy-Saving Tips</b> .....	7
<b>Operating the Washer</b> .....	6-7
<b>Suggested Fabric and Cycle Settings</b> .....	8



### Care and Cleaning

Agitator .....	19
Storage and Vacation Tips .....	19
<b>User Maintenance Instructions</b> .....	19



**Problem Solver**.....15-19

More questions ?...call  
**GE Answer Center™ 800.626.2000**



### Preparation

<b>Detergents and Additives</b> .....	11, 12
Hard Water .....	11
<b>Loading the Washer</b> .....	6, 10
<b>Sorting Clothes</b> .....	6, 9
Stains .....	13
Stain Removal Guide .....	14



**Consumer Services** .....24

<b>Appliance Registration</b> .....	2
<b>Important Phone Numbers</b> .....	24
<b>Model and Serial Numbers</b> .....	2
Repair Service .....	2
Warranty .....	Back Cover

**Model:** **WWA8620SCL**



# HELP US HELP YOU...

## Read this book carefully.

It is **intended** to help you operate and maintain your new washer properly.

Keep it handy for answers to your questions.

If you don't understand something or need more help, write (include your phone number):

Consumer Affairs  
GE Appliances, Appliance Park  
Louisville, KY 40225

## Save time and money.

Before you request service . . . check the Problem Solver section. It lists causes of minor operating problems that you can correct yourself.

## If you received a damaged washer...

Immediately contact the dealer (or builder) that sold you the washer.

## Write down the model and serial numbers.

You'll find them on a label on the lower left side near the front.

These numbers are also on the Consumer Product Ownership Registration Card that came with your washer. Before sending in this card, please write these numbers here:

Model Number \_\_\_\_\_

Serial Number \_\_\_\_\_

Use these numbers in any correspondence or service calls concerning your washer

To obtain a Spanish language version of this book, call GE Answer Center® 800.626.2000 consumer information service.

Para obtener la versión en español de este manual, name a GE Answer Center®, servicio de información para el consumidor, teléfono 800.626.2000.

**WARNING: For your safety the information in this manual must be followed to minimize the risk of fire or explosion or to prevent property damage, personal injury or loss of life.**

—Do not store or use gasoline or other flammable vapors and liquids in the vicinity of this or any other appliance,

### —WHAT TO DO IF YOU SMELL GAS

- Do not try to light any appliance.
- Do not touch any electrical switch; do not use any phone in your building.
- Clear the room, building or area of all occupants.

• Immediately call your gas supplier from a neighbor's phone. Follow the gas supplier's instructions.

• If you cannot reach your gas supplier, call the fire department.

—Instigation and service must be performed by a qualified installer, service agency or the gas supplier.

All washing instruction terms in this book conform to the Care Labeling Rule established by the Federal Trade Commission, January 1984.

## If You Need Service

To obtain service, see the Consumer Services page in the back of this book.

We're proud of our service and want you to be pleased. If for some reason you are not happy with the service you receive, here are three steps to follow for further help.

**FIRST**, contact the people who serviced your appliance. Explain why you are not pleased. In most cases, this will solve the problem.

**NEXT**, if you are still not pleased, write all the details—including your phone number—to:

Manager, Consumer Relations  
GE Appliances, Appliance Park  
Louisville, KY 40225

**FINALLY**, if your problem is still not resolved, write:

Major Appliance Consumer Action Panel  
20 North Wacker Drive  
Chicago, IL 60606

# IMPORTANT SAFETY INSTRUCTIONS

Read all instructions before using your appliance.



**A** WARNING-TO reduce the risk of fire, electric shock, or injury to persons when using your appliance, follow basic precautions, including the following:

- Use this appliance only for its intended purpose as described in this Use and Care Book.



- This washer must be properly installed and located in accordance with the Installation Instruction

before it is used. If you did not receive an Installation Instructions sheet with your washer, you can obtain one by calling, toll free, the GE Answer Center<sup>®</sup>, 800,626.2000.

- Properly ground to conform with all governing codes and ordinances. Follow details in Installation Instructions.
- Install or store where it will not be exposed to temperatures below freezing or exposed to the weather.
- Connect to a properly rated, protected and sized power supply circuit to avoid electrical overload.
- Connect to adequate plumbing and drain facilities as described in the Installation Instructions.

- Turn off water faucets when the washer is not in use to relieve pressure on hoses and valves, and to minimize leakage if a hose or valve should break or rupture.



- When disconnecting this appliance pull by the plug rather than the cord to avoid damage to the cord or junction of cord and plug. Make sure that the cord is located so that it will not be stepped on, tripped over or otherwise subjected to damage or stress,



- Do not repair or replace any part of the appliance or attempt any servicing unless specifically recommended in this Use and Care Book or in published user-repair instructions that you understand and have the skills to carry out.

## To minimize the possibility of injury:



- Do not mix chlorine bleach with ammonia or acids such as vinegar and/or rust remover. Mixing can produce a toxic gas which may cause death.



- Do not wash or dry articles that have been cleaned in, washed in, soaked in, or spotted with soap, combustible or explosive substances (such as wax, paint, gasoline, degreasers, dry-cleaning solvents, kerosene, etc.) which may ignite or explode. Do not add these substances to the wash water. Do not use these substances around your washer and/or dryer during operation,



**WARNING—HYDROGEN GAS** is produced by the chemical action within your water heater and the gas can accumulate in the water heater and/or water pipes if hot water has not been used for a period of two weeks or longer. **HYDROGEN GAS CAN BE EXPLOSIVE UNDER THESE CIRCUMSTANCES.** So to prevent the possibility of damage or injury, if you have not used hot water for two weeks or more, or move into a residence in which the hot water system may not have been used for some time, turn on all hot water faucets and allow them to run for several minutes before using any electrical appliance which is connected to the hot water system. This will allow any hydrogen gas to escape. Since the gas is flammable, do not smoke or use an open flame or appliance during this process.

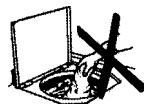

- Never reach into washer while it is moving. Before loading, unloading or adding clothes, push in the Cycle Selector knob to OFF position, then wait until the machine has completely stopped before opening the lid.



- Close supervision is necessary if this appliance is used by or near children. Do not allow children to play inside, on, or with this appliance or any discarded appliance. Dispose of discarded appliances and shipping or packing materials properly. Before discarding a washer, or removing from service, remove the washer lid.

(continued next page)



# IMPORTANT SAFETY INSTRUCTIONS

(continued)



- Keep all laundry aids (such as detergents, bleaches, fabric softeners, etc.) out of the reach of children, preferably in a locked cabinet. Observe all warnings on container labels to avoid personal injury.



- Keep the area around and underneath your appliances free from the accumulation of combustible materials, such as lint, paper, rags, chemicals, etc.

- Keep the floor around your appliances clean and dry to reduce the possibility of slipping.



- To minimize the possibility of electric shock, unplug this appliance from the power supply before attempting any maintenance or cleaning (except the removal and cleaning of the lint filter).

**NOTE:** Turning the Cycle Selector knob to an OFF position does NOT disconnect the appliance from the power supply.

\*

- Do not tamper with controls.

- Do not operate this appliance if it is damaged, malfunctioning, partially disassembled, or has missing or broken parts, including a damaged cord or plug.

- Never climb on or stand on the washer top.

- Do not wash fiberglass articles in your washer. Skin irritation could result from the remaining particles that may be picked up by clothing during subsequent washer use.



- The laundry process can reduce the flame retardancy of fabrics. To avoid such a result, the garment manufacturer's care instructions should be followed very carefully.

---

## For washer operation

- Do not leave washer lid up during cycle. This will stop the wash and spin action and prevent completion of the cycle.

## SAVE THESE INSTRUCTIONS

# TIPS TO HELP YOU SELECT SETTINGS

Cycle names and features may vary



## Regular Cycles—

For most cottons, linens, work and play clothes. Longer wash times plus deep rinse, spray rinse and spin provide thorough washing and detergent removal.

## Permanent Press Cycles—

For loads of synthetics, blends and/or delicate fabrics. A cold water cool down helps prevent set-in wrinkles in permanent press shirts, blouses, dresses and similar apparel with normal soil.

## Handwash System—

Saves time and energy when washing small loads of lightly soiled clothes. A special agitator concealed under the regular agitator washes small and delicate loads gently but effectively. The Handwash System uses up to 2470 less water than the regular low water level selection.

## Spotscrubber System—

The Spotscrubber cycle uses a special wash cycle and a highly concentrated detergent solution in a small amount of water in the Mini-Basket tub.

Rinse water carries away soils and detergent suds and automatic extra rinse assures complete removal of detergent.

## Optional Extra Rinse Cycle—

The option of an extra rinse helps assure complete bleach and detergent removal when extra detergent was used or where unusual skin sensitivity to detergent is a concern.

## PreWash Cycle—

For use when clothes are excessively soiled. Provides an agitated soak, and a soak without agitation, followed by agitation and spin. Washer must be reset for desired wash cycle.

## Knits Cycle—

A shorter cycle specially-designed for today's knits. An early and long spray rinse cools down fabrics before the washer reaches maximum spin speed to help prevent wrinkle setting.

## Extra Cleaning Cycle—

For modern fabrics with heavy or oily soil. Agitation for a longer time loosens stubborn soils.

## Soak Cycle—

Clothes activate in a soaking agent for a short time, then the water spins out. Washer turns off at end of Soak Cycle—must be reset for desired wash cycle.

## Auto Soak Cycle—

This will add additional wash time on cycles to allow the detergent to break down excessive soils. After the Auto Soak is complete, it will automatically move through the selected cycle.

## Delicate Cycle—

For lingerie and fabrics requiring special care, this cycle has a gentle wash and a slow spin.

## Washable Woolens Cycle—

This cycle helps to reduce the need to wash these fabrics by hand.

## Washable Silks Cycle—

For fine washable silks. Check manufacturers' care labels for special instructions.

## Mini-Basket System—

Uses the Mini-Basket feature. Provides a complete wash, rinse and spin cycle.



# HOW TO OPERATE YOUR CLOTHES WASHER

Features and appearances may vary slightly

**WARNING—To reduce the risk of fire, electric shock, or injury to persons when using your appliance, read the IMPORTANT SAFETY INSTRUCTIONS before operating this appliance.**

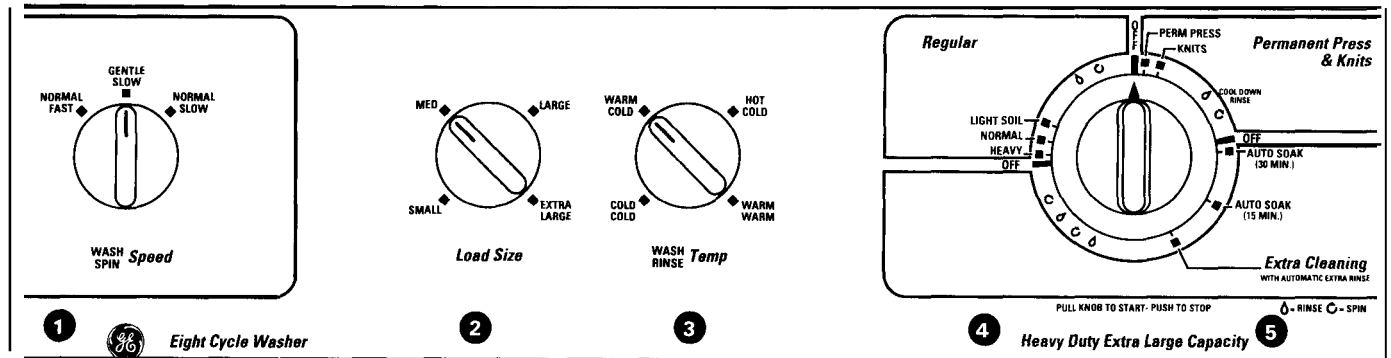

## Setting the Controls

Use the Suggested Fabric and Cycle Settings guide to help you make the proper selections.

### 1 Select Wash Spin Speed.

### 2 Select Water Level.

**SMALL:** Washer is less than 1/3 full of clothes.

**MEDIUM:** Between 1/3 and 1/2 full.

**LARGE:** Between 1/2 and 2/3 full.

**EXTRA LARGE:** Over 2/3 full.

### 3 Select Wash/Rinse Temperature.

### 4 Push Cycle Selector knob in and turn clockwise to your selected wash setting.

### 5 Pull Cycle Selector knob out to start the washer, If you wish to change setting after washer has started, push Cycle Selector knob in to stop the washer and reset to the new position. Setting can be changed at any time.

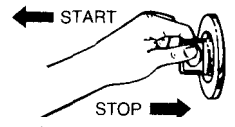

## Sorting and Loading

- Sort clothes carefully by fabric type, weight, color and amount of soil, according to instructions in How to Sort clothes section.
- Add measured amount of detergent. See Detergents section for information on detergents and other laundry additives.
- Load clothes into wash basket, being careful not to overload. See How to Load Your Washer section.
- See Bleach Dispenser section for instructions in its use.
- For information on how to use bleaches and fabric softeners, see Other Laundry Products section.
- Close the lid. Washer will fill but not agitate or spin with the lid open.

## Cycle Times — Total Cycle Times (Approximate Minutes)

### NOTES:

- Total time includes pauses between each phase of the cycle.
- Total time does *not* include water fill times. Fill times vary depending on household water pressure and your selected water level.

Perm Press & Knits	Extra Cleaning*	Regular
24	33	26

\* Total Cycle Minutes do not include the auto soak cycle You have chosen.

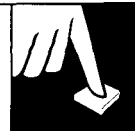

## How to Use the Bleach Dispenser

Use this dispenser with liquid bleach only. If you prefer to use powdered bleach, pour it into the wash basket along with your detergent. Do not pour powdered bleach into the bleach dispenser.

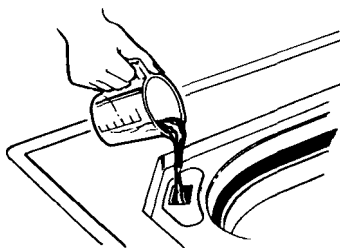

- Measure bleach carefully. See manufacturer's instructions.
- Pour measured amount of liquid bleach directly into bleach dispenser.
- **Do not overfill or allow dispenser to overflow.** Avoid splashing. Undiluted bleach can cause fabric damage.
- **Never pour undiluted liquid bleach directly onto clothes or into the wash basket.**

## How to Use the Auto Soak Cycle

In the Auto Soak cycle the washer fills, agitates and soaks for the time you selected. It automatically advances into the next cycle.

- Extra Cleaning with Auto Soak: Set the Cycle Selector knob for soak time desired in Extra Cleaning cycle. Start the washer. The washer will agitate, soak and automatically advance into Extra Cleaning.

## ENERGY-SAVING TIPS

If your clothes and household items don't look clean and fresh after washing, you will probably rewash them.. and that means you'll waste energy. Remember to sort your clothes carefully and load them properly, select correct cycles, use enough detergent and *choose a water temperature warm enough to release and get rid of soil.*

- Try to wash less often. Save articles of the same type of fabric until you have a full load.
- If you must wash smaller loads, adjust the amount of water. Small loads should have lower water levels.

- Always rinse in cold water. The temperature of the rinse does not affect cleaning.
- Wash in off-peak utility hours. Your local utility can tell you which are the off-peak hours.
- Use your washer's Normal Spin. This will remove more water during spin, which will shorten drying cycle to save more energy.



## SUGGESTED FABRIC AND CYCLE SETTINGS

Cycle Suggested	For Clothes Load/Fabrics such as:	Wash/Spin Speed
Permanent Press & Knits	<ul style="list-style-type: none"> <li>•Synthetics</li> <li>•Permanent press, treated cottons, blends with cottons</li> <li>•Down-filled garments, if machine washing is recommended*</li> <li>•Pillows**</li> </ul>	Normal/Slow  Gentle/Slow
Regular	<ul style="list-style-type: none"> <li>•Cottons and linens</li> <li>•Denims</li> <li>•Blankets***</li> <li>•Baby clothes (sturdy)</li> </ul>	Normal/Fast
Extra Cleaning & Auto Soak	<ul style="list-style-type: none"> <li>•Work clothes with heavy soil</li> </ul>	Normal/Fast

Special Instructions	
*Down-filled garments	Wash frequently to fluff up the down and retain the garment's warmth. WASH SEPARATELY. Wet down gives off an odor which maybe absorbed by other garments. Odor disappears when garment is dry. Treat heavily soiled areas with liquid detergent or a paste made of water and powdered detergent. Close zippers. Wash 2 or 3 garments at a time or add towels to balance. GARMENT MUST BE TUMBLE DRIED.
**Pillows	Pillows are made of different materials—dacron, foam, polyester, natural feather, and down. MANUFACTURER'S CARE LABELS MUST BE FOLLOWED CAREFULLY. If washing is recommended, check pillows for weak seams or holes and mend, to prevent escape of the filling. Fill washer, add detergent and agitate for several minutes. Add two pillows at a time to balance load. Use largest water level.
***Blankets	Fill washer with water; add detergent and allow to dissolve. Add blanket. WASH ONLY ONE BLANKET AT A TIME. On electric blanket, sew a strong piece of cloth over plug to protect blanket and washer from damage. Pretreat heavily soiled spots with liquid detergent.

# HOW TO SORT CLOTHES



## Sort by Surface Texture

Separate

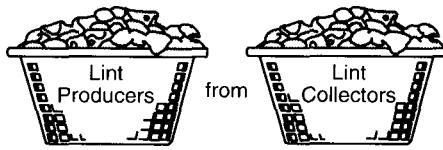

**LINT PRODUCERS**—such as terry toweling and chenille—give up lint.

**LINT COLLECTORS**—such as man-made fibers and napped fabrics like velveteen and corduroy—attract lint. These must be washed separately.

**For more information on lint control, see The Problem Solver section.**

## Sort by Fabric

Separate

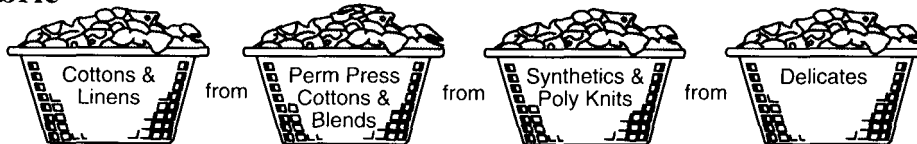

In addition to sorting to reduce lint collection, it is recommended that fabrics of similar construction be washed together whenever possible.

## Sort by Soil

Separate

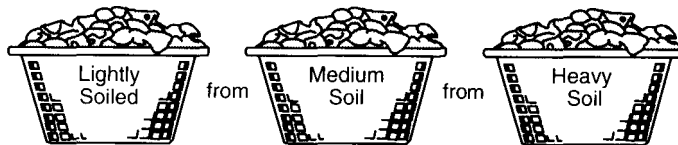

## Sort by Color

Separate

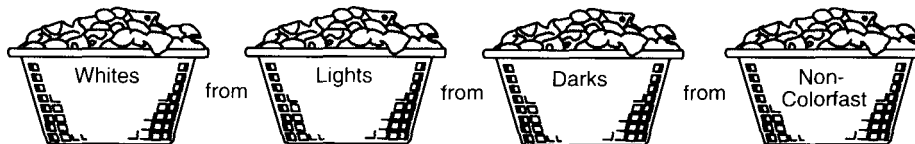

**For instructions on different fabrics and loads, see the Fabric and Cycle Settings guide.**

### It pays to check and prepare clothes for washing.

- Empty pockets, brush out cuffs, zip zippers, and fasten snaps, hooks and buttons.
- Do any necessary mending—rips, hems, tears.
- Check all items for areas of heavy soil or stain.
- Remove stains. See Stain Removal Guide.
- Turn poly knits inside-out to minimize fabric surface damage.

### EXTRA CLEANING

(See Tips to Help You Select Settings section for instructions.)

See Stain Removal Guide.

See Fabric and Cycle Settings guide.

See The Problem Solver section.

### Soaking and Pretreating—a good way to loosen deep soils and stains.

A thorough soaking with detergent or special soaking agent is another way to remove heavy soils, embedded dirt and even some stains.

Soaking can be either a completely separate washing step or a preliminary step to a complete wash cycle. For detailed information on how to soak in your washer, see How to Use the Auto Soak Cycle.

### FOR INFORMATION ON SOAKING AGENTS, see Other Laundry Products Guide.

- Pretreat heavy soil by rubbing in a small amount of liquid detergent or a paste made of water and powdered detergent or soap. For best results, wait 1/2 hour before washing.



## HOW TO LOAD YOUR WASHER

This illustration, with clothes just reaching the Clothes Retaining Ring, shows a proper load. Clothes have ample room to move because they are not packed down, nor wrapped around the agitator. Clothes are loaded dry since wet items are likely to pack down which encourages overloading. This size load requires a full water fill.

**What is the best size load of clothes—large, medium, or small? Save time, energy and detergent** by avoiding extra use of the washer. Try to wash a full load of clothes. If you can it is better to save clothes until you have a full load. If you must wash smaller loads, save water, energy and detergent by adjusting the water level for the size of the load. See Operating Instructions.

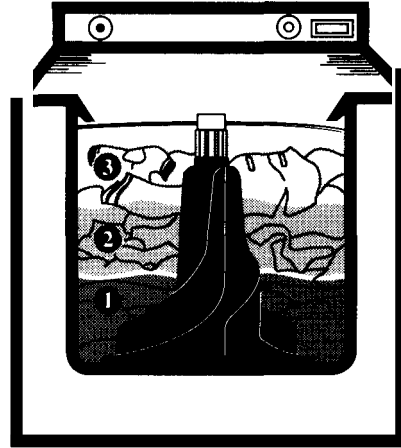

- Load clothes dry.
- Take a properly sorted group of clothes and drop them loosely in the wash basket in this order:

- 1 Large items—like sheets. Do not wrap around the agitator.
- 2 Small items—like washcloths.
- 3 Medium size items—like towels.

### DO NOT OVERLOAD YOUR WASHER.

- Try to mix large and small items in each machine load for better washing action.
- Wash large items (blankets, bed spreads, mattress pads, etc. ) separately.
- If machine is overloaded, you may experience oversudsing or out of balance conditions.

---

### To Add Items After the Washer Has Started

- Turn off the washer by pushing in the Cycle Selector knob.
- Add any additional articles by submerging them next to the agitator.

**NOTE:** When washing stockings, panty hose and other easily tangled items, always handle separately. To minimize tangling, we recommend the use of a net laundry bag.

---

### Special Recommendations for Washing Permanent Press If You Do Not Have a Dryer

If you are machine-washing permanent press clothes that you plan to line dry or drip-dry, use extra care to minimize wrinkling in the wash process:

- Remove clothes promptly as soon as washer stops and hang immediately.
- If you can select a water level, use more water than you would for a regular load. Use a medium water level for a small load. Use an extra large water level for a medium load.

- Be careful not to overload washer. Permanent press clothes must have ample room to move freely. A medium size permanent press load is the largest that should be washed.

# HOW MUCH DETERGENT SHOULD YOU USE?



The use of a sufficient amount of detergent is one of the most important things you can do to make sure your wash comes out clean. Always follow the detergent manufacturer's recommended amount.

## Amount required varies according to:

1. Water hardness
2. Amount of soil
3. Size of load
4. Type of detergent
5. Wash temperature

## Use more detergent if you have...

1. Hard water
2. Large loads
3. Greasy or oily soils
4. Lower wash temperature
5. Low phosphate detergent

If the recommended amount of detergent produces too many suds, switch to a lower sudsing detergent brand, and follow instructions on package.

Using too little detergent is a common cause of laundry problems. Always measure detergent in a standard measuring cup.

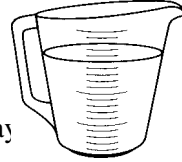

## How to use detergent—granular, powdered or liquid:

For best results, add detergent to the wash basket before loading clothes. If you load your clothes first, add detergent next to the agitator.

## HARD WATER—DO YOU HAVE IT?

Before you can decide what to do about hard water, you need to know if you have it and, if so, how hard it is.

- If you live in a municipal area, contact your water company.
- If you live in a rural area, or in some suburban areas, contact your county agent.

The answer will be “you have ‘so many grains’ per gallon (3.8 liters).” This means:

0 to 3.5 grains per gallon (3.8 liters)—SOFT

3.6 to 7 grains—HARD

7.1 to 10.5 grains—VERY HARD

10.6 grains and over—EXTREMELY HARD

If your water is SOFT, you have no problem. You can use soap or detergent as you prefer and forget all about hard water. If you have HARD water—less than 10 grains—and you use phosphate detergent, you also have no problem.

But, if you have more than 10 grains, you will need to soften your water with either...

1. An installed water softener in your home, or
2. The use of a packaged water softener.

**For information on water softeners, see the manufacturer's recommendations.**



# OTHER LAUNDRY PRODUCTS

Laundry Product and Type	How to Use It	Special Instructions
<p><b>BLEACH</b> Chlorine liquid such as Clorox brand</p> <p>Non-chlorine such as Clorox2 brand</p>	<p>Use your bleach dispenser. See How to Use Your Bleach Dispenser section.</p> <p>If you do not have a bleach dispenser, pour diluted bleach next to the agitator.</p> <p>Follow package directions. Put bleach into washer with detergent.</p>	<p><b>1) Dilute bleach before</b> using on any fabric. Do not pour undiluted liquid chlorine bleach directly into washer or on dry clothes.</p> <p>2) Some of today's washable fabrics should not be chlorine bleached such as: silk, wool, spandex, or non-fast colors.</p> <p>3) Check manufacturers' care labels for special instructions.</p> <p><b>1) May be used on most fabrics. Test fabric first,</b></p>
<p><b>FABRIC SOFTENERS</b> Rinse additive such as Downy brand</p>	<p>Follow package directions for diluting softeners.</p>	<p>1) Helps make clothes fluffy and soft. 2) Reduces static electricity. 3) Use the following manufacturer's direction. Too much may cause a hard, rough feeling on some clothes. 4) Do not pour directly on clothes.</p>
<p><b>SANITIZER</b> Chlorine bleach such as Clorox brand</p>	<p>Use in case of infection and contagious disease. See under Bleach above.</p>	<p>Guards against infection by killing most bacteria and viruses</p>
<p><b>WATER SOFTENER</b> Non-precipitating such as Calgon brand</p> <p>Precipitating such as Borax brand</p>	<p>Follow package directions. Add at start of wash cycle.</p> <p>Follow package directions. Add at start of wash cycle.</p>	<p>Suspends hardness minerals in solution, keeping water clear.</p> <p>Combines with water hardness minerals to form precipitate which gives cloudy or milky appearance to water.</p>
<p><b>SOAK AGENT</b> Such as Biz brand</p>	<p>Follow package directions.</p>	<p>For best results, soak garments a minimum of 30 minutes.</p>
<p><b>PRETREATING, STAIN AND SPOT REMOVERS</b> Such as Spray 'n Wash and K2R brands</p>	<p>Follow package directions. Treat only heavily soiled areas. Check garments' care labels for instructions.</p>	<p><b>CAUTION:</b> Washer and dryer control panels and finishes may be damaged by some laundry pretreatment soil and stain remover products if such products are sprayed on or have direct contact with the washer. Apply these pretreatment products away from washer. The fabric may then be washed normally, Damage to your washer caused by pretreatment products is not covered by your warranty.</p>
<p><b>TINTS AND DYES</b> Powdered such as Rit and Tintex brands</p>	<p>Follow package directions. <b>NOTE:</b> Tinted garments may not be colorfast. Wash separately.</p>	<p>Clean washer to avoid discoloration of next load. Go through complete cycle using hot water, 1/2 cup (120 ml) detergent, 1 cup (240 ml) bleach. Wipe exterior parts. <b>CAUTION:</b> Tinting may discolor plastic in washer. Subsequent washings will reduce discoloration but may never eliminate it.</p>

# HOW TO REMOVE STAINS



1. Try to remove stains as soon as possible.  
The fresher the stain, the easier it is to remove.
2. Before attempting to remove any stain, take these steps:
  - Find the fabric in the chart on the next page, and use only recommended methods.
  - Check the care label instructions that came with the garment.
  - Test stain removal product on a hidden inside seam or on a sample of the material.
  - Avoid use of hot water on unknown stains. It can set some stains.
3. Follow stain removal with a thorough rinsing.
4. Wash with recommended amount of soap or detergent.

## Stain Removal Hint—Using Chlorine Bleach for White and Bleachable Fabrics

Mix 1/4 cup (60 ml) chlorine bleach with one gallon (3.8 liters) of cool water—approximately 80°F.(27°C.)—in a sink or pan. Soak stained area for 5 minutes and launder in washer.

## The Case of the “Invisible” Stain

Food or cooking oils on your synthetic garments may cause stains which are virtually invisible and which you may not notice as you put your clothes into the washer.

If these stains are not completely removed in the wash, the oily spots may pick up dirt from the wash water. Then they will become very visible and you may think they were caused by the wash cycle itself.

## Once These Spots Become Visible, How Can You Remove Them?

- Rub in undiluted liquid detergent and let stand 30 minutes.
- Rewash using hottest water the fabric can stand.

## How Can You Prevent These “After-You-Wash” Stains?

- Increase the amount of detergent normally used.
- Increase water temperature where fabric will permit.
- Wash synthetic garments more often.



# STAIN REMOVAL GUIDE

Stain	White and Bleachable Fabrics See Suggested Fabric and Cycle Settings	Other Washable Fabrics
Adhesives (Chewing Gum, etc.)	Rub with ice or immerse in very cold water. <i>Use dull tool to carefully scrape off as much adhesive or gum as possible.</i> Sponge with a safe dry cleaning fluid, *rinse well, then wash as usual.	Same as white and bleachable fabrics,
Antiperspirants, Deodorants	Apply undiluted liquid detergent. Rinse. If stain remains, bleach according to the Stain Removal Hint; launder. If color has changed, you may be able to restore it by sponging with ammonia.** Rinse thoroughly.	Same as white and bleachable fabrics except use non-chlorine bleach.
Blood	Soak in cold water, then launder in warm water. If stain remains, bleach according to the Stain Removal Hint; launder.	Sponge or soak in cool water, then launder.
Chocolate, Cream, Ice Cream and Milk	Soak in cold water. Treat stain with a safe dry cleaning fluid,* rinse well, then wash as usual. Bleach according to the Stain Removal Hint.	Soak in cold water. Sponge with a safe cleaning fluid, * rinse well, then wash as usual.
Coffee and Tea	Without cream: Bleach according to the Stain Removal Hint; launder. With cream: Follow guide directions for cream.	Sponge with warm water. If stain remains, apply warm glycerine, let stand 30 minutes and rinse well, or sponge with a safe dry cleaning fluid, * rinse well, then wash as usual.
Cosmetics: Eye Shadow, Lipstick, Mascara, Liquid or Pancake Makeup, Rouge, Powder; Crayon; Grease, Oil, Tar, Cod Liver Oil	Treat stain with safe dry cleaning fluid, * rinse well, then wash as usual. Bleach according to the Stain Removal Hint.	Sponge with a safe dry cleaning fluid,* rinse well. then wash as usual.
Fresh Fruit, Fruit Juices. Wine, Vegetables or Food Coloring	Soak stain in cool water. If stain remains, bleach according to the Stain Removal Hint; launder.	Sponge with warm water. Bleach remaining stain with non-chlorine bleach.
Grass, Foliage. Flowers, Mildew, Scorch	Apply undiluted liquid detergent. Launder. (Treat mildew spots while they are fresh. before mold has a chance to weaken fabric.) If either type stain remains, bleach according to the Stain Removal Hint; launder. (Severe scorch cannot be removed.)	Sponge with warm water. Apply <i>undiluted liquid detergent</i> . Bleach remaining stain with non-chlorine bleach, then launder, Old mildew stains can seldom be removed. Scorch can seldom be removed.
Ink, Ballpoint	Fresh stains: Place stain face down on an absorbent towel and use a spray cleaner or sponge with dry cleaning fluid, * rinse well, then wash as usual. Old stains: Bleach according to the Stain Removal Hint; launder.	Same as white and bleachable fabrics except launder using non-chlorine bleach.
Perspiration	Apply undiluted liquid detergent and launder in warm water. If color has changed you may be able to restore it by treating with ammonia or vinegar,**[if any stain remains, treat with safe dry cleaning fluid,* rinse well, then wash as usual.	Launder in warm water. Rinse well. Bleach with non-chlorine bleach.
Rust	Apply rust remover,** using manufacturer's directions. Rinse andlaunder.	Same as white and bleachable fabrics

**A** \***L. AUTION:** Because cleaning fluids tend to be toxic, be sure you are in a well ventilated room when using them. No cleaning fluid should be used unless user is familiar with the limitations and required cautions (usually printed on label). Use extreme caution with flammable compounds.

Under no circumstances should fabrics containing flammable materials (waxes, cleaning fluids, etc.) be washed in washer.

\*\***Do not mix** chlorine bleach with ammonia or acids such as vinegar and/or rust remover. Mixing can produce a toxic gas which may cause death.

Save and refer to garment manufacturer's care labels.

# QUESTIONS? USE THIS PROBLEM SOLVER



PROBLEM	POSSIBLE CAUSE
<p><b>LINT OR RESIDUE ON CLOTHES</b></p>	<ul style="list-style-type: none"> <li>• Incorrect sorting of clothes. Separate lint producers (such as terry towels and chenille) from lint receivers (such as man-made fabrics, velveteen, corduroy).</li> <li>• <b>Washing too long, especially for smaller loads. For normal soil, wash one minute per pound of dry clothes.</b></li> <li>• Use of non-phosphate detergents which combine with hardness minerals to form a precipitate which can be mistaken for lint. Use a phosphate or liquid detergent; use warmer wash water or soften water with an installed mechanical softener or a packaged water softener.</li> <li>• Powdery residue from granular detergent may appear to be lint. Predissolve granular detergent in hot water before adding to washer; make sure detergent is completely dissolved before <b>adding</b> clothes; switch to liquid or cold water detergent or use warmer wash water. See Detergent section.</li> <li>• Overloading will cause abrasion which creates excessive lint. Wash fewer items with correct water level.</li> <li>• Too much bleach. Use correct amount of bleach according to package directions.</li> <li>• Not enough detergent to hold lint in suspension during wash cycle. Increase amount of detergent. See Detergent section.</li> <li>• Incorrect use of fabric softener. If used in wash cycle, softeners may react with detergent to create a white deposit. Use softeners in rinse cycle only unless package specifies adding to wash cycle. See Other Laundry Products section.</li> <li>• Pilling usually on polyester-cotton blends is caused by normal wear and may look like lint. Turning clothes inside-out may provide some help.</li> <li>• Static electricity <b>caused</b> by overdyeing will cause attraction. Use fabric softener in rinse cycle.</li> </ul>
<p><b>GREASY OR OILY STAINS ON LAUNDERED GARMENTS</b></p>	<p>These are sometimes called “Invisible Stains” because you may not notice them before washing clothes. However, if oily soils are not completely removed in wash cycle, the oily spots may pick up dirt from the wash water. The spots will then be very visible. They are <i>not</i> caused by the washer. Wash synthetic garments as soon as possible after wearing. Use more detergent than normal and hottest water fabric can stand. If spots appear, rub in undiluted liquid detergent, let stand 30 minutes and rewash with extra detergent using hottest water fabric can stand.</p>
<p><b>GRAYED CLOTHES</b></p>	<ul style="list-style-type: none"> <li>• <b>Insufficient</b> detergent. You may need to increase amount of detergent used if load is larger than normal, if soils are oily or heavier than average, if water level is large or if water is Hard to Extremely Hard.</li> <li>• Water not hot enough for type of load. Be sure water heater is set to deliver hot water to the washer at 120°F.–150°F. (45°C.–65°C.). Do not wash when other hot water needs—such as dishwashing or family baths—are heavy.</li> <li>• Poor or inferior detergent. Change to phosphate detergent, if possible. Follow these steps:             <ol style="list-style-type: none"> <li>1. Use water conditioner (such as Calgon brand).</li> <li>2. Pretreat stains.</li> <li>3. Use the hottest water possible.</li> <li>4. Use bleach where possible.</li> <li>5. Use presoak aids.</li> <li>6. Install water softener.</li> </ol> </li> <li>• Washer overloaded. Clothes cannot move freely to loosen and remove soil, causing gray appearance. Follow correct loading procedures for size of load.</li> </ul>

*(continued next page)*



# THE PROBLEM SOLVER

(continued)

PROBLEM	POSSIBLE CAUSE
<b>GRAYED CLOTHES</b> (continued)	<ul style="list-style-type: none"><li>• <b>Improper</b> soaking with insufficient detergent. Usually a 30-minute soak is sufficient. However, when using extended soaks for heavily soiled garments, you may need to use twice the recommended amount of detergent.</li><li>• Use of soap in hard water. Switch to a phosphate detergent, or follow six steps at bottom of opposite page.</li><li>• Washing too long may result in increased soil deposition. Use shorter wash times for smaller loads.</li><li>• Detergent dissolves too slowly. Detergent must be present in the wash solution at the start of agitation. See Detergent and Additives section.</li><li>• To restore grayed clothes, follow one of these procedures:<ol style="list-style-type: none"><li>1. Put clothes in washer. Fill with HOT water. Check garment manufacturer's care labels to determine if hot water is suitable for garment.<ul style="list-style-type: none"><li>• Add a non-precipitating type of water softener such as Calgon brand. Use 2½ times as much as you need for normal water softening.</li><li>• Do not use detergent or soap.</li><li>• Allow clothes to go through complete cycle.</li><li>• Repeat, if necessary.</li></ul></li><li>2. If you prefer to use the Auto Soak cycle, see How to Use the Auto Soak Cycle section. Use the water softener in place of soak agent or prewash detergent and allow clothes to soak for about 20 minutes.</li><li>3. Use an extra cleaning cycle, see Tips to Help You Select Settings section.</li></ol></li></ul>
<b>YELLOWED CLOTHES</b>	<ul style="list-style-type: none"><li>• <b>Incomplete</b> removal of soil due to constant use of insufficient detergent. Check hem of T-shirt or pillow case. If they are white and center is yellow, it contains body oil. Restore whiteness following procedures in Grayed Clothes, above.</li><li>• Chlorine bleach may yellow some fabrics with resin finishes. Use oxygen bleach (such as Clorox 2 brand). Refer to garment manufacturer's care instructions. Restore color using color remover (such as Rit or Tintex brands), following package directions.</li><li>• <b>Iron</b> or manganese in water may cause overall yellowing or yellow spots.<ol style="list-style-type: none"><li>1. Use extra detergent plus a non-precipitating water softener dissolved in water before adding clothes. Use non-chlorine bleach.</li><li>2. Have a special filter installed in your home to remove iron and manganese from water.</li><li>3. Run hot water for a few minutes to clean iron residue buildup in lines; drain water heater occasionally.</li><li>4. <b>To remove spots:</b> Spread stained portion over pan of boiling water and squeeze lemon juice through stain. <b>To remove overall yellow,</b> use a commercially available rust scale remover, following package instructions. If porcelain damage can occur, do not use in the washer; use a plastic container,</li></ol></li></ul>
<b>BLUE OR GRAY COLOR STAINS</b>	<p><b>Improper</b> use of fabric softener. Never pour fabric softener directly on clothes; always dilute before adding to rinse water. See Other Laundry Products section. Also, do not lift lid during spin. This may cause improper dispensing, resulting in stains. <b>To remove stains:</b> Dampen stained area and rub with undiluted liquid detergent. Rewash, using chlorine bleach if safe for fabric.</p>
<b>SHRINKAGE, GENERAL</b>	<p>Some fabrics will shrink whether washed in a washer or by hand; others maybe safely washed but will shrink in a dryer. Follow garment manufacturer's care instructions exactly. If in doubt, do not machine wash or dry.</p>



PROBLEM	POSSIBLE CAUSE
<b>SHRINKAGE, KNITS</b>	<ul style="list-style-type: none"><li>• <b>Relaxation shrinkage can occur in knit fabrics that have been improperly stretched and elongated by the manufacturer. When this occurs, garment maybe pressed back into shape after each wash and dry cycle.</b></li><li>• <b>Progressive or delayed shrinkage</b> is caused when starch or sizing (in some fabrics) is gradually removed by laundering. This may also be noticed in older garments that have been washed many times without previous shrinkage. Treat as for relaxation shrinkage above.</li><li>• <b>Shrinkage caused by overheating</b> occurs in certain knit fabrics that have been heat-shaped. When washing, drying or ironing temperatures exceed the temperatures used to shape set, shrinkage may occur. This cannot be corrected, but it can be prevented by washing in cool or warm water and drying on low or delicate heat.</li></ul>
<b>WRINKLING IN PERMANENT PRESS AND “NO-IRON” ITEMS</b>	<ul style="list-style-type: none"><li>• Leaving clothes in dryer after tumbling stops. Remove and hang clothes immediately.</li><li>• Too many clothes in dryer. Dry only one washer load at a time. Do not combine loads.</li><li>• Improper loads. Avoid laundering heavy permanent press items, such as work clothes, with lighter permanent press items such as shirts or blouses. Do not wash permanent press items with regular laundry.</li><li>• Too many clothes in washer. Permanent press loads should always be smaller than regular loads... no more than medium loads to give clothes room to move freely.</li><li>• Incorrect wash and dry cycles. Use Permanent Press Wash cycle which provides a cooldown rinse to minimize wrinkling. Also use Permanent Press Dry cycle.</li><li>• Incorrect water level. Use larger water level for medium load, medium level for small load.</li><li>• Repeated washing in too hot water. Wash in cold or warm water with plenty of detergent.</li><li>• Failure to use fabric softener. Proper use will minimize wrinkling.</li></ul> <p><b>To remove wrinkles:</b></p> <ul style="list-style-type: none"><li>• Retumble on Permanent Press setting in your dryer.</li><li>• Rinse and dry on Permanent Press setting.</li><li>• If unsuccessful, retumble on high heat for 10 to 12 minutes and hang immediately.</li><li>• Send to dry cleaners for pressing.</li><li>• Some wrinkles may remain which cannot be removed.</li></ul>
<b>SNAGS, HOLES, TEARS, RIPS OR EXCESSIVE WEAR</b>	<ul style="list-style-type: none"><li>• Pins on garments or sharp objects left in pockets. Check to make sure all such objects are removed. Also check wash tub.</li><li>• Snaps, hooks, sharp buttons, belt buckles, zippers. Fasten hooks, zippers and buttons. Remove sharp buttons and belt buckles. This is especially important in washing knits which snag easily. Turn knits inside out.</li><li>• Holes with random square shapes with yellow discoloration may be caused by improper use of chlorine bleach. Use only correct amount of bleach. See Other Laundry Products section. Never add undiluted bleach to wash tub or allow clothes to come into contact with undiluted bleach. Do not wipe up bleach spills with clothes.</li><li>• Small, unnoticed tears may enlarge during washing process. Check garments before washing and mend all rips and tears.</li></ul>

(continued next page)



# THE PROBLEM SOLVER

(continued)

PROBLEM	POSSIBLE CAUSE
SNAGS, HOLES, TEARS, RIPS OR EXCESSIVE WEAR (continued)	<ul style="list-style-type: none"> <li>•Chemicals such as hair bleach, dye, permanent wave solutions, battery acids and toilet bowl cleaners may cause fabric holes. Rinse all towels and other articles that came in contact with these chemicals before putting them in wash. Do not contaminate clothing articles with these chemicals.</li> <li>•As permanent press garments age, they may show fraying at collars and cuffs. This is normal due to weakening of fibers by the permanent press process. It is not caused by washer. You can slow this process by washing small permanent press loads with a medium water level. Do not wash heavy items such as towels with permanent press. Remove collar stays, when possible.</li> <li>•May be caused by the use of Regular cycles for delicate articles. Use Permanent Press cycle. Refer to garment manufacturer's care labels.</li> <li>•Garments weakened by age, sun or atmosphere. This is inevitable and is not caused by washer.</li> <li>•Over loading or under loading washer for selected water level. Load washer only with number of items that will move freely. Select correct water level.</li> </ul>
HEAVILY SOILED AREAS such as collars and cuffs	Pretreat with liquid detergent. See Other Laundry Products section.
WASHER WON'T OPERATE	<div style="text-align: center; margin-bottom: 10px;"> </div> <ul style="list-style-type: none"> <li>•Make sure cord is plugged into outlet.</li> <li>•Make sure both hot and cold faucets are turned on.</li> <li>•Make sure controls are set and Cycle Selector knob is pulled out to ON position.</li> <li>•Make sure lid is closed. Washer will fill but will not spin or agitate with lid open.</li> <li>•Check house fuses or circuit breakers. If another appliance is sharing the electrical outlet, remove it. Washer should have separate outlet.</li> </ul>
WATER TEMPERATURE IS INCORRECT	<ul style="list-style-type: none"> <li>•Make sure temperature selector controls are correctly set.</li> <li>•Make sure hot and cold faucets are turned on and regulated correctly.</li> <li>•Make sure hoses are connected to correct faucets... hot to hot, cold to cold.</li> <li>•Water valve screens may be stopped up. Remove inlet hoses from water valve. Clean the screens and reinstall hoses.</li> <li>•Check house water heater to make sure it is delivering water at 120°F.-150°F. (45°C.-65°C.).</li> </ul> <div style="text-align: right; margin-top: 20px;"> </div>
WATER WON'T DRAIN	<ul style="list-style-type: none"> <li>•Make sure drain hose is not kinked.</li> <li>•Top of drain outlet should be less than 8 ft. (2.4 m) above floor.</li> </ul>



PROBLEM	POSSIBLE CAUSE
WATER LEAKS	<ul style="list-style-type: none"> <li>• Make sure hose connections are tight at faucets.</li> <li>• Make sure end of drain hose is correctly inserted in and secured to drain facility.</li> </ul>
WASHER IS NOISY	<ul style="list-style-type: none"> <li>• Make sure washer is level and firm to the floor with rubber foot pads in place and front jam nuts tight. See your Installation Instructions.</li> <li>• A sharp, distinctive sound will be heard at the end of each spin period as the motor stops and the spin brake inside the transmission "locks in." This sound is normal.</li> <li>• Heavily unbalanced loads can cause the washer to vibrate excessively during spin, and may cause it to move from its original position. In extreme cases (usually occurs when washing a single, heavy item or a small load when water level is set higher than necessary), the spin basket may strike the outer tub, creating a loud but harmless noise. To correct, stop the washer by pushing in the Cycle Selector knob, open the lid and redistribute the load evenly about the wash basket. Close the lid and restart.</li> </ul>
WASHER PAUSES IN CYCLE	<ul style="list-style-type: none"> <li>• Washer normally pauses between washing steps... such as between wash and spin or between spin and rinse.</li> </ul>

If you need more help...call, toll free: GE Answer Center™ / 800.626.2000 / consumer information service

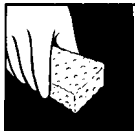

## CARE AND CLEANING

### USER MAINTENANCE INSTRUCTIONS

**The Tub.** The porcelain is self-cleaning. Leave lid open after washing to allow moisture to evaporate. Do not use harsh or gritty cleansers.

**The Exterior.** Wipe off any spills of washing compounds. Wipe or dust with damp cloth. Try not to hit surface with sharp objects.

**To Store Washer.** Ask service technician to remove water from drain pump and hoses to prevent freezing.

Do not store the washer where it will be exposed to the weather.

**For Long Vacations.** Be sure water supply is shut off at faucets and drain all water from hoses if weather will be below freezing.

### How to remove the agitator

To remove the agitator, snap the cap off and remove the screw. Then remove the agitator extender and the agitator.

To replace the agitator, carefully lower it straight down onto the shaft so that it fits snugly into place. Replace the agitator extender, the screw and the cap.

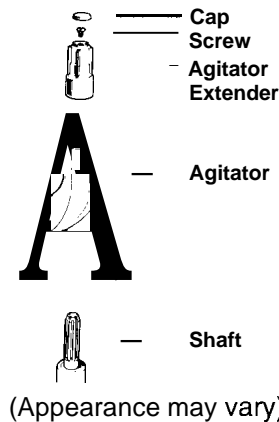

---

# NOTES

---

# NOTES

---

# NOTES

# We'll Be There

With the purchase of your new GE appliance, receive the assurance that if you ever need information or assistance from GE, we'll be there. All you have to do is call—toll-free!

## ***In-Home Repair Service*** ***800-GE-CARES (800-432-2737)***

AGE consumer service professional will provide expert repair service, scheduled at a time that's convenient for you. Many GE Consumer Service company-operated locations offer you service today or tomorrow, or at your convenience (7:00 a.m. to 7:00 p.m. weekdays, 9:00 a.m. to 2:00 p.m. Saturdays). Our factory-trained technicians know your appliance inside and out—so most repairs can be handled in just one visit.

## ***GE Answer Center®*** ***800.626.2000***

Whatever your question about any GE major appliance, GE Answer Center® information service is available to help. Your call—and your question—will be answered promptly and courteously. And you can call any time. GE Answer Center® service is open 24 hours a day, 7 days a week.

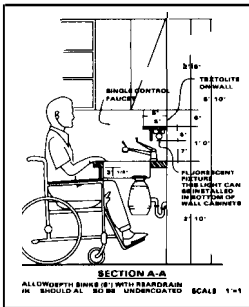

## ***For Customers With Special Needs...*** ***800.626.2000***

Upon request, GE will provide Braille controls for a variety of GE appliances, and a brochure to assist in planning a barrier-free kitchen for persons with limited mobility. To obtain these items, free of charge, call 800.626.2000.

Consumers with impaired hearing or speech who have access to a TDD or a conventional teletypewriter may call 800-TDD-GEAC (800-833-4322) to request information or service.

## ***Service Contracts*** ***800-626-2224***

You can have the secure feeling that GE Consumer Service will still be there after your warranty expires. Purchase a GE contract while your warranty is still in effect and you'll receive a substantial discount. With a multiple-year contract, you're assured of future service at today's prices.

## ***Parts and Accessories*** ***800.626.2002***

Individuals qualified to service their own appliances can have needed parts or accessories sent directly to their home. The GE parts system provides access to over 47,000 parts... and all GE Genuine Renewal Parts are fully warranted. VISA, MasterCard and Discover cards are accepted.

User maintenance instructions contained in this booklet cover procedures intended to be performed by any user. Other servicing generally should be referred to qualified service personnel. Caution must be exercised, since improper servicing may cause unsafe operation.

**YOUR GE AUTOMATIC  
CLOTHES WASHER  
WARRANTY**

**Staple sales slip or cancelled check  
here. Proof of original purchase date  
is needed to obtain service  
under warranty.**

**WHAT IS COVERED**

**FULL ONE-YEAR WARRANTY**

For one year from date of original purchase, we will provide, free of charge, parts and service labor in your home to repair or replace **any part of the** washer that fails because of a manufacturing defect.

**LIMITED ADDITIONAL  
FOUR-YEAR WARRANTY**

For the second through fifth year from date of original purchase, we will provide, free of charge, replacement parts for **any part of the transmission** that fails because of a manufacturing defect. You pay for the service trip to your home and service labor charges. Or, if you desire, we will provide a **completely reconditioned transmission**. You pay for the shop reconditioning labor, the service trip to your home and service labor charges.

This warranty is extended to the original purchaser and any succeeding owner for products purchased for ordinary home use in the 48 mainland states, Hawaii and Washington, D.C. In Alaska the warranty is the same except that it is LIMITED because you must pay to ship the product to the service shop or for the service technician's travel costs to your home.

All warranty service will be provided by our Factory Service Centers or by our authorized Customer Care® servicers during normal working hours.

Should your appliance need service, during warranty period or beyond, call 800-GE-CARES (800-432-2737).

**WHAT IS NOT COVERED**

- Service trips to your home to teach you how to use the product.

**Read your Use and Care material.**

If you then have any questions about operating the product, please contact your dealer or our Consumer Affairs office at the address below, or call, toll free:

GE Answer Center®  
800.626.2000  
consumer information service

- Improper installation.

if you have an installation problem, contact your dealer or installer. You are responsible for providing adequate electrical, plumbing and other connecting facilities.

- Replacement of house fuses or resetting of circuit breakers.
- Failure of the product if it is used for other than its intended purpose or used commercially.
- Damage to product caused by accident, fire, floods or acts of God.

**WARRANTOR IS NOT  
RESPONSIBLE FOR  
CONSEQUENTIAL DAMAGES.**

Some states do not allow the exclusion or limitation of incidental or consequential damages, so the above limitation or exclusion may not apply to you. This warranty gives you specific legal rights, and you may also have other rights which vary from state to state. To know what your legal rights are in your state, consult your local or state consumer affairs office or your state's Attorney General.

**Warrantor: General Electric Company**

**If further help is needed concerning this warranty, write:  
Manager—Consumer Affairs, GE Appliances, Louisville, KY 40225**

*This book is printed on recycled paper.*

Part No. 175D1807P049  
Pub No. 49-9818

8-94 CG

**WWA8620SC1**

Printed in Louisville, K