

This Owner's Manual is provided and hosted by [Appliance Factory Parts](#).



# LG GD1329LGD Owner's Manual

[Shop genuine replacement parts for LG GD1329LGD](#)



[Find Your LG Dryer Parts - Select From 451 Models](#)

----- Manual continues below -----



# OWNER'S MANUAL

# COMMERCIAL DRYER

Please read this manual carefully before operating your dryer and retain it for future reference.

## MODEL

GD1329CGS / GD1329CES  
GD1329CGU / GD1329CEU  
GD1329CGD / GD1329CED

GD1329QGS / GD1329QES  
GD1329QGU / GD1329QEU  
GD1329QGD / GD1329QED

[www.lg.com](http://www.lg.com)

P/NO. : MFL62512842

# PRODUCT FEATURES

## ■ OUTSTANDING PERFORMANCE

The dryer features the largest capacity, quick drying times, quiet operation, and an energy-saving system.

## ■ ARTISTIC DESIGN

Modern front panel look and big clear glass door make your dryer look stylish

## ■ EASY OF USE

An entire selection of user-friendly functions makes operating the dryer easy.

## ■ ULTRA CAPACITY

The larger drum enables better tumbling and less tangling and wrinkling of the laundry.

# CONTENTS

PART 1. IMPORTANT SAFETY INSTRUCTIONS .....	3
PART 2. SPECIFICATIONS .....	8
PART 3. IDENTIFICATION .....	9
PART 4. OPERATING YOUR DRYER .....	12
PART 5. PROGRAMMING MODE .....	13
PART 6. ERROR MODE .....	40
PART 7. POWER FAIL RECOVERY .....	40
PART 8. DEFAULT DRYER SETTINGS .....	40

## READ ALL INSTRUCTIONS BEFORE USE

**⚠ WARNING** For your safety, the information in this manual must be followed to minimize the risk of fire or explosion, electric shock, or to prevent property damage, injury to persons, or death.

### Your Safety and the safety of others is very important.

We have provided many important safety messages in this manual and on your appliance. Always read and obey all safety messages.



This is the safety alert symbol.

This symbol alerts you to potential hazards that can kill or hurt you and others.

All safety messages will follow the safety alert symbol and either the word DANGER or WARNING. These words mean:

**⚠ DANGER:** You can be killed or seriously injured if you don't immediately follow instructions.

**⚠ WARNING:** You can be killed or seriously injured if you don't follow instructions.

All safety messages will tell you what the potential hazard is, tell you how to reduce the chance of injury, and tell you what can happen if the instructions are not followed.

## BASIC SAFETY PRECAUTIONS

**⚠ WARNING:** To reduce the risk of fire, electric shock, or injury to persons when using this appliance, follow basic precautions, including the following:

- Read all instructions before using the dryer.
- Before use, the dryer must be properly installed as described in this manual.
- Do not place items exposed to cooking oils in your dryer. Items contaminated with cooking oils may contribute to a chemical reaction that could cause a load to catch fire.
- Do not dry articles that have been previously cleaned in, washed in, soaked in, or spotted with gasoline, dry-cleaning solvents, or other flammable or explosive substances as they give off vapors that could ignite or explode.
- Do not reach into the dryer if the drum or any other part is moving.
- Do not repair or replace any part of the dryer or attempt any servicing unless specifically recommended in this Use and Care Guide or in published user-repair instructions that you understand and have the skills to carry out.
- Do not tamper with controls.
- Before the dryer is removed from service or discarded, remove the door to the drying compartment.
- Do not allow children to play on or in the dryer. Close supervision of children is necessary when the dryer is used near children.
- Do not use fabric softeners or products to eliminate static unless recommended by the manufacturer of the fabric softener or product.
- Do not use heat to dry articles containing foam rubber or similarly textured rubber-like materials.
- Keep area around the exhaust opening and adjacent surrounding areas free from the accumulation of lint, dust, and dirt.
- The interior of the dryer and exhaust vent should be cleaned periodically by qualified service personnel.
- Do not install or store the dryer where it will be exposed to the weather.
- Always check the inside of the dryer for foreign objects.
- Clean lint screen before or after each load.
- Do not store plastic, paper, or clothing that may burn or melt on top of the dryer during operation.

## READ ALL INSTRUCTIONS BEFORE USE

**⚠ WARNING** For your safety, the information in this manual must be followed to minimize the risk of fire or explosion, electric shock, or to prevent property damage, injury to persons, or death.

- Do not store or use gasoline or other flammable vapors and liquids in the vicinity of this appliance or any other appliances.
- Installation and service must be performed by a qualified installer, service agency, or the gas supplier.

## WHAT TO DO IF YOU SMELL GAS:

1. Do not try to light a match or cigarette, or turn on any gas or electrical appliance.
2. Do not touch any electrical switches. Do not use any phone in your building.
3. Clear the room, building, or area of all occupants.
4. Immediately call your gas supplier from a neighbor's phone. Follow the gas supplier's instructions carefully.
5. If you cannot reach your gas supplier, call the fire department.

## CALIFORNIA SAFE DRINKING WATER AND TOXIC ENFORCEMENT ACT

This act requires the governor of California to publish a list of substances known to the state to cause cancer, birth defects, or other reproductive harm and requires businesses to warn customers of potential exposure to such substances.

Gas appliances can cause minor exposure to four of these substances, namely benzene, carbon monoxide, formaldehyde, and soot, caused primarily by the incomplete combustion of natural gas or LP fuels.

Properly adjusted dryers will minimize incomplete combustion. Exposure to these substances can be minimized further by properly venting the dryer to the outdoors.

## READ ALL INSTRUCTIONS BEFORE USE

**⚠ WARNING** For your safety, the information in this manual must be followed to minimize the risk of fire or explosion, electric shock, or to prevent property damage, injury to persons, or death.

### GROUNDING INSTRUCTIONS

This appliance must be grounded. In the event of malfunction or breakdown, grounding will reduce the risk of electric shock by providing a path of least resistance for electric current. This appliance must be equipped with a cord having an equipment-grounding conductor and a grounding plug. The plug must be plugged into an appropriate outlet that is properly installed and grounded in accordance with all local codes and ordinances.

Do not modify the plug provided with the appliance. If it will not fit the outlet, have a proper outlet installed by a qualified electrician.

This appliance must be connected to a grounded metal, permanent wiring system or an equipment-grounding conductor must be run with the circuit conductors and connected to the equipment-grounding terminal or lead on the appliance.

Electric shock can result if the dryer is not properly grounded.

**⚠ WARNING** — Improper connection of the equipment-grounding conductor can result in a risk of electric shock. Check with a qualified electrician or service person if you are in doubt as to whether the appliance is properly grounded.

### SAFETY INSTRUCTIONS FOR INSTALLATION

**⚠ WARNING** To reduce the risk of fire, electric shock, or injury to persons when using this appliance, follow basic precautions, including the following:

- **Properly ground dryer to conform with all governing codes and ordinances. Follow details in the installation instructions.** Electric shock can result if the dryer is not properly grounded.
- **Before use, the dryer must be properly installed as described in this manual.** Electric shock can result if the dryer is not properly grounded.
- **Install and store the dryer where it will not be exposed to temperatures below freezing or exposed to the weather.**
- **All repairs and servicing must be performed by an authorized servicer unless specifically recommended in this Owner's Guide. Use only authorized factory parts.** Failure to follow this warning can cause serious injury, fire, electric shock, or death.
- **To reduce the risk of electric shock, do not install the dryer in humid spaces.** Failure to follow this warning can cause serious injury, fire, electric shock, or death.
- **Connect to a properly rated, protected, and sized power circuit to avoid electrical overload.** Improper power circuit can melt, creating electric shock and/or fire hazard.
- **Remove all packing items and dispose of all shipping materials properly.** Failure to do so can result in death, explosion, fire, or burns.
- **Place dryer at least 18 in. above the floor for a garage installation.** Failure to do so can result in death, explosion, fire, or burns.
- **Keep all packaging from children. Packaging material can be dangerous for children.** There is a risk of suffocation.
- **Keep the area underneath and around your appliances free of combustible materials such as lint, paper, rags, chemicals, etc.** Failure to do so can result in fire.
- **Do not place candles, smoking materials, or other flammables on top of the product.** Dripping wax, smoke, or fire can result.
- **Remove all protective vinyl film from the product.** Failure to do so can cause product damage, smoke or fire.

## READ ALL INSTRUCTIONS BEFORE USE

**⚠ WARNING** For your safety, the information in this manual must be followed to minimize the risk of fire or explosion, electric shock, or to prevent property damage, injury to persons, or death.

### SAFETY INSTRUCTIONS FOR INSTALLATION

#### Exhaust/Ducting:

- **Gas dryers MUST be exhausted to the outside.** Failure to follow these instructions can result in fire or death.
- **The dryer exhaust system must be exhausted to the outside of the dwelling. If the dryer is not exhausted outdoors, some fine lint and large amounts of moisture will be expelled into the laundry area.** An accumulation of lint in any area of the home can create a health and fire hazard.
- **Use only rigid metal or flexible metal 4-in. diameter ductwork inside the dryer cabinet or for exhausting to the outside. Use of plastic or other combustible ductwork can cause a fire.** Punctured ductwork can cause a fire if it collapses or becomes otherwise restricted in use or during installation.
- **Ductwork is not provided with the dryer, and you should obtain the necessary ductwork locally. The end cap should have hinged dampers to prevent backdraft when the dryer is not in use.** Failure to follow these instructions can result in fire or death.
- **The exhaust duct must be 4 in. (10 cm) in diameter with no obstructions. The exhaust duct should be kept as short as possible. Make sure to clean any old ducts before installing your new dryer.** Failure to follow these instructions can result in fire or death.
- **Rigid or semi rigid metal ducting is recommended for use between the dryer and the wall. In special installations when it is impossible to make a connection with the above recommendations, a UL-listed flexible metal transition duct may be used between the dryer and wall connection only. The use of this ducting will affect drying time.** Failure to follow these instructions can result in fire or death.
- **DO NOT use sheet metal screws or other fasteners which extend into the duct that could catch lint and reduce the efficiency of the exhaust system. Secure all joints with duct tape. For complete details, follow the Installation Instructions.** Failure to follow these instructions can result in fire or death.

## READ ALL INSTRUCTIONS BEFORE USE

**⚠ WARNING** For your safety, the information in this manual must be followed to minimize the risk of fire or explosion, electric shock, or to prevent property damage, injury to persons, or death.

### SAFETY INSTRUCTIONS FOR CONNECTING ELECTRICITY

**⚠ WARNING:** To reduce the risk of fire, electric shock, or injury to persons when using this appliance, follow basic precautions, including the following:

- **Do not, under any circumstances, cut or remove the ground prong from the power cord.** To prevent injury to persons or damage to the dryer, the electrical power cord must be plugged into a properly grounded outlet.
- **For personal safety, this dryer must be properly grounded.** Failure to do so can result in electric shock or injury.
- **Refer to the installation instructions in this manual for specific electrical requirements for your model.** Failure to follow these instructions can create an electric shock hazard and/or a fire hazard.
- **This dryer must be plugged into a properly grounded outlet. Electric shock can result if the dryer is not properly grounded. Have the wall outlet and circuit checked by a qualified electrician to make sure the outlet is properly grounded.** Failure to follow these instructions can create an electric shock hazard and/or a fire hazard.
- **The dryer should always be plugged into its own individual electrical outlet which has a voltage rating that matches the rating plate.** This provides the best performance and also prevents overloading house wiring circuits which could cause a fire hazard from overheated wires.
- **Never unplug your dryer by pulling on the power cord. Always grip plug firmly and pull straight out from the outlet.** The power cord can be damaged, resulting in a risk of fire and electric shock.
- **Repair or replace immediately all power cords that have become frayed or otherwise damaged. Do not use a cord that shows cracks or abrasion damage along its length or at either end.** The power cord can melt, creating electric shock and/or fire hazard.
- **When installing or moving the dryer, be careful not to pinch, crush, or damage the power cord.** This will prevent injury and prevent damage to the dryer from fire and electric shock.
- **To reduce the risk of injury to persons, adhere to all industry recommended safety procedures including the use of long sleeved gloves and safety glasses.** Failure to follow all of the safety warnings in this manual could result in property damage, injury to persons or death.

**SAVE THESE INSTRUCTIONS**



- Type : Electric and Gas Dryer
  - Rating : Please refer to the rating label regarding detailed information.
  - Size : 686mm(W) x 764mm(D) x 983mm(H)  
27"(W) X 30 <sup>3</sup>/<sub>4</sub>"(D) X 38 <sup>11</sup>/<sub>16</sub>"(H)
  - Capacity : IEC 7.1 cu.ft. (22.5 lb)
  - Weight : 131 lbs (59.4 kg)
- \* Specifications are subject to change by manufacturer.

**Note**

Specifications subject to change by manufacturer.

## ■ CARD TYPE

- SIDE BY SIDE(GD1329CGS, GD1329CES)
- STACK UPPER(GD1329CGU, GD1329CEU)
- STACK LOWER(GD1329CGD, GD1329CED)

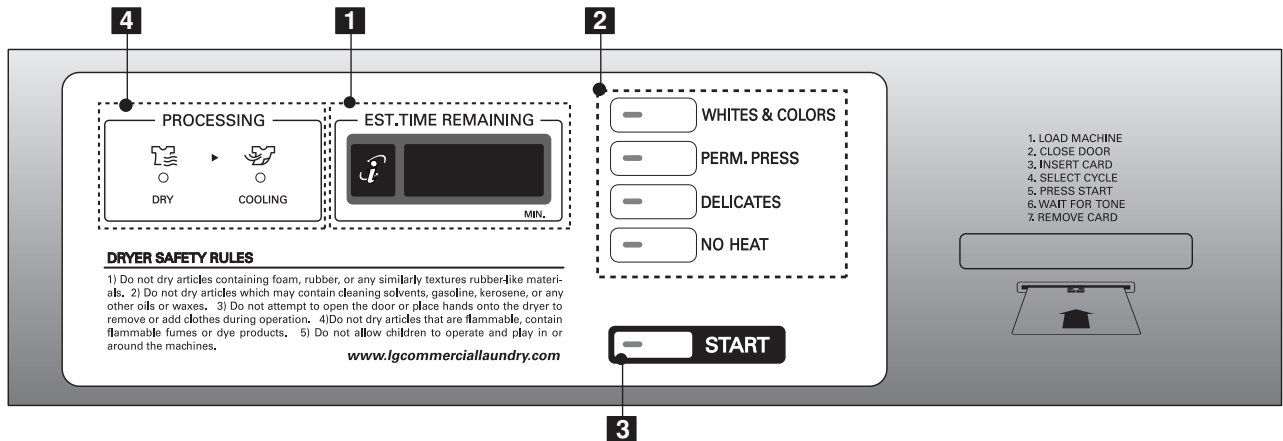

## ■ COIN TYPE

- SIDE BY SIDE(GD1329QGS, GD1329QES)

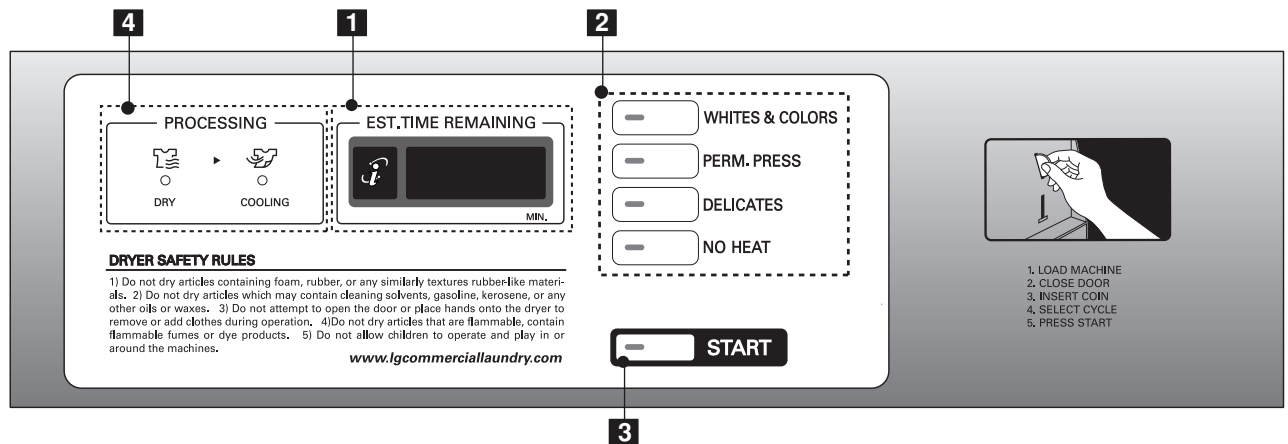

1. DISPLAY LED
2. CYCLE BUTTON

3. START BUTTON
4. STATUS LED

■ COIN TYPE

- STACK UPPER(GD1329QGU, GD1329QEU)

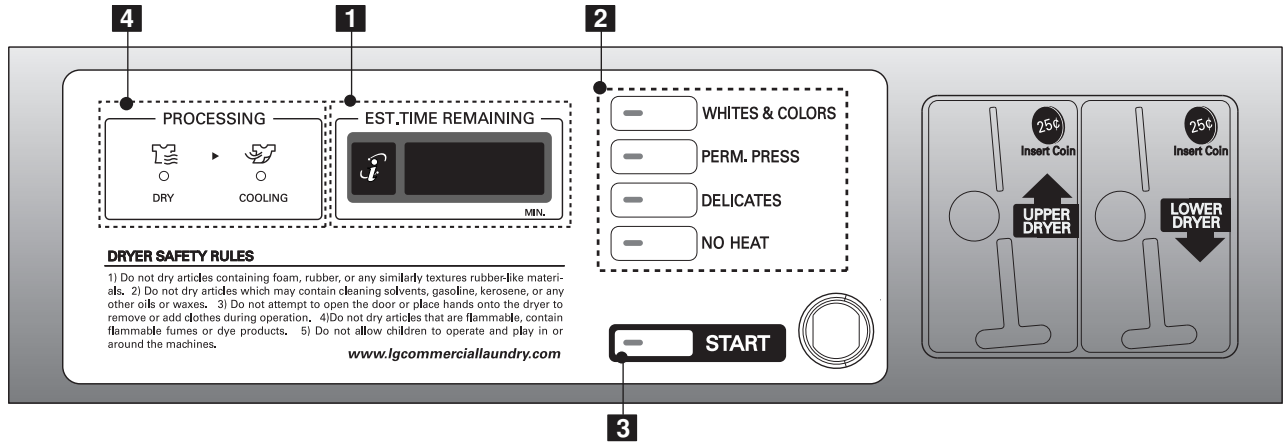

■ COIN TYPE

- STACK LOWER(GD1329QGD, GD1329QED)

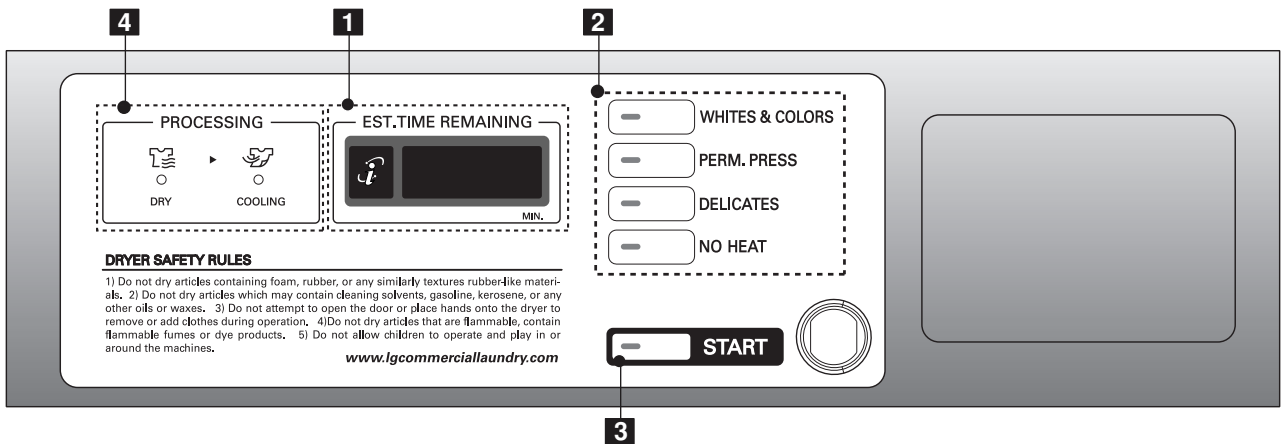

- 1. DISPLAY LED
- 2. CYCLE BUTTON

- 3. START BUTTON
- 4. STATUS LED

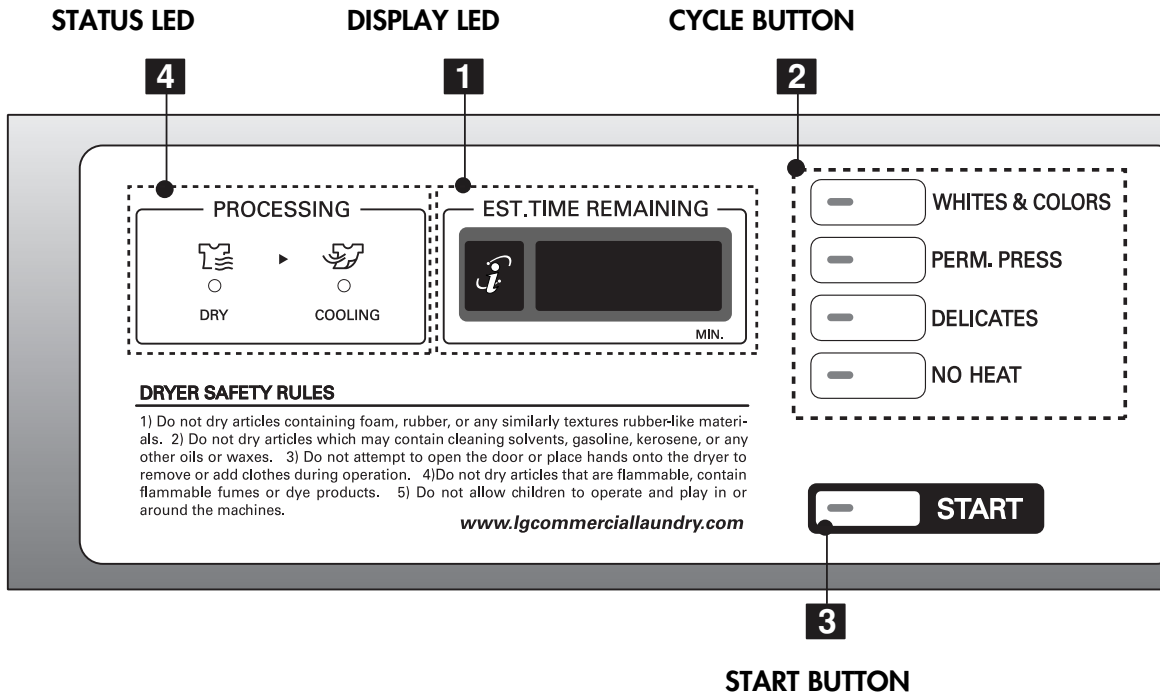

**1 DISPLAY LED**

The Display shows the vend price, remaining time, and programming options.

Error codes are also displayed here.



**2 CYCLE BUTTON**

Press the cycle button to Select the desired cycle based on laundry types and conditions.

**WHITES & COLORS**

Use this cycle to get high heat for heavy fabrics, such as jeans corduroys or work clothes (High heat).

**PERM. PRESS**

Use for drying sturdy fabrics such as work casual clothes (Medium heat).

**DELICATES**

Use for drying synthetic fabrics, washable knit fabrics and no-iron finishes (Low heat).

**NO HEAT**



Use for items that require heat-free drying such as plastics or rubber.

**3 START BUTTON**

The START LED flashes when the full vend price has been satisfied then the cycle has been chosen or the machine is paused.

The START LED flashes when a card is inserted to add time to the current cycle.

**4 STATUS LED**

-  LED flashes whenever the heating cycle is in operation.
-  LED flashes whenever the cool down cycle is in operation.

## 1 Ready mode

The display LED shows each cycle price and cycle LED toggle.

## 2 Insert card/coin

- Insert a cash card that has a sufficient balance. The card balance should be more than the programmed vend price for a selected cycle.

### Note

When the card balance is not enough, machine displays the balance for 5 seconds and then displays **ERR** message repetitively

- Insert a sufficient amount of change that is a more than the programmed vend price for a selected cycle.

### Note

When the coin amount is not enough, the machine will not start.

## 3 Select the cycle

Press the desired cycle and the start button. The display LED will show the remaining time and the selected cycle starts.

### Note

The last 2 minutes of the remaining time are always for the cool down portion.

## 4 Top off (To add more time)

- After a debit card is inserted, the operating time can be increased to 15 minutes/25¢ (default), when the START button or the chosen course button has been pressed. (The card should have enough balance to satisfy increasing time.)
- The operating time can be increased to 15 minutes/25¢ (default) by adding more coins.

### Note

Owner can control the additional time and money setting (top off price).

When the COOL DOWN has been working, if time is added, it goes back to the DRYING. Time can be added up 99 minutes.

## 5 Change cycle

- You cannot change the cycle while the machine is running.
- But if the door is opened, the machine stops temporarily and the cycle can be changed.

## 6 Cycle finish

- After the COOL DOWN of cycle, the machine stops and LED display shows End. If you press any key or open the door, the dryer defaults to the ready mode.

**1 Programming mode**

You can check machine information or change setting on Program setup or Diagnostic test. There are two methods that you can enter programming mode.

**2 Check the programming mode by button**

■ **How to enter "Programming mode"**

You can enter programming mode only for Idle state and pause state.

- **Card Type**

- 1) Insert service card.
- 2) Display will show **8888**

- **Coin Type**

- 1) Disassemble upper coin box key.
- 2) Take out the coin drop from the coin box.
- 3) Turn on/off the toggle switch at the back of the coin box.
- 4) Display will show “ **8888** ”.

■ **How to use button**

You can change Dryer vend price, cycle time and Cycle parameters, etc.

Press button	Description
WHITES & COLORS	Move to upper level
PERM. PRESS	Move to the mode in the same level (+)
DELICATES	Move to the modes in the same level (-)
NO HEAT	-
START	Enter the selected mode

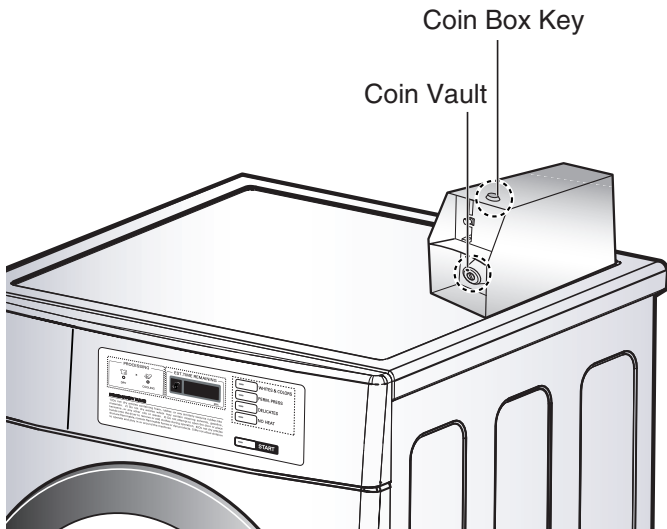

COIN TYPE

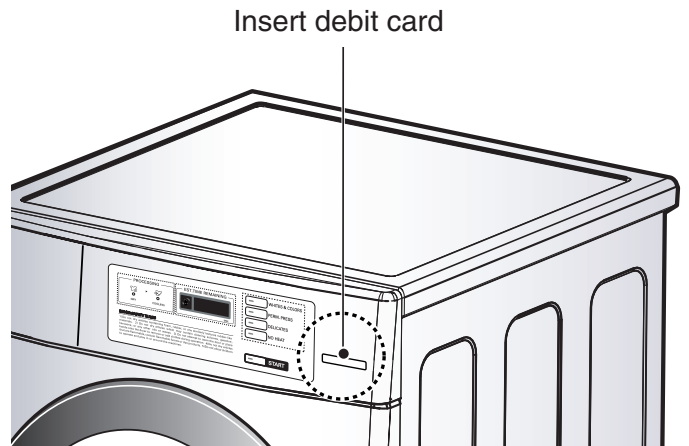

CARD TYPE

**Note**

- If you turn on the power without connecting the meter case for the first time, the machine will display **8888**.
- When the machine comes from the factory, it is set in the coin type. You can change Card/Coin type by button. (For more information refer to SETUP mode's **FEA1**.)

■ Algorithm Flow Chart shows how to control programming mode.

■ Before program set, check the structure of programming mode.

1. Turn on/off toggle switch or Insert the service card to entering set up mode.
2. Press **WHITES & COLORS** button to move the upper level.
3. Press **PERM. PRESS(+)** or **DELICATES(-)** button if you want to be at the same level.
4. Press **START** button to enter the details of Set up, Diagnostic Tests mode.

**SE UP** is to set price value, time value and vend type etc.

**EE SE** consists of line test, reset, free cycle and kill cycle.

**EE EE** is to collect the usage data.

■ STRUCTURE OF PROGRAMMING MODE

<b>SE UP</b>		<b>EE SE</b>		<b>EE EE</b>		
SPPA	SP EE	U9C1	U9C1	SPPA	AC AC	TE AD
SPCP	SP AC	U9C2	U9C2	SPCP	AC CC	TE UC
SPAP	SP AC	U1FE	U1FE	SPAP	AC AC	TE AC
SPHP	EE EE	EE PE	EE PE	SPHP	AC HC	TE db
SPPA	AA PE	U13E	U13E	DE UC	AC SC	TE Cb
SPCP	BB PE	COUP	COUP	TE AC	AC TF	TE db
SPAP	ES SB	KILL	KILL	TE CC	AC UC	TE Cb
SPHP	CC db			TE AC	AC FC	SC PA
SCPA	CC db			TE HC	AC PE	TE PA
SPCE	PI PA			TE SC	TE AP	TE ED
TEA1	TE PE			TE EF	TE TB	TE AD
SPPA	BE EP			TE UC	TE PA	TE ED
SPBE	TE FA			TE FC	TE db	AC ED









Note

- Do not use **U9C2**, **U1FE**.
- It is only used in inspecting the machine.

**Setup Mode :  (display)**

- You can change dryer vend price, cycle time, and cycle parameters, etc.
- Entering set up mode
  - Coin type - Turn on/off toggle switch.
  - Card type - Insert the service card.
  - Stack type - Take off control panel, and turn on/off toggle switch.
  - Then, dryer displays .









**1 How to change regular price.**

	Button	Display
Entering set up mode. You will see LqC1  	Press the <b>WHITES &amp; COLORS</b> button.	
	Press the <b>PERM. PRESS</b> or the <b>DELICATES</b> button until  appears in the display.	
	Press the <b>START</b> button.	
	Press the <b>START</b> button. Display previous regular price.	
	Press <b>PERM. PRESS(+)</b> or <b>DELICATES(-)</b> button to set regular price. (The vend price can be set from 0 to \$9.95 in 5¢ increments.)	
	Press the <b>START</b> button. The machine sets up the regular price, then advances to the next process automatically.	
	1. Continue to set up the next price. 2. Stop the change of setup value and go back to ready mode. <ul style="list-style-type: none"> <li>• Coin type - Turn on/off toggle switch.</li> <li>• Card type - Pull the service card.</li> <li>• Stack type - 1. Control panel open. 2. Turn on/off toggle switch.</li> </ul>	

**Note**

- rgCP (regular cold price) is not available in dryer.
- rgrP (regular warm price) is not available in dryer.
- rgHP (regular hot price) is not available in dryer.





2 How to change special price

	Button	Display
<p>Entering set up mode. You will see LqC1</p> 	<p>Press the <b>WHITES &amp; COLORS</b> button.</p>	
	<p>Press the <b>PERM. PRESS</b> or the <b>DELICATES</b> button until <b>SEUP</b> appears in the display.</p>	
	<p>Press the <b>START</b> button.</p>	
	<p>Press the <b>PERM. PRESS</b> or the <b>DELICATES</b> button until <b>SPPP</b> appears in the display.</p>	
	<p>Press the <b>START</b> button. Display previous special price.</p>	
	<p>Press <b>PERM. PRESS(+)</b> or <b>DELICATES(-)</b> button to set special price. (The vend price can be set from 0 to \$9.95 in 5¢ increments.)</p>	
	<p>Press the <b>START</b> button. The machine sets up the regular price, then advances to the next process automatically.</p>	
	<p>1. Continue to set up the next price. 2. Stop the change of setup value and go back to ready mode.</p> <ul style="list-style-type: none"> <li>• Coin type - Turn on/off toggle switch.</li> <li>• Card type - Pull the service card.</li> <li>• Stack type - 1. Control panel open. 2. Turn on/off toggle switch.</li> </ul>	

Note

- SPCP (special cold price) is not available in dryer.
- SPPrP (special warm price) is not available in dryer.
- SPHP (special hot price) is not available in dryer.
- SCPA (add super cycle price) is not available in dryer.
- SPCT (add super wash type) is not available in dryer.

3 How to enter the **FEA1**

Button	Display
Entering set up mode. You will see LqC1  	
Press the <b>WHITES &amp; COLORS</b> button.	
Press the <b>PERM. PRESS</b> or the <b>DELICATES</b> button until <b>SEUP</b> appears in the display.	
Press the <b>START</b> button.	
Press the <b>PERM. PRESS</b> or the <b>DELICATES</b> button until <b>FEA1</b> appears in the display.	

■ Structure of **FEA1**

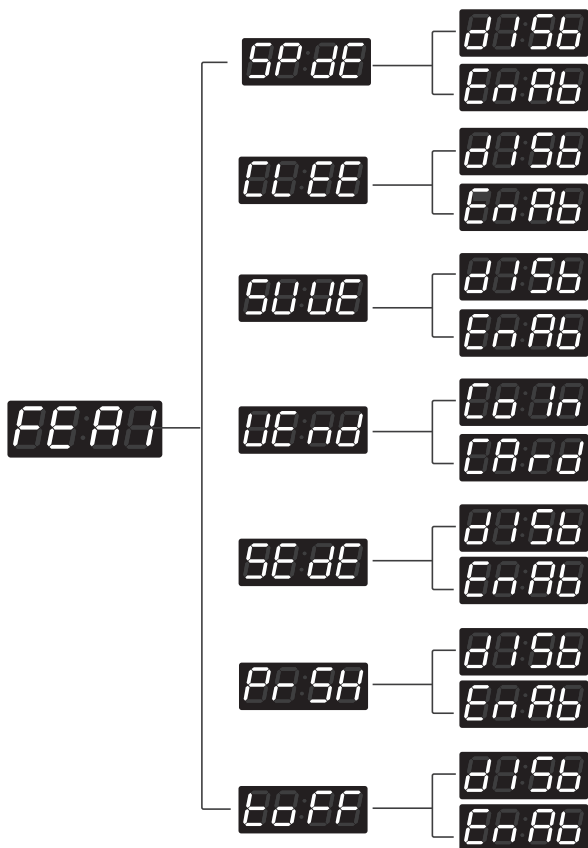

■ Content of **FEA1**

- SPDE** • Special price days apply or not

---

- CLEE** • Clear escrow enable or not (coin type only)

---

- SUUE** • Add super wash apply or not

---

- UEND** • Select vend type

---

- SEDE** • Sense dry apply or not (only for dryer)

---

- PRSH** • Pre-wash apply or not

---

- TOPF** • Top off apply or not (only for dryer)

---











- d15b** • Disable

---

- EnAb** • Enable

---











## 3-1 Special price day setup

	Button	Display
Entering set up mode. You will see LqC1 	Press the <b>WHITES &amp; COLORS</b> button.	
	Press the <b>PERM. PRESS</b> or the <b>DELICATES</b> button until <b>SEUP</b> appears in the display.	
	Press the <b>START</b> button.	
	Press the <b>PERM. PRESS</b> or the <b>DELICATES</b> button until <b>FEA</b> appears in the display.	
	Press the <b>START</b> button. Display <b>SP 00</b> .	
	Press the <b>START</b> button. Press <b>PERM. PRESS</b> or <b>DELICATES</b> button and then select <b>0156</b> or <b>EA AB</b> .   Disable  Enable	One or the other will display.   
	Press the <b>START</b> button. The machine sets up the special price, then advances to the next process automatically.	
	1. Continue to set up the next mode. 2. Stop the change of setup value and go back to ready mode. <ul style="list-style-type: none"> <li>• Coin type - Turn on/off toggle switch.</li> <li>• Card type - Pull the service card.</li> <li>• Stack type - 1. Control panel open. 2. Turn on/off toggle switch.</li> </ul>	

**Note**

- CLEE (clear escrow enable or not) is not available in dryer.
- SUUE (add super wash apply or not) is not available in dryer.













**3-2** Vend type setup - card type or coin type setup

	Button	Display
<p>Entering set up mode. You will see LqC1</p> 	<p>Press the <b>WHITES &amp; COLORS</b> button.</p>	
	<p>Press the <b>PERM. PRESS</b> or the <b>DELICATES</b> button until <b>SEUP</b> appears in the display.</p>	
	<p>Press the <b>START</b> button.</p>	
	<p>Press the <b>PERM. PRESS</b> or the <b>DELICATES</b> button until <b>FEA1</b> appears in the display.</p>	
	<p>Press the <b>START</b> button. Display <b>SPdE</b> .</p>	
	<p>Press the <b>PERM. PRESS</b> or the <b>DELICATES</b> button until <b>UEAd</b> appears in the display.</p>	
	<p>Press the <b>START</b> button. Press <b>PERM. PRESS</b> or <b>DELICATES</b> button and then select <b>CoIn</b> or <b>CArD</b> .</p>  Coin type  Card type	<p>One or the other will display.</p>  
	<p>Press the <b>START</b> button. The machine sets up the vend type, then go to the idle mode automatically.</p>	







**Note**

- SEdE (sensor dry apply or not) is not available in dryer.
- PrSH (Pre-wash apply or not) is not available in dryer.

**3-3** Top off apply or not setup

	Button	Display
<p>Entering set up mode. You will see LqC1</p> 	<p>Press the <b>WHITES &amp; COLORS</b> button.</p>	
	<p>Press the <b>PERM. PRESS</b> or the <b>DELICATES</b> button until <b>SEUP</b> appears in the display.</p>	
	<p>Press the <b>START</b> button.</p>	
	<p>Press the <b>PERM. PRESS</b> or the <b>DELICATES</b> button until <b>FEA1</b> appears in the display.</p>	
	<p>Press the <b>START</b> button. Display <b>SP:00</b>.</p>	
	<p>Press the <b>PERM. PRESS</b> or the <b>DELICATES</b> button until <b>LoFF</b> appears in the display.</p>	
	<p>Press the <b>START</b> button. Press <b>PERM. PRESS</b> or <b>DELICATES</b> button and then select <b>d156</b> or <b>EAAb</b>.</p>  Disable  Enable	<p>One or the other will display.</p>  
	<p>Press the <b>START</b> button. The machine sets up the Vend type, then advances to the next process automatically.</p>	
	<ol style="list-style-type: none"> <li>Continue to set up the next mode.</li> <li>Stop the change of setup value and go back to ready mode.                             <ul style="list-style-type: none"> <li>Coin type - Turn on/off toggle switch.</li> <li>Card type - Pull the service card.</li> <li>Stack type - 1. Control panel open. 2. Turn on/off toggle switch.</li> </ul> </li> </ol>	







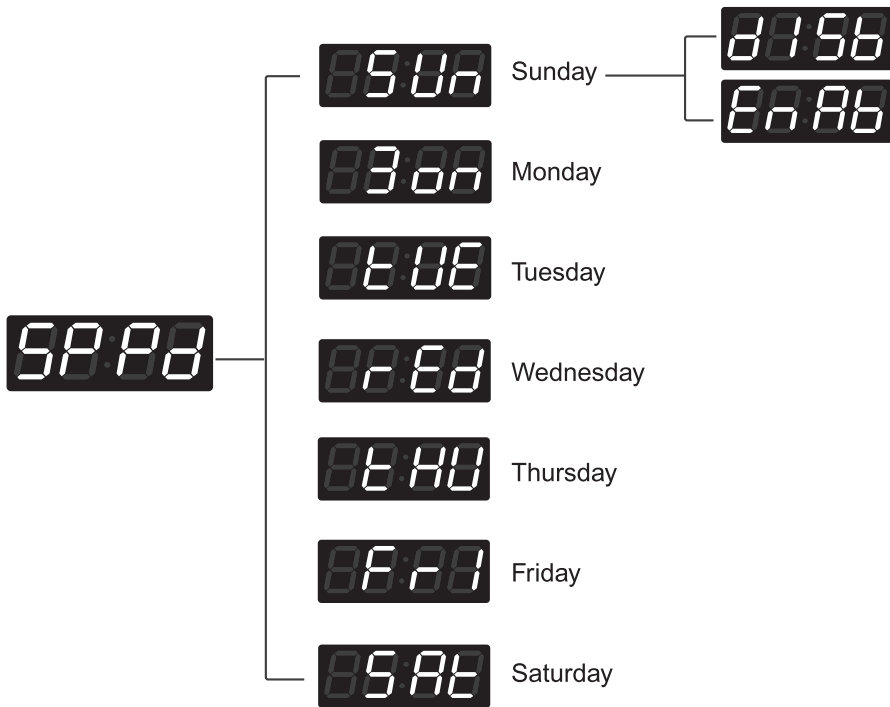



4 How to enter the special price day setup

	Button	Display
Entering set up mode. You will see LqC1  	Press the <b>WHITES &amp; COLORS</b> button.	
	Press the <b>PERM. PRESS</b> or the <b>DELICATES</b> button until <b>SEUP</b> appears in the display.	
	Press the <b>START</b> button.	
	Press the <b>PERM. PRESS</b> or the <b>DELICATES</b> button until <b>SPPd</b> appears in the display.	
	Press the <b>START</b> button. Display <b>SUn</b> .	

■ Structure of **SPPd**









4-1 How to change sunday

	Button	Display
<p>Entering set up mode. You will see LqC1</p> 	<p>Press the <b>WHITES &amp; COLORS</b> button.</p>	
	<p>Press the <b>PERM. PRESS</b> or the <b>DELICATES</b> button until <b>SE UP</b> appears in the display.</p>	
	<p>Press the <b>START</b> button.</p>	
	<p>Press the <b>PERM. PRESS</b> or the <b>DELICATES</b> button until <b>SPPA</b> appears in the display.</p>	
	<p>Press the <b>START</b> button. Display <b>SUN</b>.</p>	
<p>Press the <b>START</b> button. Press <b>PERM. PRESS(+)</b> or <b>DELICATES</b> button and then select <b>0156</b> or <b>EA AB</b>.</p>  <p>Disable</p>  <p>Enable</p>	<p>One or the other will display.</p>  	
	<p>Press the <b>START</b> button. The machine sets up the special price day (Sunday), then advances to the next process automatically.</p>	
	<p>1. Continue to set up the next mode. 2. Stop the change of setup value and go back to ready mode.</p> <ul style="list-style-type: none"> <li>• Coin type - Turn on/off toggle switch.</li> <li>• Card type - Pull the service card.</li> <li>• Stack type - 1. Control panel open. 2. Turn on/off toggle switch.</li> </ul>	







Note

As explained on the previous page, other days can be set up by the same method.

## 5 Special price beginning time setup

	Button	Display
Entering set up mode. You will see LqC1 	Press the <b>WHITES &amp; COLORS</b> button.	
	Press the <b>PERM. PRESS</b> or the <b>DELICATES</b> button until <b>SEUP</b> appears in the display.	
	Press the <b>START</b> button.	
	Press the <b>PERM. PRESS</b> or the <b>DELICATES</b> button until <b>SP6E</b> appears in the display.	
	Press the <b>START</b> button. Display previous special price beginning time.	
	Press <b>PERM. PRESS(+)</b> or <b>DELICATES(-)</b> button to select time between <b>0</b> and <b>23</b> .	
	Press the <b>START</b> button. The machine sets up the special price beginning time, then advances to the next process automatically.	
	1. Continue to set up the next mode. 2. Stop the change of setup value and go back to ready mode. <ul style="list-style-type: none"> <li>• Coin type - Turn on/off toggle switch.</li> <li>• Card type - Pull the service card.</li> <li>• Stack type - 1. Control panel open. 2. Turn on/off toggle switch.</li> </ul>	







## 6 Special price ending time setup

	Button	Display
<p>Entering set up mode. You will see LqC1</p> 	Press the <b>WHITES &amp; COLORS</b> button.	
	Press the <b>PERM. PRESS</b> or the <b>DELICATES</b> button until <b>SE UP</b> appears in the display.	
	Press the <b>START</b> button.	
	Press the <b>PERM. PRESS</b> or the <b>DELICATES</b> button until <b>SPEE</b> appears in the display.	
	Press the <b>START</b> button. Display previous special price ending time.	
	Press <b>PERM. PRESS(+)</b> or <b>DELICATES(-)</b> button to select time between 1 and 24.	
	Press the <b>START</b> button. The machine sets up the special price ending time, then advances to the next process automatically.	
	1. Continue to set up the next mode. 2. Stop the change of setup value and go back to ready mode. <ul style="list-style-type: none"> <li>• Coin type - Turn on/off toggle switch.</li> <li>• Card type - Pull the service card.</li> <li>• Stack type - 1. Control panel open. 2. Turn on/off toggle switch.</li> </ul>	







### Note

When setting up a special price period, the ending time must be later than the beginning time.

## 7 Regular priced dryer cycle time

	Button	Display
Entering set up mode. You will see LqC1 	Press the <b>WHITES &amp; COLORS</b> button.	
	Press the <b>PERM. PRESS</b> or the <b>DELICATES</b> button until <b>SE UP</b> appears in the display.	
	Press the <b>START</b> button.	
	Press the <b>PERM. PRESS</b> or the <b>DELICATES</b> button until <b>RP 80</b> appears in the display.	
	Press the <b>START</b> button. Display previous regular priced dryer cycle time.	
	Press <b>PERM. PRESS(+)</b> or <b>DELICATES(-)</b> button to select time between <b>10</b> and <b>99</b> .	
	Press the <b>START</b> button. The machine sets up the regular priced dryer cycle time, then advances to the next process automatically.	
	1. Continue to set up the next mode. 2. Stop the change of setup value and go back to ready mode. <ul style="list-style-type: none"> <li>• Coin type - Turn on/off toggle switch.</li> <li>• Card type - Pull the service card.</li> <li>• Stack type - 1. Control panel open. 2. Turn on/off toggle switch.</li> </ul>	







## 8 Special priced dryer cycle time

	Button	Display
Entering set up mode. You will see LqC1 	Press the <b>WHITES &amp; COLORS</b> button.	
	Press the <b>PERM. PRESS</b> or the <b>DELICATES</b> button until <b>SEUP</b> appears in the display.	
	Press the <b>START</b> button.	
	Press the <b>PERM. PRESS</b> or the <b>DELICATES</b> button until <b>SPdC</b> appears in the display.	
	Press the <b>START</b> button. Display previous special priced dryer cycle time.	
	Press <b>PERM. PRESS(+)</b> or <b>DELICATES(-)</b> button to select time between <b>10</b> and <b>99</b> .	
	Press the <b>START</b> button. The machine sets up the special priced dryer cycle time, then advances to the next process automatically.	
	1. Continue to set up the next mode. 2. Stop the change of setup value and go back to ready mode. <ul style="list-style-type: none"> <li>• Coin type - Turn on/off toggle switch.</li> <li>• Card type - Pull the service card.</li> <li>• Stack type - 1. Control panel open. 2. Turn on/off toggle switch.</li> </ul>	







### Note

- CCCC (washing time) is not available in dryer.
- nrPC (rinsing times per cycle) is not available in dryer.
- rt (rinsing time setup) is not available in dryer.
- tSSd (top spin speed) is not available in dryer.

## 9 Value of coin 1

	Button	Display
Entering set up mode. You will see LqC1 	Press the <b>WHITES &amp; COLORS</b> button.	
	Press the <b>PERM. PRESS</b> or the <b>DELICATES</b> button until <b>SEUP</b> appears in the display.	
	Press the <b>START</b> button.	
	Press the <b>PERM. PRESS</b> or the <b>DELICATES</b> button until <b>Co1</b> appears in the display.	
	Press the <b>START</b> button. Display previous coin 1 value.	
	Press <b>PERM. PRESS(+)</b> or <b>DELICATES(-)</b> button to select value of coin 1 (The value can be set from 0 to 9.95 in 5¢ increments.)	
	Press the <b>START</b> button. The machine sets up the value of coin 1, then advances to the next process automatically.	
	<ol style="list-style-type: none"> <li>1. Continue to set up the next mode.</li> <li>2. Stop the change of setup value and go back to ready mode.               <ul style="list-style-type: none"> <li>• Coin type - Turn on/off toggle switch.</li> <li>• Card type - Pull the service card.</li> <li>• Stack type - 1. Control panel open. 2. Turn on/off toggle switch.</li> </ul> </li> </ol>	

### 10 Value of coin 2 (Set up for top off price and e-suds coin pulse)







	Button	Display
Entering set up mode. You will see LqC1 	Press the <b>WHITES &amp; COLORS</b> button.	
	Press the <b>PERM. PRESS</b> or the <b>DELICATES</b> button until <b>SEUP</b> appears in the display.	
	Press the <b>START</b> button.	
	Press the <b>PERM. PRESS</b> or the <b>DELICATES</b> button until <b>C02</b> appears in the display.	
	Press the <b>START</b> button. Display previous coin 2 value.	
	Press <b>PERM. PRESS(+)</b> or <b>DELICATES(-)</b> button to select value of coin 2 (The value can be set from 0 to 9.95 in 5¢ increments.)	
	Press the <b>START</b> button. The machine sets up the value of coin 2, then advances to the next process automatically.	
	1. Continue to set up the next mode. 2. Stop the change of setup value and go back to ready mode. <ul style="list-style-type: none"> <li>• Coin type - Turn on/off toggle switch.</li> <li>• Card type - Pull the service card.</li> <li>• Stack type - 1. Control panel open. 2. Turn on/off toggle switch.</li> </ul>	

#### Note

- Coin type : Value of coin 2 is same function as setting for the e-Suds coin pulse.
- Card type : Value of coin 2 is same function as the top off price.  
(As changing the value of coin 2, you can change the top off price and e-Suds coin pulse.)

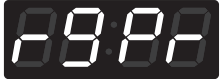
### 11 Penny increment pricing offset







This represents the cent increment price offset used when debit card is setup.

	Button	Display
Entering set up mode. You will see LqC1 	Press the <b>WHITES &amp; COLORS</b> button.	
	Press the <b>PERM. PRESS</b> or the <b>DELICATES</b> button until <b>SEUP</b> appears in the display.	
	Press the <b>START</b> button.	
	Press the <b>PERM. PRESS</b> or the <b>DELICATES</b> button until <b>PIPo</b> appears in the display.	
	Press the <b>START</b> button. Display previous penny increment pricing offset.	
	Press <b>PERM. PRESS(+)</b> or <b>DELICATES(-)</b> button to select value of PIPo. (0~4)	
	Press the <b>START</b> button. The machine sets up the PIPo, then advances to the next process automatically.	
	1. Continue to set up the next mode. 2. Stop the change of setup value and go back to ready mode. <ul style="list-style-type: none"> <li>• Coin type - Turn on/off toggle switch.</li> <li>• Card type - Pull the service card.</li> <li>• Stack type - 1. Control panel open. 2. Turn on/off toggle switch.</li> </ul>	







#### Note

- Penny increment pricing offset is available only in card type.  
(It hasn't affected on the coin type's price setting.)







12 Top off time

	Button	Display
<p>Entering set up mode. You will see LqC1</p> 	<p>Press the <b>WHITES &amp; COLORS</b> button</p>	
	<p>Press the <b>PERM. PRESS</b> or the <b>DELICATES</b> button until <b>SETUP</b> appears in the display.</p>	
	<p>Press the <b>START</b> button.</p>	
	<p>Press the <b>PERM. PRESS</b> or the <b>DELICATES</b> button until <b>TOP OFF</b> appears in the display.</p>	
	<p>Press the <b>START</b> button. Display previous top off time.</p>	
	<p>Press <b>PERM. PRESS(+)</b> or <b>DELICATES(-)</b> button to select time between <b>1</b> and <b>30</b>.</p>	
	<p>Press the <b>START</b> button. The machine sets up the top off time, then advances to the next process automatically.</p>	
	<ol style="list-style-type: none"> <li>1. Continue to set up the next mode.</li> <li>2. Stop the change of setup value and go back to ready mode.                             <ul style="list-style-type: none"> <li>• Coin type - Turn on/off toggle switch.</li> <li>• Card type - Pull the service card.</li> <li>• Stack type - 1. Control panel open. 2. Turn on/off toggle switch.</li> </ul> </li> </ol>	

## 13 Beep volume

	Button	Display
Entering set up mode. You will see LqC1 	Press the <b>WHITES &amp; COLORS</b> button	
	Press the <b>PERM. PRESS</b> or the <b>DELICATES</b> button until <b>SEUP</b> appears in the display.	
	Press the <b>START</b> button.	
	Press the <b>PERM. PRESS</b> or the <b>DELICATES</b> button until <b>BEER</b> appears in the display.	
	Press the <b>START</b> button. Display previous value.	
	Press <b>PERM. PRESS(+)</b> or <b>DELICATES(-)</b> button to select High or Low or Off.	
	Press the <b>START</b> button. The machine sets up the beep volume, then advances to the next process automatically.	
	1. Continue to set up the next mode. 2. Stop the change of setup value and go back to ready mode. <ul style="list-style-type: none"> <li>• Coin type - Turn on/off toggle switch.</li> <li>• Card type - Pull the service card.</li> <li>• Stack type - 1. Control panel open. 2. Turn on/off toggle switch.</li> </ul>	

**14** Time to keep the coin (Use only for coin type)

	Button	Display
<p>Entering set up mode. You will see LqC1</p> 	<p>Press the <b>WHITES &amp; COLORS</b> button</p>	
	<p>Press the <b>PERM. PRESS</b> or the <b>DELICATES</b> button until <b>SEUP</b> appears in the display.</p>	
	<p>Press the <b>START</b> button.</p>	
	<p>Press the <b>PERM. PRESS</b> or the <b>DELICATES</b> button until <b>FEFF</b> appears in the display.</p>	
	<p>Press the <b>START</b> button. Display previous value.</p>	
	<p>Press <b>PERM.PRESS(+)</b> or <b>DELICATES(-)</b> button to select time between 1 ~ 180 or 'Disable'.</p>	
	<p>Press the <b>START</b> button. The machine sets up the time to keep the coin, then advances to the next process automatically.</p>	
	<ol style="list-style-type: none"> <li>1. Continue to set up the next mode.</li> <li>2. Stop the change of setup value and go back to ready mode. <ul style="list-style-type: none"> <li>• Coin type - Turn on/off toggle switch.</li> <li>• Card type - Pull the service card.</li> <li>• Stack type - 1. Control panel open. 2. Turn on/off toggle switch.</li> </ul> </li> </ol>	

Diagnostic tests : **EE5E** (display)

This program has been added for testing the dryer and detecting errors.

## Entering the test mode

Data Name	Button	Display	Description
Entering the test mode	1. Entering programming mode	<b>L9C1</b>	Insert service card (card type), Turn on/off toggle switch (Coin type).
	2. WHITES & COLORS	<b>EE5E</b>	Press the WHITES & COLORS button. Then <b>EE5E</b> appears in the display.
	3. START	<b>L9C1</b>	Enter the diagnostic test mode.

1 **L9C1**

Pressing the **START** button cycles to the next test function.





Number of times the START button is pressed	Checking point	Display
None		LqC 1
1 time	Check the version and code of machine. ■ ELECTRIC TYPE : CA:0E ■ GAS TYPE : CA:0g	Version and code of machine (All LED on) Display CA:0E or CA:0g and gU:XX alternately. XX is the version number.
2 times	PDA CHECK	Ir--
3 times	Motor runs.	Measured moisture value (70~239)
4 times	■ ELECTRIC TYPE: Heater runs. Motor + Heater 1 (2700W) ■ GAS TYPE: GAS valve runs. Motor + Valve	Current temperature (5~70) (Displays the temperature inside the drum in ° Celsius.)
5 times	■ ELECTRIC TYPE: Heater runs. Motor + Heater 1 +Heater 2 (5400W) ■ GAS TYPE: GAS valve runs. Motor+Valve	Current temperature (5~70) (Displays the temperature inside the drum in ° Celsius.)
6 times	LED & KEY CHECK Press WHITES & COLORS button. Press PERM. PRESS button. Press DELICATES button. Press NO HEAT button	Version and code of machine
7 times	Test ends.	LqC1
During check, if the door is open.	Door switch (Motor & Heater Off, Buzzer beeps seven times)	dE (The door is open. Please close the door completely)
During check, if the door is closed	Test goes back at step 2. (Motor on & Heater Off)	Measured moisture value (70~239)

## Note

During LqC1 test, if no buttons are pressed for 4 minutes, machine will be turned off automatically.  
Do not use **L9C2**.

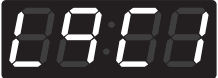
**2** Factory reset - EEPT













After a factory reset, all values are reset to the default values.

	Button	Display
<p>Entering set up mode. You will see LqC1</p> 	<p>Press the <b>PERM. PRESS</b> or the <b>DELICATES</b> Button until <b>EEPT</b> appears in the display.</p>	
	<p>Press the <b>START</b> button.</p>	
	<p>Press the <b>PERM. PRESS</b> button until <b>00:23</b> appears in the display.</p>	
	<p>Press the <b>START</b> button, then factory reset is done. <b>L9C1</b> is displayed.</p>	
	<p>1. Continue to set up the next mode. 2. Stop the change of setup value and go back to ready mode.</p> <ul style="list-style-type: none"> <li>• Coin type - Turn on/off toggle switch.</li> <li>• Card type - Pull the service card.</li> <li>• Stack type - 1. Control panel open. 2. Turn on/off toggle switch.</li> </ul>	

**Note**









- Dryer default value
  - Drying time            45 Minute
  - Top off time            15 Minute

## 3 Time Set Up

	Button	Display
Entering set up mode. You will see LqC1 	Press the <b>PERM. PRESS</b> or the <b>DELICATES</b> button until  appears in the display.	
	Press the <b>START</b> button. <b>The display cycles through 2000 --&gt; 0101 --&gt; Sat --&gt; 0000.</b>	
	Press the <b>START</b> button.	
	Press <b>PERM. PRESS (+)</b> or <b>DELICATES(-)</b> button to select year between <b>2000</b> and <b>2099</b> .	
	Press the <b>START</b> button. The machine sets up the year, then advances to the next process automatically.	
	Press <b>PERM. PRESS (+)</b> or <b>DELICATES(-)</b> button to select month between <b>01</b> and <b>12</b> .	
	Press the <b>START</b> button. The machine sets up the month, then advances to the next process automatically.	
	Press <b>PERM. PRESS (+)</b> or <b>DELICATES(-)</b> button to select day between <b>01</b> and <b>31</b> .	
	Press the <b>START</b> button. The machine sets up the day, then advances to the next process automatically.	
	Press <b>PERM. PRESS (+)</b> or <b>DELICATES(-)</b> button to select hour between <b>00</b> and <b>23</b> .	
	Press the <b>START</b> button. The machine sets up the hour, then advances to the next process automatically.	
	Press <b>PERM. PRESS (+)</b> or <b>DELICATES(-)</b> button to select minute between <b>00</b> and <b>59</b> .	
	Press the <b>START</b> button. The machine sets up the minute.	
	<ol style="list-style-type: none"> <li>Continue to set up the next mode.</li> <li>Stop the change of setup value and go back to ready mode.               <ul style="list-style-type: none"> <li>Coin type - Turn on/off toggle switch.</li> <li>Card type - Pull the service card.</li> <li>Stack type - 1. Control panel open. 2. Turn on/off toggle switch.</li> </ul> </li> </ol>	





**4** Courtesy cycle

Courtesy cycle is like a complimentary cycle given to the customer when the dryer goes out of order when the customer has made the payment to dry one's clothes.



	Button	Display
<p>Entering set up mode. You will see LqC1</p> 	<p>Press the <b>PERM. PRESS</b> or the <b>DELICATES</b> Button until  appears in the display.</p>	
	<p>Press the <b>START</b> button.</p>	
	<p>Press the <b>PERM. PRESS</b> button until  appears in the display.</p>	
	<p>Press the <b>START</b> button. Display will show .</p>	
	<p>Select the course you desire.</p> <p><b>Note</b></p> <ul style="list-style-type: none"> <li>In case of dryer card type, it has to insert the cash card after removing the service card. Then press the cycle course and the start button. (It is only applicable to the dryer's card type specially and there is no subtraction in card balance at the Courtesy cycle.)</li> </ul>	
	<p>Press the <b>START</b> button. Display will show the remaining time and start.</p>	

## 5 Cycle Kill

## ■ Coin type

	Button	Display
Entering set up mode. You will see LqC1  	Press the <b>PERM. PRESS</b> or the <b>DELICATES</b> Button until <b>HILL</b> appears in the display.	
	Press the <b>START</b> button.	
	Press the <b>PERM. PRESS</b> button until <b>00:17</b> appears in the display.	
	Press the <b>START</b> button.	
	Display <b>End</b> with beeping.	
	Go back to ready mode.	

## ■ Card type

	Descriptions	Display
Insert cycle kill card.	Display the current time and <b>done</b> .	
	Display <b>End</b> with beeping.	
	Go back to ready mode.	

**Collect Information Data : CLCt (display)**

The dryer collects the usage data so that the owner can check various information like number of various cycles used, how many times card or coins used, etc.

**Entering the collect mode**

Data Name	Step (Button)	LED Display	Description
Entering the collect mode	1. Entering the programming mode.	LRCH	Insert service card(card type), Turn on/off toggle switch (Coin type).
	2. WHITES & COLORS	EESE	Press the WHITES & COLORS button until "tEst" appears in the display.
	3. DELICATES	CLCE	Press the PERM. PRESS or DELICATES button until "CLCt" appears in the display.
	4. START	rgPr	Enter the Collect information data.
	5. PERM. PRESS or DELICATES		Move to each data list that you want to check by pressing with PERM. PRESS or DELICATES button.
	6. START		Display the value of selected data list

❖ Check the collect information reference to the follow lists. The Lists are displayed by abbreviations.

■ **Collect Mode Data lists**

No.	Abbreviation	Meaning	Description
1	rgPr	Regular Price	0~199 nickels (\$0.00~\$9.95)
2	rgCP	Regular Cold Price	rgCP is not available in dryer. (It can't enter.)
3	rgrP	Regular Warm Price	rgrP is not available in dryer. (It can't enter.)
4	rgHP	Regular Hot Price	rgHP is not available in dryer. (It can't enter.)
5	dELC	Dryer Moisture Sense	dELC is not available in dryer. (It can't enter.)
6	ltrC	Interval Regular Cycles	Number of Regular cycles ( 0~65535 )
7	ltrCC	Interval Regular Cold Cycles	ltrCC is not available in dryer. (It can't enter.)
8	ltrAC	Interval Regular Warm Cycles	ltrAC is not available in dryer. (It can't enter.)
9	ltrHC	Interval Regular Hot Cycles	ltrHC is not available in dryer. (It can't enter.)
10	ltrSC	Interval Super Cycles	ltrSC is not available in dryer. (It can't enter.)
11	ltrF	Interval Topoff Cycles (Dryer Only)	Number of Topoff cycles ( 0~65535 )
12	ltrUC	Interval Service Cycles	Number of Service cycles (0~65535)
13	ltrFC	Interval Token Cycles	Number of Token cycles (0~65535)
14	ACrC	Accumulated Regular Cycles	Number of Regular cycles ( 0~65535 )
15	ACCC	Accumulated Regular Cold Cycles	ACCC is not available in dryer. (It can't enter.)
16	ACAC	Accumulated Regular Warm Cycles	ACAC is not available in dryer. (It can't enter.)
17	ACHC	Accumulated Regular Hot Cycles	ACHC is not available in dryer. (It can't enter.)
18	ACSC	Accumulated Super Cycles (Washer Only)	ACSC is not available in dryer. (It can't enter.)
19	ACtF	Accumulated Topoff Cycles (Dryer Only)	Number of Topoff cycles ( 0~65535 )
20	ACUC	Accumulated Service Cycles	Number of Service cycles ( 0~65535 )
21	ACFC	Accumulated Token Cycles	Number of Token cycles (0~65535)
22	ACrt	Accumulated Run Time	Number of Running minutes ( 0~65535 )

### ■ Collect Mode Data lists

No.	Abbreviation	Meaning	Description
23	ltnr	Interval No Runs	ltnr is not available in dryer.
24	ltdb	Interval Trouble Cycles	ltdb is not available in dryer.
25	ltpd	Interval Power Downs	Number of power down
26	ltd	Interval Unauthorized Service Door Openings	Number of Unauthorized Service Door Openings ( 0~ 255)
27	lta	Interval Authorized Service Door Openings	Number of Unauthorized Service Door Openings ( 0~ 255)
28	luc	Interval Unauthorized Coin Vault Openings	Number of Authorized Service Door Openings ( 0~ 255)
29	lac	Interval Authorized Coin Vault Openings	Number of Authorized Service Door Openings ( 0~ 255)
30	tl	Time of Last Service Door Opening	tl is not available in dryer.(It can't enter.)
31	tlc	Time of Last Coin Vault Opening	tlc is not available in dryer.(It can't enter.)
32	tp	Time of Previous Service Door Opening	tp is not available in dryer.(It can't enter.)
33	tpc	Time of Previous Coin Vault Opening	tpc is not available in dryer.(It can't enter.)
34	scpr	Super Cycle Price	Scpr is not available in dryer. (It can't enter.)
35	to	Top Off Price	0~199 nickels (\$.00~\$9.95)
36	ltd	Interval Money	Amount of money for regular cycle(\$0 ~ \$65535)
37	acd	Accumulated Money	Amount of money for regular cycle(\$0 ~ \$65535)
38	ltd	Interval Topoff Money	Amount of money for Topoff(\$0 ~ \$65535)
39	actd	Accumulated Topoff Money	Amount of money for Topoff(\$0 ~ \$65535)

\* INTERVAL means collecting since last data collection.

\* ACCUMULATED means collecting over a period of time since last factory reset (EEPt).

\* Authorized: Turning on/off the toggle switch with PDA Communication.  
(Turning on/off the toggle switch within 30 minutes after Communicating with PDA)

\* Unauthorized: Turning on/off the toggle switch without PDA Communication.

\* These items (No.30~33) are not applied this program.

## Part 6

## ERROR MODE

### ■ Meaning of Error Codes that LED displays during occurrence or problem.

#### Dryer error code

PROBLEM	POSSIBLE CAUSE	SOLUTION
EE1	It is displayed when thermistor is open.	Thermistor should be replaced.
EE2	It is displayed when thermistor is shorted.	Thermistor should be replaced.
CAE	Disconnection of card reader wire.	Check the card reader wire.

## Part 7

## POWER FAIL RECOVERY

In case of power failure the machine stops running but the time display remains on, showing the time just before power failure.

Press the **START** button after the power is restored, then the machine will restart.

## Part 8

## DEFAULT DRYER SETTINGS

Default Settings	Default
Cycle Time (Minutes)	45 Minutes
Cool Down Time Cycle	2 Minutes
High Temperature	154.4° F (68° C)
Medium Temperature	140° F (60° C)
Low Temperature	125.6° F (52.5° C)
Top Off Time (Minutes per coin)	15 Minutes
Coin #1 Value	25¢
Coin #2 Value	25¢
Minutes/Minutes and seconds	Minutes
Fahrenheit/Celsius	Fahrenheit
Error Mode	On

# MEMO

# MEMO

# MEMO

